

P5NSLI *Series*

P5NSLI

P5NSLI/WiFi

ASUS[®]

Motherboard

E2234

**First Edition
August 2006**

Copyright © 2006 ASUSTeK COMPUTER INC. All Rights Reserved.

No part of this manual, including the products and software described in it, may be reproduced, transmitted, transcribed, stored in a retrieval system, or translated into any language in any form or by any means, except documentation kept by the purchaser for backup purposes, without the express written permission of ASUSTeK COMPUTER INC. ("ASUS").

Product warranty or service will not be extended if: (1) the product is repaired, modified or altered, unless such repair, modification or alteration is authorized in writing by ASUS; or (2) the serial number of the product is defaced or missing.

ASUS PROVIDES THIS MANUAL "AS IS" WITHOUT WARRANTY OF ANY KIND, EITHER EXPRESS OR IMPLIED, INCLUDING BUT NOT LIMITED TO THE IMPLIED WARRANTIES OR CONDITIONS OF MERCHANTABILITY OR FITNESS FOR A PARTICULAR PURPOSE. IN NO EVENT SHALL ASUS, ITS DIRECTORS, OFFICERS, EMPLOYEES OR AGENTS BE LIABLE FOR ANY INDIRECT, SPECIAL, INCIDENTAL, OR CONSEQUENTIAL DAMAGES (INCLUDING DAMAGES FOR LOSS OF PROFITS, LOSS OF BUSINESS, LOSS OF USE OR DATA, INTERRUPTION OF BUSINESS AND THE LIKE), EVEN IF ASUS HAS BEEN ADVISED OF THE POSSIBILITY OF SUCH DAMAGES ARISING FROM ANY DEFECT OR ERROR IN THIS MANUAL OR PRODUCT.

SPECIFICATIONS AND INFORMATION CONTAINED IN THIS MANUAL ARE FURNISHED FOR INFORMATIONAL USE ONLY, AND ARE SUBJECT TO CHANGE AT ANY TIME WITHOUT NOTICE, AND SHOULD NOT BE CONSTRUED AS A COMMITMENT BY ASUS. ASUS ASSUMES NO RESPONSIBILITY OR LIABILITY FOR ANY ERRORS OR INACCURACIES THAT MAY APPEAR IN THIS MANUAL, INCLUDING THE PRODUCTS AND SOFTWARE DESCRIBED IN IT.

Products and corporate names appearing in this manual may or may not be registered trademarks or copyrights of their respective companies, and are used only for identification or explanation and to the owners' benefit, without intent to infringe.

Contents

Notices	vii
Safety information	viii
About this guide.....	ix
How this guide is organized.....	ix
Where to find more information	ix
Conventions used in this guide.....	x
Typography.....	x
P5NLI and P5NSLI/WiFi specifications summary	xi

Chapter 1: Product introduction

1.1	Welcome!	1-2
1.2	Package contents	1-2
1.3	Special features	1-3
1.3.1	Product highlights	1-3
1.3.2	Innovative ASUS features	1-5
1.4	Before you proceed	1-7
1.5	Motherboard overview	1-8
1.5.1	Placement direction	1-8
1.5.2	Screw holes.....	1-8
1.5.3	Motherboard layout	1-9
1.6	Central Processing Unit (CPU)	1-10
1.6.1	Installing the CPU.....	1-10
1.6.2	Installing the CPU heatsink and fan.....	1-13
1.6.3	Uninstalling the CPU heatsink and fan.....	1-15
1.7	System memory.....	1-17
1.7.1	Overview	1-17
1.7.2	Memory configurations	1-17
1.7.3	Installing a DIMM	1-20
1.7.4	Removing a DIMM.....	1-20
1.8	Expansion slots	1-21
1.8.1	Installing an expansion card	1-21
1.8.2	Configuring an expansion card	1-21
1.8.3	Interrupt assignments.....	1-22
1.8.4	PCI slots	1-23
1.8.5	PCI Express x1 slot	1-23

Contents

- 1.8.6 Two PCI Express x16 slots..... 1-24
- 1.9 Jumpers 1-25
- 1.10 Connectors 1-27
 - 1.10.1 Rear panel connectors 1-27
 - 1.10.2 Internal connectors..... 1-28

Chapter 2: BIOS setup

- 2.1 Managing and updating your BIOS 2-2
 - 2.1.1 Creating a bootable floppy disk 2-2
 - 2.1.2 Updating the BIOS..... 2-3
 - 2.1.3 Saving the current BIOS file 2-5
 - 2.1.4 ASUS CrashFree BIOS 2 utility 2-6
 - 2.1.5 ASUS EZ Flash utility 2-8
 - 2.1.6 ASUS Update utility 2-9
- 2.2 BIOS setup program..... 2-12
 - 2.2.1 BIOS menu screen..... 2-13
 - 2.2.2 Menu bar 2-13
 - 2.2.3 Legend bar 2-14
 - 2.2.4 Menu items 2-14
 - 2.2.5 Sub-menu items 2-14
 - 2.2.6 Configuration fields 2-14
 - 2.2.7 Pop-up window..... 2-15
 - 2.2.8 General help 2-15
- 2.3 Main menu..... 2-16
 - 2.3.1 System Time 2-16
 - 2.3.2 System Date 2-16
 - 2.3.3 Legacy Diskette A 2-16
 - 2.3.4 Primary and Secondary IDE Master/Slave 2-17
 - 2.3.5 SATA 1-4 2-19
 - 2.3.6 HDD SMART Monitoring..... 2-20
 - 2.3.7 Installed Memory..... 2-20
 - 2.3.8 Usable Memory..... 2-20
- 2.4 Advanced menu 2-21
 - 2.4.1 JumperFree Configuration..... 2-21
 - 2.4.2 LAN Cable Status..... 2-26

Contents

2.4.3	CPU Configuration	2-27
2.4.4	Chipset.....	2-28
2.4.5	PCIePnP	2-30
2.4.6	Onboard Devices Configuration.....	2-30
2.4.7	USB Configuration	2-34
2.5	Power menu	2-35
2.5.1	ACPI Suspend Type	2-35
2.5.2	ACPI APIC Support	2-35
2.5.3	APM Configuration	2-36
2.5.4	Hardware Monitor.....	2-38
2.6	Boot menu	2-39
2.6.1	Boot Device Priority	2-39
2.6.2	Removable Drives.....	2-40
2.6.3	Hard Disk Drives.....	2-40
2.6.4	CDROM Drives	2-41
2.6.5	Boot Settings Configuration	2-41
2.6.6	Security.....	2-43
2.7	Tools menu	2-45
2.7.1	ASUS Music Alarm.....	2-45
2.7.2	ASUS O.C. Profile	2-47
2.7.3	ASUS EZ Flash 2.....	2-49
2.8	Exit menu.....	2-50

Chapter 3: Software Support

3.1	Installing an operating system	3-2
3.2	Support CD information	3-2
3.2.1	Running the support CD	3-2
3.2.2	Drivers menu.....	3-3
3.2.3	Utilities menu	3-4
3.2.4	Make Disk menu	3-5
3.2.5	Manuals menu	3-6
3.2.6	ASUS Contact information	3-7
3.3	Software information.....	3-8
3.3.1	ASUS Music Alarm.....	3-8
3.4	NVIDIA® SLI™ technology	3-8
3.4.1	Requirements	3-11

3.4.2	Dual graphics card setup	3-12
-------	--------------------------------	------

Appendix: CPU features

A.1	Intel® EM64T.....	A-1
A.2	Enhanced Intel SpeedStep® Technology (EIST)	A-1
	A.2.1 System requirements.....	A-1
	A.2.2 Using the EIST	A-2
A.3	Intel® Hyper-Threading Technology	A-3

Notices

Federal Communications Commission Statement

This device complies with Part 15 of the FCC Rules. Operation is subject to the following two conditions:

- This device may not cause harmful interference, and
- This device must accept any interference received including interference that may cause undesired operation.

This equipment has been tested and found to comply with the limits for a Class B digital device, pursuant to Part 15 of the FCC Rules. These limits are designed to provide reasonable protection against harmful interference in a residential installation. This equipment generates, uses and can radiate radio frequency energy and, if not installed and used in accordance with manufacturer's instructions, may cause harmful interference to radio communications. However, there is no guarantee that interference will not occur in a particular installation. If this equipment does cause harmful interference to radio or television reception, which can be determined by turning the equipment off and on, the user is encouraged to try to correct the interference by one or more of the following measures:

- Reorient or relocate the receiving antenna.
- Increase the separation between the equipment and receiver.
- Connect the equipment to an outlet on a circuit different from that to which the receiver is connected.
- Consult the dealer or an experienced radio/TV technician for help.



The use of shielded cables for connection of the monitor to the graphics card is required to assure compliance with FCC regulations. Changes or modifications to this unit not expressly approved by the party responsible for compliance could void the user's authority to operate this equipment.

Canadian Department of Communications Statement

This digital apparatus does not exceed the Class B limits for radio noise emissions from digital apparatus set out in the Radio Interference Regulations of the Canadian Department of Communications.

This class B digital apparatus complies with Canadian ICES-003.

Safety information

Electrical safety

- To prevent electrical shock hazard, disconnect the power cable from the electrical outlet before relocating the system.
- When adding or removing devices to or from the system, ensure that the power cables for the devices are unplugged before the signal cables are connected. If possible, disconnect all power cables from the existing system before you add a device.
- Before connecting or removing signal cables from the motherboard, ensure that all power cables are unplugged.
- Seek professional assistance before using an adapter or extension cord. These devices could interrupt the grounding circuit.
- Make sure that your power supply is set to the correct voltage in your area. If you are not sure about the voltage of the electrical outlet you are using, contact your local power company.
- If the power supply is broken, do not try to fix it by yourself. Contact a qualified service technician or your retailer.

Operation safety

- Before installing the motherboard and adding devices on it, carefully read all the manuals that came with the package.
- Before using the product, make sure all cables are correctly connected and the power cables are not damaged. If you detect any damage, contact your dealer immediately.
- To avoid short circuits, keep paper clips, screws, and staples away from connectors, slots, sockets and circuitry.
- Avoid dust, humidity, and temperature extremes. Do not place the product in any area where it may become wet.
- Place the product on a stable surface.
- If you encounter technical problems with the product, contact a qualified service technician or your retailer.



The symbol of the crossed out wheeled bin indicates that the product (electrical and electronic equipment) should not be placed in municipal waste. Please check local regulations for disposal of electronic products.

About this guide

This user guide contains the information you need when installing and configuring the motherboard.

How this guide is organized

This guide contains the following parts:

- **Chapter 1: Product introduction**
This chapter describes the features of the motherboard and the new technology it supports.
- **Chapter 2: BIOS setup**
This chapter tells how to change system settings through the BIOS Setup menus. Detailed descriptions of the BIOS parameters are also provided.
- **Chapter 3: Software support**
This chapter describes the contents of the support CD that comes with the motherboard package.

Where to find more information

Refer to the following sources for additional information and for product and software updates.

1. **ASUS websites**
The ASUS website provides updated information on ASUS hardware and software products. Refer to the ASUS contact information.
2. **Optional documentation**
Your product package may include optional documentation, such as warranty flyers, that may have been added by your dealer. These documents are not part of the standard package.

Conventions used in this guide

To make sure that you perform certain tasks properly, take note of the following symbols used throughout this manual.



DANGER/WARNING: Information to prevent injury to yourself when trying to complete a task.



CAUTION: Information to prevent damage to the components when trying to complete a task.



IMPORTANT: Instructions that you **MUST** follow to complete a task.



NOTE: Tips and additional information to help you complete a task.

Typography

Bold text

Indicates a menu or an item to select.

Italics

Used to emphasize a word or a phrase.

<Key>

Keys enclosed in the less-than and greater-than sign means that you must press the enclosed key.

Example: <Enter> means that you must press the Enter or Return key.

<Key1>+<Key2>+<Key3>

If you must press two or more keys simultaneously, the key names are linked with a plus sign (+).

Example: <Ctrl>+<Alt>+<D>

Command

Means that you must type the command exactly as shown, then supply the required item or value enclosed in brackets.

Example: At the DOS prompt, type the command line:

awdf`flash` P5NSLI.BIN

P5NSLI and P5NSLI/WiFi specifications summary

CPU	LGA775 socket for Intel® Core™ 2/Intel® Pentium D/ Intel® Pentium® 4/Intel® Celeron® processors Compatible with Intel® PCG 05B/05A/06B processors Supports Intel® Enhanced Memory 64 Technology (EM64T) Supports Enhanced Intel SpeedStep® Technology (EIST) Supports Intel® Hyper-Threading Technology
Chipset	North Bridge: NVIDIA® C19 SLI South Bridge: NVIDIA® MCP 51
Front Side Bus	1066/800/533 MHz
Memory	Dual-channel memory architecture 4 x 240-pin DIMM sockets support unbuffered non-ECC DDR2-667/DDR2-533 memory modules Supports up to 16 GB system memory
Expansion slots	2 x PCI Express x16 slots with Scalable Link Interface (SLI™) support 3 x PCI Express x1 slots 2 x PCI slots
Scalable Link Interface (SLI™)	SLI™ mode supports: - 2 x identical SLI™-ready PCI Express x16 graphics cards <i>(Note: In SLI mode, the PCI Express x16 slots work at the bandwidth of PCI Express x8. The combined bandwidth of these maintain the bandwidth of PCI Express x16.)</i> Single card mode supports (default): - 1 x PCI Express x16 graphics card on the first slot (blue) - 1 x PCI Express x1 card on the second slot (black) ASUS EZ Selector ASUS Two-slot thermal design
AI Audio	ADI® AD1986A SouldMAX 6-channel CODEC 1 x Coaxial S/PDIF out port Supports Audio Sensing and Enumeration Technology
Storage	NVIDIA® MCP 51 chipset supports: - 2 x Ultra DMA 133/100/66/33 - 4 x Serial ATA 3Gb/s devices - RAID 0, RAID 1, RAID 0+1, RAID 5 and JBOD configuration
Gigabit LAN	Marvell 88E8001 PCI Gigabit LAN controller Supports AI NET2 network diagnosis before entering OS
USB	Supports up to 8 USB 2.0 ports (P5NSLI model only) Supports up to 7 USB 2.0 ports (P5NSLI/WiFi model only)

(continued on the next page)

P5NSLI and P5NSLI/WiFi specifications summary

Overclocking features	Intelligent overclocking tool: <ul style="list-style-type: none"> - ASUS AI Overclocking (Intelligent CPU Frequency Tuner) Precision Tweaker supports: <ul style="list-style-type: none"> - vDIMM voltage: 4-step DRAM voltage control - vCore voltage: Adjustable CPU voltage at 0.0125 V Stepless Frequency Selection (SFS): <ul style="list-style-type: none"> - FSB tuning from 133MHz to 400 MHz at 1MHz increment; - memory tuning from 533 MHz to 1200MHz at 1MHz increment; - PCI-E tuning from 100 to 150MHz at 1 MHz increment Overclocking Protection: <ul style="list-style-type: none"> - ASUS C.P.R. (CPU Parameter Recall)
Special features	ASUS Q-Fan ASUS Q-Connector ASUS Fanless Design ASUS CrashFree BIOS 2 ASUS MyLogo2 ASUS EZ Flash 2 ASUS O.C. Profile ASUS Music Alarm
BIOS features	4 MB Flash ROM, Award BIOS, PnP, DMI2.0, SM BIOS 2.3, WfM2.0, ASUS EZ Flash 2, ASUS CrashFree BIOS2
Power Requirement	ATX power supply (with 24-pin and 4-pin 12V plugs) ATX 12V 2.0 compliant
Rear panel	1 x Parallel port 1 x Serial port 1 x LAN (RJ-45) ports USB 2.0 ports (5 ports on P5NSLI/WiFi; 4 ports on P5NSLI) 1 x Coaxial S/PDIF Out port 1 x Wireless LAN antenna activity LED (P5NSLI/WiFi model only) 1 x Wireless LAN antenna port (P5NSLI/WiFi model only) 1 x PS/2 keyboard port (purple) 1 x PS/2 mouse port (green) 6-channel audio ports

(continued on the next page)

P5NSLI and P5NSLI/WiFi specifications summary

Internal connectors	1 x Floppy disk drive connector 2 x IDE connectors 4 x Serial ATA connectors 1 x 24-pin ATX power connector 1 x 4-pin ATX 12 V power connector 2 x USB connectors for additional four USB 2.0 ports (1 USB connector on WiFi model) 1 x S/PDIF connector 2 x Internal audio connectors (CD, AUX) 1 x Chassis intrusion connector 1 x Front panel audio connector 1 x SLI selector card connector CPU, Chassis, Power fan connectors System panel connector
Manageability	WfM 2.0, DMI 2.0, WOL by PME, WOR by PME, PXE, RPL
Support CD contents	Device drivers ASUS PC Probe II ASUS Update NV RIS (Remote Installation Service) NV RAID Microsoft® DirectX 9.0c Anti-Virus Utility (OEM version) Adobe Acrobat Reader v7.0 ASUS Music Alarm
Form Factor	ATX form factor: 12 in x 9 in (30.5 cm x 22.9 cm)

* The USB8 is used for WiFi modular in P5NSLI/WiFi model.

* Specifications are subject to change without notice.

This chapter describes the motherboard features and the new technologies it supports.

1 Product introduction

1.1 Welcome!

Thank you for buying an ASUS® P5NSLI or ASUS® P5NSLI/WiFi motherboard!

The motherboard delivers a host of new features and latest technologies, making it another standout in the long line of ASUS quality motherboards!

Before you start installing the motherboard, and hardware devices on it, check the items in your package with the list below.

1.2 Package contents

Check your motherboard package for the following items.

Motherboard		P5NSLI WiFi	P5NSLI
Cables	Serial ATA and power cables for 2 devices	✓	✓
	1 x Ultra DMA 133/100/66 cables	✓	✓
	40-conductor IDE cable	✓	✓
	Floppy disk drive cable	✓	✓
Accessories	I/O shield	✓	✓
	Wireless LAN antenna	✓	-
	1 x EZ Selector card	✓	✓
	1 x SLI soft bridge	✓	✓
	1 X 2-port USB module	✓	✓
Application CD	ASUS motherboard support CD	✓	✓
Documentation	User guide	✓	✓



If any of the above items is damaged or missing, contact your retailer.

1.3 Special features

1.3.1 Product highlights

LGA775 Intel® Core™2 Processor Ready



This motherboard supports the latest Intel® Core™2 processor in the LGA775 package. With the new Intel® Core™ microarchitecture technology and 1066 / 800 / 533 MHz FSB, Intel® Core™2 processor is one of the most powerful and energy efficient CPU in the world.

NVIDIA® nForce™ 570 SLI™ Intel® Edition



Get the power of NVIDIA® nForce™ 570 SLI™ for Intel® platforms! High performance NVIDIA® nForce™ 570 SLI™ MCPs provide features designed with the gamer in mind. It delivers comprehensive features for advanced PC security, reliable PC storage, SLI™ technology, PCI Express bus architecture and dual DDR2 memory technology. NVIDIA® nForce™ 570 SLI™ offers Intel® enthusiasts stable, reliable, compatible platform support for ultimate PC performance.

Intel® Dual-Core Technology CPU support



The motherboard supports dual-core processors containing two physical CPU cores with dedicated L2 caches to meet demands for more powerful processing.

Intel® EM64T



The motherboard supports Intel® processors with the Intel® EM64T (Extended Memory 64 Technology). The Intel® EM64T feature allows your computer to run on 64-bit operating systems and access larger amounts of system memory for faster and more efficient computing.

Enhanced Intel SpeedStep® Technology (EIST)

The Enhanced Intel SpeedStep® Technology (EIST) intelligently manages the CPU resources by automatically adjusting the CPU voltage and core frequency depending on the CPU loading and system speed or power requirement.



Gigabit LAN

The Marvell Gigabit LAN controller delivers transfer speeds up to ten times faster than conventional 10/100 Ethernet connections. Gigabit LAN is the networking standard for the early future and is ideal for handling large amounts of data such as video, audio, and voice.

DDR2 memory support

The motherboard supports DDR2 memory which features data transfer rates of 667 MHz or 533 MHz to meet the higher bandwidth requirements of the latest 3D graphics, multimedia, and Internet applications. The dual-channel DDR2 architecture doubles the bandwidth of your system memory to boost system performance, eliminating bottlenecks with peak bandwidths of up to 10.7 GB/s. See pages 1-17 to 1-20 for details.

Serial ATA 3.0 Gb/s technology and SATA on the go

This motherboard supports the next-generation hard drives based on the Serial ATA (SATA) 3Gb/s storage specification, delivering enhanced scalability and doubling the bus bandwidth for high-speed data retrieval and saves. See pages 1-30, and 2-19 for details.

PCI Express™ interface

The motherboard fully supports PCI Express, the latest I/O interconnect technology that speeds up the PCI bus. PCI Express features point-to-point serial interconnections between devices and allows higher clockspeeds by carrying data in packets. This high speed interface is software compatible with existing PCI specifications. See pages 1-23 and 1-24 for details.

High Definition Audio

The onboard 6-channel High Definition audio CODEC enables high-quality ADI AD1986A audio CODEC, which automatically detects and identifies what types of peripherals are plugged into the audio I/O jacks and notifies users of inappropriate connection. See page 1-27 for details.

S/PDIF digital sound ready

The motherboard supports the S/PDIF technology through the S/PDIF interfaces on the rear panel and at midboard. The S/PDIF technology turns your computer into a high-end entertainment system with digital connectivity to powerful audio and speaker systems. See page 1-28 for details.

USB 2.0 technology

The motherboard implements the Universal Serial Bus (USB) 2.0 specification, dramatically increasing the connection speed from the 12 Mbps bandwidth on USB 1.1 to a fast 480 Mbps on USB 2.0. USB 2.0 is backward compatible with USB 1.1. See pages 1-24 and 1-31 for details.

1.3.2 Innovative ASUS features

Precision Tweaker



This feature allows you to fine tune the CPU/memory voltage and gradually increase the memory Front Side Bus (FSB) and PCI Express frequency at 1MHz increment to achieve maximum system performance.

AI NET 2



AI NET 2 is a BIOS-based diagnostic tool that detects and reports Ethernet cable faults and shorts. With this utility, you can easily monitor the condition of the Ethernet cable(s) connected to the Marvell LAN (RJ-45) port. During the bootup process, AI NET 2 immediately diagnoses the LAN cable and reports shorts and faults up to 100 meters at 1 meter accuracy. See pages 2-26 for details.

Fanless Design



Cooling fans, though a popular thermal solution, also come with noise and malfunction likelihood. ASUS Motherboard's fanless concept is specifically created to provide a cool environment without all the baggage.

ASUS has devoted special efforts to address the thermal issues across the motherboard, and most notably the areas that reside the CPU, power, VGA, Northbridge and Southbridge. The heat sinks and strategic board layout were tailor made to dissipate heat in the most efficient manner.

ASUS Two-slot thermal design

The motherboard is designed with two PCI Express x1 slots placed between the PCI Express x16 slots allowing an increase in airflow between the two PCI Express x16 graphics cards. This special design permits more room for ventilation thus lowering the overall system temperature.

CrashFree BIOS 2



This feature allows you to restore the original BIOS data from the support CD in case when the BIOS codes and data are corrupted. This protection eliminates the need to buy a replacement ROM chip. See page 2-6 for details.

ASUS MyLogo2™

This new feature present in the motherboard allows you to personalize and add style to your system with customizable boot logos. See page 2-42 for details.

ASUS EZ Flash 2

EZ Flash 2 is a user-friendly BIOS update utility. Simply press the predefined hotkey to launch the utility and update the BIOS without entering the OS. Update your BIOS easily without preparing a bootable diskette or using an OS-based flash utility. See page 2-8 and 2-49 for details.

C.P.R. (CPU Parameter Recall)

The C.P.R. feature of the motherboard BIOS allows automatic re-setting to the BIOS default settings in case the system hangs due to overclocking. When the system hangs due to overclocking, C.P.R. eliminates the need to open the system chassis and clear the RTC data. Simply shut down and reboot the system, and the BIOS automatically restores the CPU default setting for each parameter.

ASUS Q-Connector

ASUS Q-Connector allows you to easily connect or disconnect the chassis front panel cables to the motherboard. This unique module eliminates the trouble of connecting the system panel cables one at a time and avoiding wrong cable connections. See page 1-36 for details.

ASUS O.C. Profile

The motherboard features the ASUS O.C. Profile that allows users to conveniently store or load multiple BIOS settings. The BIOS settings can be stored in the CMOS or a separate file, giving users freedom to share and distribute their favorite settings. See page 2-47 and 2-48 for details.

ASUS Music Alarm

Wake up to the music of your choice instead of the irritating sound of an alarm clock. The ASUS Music Alarm gives you a personal wake-up call with your favorite CD music when system is off. See page 3-8 to 3-10 for details.

1.4 Before you proceed

Take note of the following precautions before you install motherboard components or change any motherboard settings.



- Unplug the power cord from the wall socket before touching any component.
- Use a grounded wrist strap or touch a safely grounded object or to a metal object, such as the power supply case, before handling components to avoid damaging them due to static electricity.
- Hold components by the edges to avoid touching the ICs on them.
- Whenever you uninstall any component, place it on a grounded antistatic pad or in the bag that came with the component.
- Before you install or remove any component, ensure that the ATX power supply is switched off or the power cord is detached from the power supply. Failure to do so may cause severe damage to the motherboard, peripherals, and/or components.

Onboard LED

The motherboard comes with a standby power LED. The green LED lights up to indicate that the system is ON, in sleep mode, or in soft-off mode. This is a reminder that you should shut down the system and unplug the power cable before removing or plugging in any motherboard component. The illustration below shows the location of the onboard LED.

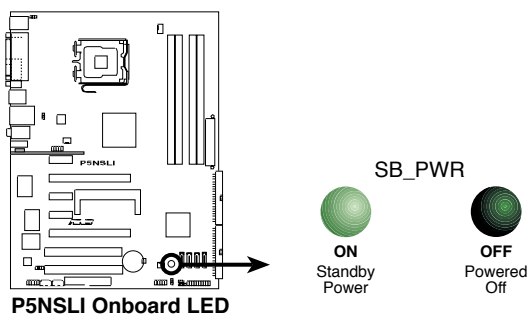

1.5 Motherboard overview

Before you install the motherboard, study the configuration of your chassis to ensure that the motherboard fits into it.



Make sure to unplug the power cord before installing or removing the motherboard. Failure to do so can cause you physical injury and damage motherboard components.

1.5.1 Placement direction

When installing the motherboard, make sure that you place it into the chassis in the correct orientation. The edge with external ports goes to the rear part of the chassis as indicated in the image below.

1.5.2 Screw holes

Place six (6) screws into the holes indicated by circles to secure the motherboard to the chassis.



Do not overtighten the screws! Doing so can damage the motherboard.

Place this side towards
the rear of the chassis

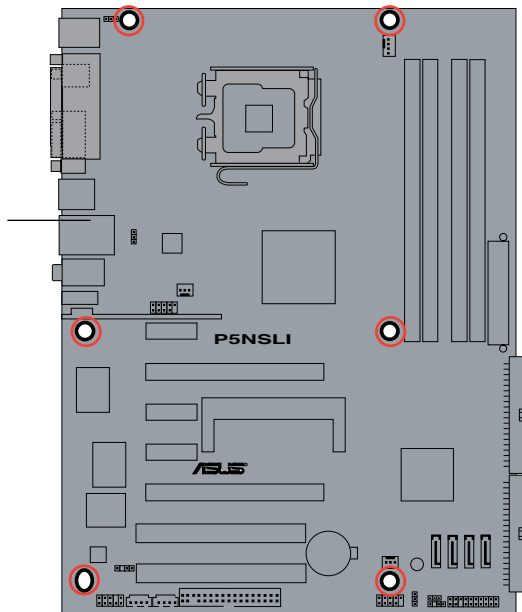

1.5.3 Motherboard layout

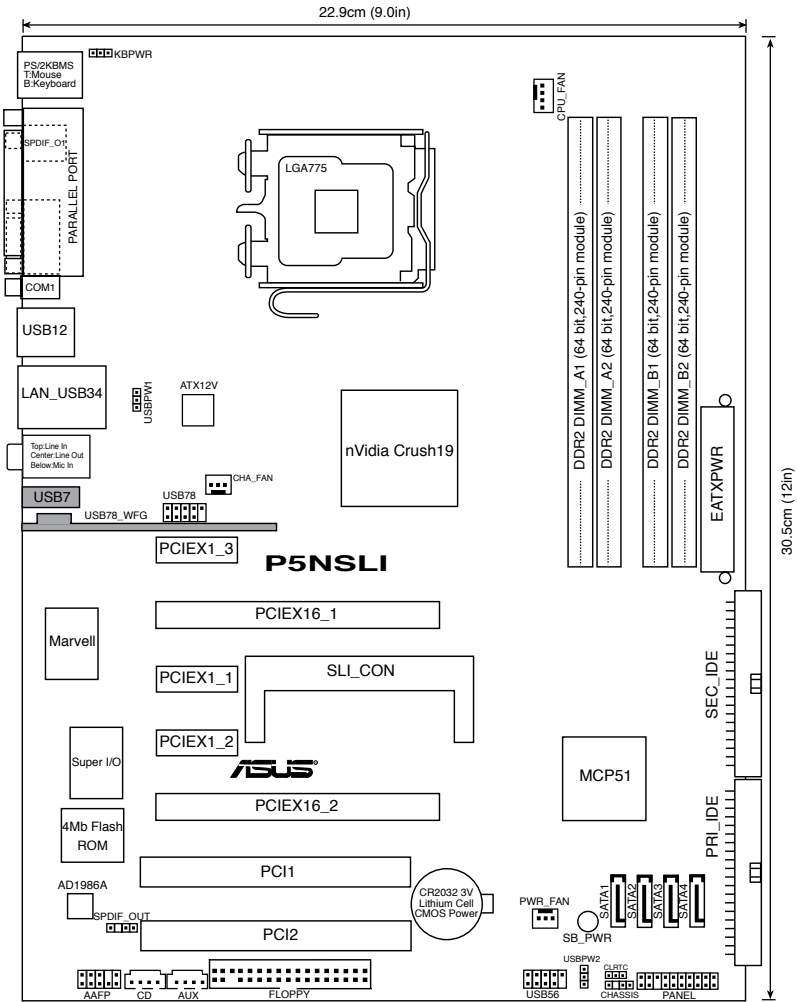

The USB78_WFG module and USB7 port are available to P5NSLI/WiFi model only. These items are greyed out in the given motherboard layout.

1.6 Central Processing Unit (CPU)

The motherboard comes with a surface mount LGA775 socket designed for the Intel® Core™2, Intel® Pentium® D, Intel® Pentium® 4 and Intel® Celeron® processors in the 775-land package.



- Install a chassis fan with at least a speed of 2400 rpm and 8 CFM turnrate when using a dual-core CPU to ensure system stability. Overheating can permanently damage the system and/or CPU.
- Upon purchase of the motherboard, make sure that the PnP cap is on the socket and the socket contacts are not bent. Contact your retailer immediately if the PnP cap is missing, or if you see any damage to the PnP cap/socket contacts/motherboard components. ASUS will shoulder the cost of repair only if the damage is shipment/transit-related.
- Keep the cap after installing the motherboard. ASUS will process Return Merchandise Authorization (RMA) requests only if the motherboard comes with the cap on the LGA775 socket.
- The product warranty does not cover damage to the socket contacts resulting from incorrect CPU installation/removal, or misplacement/loss/incorrect removal of the PnP cap.

1.6.1 Installing the CPU

To install a CPU:

1. Locate the CPU socket on the motherboard.

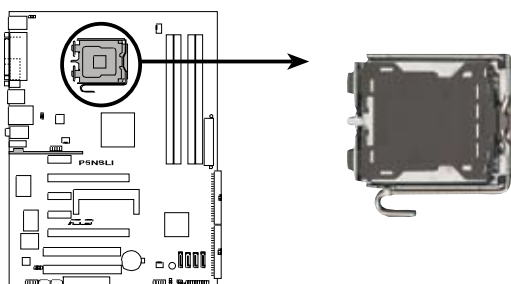

P5NSLI CPU Socket 775



Before installing the CPU, make sure that the cam box is facing towards you and the load lever is on your left.

2. Press the load lever with your thumb (A), then move it to the left (B) until it is released from the retention tab.

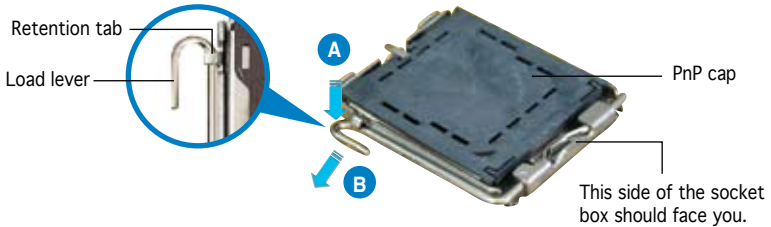

To prevent damage to the socket pins, do not remove the PnP cap unless you are installing a CPU.

3. Lift the load lever in the direction of the arrow to a 135° angle.

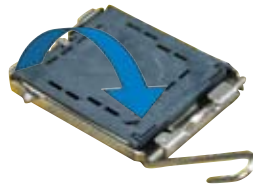

4. Lift the load plate with your thumb and forefinger to a 100° angle (A), then push the PnP cap from the load plate window to remove (B).

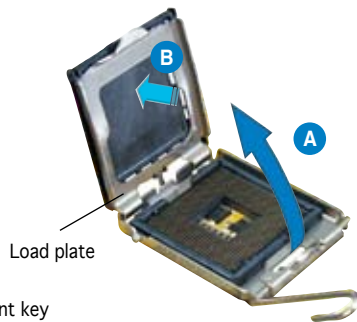

5. Position the CPU over the socket, making sure that the gold triangle is on the bottom-left corner of the socket. The socket alignment key should fit into the CPU notch.

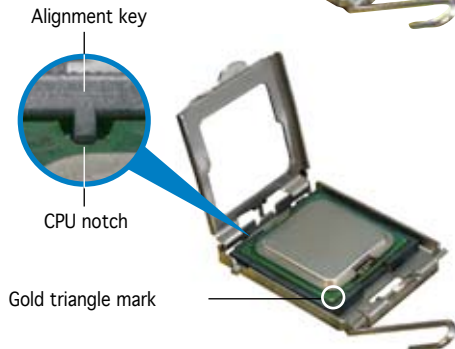



The CPU fits in only one correct orientation. DO NOT force the CPU into the socket to prevent bending the connectors on the socket and damaging the CPU!

6. Close the load plate (A), then push the load lever (B) until it snaps into the retention tab.



The motherboard supports Intel® Pentium® 4 LGA775 processors with the Intel® Enhanced Memory 64 Technology (EM64T), Enhanced Intel SpeedStep® Technology (EIST), and Hyper-Threading Technology.

1.6.2 Installing the CPU heatsink and fan

Intel® LGA775 processors require a specially designed heatsink and fan assembly to ensure optimum thermal condition and performance.



- When you buy a boxed Intel® processor, the package includes the CPU fan and heatsink assembly. **If you buy a CPU separately, make sure that you use only Intel®-certified multi-directional heatsink and fan.**
- Your Intel® LGA775 processor heatsink and fan assembly comes in a push-pin design and requires no tool to install.
- If you purchased a separate CPU heatsink and fan assembly, make sure that you have properly applied Thermal Interface Material to the CPU heatsink or CPU before you install the heatsink and fan assembly.



Make sure that you have installed the motherboard to the chassis before you install the CPU fan and heatsink assembly.

To install the CPU heatsink and fan:

1. Place the heatsink on top of the installed CPU, making sure that the four fasteners match the holes on the motherboard.



Orient the heatsink and fan assembly such that the CPU fan cable is closest to the CPU fan connector.

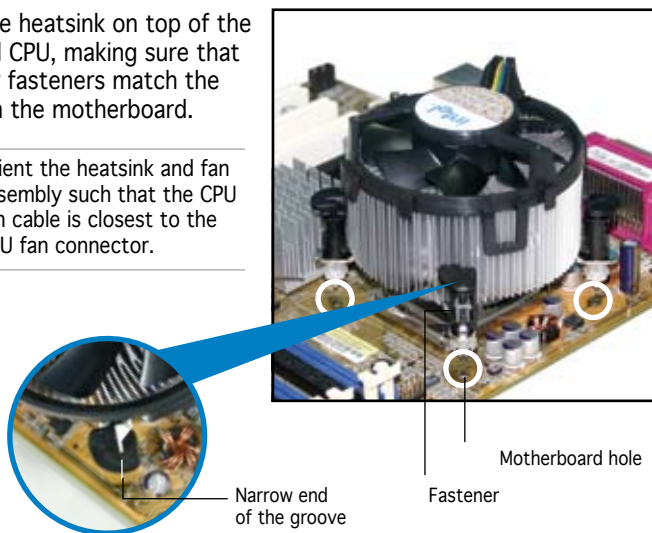

Make sure to orient each fastener with the narrow end of the groove pointing outward. (The photo shows the groove shaded for emphasis.)

2. Push down two fasteners at a time in a diagonal sequence to secure the heatsink and fan assembly in place.

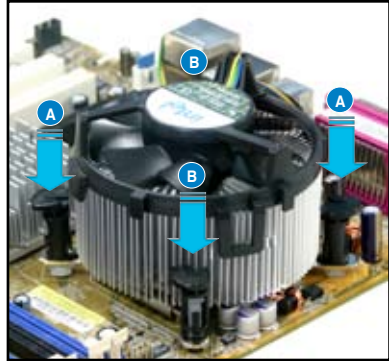
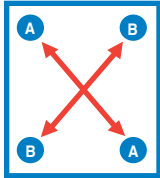

3. Connect the CPU fan cable to the connector on the motherboard labeled CPU_FAN.

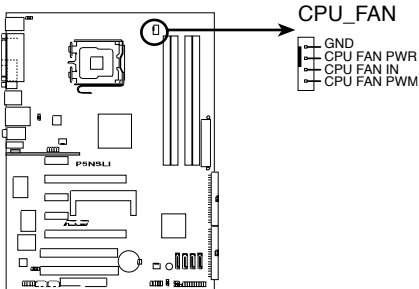

P5NSLI CPU Fan Connectors



- Do not forget to connect the CPU fan connector! Hardware monitoring errors can occur if you fail to plug this connector.
- The retention module of some third-party CPU heatsink and fan can interfere with chipset components at the bottom of the board. Before purchasing a separate CPU heatsink and fan, make sure that it will not interfere with the chipset components.

1.6.3 Uninstalling the CPU heatsink and fan

To uninstall the CPU heatsink and fan:

1. Disconnect the CPU fan cable from the connector on the motherboard.
2. Rotate each fastener counterclockwise.

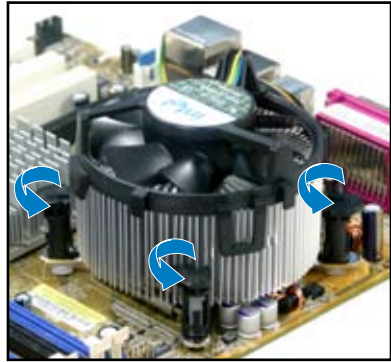

3. Pull up two fasteners at a time in a diagonal sequence to disengage the heatsink and fan assembly from the motherboard.

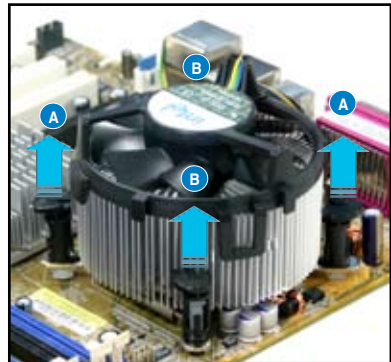
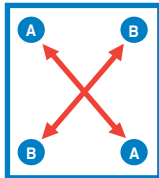

4. Carefully remove the heatsink and fan assembly from the motherboard.



5. Rotate each fastener clockwise to ensure correct orientation when reinstalling.

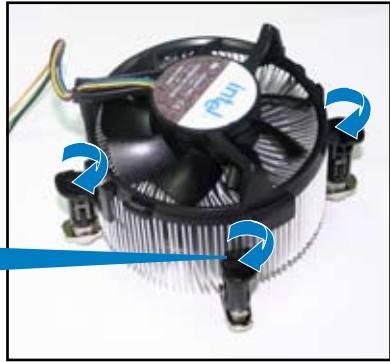

Narrow end of the groove



The narrow end of the groove should point outward after resetting. (The photo shows the groove shaded for emphasis.)



Refer to the documentation in the boxed or stand-alone CPU fan package for detailed information on CPU fan installation.

1.7 System memory

1.7.1 Overview

The motherboard comes with four Double Data Rate 2 (DDR2) Dual Inline Memory Modules (DIMM) sockets.

A DDR2 module has the same physical dimensions as a DDR DIMM but has a 240-pin footprint compared to the 184-pin DDR DIMM. DDR2 DIMMs are notched differently to prevent installation on a DDR DIMM socket.

The figure illustrates the location of the DDR2 DIMM sockets:

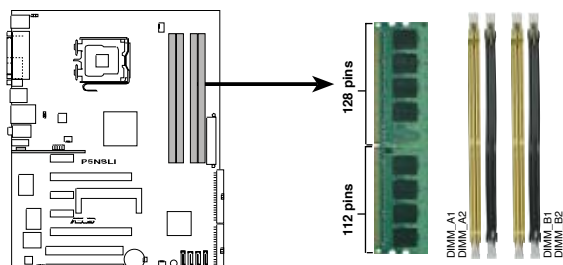

P5NSLI 240-pin DDR2 DIMM Sockets

Channel	Sockets
Channel A	DIMM_A1 and DIMM_A2
Channel B	DIMM_B1 and DIMM_B2

1.7.2 Memory configurations

You may install 256 MB, 512 MB, 1 GB and 2 GB unbuffered non-ECC DDR2 DIMMs into the DIMM sockets.



- For dual-channel configuration, the total size of memory module(s) installed per channel must be the same (DIMM_A1 + DIMM_A2 = DIMM_B1 + DIMM_B2).
- Always install DIMMs with the same CAS latency. For optimum compatibility, it is recommended that you obtain memory modules from the same vendor. Refer to the DDR2 Qualified Vendors List on the next page for details.
- Due to chipset resource allocation, the system may detect less than 8 GB system memory when you installed four 2 GB DDR2 memory modules.
- If you install four 1 GB memory modules, the system may only recognize less than 3 GB because the address space is reserved for other critical functions. This limitation appears on Windows® XP 32-bit operation system which does not support Physical Address Extension (PAE).
- If you install Windows® XP 32-bit operation system, a total memory of less than 3GB is recommended.



Notes on memory limitations

The motherboard can support up to 16 GB on the operating systems listed below. You may install a maximum of 2 GB DIMMs on each slot, but only DDR2-533 2 GB density modules are available for this configuration.

32-bit	64-bit
Windows® 2000 Advanced Server Windows® Server 2003 Enterprise Edition	Windows® Server 2003 Standard x64 Edition Windows® XP Professional x64 Edition Windows® Server 2003 Enterprise x64 Edition

Qualified Vendors Lists (QVL)

DDR2 with 667 MHz capability

Size	Vendor	Chip No.	Brand	Side(s)	Part No.	DIMM support		
						A	B	C
512MB	Kingston	E5108AE-GE-E	N/A	SS	KVR667D2N5/512	•	•	•
1024MB	Kingston	E5108AE-GE-E	N/A	DS	KVR667D2N5/1G	•	•	
512MB	Kingston	E5108AE-6E-E	N/A	SS	KVR667D2N5/512	•	•	•
1024MB	Kingston	E5108AE-6E-E	N/A	DS	KVR667D2N5/1G	•	•	
512MB	Kingston	E5108AE-6E-E	N/A	SS	KVR667D2E5/512	•	•	•
256MB	Samsung	K4T56083QF-ZCE6	N/A	SS	M378T3253FZ0-CE6	•	•	•
512MB	Samsung	K4T56083QF-ZCE6	N/A	DS	M378T6453FZ0-CE6	•	•	•
256MB	Samsung	K4T51163QC-ZCE6	N/A	SS	M378T3354CZ0-CE6	•	•	•
512MB	Samsung	ZCE6K4T51083QC	N/A	SS	M378T6553CZ0-CE6	•	•	•
1024MB	Samsung	ZCE6K4T51083QC	N/A	DS	M378T2953CZ0-CE6	•	•	
512MB	MICRON	4VB41D9CZM	N/A	DS	MT16HTF6464AY-667B4	•	•	•
256MB	MICRON	5FB42D9DPN	N/A	SS	MT8HTF3264AY-667B6	•	•	•
256MB	Infineon	HYB18T512160AF-3S	N/A	SS	HYS64T3200HU-3S-A	•	•	•
512MB	Infineon	HYB18T512800AF3S	N/A	SS	HYS64T6400HU-3S-A	•	•	•
1024MB	Infineon	HYB18T512800AF3S	N/A	DS	HYS64T128020HU-3S-A	•	•	
512MB	Hynix	HY5PS12821AFP-Y5	N/A	SS	HYMP564U64AP8-Y5	•	•	
1024MB	Hynix	HY5PS12821AFP-Y5	N/A	DS	HYMP512U64AP8-Y5	•	•	
512MB	Hynix	HY5PS12821AFP-Y4	N/A	SS	HYMP564U64AP8-Y4	•	•	•
1024MB	Hynix	HY5PS12821AFP-Y4	N/A	DS	HYMP512U64AP8-Y4	•	•	
256MB	ELPIDA	E2508AB-GE-E	N/A	SS	EBE25UC8ABFA-6E-E	•	•	•
512MB	ELPIDA	E5108AE-GE-E	N/A	SS	EBE51UD8AEFA-6E-E	•	•	•
512MB	crucial	Heat-Sink Package	N/A	DS	BL6464AA664.16FB	•	•	•
1024MB	crucial	Heat-Sink Package	N/A	DS	BL12864AA664.16FA	•	•	
512MB	crucial	Heat-Sink Package	N/A	DS	BL6464AL664.16FB	•	•	
512MB	TwinMOS	E5108AE-GE-E	N/A	SS	8G-25JK5-EBT	•	•	
512MB	KINGMAX	E5108AE-6E-E	N/A	SS	KLCC28F-A8EB5	•	•	•
1024MB	KINGMAX	E5108AE-6E-E	N/A	DS	KLCD48F-A8EB5	•	•	•
512MB	GEIL	Heat-Sink Package	N/A	SS	GX21GB5300UDC	•	•	•
512MB	GEIL	Heat-Sink Package	N/A	SS	GX21GB5300DC	•	•	
256MB	NANYA	NT5TU32M16AG-3C	N/A	SS	NT256T64UH4A0FY-3C	•	•	•
512MB	NANYA	NT5TU64M8AE-3C	N/A	SS	NT512T64U88A0BY-3C	•	•	•
512MB	WINTEC	4UAI2D9CRZ	N/A	SS	39127282	•	•	•
1024MB	WINTEC	4WAIID9CWX	N/A	DS	39137282	•	•	
512MB	Apacer	E5108AE-6E-E	N/A	SS	78.91092.420	•	•	•
1024MB	Apacer	E5108AE-6E-E	N/A	DS	78.01092.420	•	•	
512MB	A-DATA	E5108AE-6E-E	N/A	SS	M20EL5G3H3160B1COZ	•	•	•
512MB	MDT	18D51280D-30S18	N/A	SS	M512-667-8	•	•	
1024MB	MDT	18D51280D-30S28	N/A	DS	M924-667-16	•	•	

DDR2-533

Size	Vendor	Chip No.	Brand	Side(s)	Part No.	DIMM support		
						A	B	C
256MB	Kingston	E5116AB-5C-E	N/A	SS	KVR533D2N4/256	•	•	•
512MB	Kingston	HY5PS56821F-C4	N/A	DS	KVR533D2N4/512	•	•	•
1024MB	Kingston	D6408TE7BL-37	N/A	DS	KVR533D2N4/1G	•	•	
512MB	Samsung	K4T51083QB-GCD5	N/A	SS	M378T6553BG0-CD5	•	•	•
256MB	Samsung	K4T56083QF-GCD5	N/A	SS	M378T3253FG0-CD5	•	•	•
512MB	Samsung	K4T56083QF-GCD5	N/A	DS	M378T6453FG0-CD5	•	•	•
512MB	MICRON	4FBII9BQM	N/A	DS	MT16HTF6464AG-53EB2	•	•	•
256MB	MICRON	4FBII9CHM	N/A	SS	MT8HTF3264AY-53EB3	•	•	•
512MB	MICRON	4FBII9CHM	N/A	DS	MT16HTF6464AY-53EB2	•	•	•
512MB	Infineon	HYB18T512800AC37	N/A	SS	HYS64T64000GU-3.7-A	•	•	•
256MB	Infineon	HYB18T5121608AF-3.7	N/A	SS	HYS64T32000HU-3.7-A	•	•	•
512MB	Infineon	HYB18T512800AF37	N/A	SS	HYS64T64000HU-3.7-A	•	•	•
256MB	Infineon	HYB18T512800AF37	N/A	DS	HYS64T128020HU-3.7-A	•	•	•
2048MB	Infineon	HYB18T1G800AF-3.7	N/A	DS	HYS64T256020HU-3.7-A	•	•	•
256MB	Infineon	HYB18T5121608BF-3.7	N/A	SS	HYS64T32000HU-3.7-B	•	•	•
512MB	Infineon	HYB18T512800BF37	N/A	SS	HYS64T64000HU-3.7-B	•	•	•
1024MB	Infineon	HYB18T512800BF37	N/A	DS	HYS64T128020HU-3.7-B	•	•	•
512MB	Hynix	HY5PS12821F-C4	N/A	SS	HYMP564U648-C4	•	•	•
1024MB	Hynix	HY5PS12821F-C4	N/A	DS	HYMP512U648-C4	•	•	•
512MB	Hynix	HY5PS12821AFP-C3	N/A	SS	HYMP564U64AP8-C3	•	•	•
1024MB	Hynix	HY5PS12821AFP-C3	N/A	DS	HYMP512U64AP8-C3	•	•	•
512MB	ELPIDA	E5108AB-5C-E	N/A	SS	EBE51UD8ABFA-5C	•	•	•
512MB	ELPIDA	E5108AB-5C-E	N/A	SS	EBE51UD8ABFA-5C-E	•	•	•
256MB	Apacer	E5116AB-5C-E	N/A	SS	78.81077.420	•	•	•
256MB	crucial	Heat-Sink Package	N/A	SS	BL3264AA53V.8FB	•	•	•
512MB	crucial	Heat-Sink Package	N/A	DS	BL6464AA53V.16FB	•	•	•
256MB	KINGMAX	K4T56083QF-GCD5	N/A	SS	KLBB68K-38SP4	•	•	•
1024MB	KINGMAX	E5108AB-5C-E	N/A	DS	KLBD48F-A8EP4	•	•	•
512MB	KINGMAX	E5108AB-5C-E	N/A	SS	KLBC28F-A8EP4	•	•	•
256MB	KINGMAX	KKEA88A4IA-37	N/A	SS	KLBB68F-38KP4	•	•	•
512MB	KINGMAX	KKEA88A4IA-37	N/A	SS	KLBC28F-A8KP4	•	•	•
256MB	KINGMAX	E5116AB-5C-E	N/A	SS	KLBB68F-36EP4	•	•	•
512MB	KINGMAX	E5108AE-5C-E	N/A	SS	KLBC28F-A8EB4	•	•	•
1024MB	KINGMAX	E5108AE-5C-E	N/A	DS	KLBD48F-A8EB4	•	•	•
512MB	Transcend	K4T51083QB-GCD5	N/A	SS	TS64MLQ64V5J	•	•	•
1024MB	Transcend	K4T51083QB-GCD5	N/A	DS	TS128MLQ64V5J	•	•	•



Visit the ASUS website (www.asus.com) for the latest QVL.

Side(s): SS - Single-sided DS - Double-sided

DIMM support:

- A - Supports one module inserted into either slot, in Single-channel memory configuration.
- B - Supports one pair of modules inserted into either the yellow slots or the black slots as one pair of Dual-channel memory configuration.
- C - Supports two pairs of modules inserted into the yellow and black slots as two pairs of Dual-channel memory configuration.

1.7.3 Installing a DIMM



Unplug the power supply before adding or removing DIMMs or other system components. Failure to do so can cause severe damage to both the motherboard and the components.

To install a DIMM:

1. Unlock a DIMM socket by pressing the retaining clips outward.
2. Align a DIMM on the socket such that the notch on the DIMM matches the break on the socket.
3. Firmly insert the DIMM into the socket until the retaining clips snap back in place and the DIMM is properly seated.

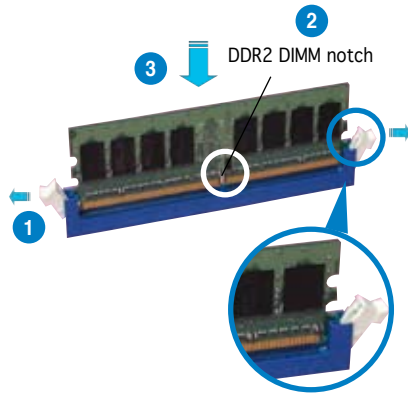

Unlocked retaining clip



- A DDR2 DIMM is keyed with a notch so that it fits in only one direction. Do not force a DIMM into a socket to avoid damaging the DIMM.
- The DDR2 DIMM sockets do not support DDR DIMMs. DO not install DDR DIMMs to the DDR2 DIMM sockets.

1.7.4 Removing a DIMM

Follow these steps to remove a DIMM.

1. Simultaneously press the retaining clips outward to unlock the DIMM.



Support the DIMM lightly with your fingers when pressing the retaining clips. The DIMM might get damaged when it flips out with extra force.

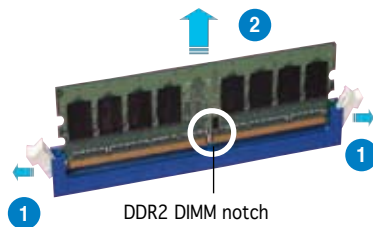

2. Remove the DIMM from the socket.

1.8 Expansion slots

In the future, you may need to install expansion cards. The following sub-sections describe the slots and the expansion cards that they support.



Make sure to unplug the power cord before adding or removing expansion cards. Failure to do so may cause you physical injury and damage motherboard components.

1.8.1 Installing an expansion card

To install an expansion card:

1. Before installing the expansion card, read the documentation that came with it and make the necessary hardware settings for the card.
2. Remove the system unit cover (if your motherboard is already installed in a chassis).
3. Remove the bracket opposite the slot that you intend to use. Keep the screw for later use.
4. Align the card connector with the slot and press firmly until the card is completely seated on the slot.
5. Secure the card to the chassis with the screw you removed earlier.
6. Replace the system cover.

1.8.2 Configuring an expansion card

After installing the expansion card, configure it by adjusting the software settings.

1. Turn on the system and change the necessary BIOS settings, if any. See Chapter 2 for information on BIOS setup.
2. Assign an IRQ to the card. Refer to the tables on the next page.
3. Install the software drivers for the expansion card.



When using PCI cards on shared slots, ensure that the drivers support “Share IRQ” or that the cards do not need IRQ assignments. Otherwise, conflicts will arise between the two PCI groups, making the system unstable and the card inoperable. Refer to the table on the next page for details.

1.8.3 Interrupt assignments

Standard interrupt assignments

IRQ	Priority	Standard Function
0	1	System Timer
1	2	Keyboard Controller
2	—	Re-direct to IRQ#9
4	12	Communications Port (COM1)*
5	13	IRQ holder for PCI steering*
6	14	Floppy Disk Controller
7	15	Printer Port (LPT1)*
8	3	System CMOS/Real Time Clock
9	4	IRQ holder for PCI steering*
10	5	IRQ holder for PCI steering*
11	6	IRQ holder for PCI steering*
12	7	PS/2 Compatible Mouse Port*
13	8	Numeric Data Processor
14	9	Primary IDE Channel
15	10	Secondary IDE Channel

* These IRQs are usually available for ISA or PCI devices.

IRQ assignments for this motherboard

	A	B	C	D	E	F	G	H
PCI Express x16 slot 1	—	—	—	—	shared	—	—	—
PCI Express x16 slot 2	—	—	—	—	—	—	used	—
PCI Express x1 slot 1	—	—	—	—	shared	—	—	—
PCI Express x1 slot 2	—	—	—	—	—	used	—	—
PCI Express x1 slot 3	—	—	—	—	—	—	—	used
PCI slot 1	shared	—	—	—	—	—	—	—
PCI slot 2	—	shared	—	—	—	—	—	—
Onboard USB1.0 controller 1	shared	—	—	—	—	—	—	—
Onboard USB1.0 controller 2	—	shared	—	—	—	—	—	—
Onboard USB2.0 controller	—	—	shared	—	—	—	—	—
Onboard LAN	—	—	shared	—	—	—	—	—
Onboard IDE controller	—	—	—	—	shared	—	—	—
Onboard SATA controller	shared	—	—	—	—	—	—	—
Onboard Audio controller	shared	—	—	—	—	—	—	—

1.8.4 PCI slots

The PCI slots support cards such as a LAN card, SCSI card, USB card, and other cards that comply with PCI specifications. The figure shows a LAN card installed on a PCI slot.

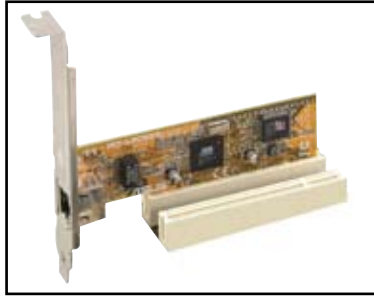

1.8.5 PCI Express x1 slot

This motherboard supports PCI Express x1 network cards, SCSI cards and other cards that comply with the PCI Express specifications. The figure shows a network card installed on the PCI Express x1 slot.

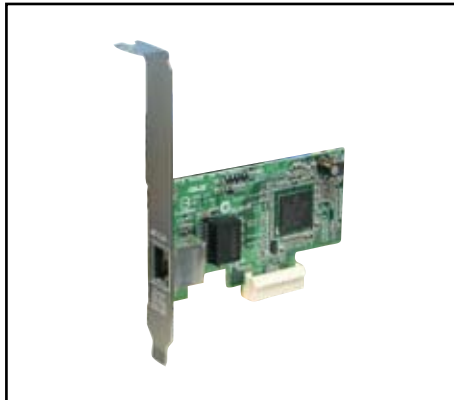

1.8.6 Two PCI Express x16 slots

This motherboard supports one PCI Express x16 graphics card or two SLI-ready PCI Express x16 graphic cards that comply with the PCI Express specifications. The figure shows a graphics card installed on the PCI Express x16 slot.



Install a rear chassis fan to the chassis (CHA_FAN) connector when using two graphics cards for better thermal environment. See page 1-32 for details.



- In Single Card mode, only the PCI Express blue slot can be used for PCI Express x16 graphics cards.
- In SLI mode, the PCI Express x16 slots work at the bandwidth of PCI Express x8. The combined bandwidth of these maintain the bandwidth of PCI Express x16.
- See the table below for possible PCI Express card configurations.

PCI Express x16 slot configurations

EZ Selector setting		PCIEX16_1 (blue) slot		PCIEX16_2 (black) slot	
		Card Type	Speed	Card Type	Speed
Single Video Card		Qualified PCIe x16 graphics card	x16	Qualified RAID or LAN card	x1
Dual Video Cards	SLI mode	Qualified SLI-ready graphics cards	x8	Qualified SLI-ready graphics card	x8
	Multi-monitor, RAID or LAN setup	Qualified PCIe x16 graphics card	x8	Qualified PCIe graphics card, RAID or LAN card	x8, x4, x2, x1

1.9 Jumpers

1. Clear RTC RAM (CLRRTC)

This jumper allows you to clear the Real Time Clock (RTC) RAM in CMOS. You can clear the CMOS memory of date, time, and system setup parameters by erasing the CMOS RTC RAM data. The onboard button cell battery powers the RAM data in CMOS, which include system setup information such as system passwords.

To erase the RTC RAM:

1. Turn OFF the computer and unplug the power cord.
2. Remove the onboard battery.
3. Move the jumper cap from pins 1-2 (default) to pins 2-3. Keep the cap on pins 2-3 for about 5~10 seconds, then move the cap back to pins 1-2.
4. Re-install the battery.
5. Plug the power cord and turn ON the computer.
6. Hold down the key during the boot process and enter BIOS setup to re-enter data.



Except when clearing the RTC RAM, never remove the cap on CLRRTC jumper default position. Removing the cap will cause system boot failure!

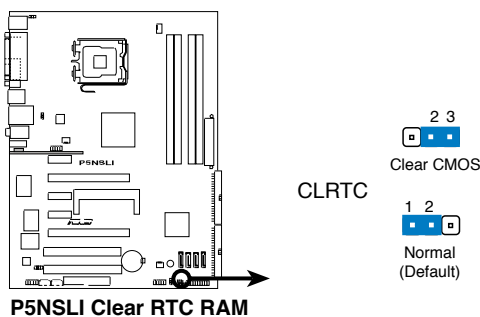

- Make sure to re-enter your previous BIOS settings after you clear the CMOS.
- You do not need to clear the RTC when the system hangs due to overclocking. For system failure due to overclocking, use the C.P.R. (CPU Parameter Recall) feature. Shut down and reboot the system so the BIOS can automatically reset parameter settings to default values.

2. USB device wake-up (3-pin USBPW1, USBPW2)

Set these jumpers to +5V to wake up the computer from S1 sleep mode (CPU stopped, DRAM refreshed, system running in low power mode) using the connected USB devices. Set to +5VSB to wake up from S3 and S4 sleep modes (no power to CPU, DRAM in slow refresh, power supply in reduced power mode).

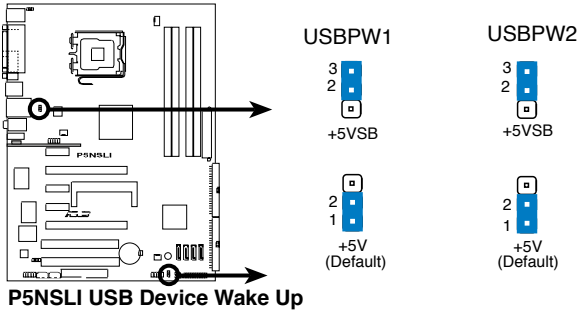

- The USB device wake-up feature requires a power supply that can provide 500mA on the +5VSB lead for each USB port; otherwise, the system would not power up.
- The total current consumed must NOT exceed the power supply capability (+5VSB) whether under normal condition or in sleep mode.

3. Keyboard power (3-pin KBPWR)

This jumper allows you to enable or disable the keyboard wake-up feature. Set this jumper to pins 2-3 (+5VSB) to wake up the computer when you press a key on the keyboard (the default is the Space Bar). This feature requires an ATX power supply that can supply at least 1A on the +5VSB lead, and a corresponding setting in the BIOS.

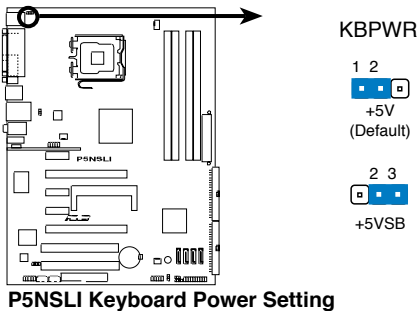

1.10 Connectors

1.10.1 Rear panel connectors

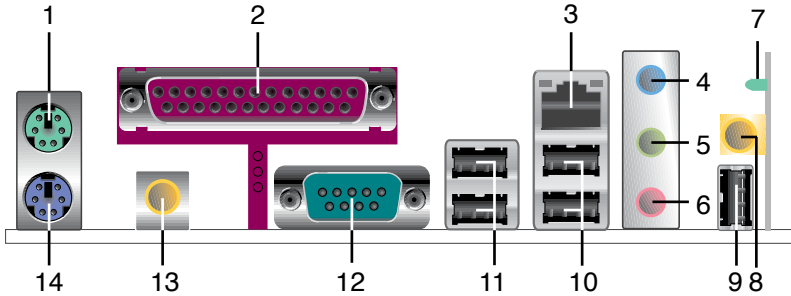

- 1. PS/2 mouse port (green).** This port is for a PS/2 mouse.
- 2. Parallel port.** This 25-pin port connects a parallel printer, a scanner, or other devices.
- 3. LAN (RJ-45) port.** Supported by Marvell® Gigabit LAN controller, this port allows Gigabit connection to a Local Area Network (LAN) through a network hub.



ACTIVITY/
LINK LED

SPEED
LED

LAN port

Activity/Link LED	Speed LED	Description
OFF	OFF	Soft-off Mode
Orange*	OFF	During Power ON/OFF or 10Mbps connection
Orange*	Orange	100Mbps connection
Orange*	Green	1Gbps connection

* Blinking

- 4. Line In port (light blue).** This port connects the tape, CD, DVD player, or other audio sources.
- 5. Line Out port (lime).** This port connects a headphone or a speaker. In 4-channel, and 6-channel configuration, the function of this port becomes Front Speaker Out.
- 6. Microphone port (pink).** This port connects a microphone.



Refer to the audio configuration table below for the function of the audio ports in 2, 4, or 6-channel configuration.

Audio 2, 4, or 6-channel configuration

Port	Headset 2-channel	4-channel	6-channel
Light Blue	Line In	Rear Speaker Out	Surround
Lime	Line Out	Front Speaker Out	Front Speaker Out
Pink	Mic In	Mic In	Center/Bass

7. **Wireless LAN activity LED** (P5NSLI/WiFi model only). The wireless LAN module comes with an activity LED. Refer to the table below for the LED indications.

Status	Description
ON	The wireless LAN module is on but has no data activity
OFF	The wireless LAN module is off
Flashing	The wireless LAN module is transmitting or receiving data or both. The wireless LAN module is scanning for available access point or another wireless device

8. **Wireless LAN antenna port** (P5NSLI/WiFi model only). This port connects to the optional dipolar antenna for the onboard WiFi-g™ wireless solution.
9. **USB 2.0 port 7** (P5NSLI/WiFi model only). This 4-pin Universal Serial Bus (USB) ports is available for connecting USB 2.0 devices.
10. **USB 2.0 ports 3 and 4**. These two 4-pin Universal Serial Bus (USB) ports are available for connecting USB 2.0 devices.
11. **USB 2.0 ports 1 and 2**. These two 4-pin Universal Serial Bus (USB) ports are available for connecting USB 2.0 devices.
12. **Serial port**. This port connects a mouse, modem, or other devices that conform with serial specification.
13. **Coaxial S/PDIF Out port**. This port connects an external audio output device via a coaxial S/PDIF cable.
14. **PS/2 keyboard port (purple)**. This port is for a PS/2 keyboard.

1.10.2 Internal connectors

1. Floppy disk drive connector (34-1 pin FLOPPY)

This connector is for the provided floppy disk drive (FDD) signal cable. Insert one end of the cable to this connector, then connect the other end to the signal connector at the back of the floppy disk drive.



Pin 5 on the connector is removed to prevent incorrect cable connection when using a FDD cable with a covered Pin 5.

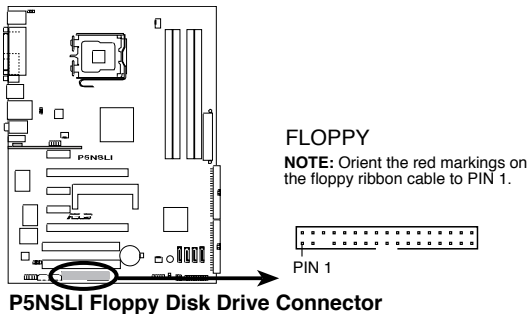

2. IDE connector (40-1 pin PRI_IDE)

The onboard IDE connector is for the Ultra DMA 133/100/66 signal cable. There are three connectors on each Ultra DMA 133/100/66 signal cable: blue, black, and gray. Connect the blue connector to the motherboard's IDE connector, then select one of the following modes to configure your device.

	Drive jumper setting	Mode of device(s)	Cable connector
Single device	Cable-Select or Master	-	Black
Two devices	Cable-Select	Master	Black
		Slave	Gray
	Master	Master	Black or gray
	Slave	Slave	



- Pin 20 on the IDE connector is removed to match the covered hole on the Ultra DMA cable connector. This prevents incorrect insertion when you connect the IDE cable.
- Use the 80-conductor IDE cable for Ultra DMA 133/100/66 IDE devices.



If any device jumper is set as "Cable-Select," make sure all other device jumpers have the same setting.

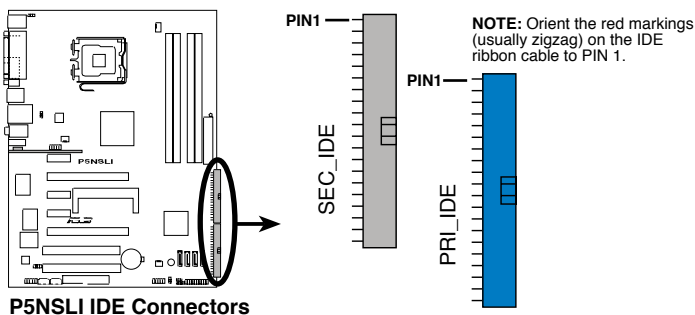

3. Serial ATA connectors (7-pin SATA1 [red], SATA2 [red], SATA3 [red], SATA4 [red])

These connectors are for the Serial ATA signal cables for Serial ATA hard disk and optical disk drives.



- These connectors are Disabled by default. If you intend to create a Serial ATA RAID set using these connectors, enable the First, Second, Third or Fourth SATA Master RAID items in **Advanced > Onboard Devices Configuration > NVRAID Configuration** of the BIOS. See section “2.4.6 Onboard Devices Configuration” on page 2-30 for details.

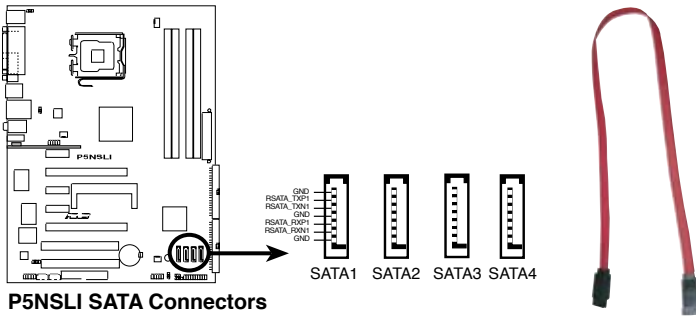

P5NSLI SATA Connectors



These connectors support Native Command Queuing (NCQ), Power Management (PM) Implementation Algorithm, Hot Swap and smart setup.

4. Audio connectors (4-pin CD, AUX)

These connectors allow you to receive stereo audio input from sound sources such as a CD-ROM, TV-tuner, or MPEG card.

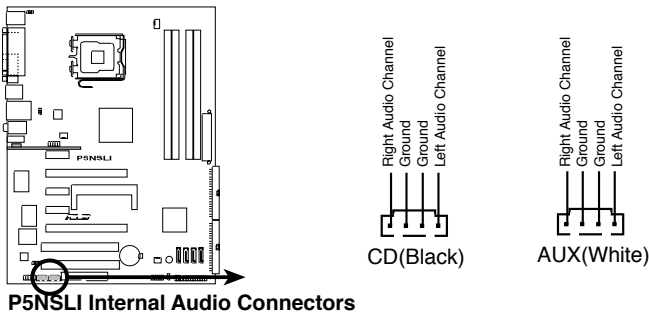

P5NSLI Internal Audio Connectors

5. USB connectors (10-1 pin USB56, USB78)

These connectors are for USB 2.0 ports. Connect the USB module cable to any of these connectors, then install the module to a slot opening at the back of the system chassis. These USB connectors comply with USB 2.0 specification that supports up to 480 Mbps connection speed.



On WiFi model, the onboard WiFi and the rear panel USB7 port use the USB78 connector.

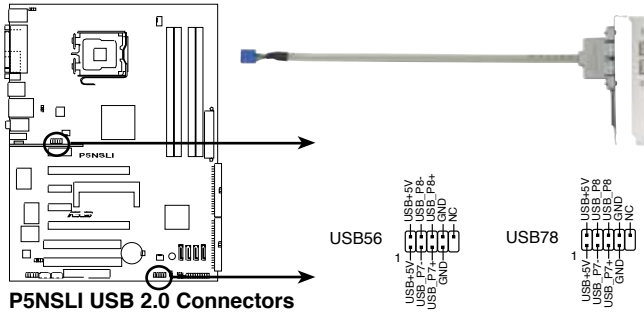

Never connect a **1394 cable** to the USB connectors. Doing so will damage the motherboard!

6. Azalia Analog Front Panel (10-1 pin AAFP)

This connector is for a chassis-mounted front panel audio I/O module that supports legacy AC '97 audio standard. Connect one end of the front panel audio I/O module cable to this connector.

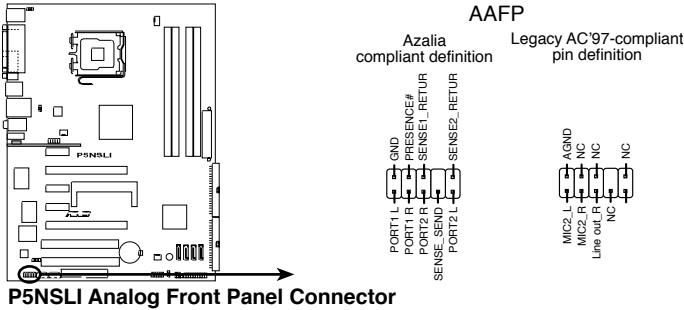

7. CPU, Power and Chassis Fan connectors (4-pin CPU_FAN, 3-pin PWR_FAN, 3-pin CHA_FAN)

The fan connectors support cooling fans of 350 mA ~ 2000 mA (24 W max.) or a total of 1 A ~ 3.48 A (41.76 W max.) at +12V. Connect the fan cables to the fan connectors on the motherboard, making sure that the black wire of each cable matches the ground pin of the connector.



Do not forget to connect the fan cables to the fan connectors. Insufficient air flow inside the system may damage the motherboard components. These are not jumpers! Do not place jumper caps on the fan connectors!

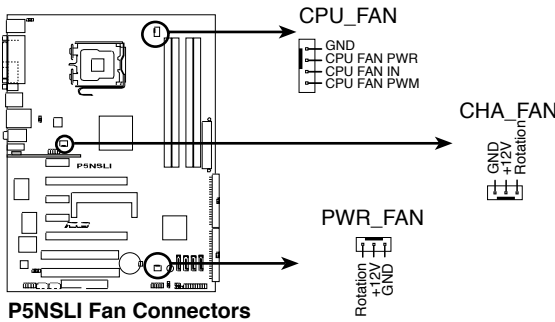

Only the CPU_FAN connector support the ASUS Q-Fan feature.

8. Chassis intrusion connector (4-1 pin CHASSIS)

This connector is for a chassis-mounted intrusion detection sensor or switch. Connect one end of the chassis intrusion sensor or switch cable to this connector. The chassis intrusion sensor or switch sends a high-level signal to this connector when a chassis component is removed or replaced. The signal is then generated as a chassis intrusion event.

By default, the pins labeled “Chassis Signal” and “Ground” are shorted with a jumper cap. Remove the jumper caps only when you intend to use the chassis intrusion detection feature.

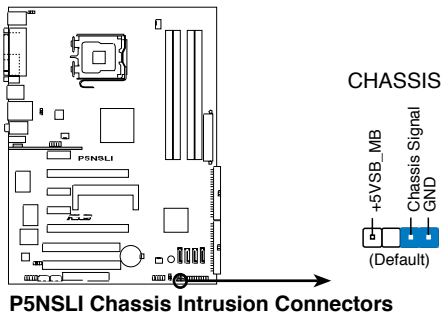

9. ATX power connectors (24-pin EATXPWR, 4-pin ATX12V)

These connectors are for ATX power supply plugs. The power supply plugs are designed to fit these connectors in only one orientation. Find the proper orientation and push down firmly until the connectors completely fit.

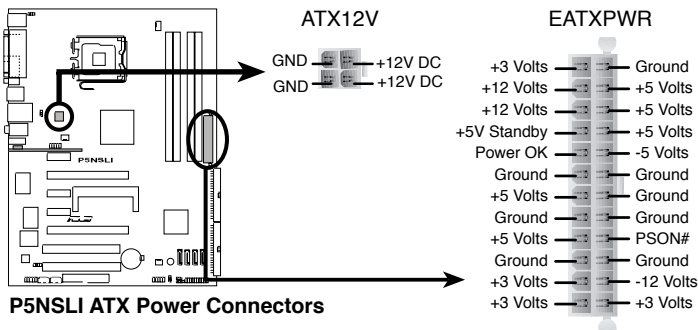



- For a fully configured system, we recommend that you use a power supply unit (PSU) that complies with ATX 12 V Specification 2.0 (or later version) and provides a minimum power of 400 W.
- Do not forget to connect the 4-pin ATX +12 V power plug; otherwise, the system will not boot.
- Use of a PSU with a higher power output is recommended when configuring a system with more power-consuming devices. The system may become unstable or may not boot up if the power is inadequate. See Table 2 for details.

Power supply requirements

Components/Peripherals	Loading		
	Heavy	Normal	Light
Intel® LGA775 CPU type	Intel Pentium EE	Intel Pentium D	Intel Pentium 4
PCIe™ x16 graphics cards	6800 Ultra x2	6800GT x2	6600GT x2
DDR DIMMs	4	2	2
HDD	4	2	2
Optical drive (DVD/CD-RW)	2	2	1
PCIe™ x 1 card	1	0	0
PCI cards	3	2	1
USB devices	6	4	3
Required +12V current	> 25A	> 20A	> 17A
Required wattage	>= 500W	>= 400W	>= 350W

10. ASUS EZ selector card connector (144-pin SLI_CON)

This connector is for the ASUS proprietary ASUS EZ selector card that allows you to set the SLI mode to either Single Video card or Dual Video cards.

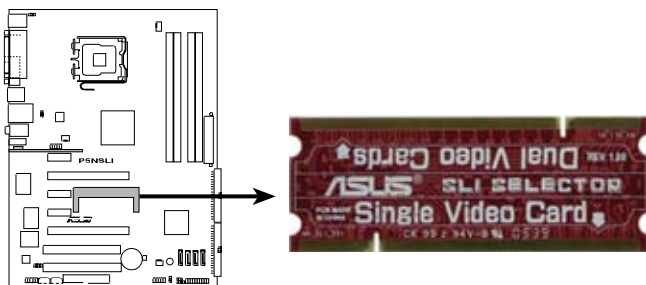

P5NSLI EZ Selector Card Connector



The EZ Selector card is set to Single Video Card by default.

11. System panel connector (20-pin PANEL)

This connector supports several chassis-mounted functions.

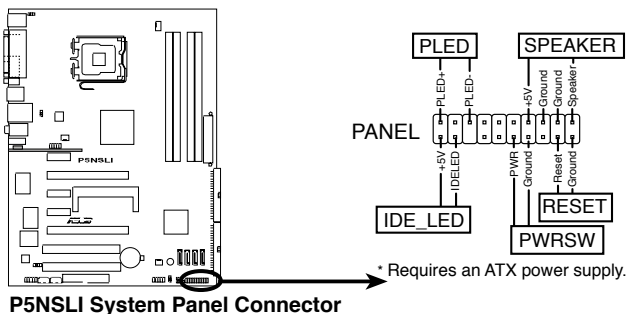

The system panel connector is color-coded for easy connection. Refer to the connector description below for details.

- **System power LED (3-pin PLED)**
This 3-pin connector is for the system power LED. Connect the chassis power LED cable to this connector. The system power LED lights up when you turn on the system power, and blinks when the system is in sleep mode.
- **Hard disk drive activity LED (2-pin IDE_LED)**
This 2-pin connector is for the HDD Activity LED. Connect the HDD Activity LED cable to this connector. The IDE LED lights up or flashes when data is read from or written to the HDD.
- **System warning speaker (4-pin SPEAKER)**
This 4-pin connector is for the chassis-mounted system warning speaker. The speaker allows you to hear system beeps and warnings.
- **ATX power button/soft-off button (2-pin PWR)**
This connector is for the system power button. Pressing the power button turns the system on or puts the system in sleep or soft-off mode depending on the BIOS settings. Pressing the power switch for more than four seconds while the system is ON turns the system OFF.
- **Reset button (2-pin RESET)**
This 2-pin connector is for the chassis-mounted reset button for system reboot without turning off the system power.

Q-Connector (system panel)

You can use ASUS Q-Connector to connect / disconnect chassis front panel cables by only a few steps. Directions below shows how to install ASUS Q-Connector.

Step1.

Connect correct front panel to ASUS Q-Connector first. You can refer to the marking on Q-Connector itself to know the detail pin definition.

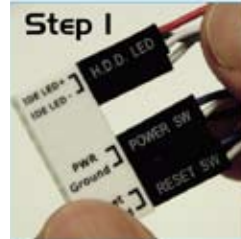

Step2.

Properly install the ASUS Q-Connector to the System panel connector.



Step3.

Front panel functions are enabled.

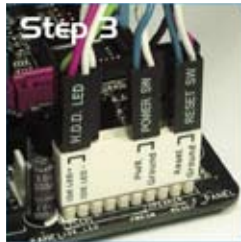

This chapter tells how to change the system settings through the BIOS Setup menus. Detailed descriptions of the BIOS parameters are also provided.

BIOS setup **2**

2.1 Managing and updating your BIOS

The following utilities allow you to manage and update the motherboard Basic Input/Output System (BIOS) setup.

1. **Award BIOS Flash Utility** (Updates the BIOS in DOS mode using a bootable floppy disk.)
2. **ASUS CrashFree BIOS 2** (Updates the BIOS using a bootable floppy disk or the motherboard support CD when the BIOS file fails or gets corrupted.)
3. **ASUS EZ Flash 2** (Updates the BIOS using a floppy disk, USB Flash, or the motherboard support CD during POST.)
4. **ASUS Update** (Updates the BIOS in Windows® environment.)

Refer to the corresponding sections for details on these utilities.



Save a copy of the original motherboard BIOS file to a bootable floppy disk in case you need to restore the BIOS in the future. Copy the original motherboard BIOS using the ASUS Update or AwardBIOS Flash utilities.

2.1.1 Creating a bootable floppy disk

1. Do either one of the following to create a bootable floppy disk.

DOS environment

- a. Insert a 1.44MB floppy disk into the drive.
- b. At the DOS prompt, type `format A: /S` then press <Enter>.

Windows® XP environment

- a. Insert a 1.44 MB floppy disk to the floppy disk drive.
- b. Click **Start** from the Windows® desktop, then select **My Computer**.
- c. Select the 3 1/2 Floppy Drive icon.
- d. Click **File** from the menu, then select **Format. A Format 3 1/2 Floppy Disk** window appears.
- e. Select **Create an MS-DOS startup disk** from the format options field, then click Start.

Windows® 2000 environment

To create a set of boot disks for Windows® 2000:

- a. Insert a formatted, high density 1.44 MB floppy disk into the drive.
- b. Insert the Windows® 2000 CD to the optical drive.

- c. Click **Start**, then select **Run**.
 - d. From the Open field, type
`D:\bootdisk\makeboot a:`
 assuming that D: is your optical drive.
 - e. Press <Enter>, then follow screen instructions to continue.
2. Copy the original or the latest motherboard BIOS file to the bootable floppy disk.

2.1.2 Updating the BIOS

The Basic Input/Output System (BIOS) can be updated using the AwardBIOS Flash Utility. Follow these instructions to update the BIOS using this utility.

1. Download the latest BIOS file from the ASUS web site. Rename the file to **P5NSLI.BIN** and save it to a floppy disk.



Save only the updated BIOS file in the floppy disk to avoid loading the wrong BIOS file.

2. Copy the AwardBIOS Flash Utility (awdfash.exe) from the Software folder of the support CD to the floppy disk with the latest BIOS file.
3. Boot the system in DOS mode using the bootable floppy disk you created earlier.
4. When the **A:>** appears, replace the bootable floppy disk with the floppy disk containing the new BIOS file and the Award BIOS Flash Utility.
5. At the prompt, type **awdfash** then press <Enter>. The Award BIOS Flash Utility screen appears.

```

AwardBIOS Flash Utility for ASUS V1.08
(C) Phoenix Technologies Ltd. All Rights Reserved

For NF-KC804-P5NSLI-00      DATE: 09/25/2005
Flash Type - SST 49LF004A/B /3.3V

File Name to Program: 

Message: Please input File Name!
  
```

6. Type the BIOS file name in the **File Name to Program** field, then press <Enter>.

```
AwardBIOS Flash Utility for ASUS V1.08
(C) Phoenix Technologies Ltd. All Rights Reserved

For NF-KC804-P5NSLI-00      DATE: 03/25/2005
Flash Type - SST 49LF004A/B /3.3V

File Name to Program: P5NSLI.bin

Message: Do You Want To Save Bios (Y/N)
```

7. Press <N> when the utility prompts you to save the current BIOS file. The following screen appears.
8. The utility verifies the BIOS file in the floppy disk and starts flashing the BIOS file.

```
AwardBIOS Flash Utility for ASUS V1.08
(C) Phoenix Technologies Ltd. All Rights Reserved

For NF-KC804-P5NSLI-00      DATE: 03/25/2005
Flash Type - SST 49LF004A/B /3.3V

File Name to Program: P5NSLI.bin

Program Flashing Memory - OFE00 OK

Write OK      No Update      Write Fail

Warning: Don't Turn Off Power Or Reset System!
```



Do not turn off or reset the system during the flashing process!

9. The utility displays a **Flashing Complete** message indicating that you have successfully flashed the BIOS file. Remove the floppy disk then press <F1> to restart the system.

```
AwardBIOS Flash Utility for ASUS V1.08
(C) Phoenix Technologies Ltd. All Rights Reserved

For NF-KC804-P5NSLI-00      DATE: 03/25/2005
Flash Type - SST 49LF004A/B /3.3V

File Name to Program: P5NSLI.bin

Flashing Complete
Press <F1> to Continue

Write OK      No Update      Write Fail

F1 Reset
```

2.1.3 Saving the current BIOS file

You can use the AwardBIOS Flash Utility to save the current BIOS file. You can load the current BIOS file when the BIOS file gets corrupted during the flashing process.



Make sure that the floppy disk has enough disk space to save the file.

To save the current BIOS file using the AwardBIOS Flash Utility:

1. Follow steps 1 to 6 of the previous section.
2. Press <Y> when the utility prompts you to save the current BIOS file. The following screen appears.

```
AwardBIOS Flash Utility for ASUS V1.08
(C) Phoenix Technologies Ltd. All Rights Reserved

For NF-KC804-P5NSLI-00      DATE: 03/25/2005
Flash Type - SST 49LF004A/B /3.3V

File Name to Program: 1001.bin
Save current BIOS as:

Message:
```

3. Type a filename for the current BIOS file in the **Save current BIOS as** field, then press <Enter>.

```
AwardBIOS Flash Utility for ASUS V1.08
(C) Phoenix Technologies Ltd. All Rights Reserved

For NF-KC804-P5NSLI-00      DATE: 03/25/2005
Flash Type - SST 49LF004A/B /3.3V

File Name to Program: 1001.bin
Checksum: DAD6H
Save current BIOS as: old.bin

Message: Please Wait!
```

4. The utility saves the current BIOS file to the floppy disk, then returns to the BIOS flashing process.

```
AwardBIOS Flash Utility for ASUS V1.08
(C) Phoenix Technologies Ltd. All Rights Reserved

For NF-KC804-P5NSLI-00      DATE: 03/25/2005
Flash Type - SST 49LF004A/B /3.3V

File Name to Program: 1001.bin
Now Backup System BIOS to
File!

Message: Please Wait!
```

2.1.4 ASUS CrashFree BIOS 2 utility

The ASUS CrashFree BIOS 2 is an auto recovery tool that allows you to restore the BIOS file when it fails or gets corrupted during the updating process. You can update a corrupted BIOS file using the motherboard support CD or the floppy disk that contains the updated BIOS file.



Prepare the motherboard support CD or the floppy disk containing the updated motherboard BIOS before using this utility.

Recovering the BIOS from the support CD

To recover the BIOS from the support CD:

1. Turn on the system.
2. Insert the motherboard support CD to the optical drive.
3. The utility displays the following message and automatically checks the CD for the BIOS file.

```
Award BootBlock BIOS v1.0
Copyright (c) 2000, Award Software, Inc.

BIOS ROM checksum error
Detecting IDE ATAPI device...
```

When found, the utility reads the BIOS file and starts flashing the corrupted BIOS file.

```
Award BootBlock BIOS v1.0
Copyright (c) 2000, Award Software, Inc.

BIOS ROM checksum error
Detecting IDE ATAPI device...
Found CDROM, try to Boot from it... Pass
```



DO NOT shut down or reset the system while updating the BIOS! Doing so can cause system boot failure!

4. Restart the system after the utility completes the updating process.

Recovering the BIOS from a floppy disk

To recover the BIOS from the floppy disk:

1. Remove any CD from the optical drive, then turn on the system.
2. Insert the floppy disk with the original or updated BIOS file to the floppy disk drive.
3. The utility displays the following message and automatically checks the optical drive for the original or updated BIOS file.

```
Award BootBlock BIOS v1.0
Copyright (c) 2000, Award Software, Inc.

BIOS ROM checksum error
Detecting IDE ATAPI device...
```

When no CD is found, the utility automatically checks the floppy disk for the original or updated BIOS file. The utility then updates the corrupted BIOS file.

```
Award BootBlock BIOS v1.0
Copyright (c) 2000, Award Software, Inc.

BIOS ROM checksum error
Detecting IDE ATAPI device...
  Found CDROM, try to Boot from it.. Fail

Detecting floppy drive A media...
```



DO NOT shut down or reset the system while updating the BIOS! Doing so can cause system boot failure!

4. Restart the system after the utility completes the updating process.



The recovered BIOS may not be the latest BIOS version for this motherboard. Visit the ASUS website (www.asus.com) to download the latest BIOS file.

2.1.5 ASUS EZ Flash 2 utility

The ASUS EZ Flash 2 feature allows you to update the BIOS without having to go through the long process of booting from a floppy disk and using a DOS-based utility. The EZ Flash 2 utility is built-in the BIOS chip so it is accessible by pressing <Alt> + <F2> during the Power-On Self-Test (POST).

To update the BIOS using EZ Flash 2:

1. Visit the ASUS website (www.asus.com) to download the latest BIOS file for the motherboard.
2. Save the BIOS file to a floppy disk or a USB flash disk, then restart the system.
3. You can launch the EZ Flash 2 by two methods.
 - (1) Insert the floppy disk / USB flash disk that contains the BIOS file to the floppy disk drive or the USB port.

Press <Alt> + <F2> during POST to display the following.

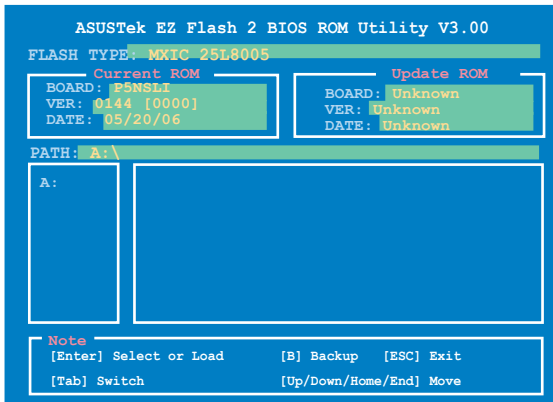

- (2) Enter BIOS setup program. Go to the Tools menu to select EZ Flash2 and press <Enter> to enable it.
You can switch between drives by pressing <Tab> before the correct file is found. Then press <Enter>.
4. When the correct BIOS file is found, EZ Flash 2 performs the BIOS update process and automatically reboots the system when done.



- This function can support devices such as USB flash disk, or floppy disk with FAT 32/16 format only.
- Do not shut down or reset the system while updating the BIOS to prevent system boot failure!

2.1.6 ASUS Update utility

The ASUS Update is a utility that allows you to manage, save, and update the motherboard BIOS in Windows® environment. The ASUS Update utility allows you to:

- Save the current BIOS file
- Download the latest BIOS file from the Internet
- Update the BIOS from an updated BIOS file
- Update the BIOS directly from the Internet, and
- View the BIOS version information.

This utility is available in the support CD that comes with the motherboard package.



ASUS Update requires an Internet connection either through a network or an Internet Service Provider (ISP).

Installing ASUS Update

To install ASUS Update:

1. Place the support CD in the optical drive. The Drivers menu appears.
2. Click the Utilities tab, then click Install ASUS Update VX.XX.XX. See page 3-4 for the Utilities screen menu.
3. The ASUS Update utility is copied to your system.



Quit all Windows® applications before you update the BIOS using this utility.

Updating the BIOS through the Internet

To update the BIOS through the Internet:

1. Launch the ASUS Update utility from the Windows® desktop by clicking **Start > Programs > ASUS > ASUSUpdate > ASUSUpdate**. The ASUS Update main window appears.

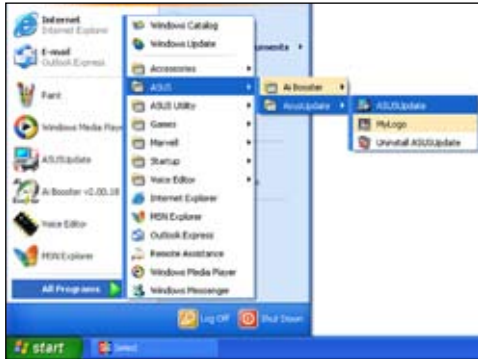

2. Select **Update BIOS from the Internet** option from the drop-down menu, then click **Next**.



3. Select the ASUS FTP site nearest you to avoid network traffic, or click **Auto Select**. Click **Next**.

- From the FTP site, select the BIOS version that you wish to download. Click Next.
- Follow the screen instructions to complete the update process.



The ASUS Update utility is capable of updating itself through the Internet. Always update the utility to avail all its features.



Updating the BIOS through a BIOS file

To update the BIOS through a BIOS file:

- Launch the ASUS Update utility from the Windows® desktop by clicking **Start > Programs > ASUS > ASUSUpdate > ASUSUpdate**. The ASUS Update main window appears.
- Select **Update BIOS from a file** option from the drop-down menu, then click **Next**.



- Locate the BIOS file from the **Open** window, then click **Open**.
- Follow the screen instructions to complete the update process.

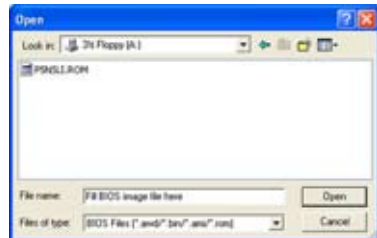

2.2 BIOS setup program

This motherboard supports a programmable Low-Pin Count (LPC) chip that you can update using the provided utility described in section “2.1 Managing and updating your BIOS.”

Use the BIOS Setup program when you are installing a motherboard, reconfiguring your system, or prompted to “Run Setup”. This section explains how to configure your system using this utility.

Even if you are not prompted to use the Setup program, you can change the configuration of your computer in the future. For example, you can enable the security password feature or change the power management settings. This requires you to reconfigure your system using the BIOS Setup program so that the computer can recognize these changes and record them in the CMOS RAM of the LPC chip.

The LPC chip on the motherboard stores the Setup utility. When you start up the computer, the system provides you with the opportunity to run this program. Press during the Power-On Self-Test (POST) to enter the Setup utility; otherwise, POST continues with its test routines.

If you wish to enter Setup after POST, restart the system by pressing <Ctrl>+<Alt>+, or by pressing the reset button on the system chassis. You can also restart by turning the system off and then back on. Do this last option only if the first two failed.

The Setup program is designed to make it as easy to use as possible. Being a menu-driven program, it lets you scroll through the various sub-menus and make your selections from the available options using the navigation keys.



-
- The default BIOS settings for this motherboard apply for most conditions to ensure optimum performance. If the system becomes unstable after changing any BIOS settings, load the default settings to ensure system compatibility and stability. Select the Load Default Settings item under the Exit Menu. See section “2.8 Exit Menu.”
 - The BIOS setup screens shown in this section are for reference purposes only, and may not exactly match what you see on your screen.
 - Visit the ASUS website (www.asus.com) to download the latest BIOS file for this motherboard and .
-

2.2.1 BIOS menu screen

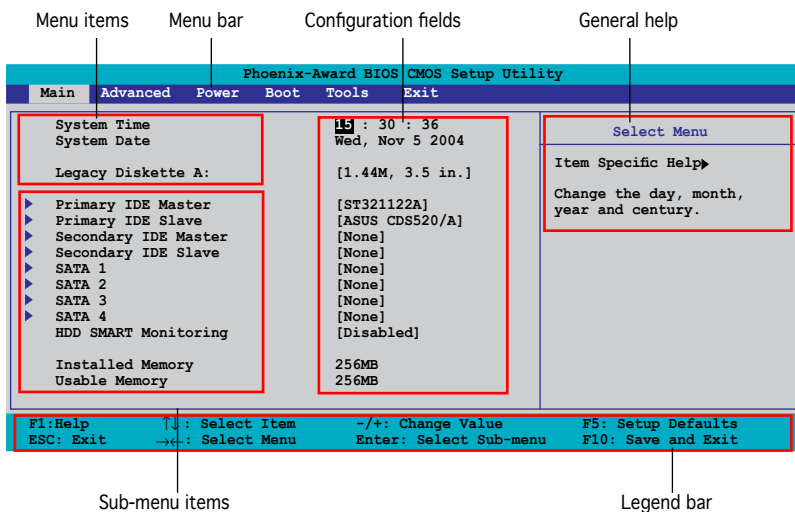

2.2.2 Menu bar

The menu bar on top of the screen has the following main items:

- Main** For changing the basic system configuration
- Advanced** For changing the advanced system settings
- Power** For changing the advanced power management (APM) configuration
- Boot** For changing the system boot configuration
- Exit** For selecting the exit options and loading default settings

To select an item on the menu bar, press the right or left arrow key on the keyboard until the desired item is highlighted.



- The BIOS setup screens shown in this chapter are for reference purposes only, and may not exactly match what you see on your screen.
- Visit the ASUS website (www.asus.com) to download the latest BIOS information.

2.2.3 Legend bar

At the bottom of the Setup screen is a legend bar. The keys in the legend bar allow you to navigate through the various setup menus. The following table lists the keys found in the legend bar with their corresponding functions.

Navigation Key	Function
<F1>	Displays the General Help screen
<F5>	Loads setup default values
<Esc>	Exits the BIOS setup or returns to the main menu from a sub-menu
Left or Right arrow	Selects the menu item to the left or right
Up or Down arrow	Moves the highlight up or down between fields
Page Down or - (minus)	Scrolls backward through the values for the highlighted field
Page Up or + (plus)	Scrolls forward through the values for the highlighted field
<Enter>	Brings up a selection menu for the highlighted field
<F10>	Saves changes and exit

2.2.4 Menu items

The highlighted item on the menu bar displays the specific items for that menu. For example, selecting Main shows the **Main** menu items.

The other items (Advanced, Power, Boot, and Exit) on the menu bar have their respective menu items.

2.2.5 Sub-menu items

A solid triangle before each item on any menu screen means that the item has a sub-menu. To display the sub-menu, select the item and press <Enter>.

2.2.6 Configuration fields

These fields show the values for the menu items. If an item is user-configurable, you can change the value of the field opposite the item. You cannot select an item that is not user-configurable.

A configurable field is enclosed in brackets, and is highlighted when selected. To change the value of a field, select it then press <Enter> to display a list of options. Refer to “2.2.7 Pop-up window.”

2.2.7 Pop-up window

Select a menu item then press <Enter> to display a pop-up window with the configuration options for that item.

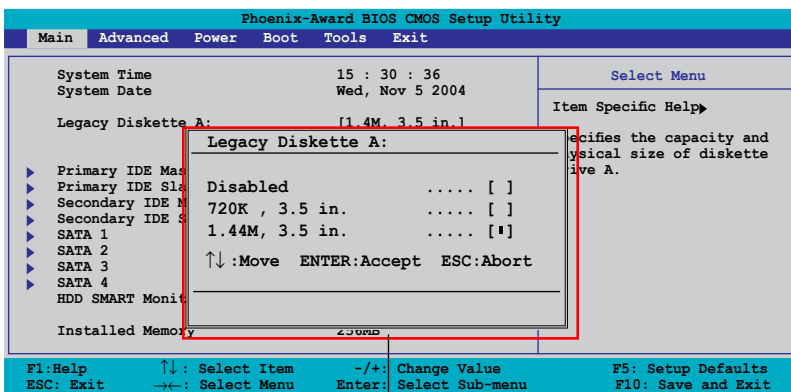

Pop-up menu

2.2.8 General help

At the top right corner of the menu screen is a brief description of the selected item.

2.3 Main menu

When you enter the BIOS Setup program, the Main menu screen appears, giving you an overview of the basic system information.



Refer to section “2.2.1 BIOS menu screen” for information on the menu screen items and how to navigate through them.

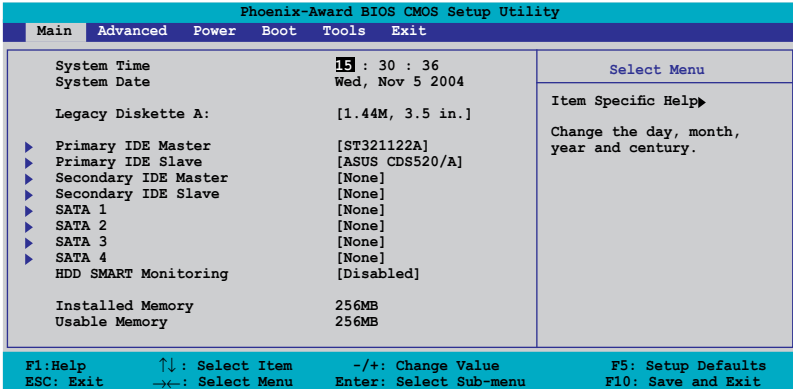

2.3.1 System Time [xx:xx:xxxx]

Allows you to set the system time.

2.3.2 System Date [Day xx/xx/xxxx]

Allows you to set the system date.

2.3.3 Legacy Diskette A [1.44M, 3.5 in.]

Sets the type of floppy drive installed. Configuration options: [Disabled]
[720K , 3.5 in.] [1.44M, 3.5 in.]

2.3.4 Primary and Secondary IDE Master/Slave

While entering Setup, the BIOS automatically detects the presence of IDE devices. There is a separate sub-menu for each IDE device. Select a device item then press <Enter> to display the IDE device information.

Phoenix-Award BIOS CMOS Setup Utility		
Main		
	Primary IDE Master	Select Menu
Primary IDE Master	[Auto]	Item Specific Help▶▶ Press [Enter] to select
Access Mode	[Auto]	
Capacity	xxxxx MB	
Cylinder	xxxxx	
Head	xx	
Sector	xx	
PIO Mode	[Auto]	
UDMA Mode	[Auto]	
Transfer Mode	xxxxxxxx	
F1: Help ↑↓: Select Item -/+ : Change Value F5: Setup Defaults		
ESC: Exit →←: Select Menu Enter: Select Sub-menu F10: Save and Exit		

The BIOS automatically detects the values opposite the dimmed items (Capacity, Cylinder, Head, Sector and Transfer Mode). These values are not user-configurable. These items show N/A if no IDE device is installed in the system.

Primary IDE Master/Slave [Auto]; Secondary IDE Master/Slave [Auto]

Select [Auto] to automatically detect an IDE hard disk drive. If automatic detection is successful, the BIOS automatically fills in the correct values for the remaining fields on this sub-menu. If the hard disk was already formatted on a previous system, the setup BIOS may detect incorrect parameters. Select [Manual] to manually enter the IDE hard disk drive parameters. If no drive is installed select [None].

Configuration options: [None] [Auto] [Manual]

Access Mode [Auto]

The default [Auto] allows automatic detection of an IDE hard disk drive. Select [CHS] for this item if you set the IDE Primary Master/Slave to [Manual]. Configuration options: [CHS] [LBA] [Large] [Auto]



Before attempting to configure a hard disk drive, make sure you have the correct configuration information supplied by the drive manufacturer. Incorrect settings may cause the system to fail to recognize the installed hard disk.

Capacity

Displays the auto-detected hard disk capacity. This item is not configurable.

Cylinder

Shows the number of the hard disk cylinders. This item is not configurable.

Head

Shows the number of the hard disk read/write heads. This item is not configurable.

Sector

Shows the number of sectors per track. This item is not configurable.

PIO Mode [Auto]

Sets the PIO mode for the IDE device.

Configuration options: [Auto] [Mode 0] [Mode 1] [Mode 2] [Mode 3] [Mode 4]

UDMA Mode [Auto]

Disables or sets the UDMA mode. Configuration options: [Disable] [Auto]

Transfer Mode

Shows the Transfer mode. This item is not configurable.



After entering the IDE hard disk drive information into BIOS, use a disk utility, such as FDISK, to partition and format new IDE hard disk drives. This is necessary so that you can write or read data from the hard disk. Make sure to set the partition of the Primary IDE hard disk drives to active.

2.3.5 SATA1, SATA2, SATA3,SATA4

While entering Setup, the BIOS automatically detects the presence of Serial ATA devices. There is a separate sub-menu for each SATA device. Select a device item then press <Enter> to display the SATA device information.

Phoenix-Award BIOS CMOS Setup Utility		
Main		
	Primary IDE Master	Select Menu
Extended IDE Drive Access Mode	[Auto] [Auto]	Item Specific Help▶▶ Press [Enter] to select
Capacity	xxxxxx MB	
Cylinder	xxxxxx	
Head	xx	
Precomp	xx	
Landing Zone	xx	
Sector	xx	

F1: Help ↑↓: Select Item -/+ : Change Value F5: Setup Defaults
ESC: Exit →←: Select Menu Enter: Select Sub-menu F10: Save and Exit

The BIOS automatically detects the values opposite the dimmed items (Capacity, Cylinder, Head, Precomp, Landing Zone and Sector). These values are not user-configurable. These items show 0 if no SATA device is installed in the system.

Extended IDE Drive [Auto]

Selects the type of fixed disk connected to the system.
Configuration options: [None] [Auto]

Access Mode [Auto]

Sets the sector addressing mode. Configuration options: [Large] [Auto]



Before attempting to configure a hard disk drive, make sure you have the correct configuration information supplied by the drive manufacturer. Incorrect settings may cause the system to fail to recognize the installed hard disk.

Capacity

Displays the auto-detected hard disk capacity. This item is not configurable.

Cylinder

Shows the number of the hard disk cylinders. This item is not configurable.

Head

Shows the number of the hard disk read/write heads. This item is not configurable.

Precomp

Shows the number of precomp per track. This item is not configurable.

Landing Zone

Shows the number of landing zone per track. This item is not configurable.

Sector

Shows the number of sectors per track. This item is not configurable.



After entering the IDE hard disk drive information into BIOS, use a disk utility, such as FDISK, to partition and format new IDE hard disk drives. This is necessary so that you can write or read data from the hard disk. Make sure to set the partition of the Primary IDE hard disk drives to active.

2.3.6 HDD SMART Monitoring [Disabled]

Allows you to enable or disable the HDD Self-Monitoring Analysis and Reporting Technology (SMART) feature.

Configuration options: [Disabled] [Enabled]

2.3.7 Installed Memory

Shows the size of installed memory.

2.3.8 Usable Memory

Shows the size of usable memory.

2.4 Advanced menu

The Advanced menu items allow you to change the settings for the CPU and other system devices.



Take caution when changing the settings of the Advanced menu items. Incorrect field values can cause the system to malfunction.

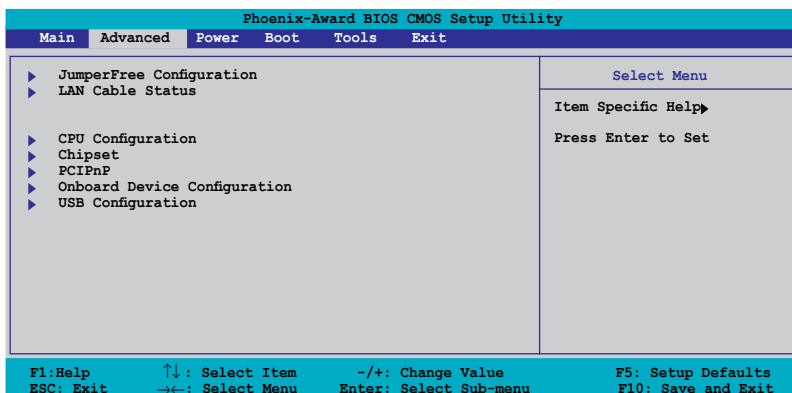

2.4.1 JumperFree Configuration

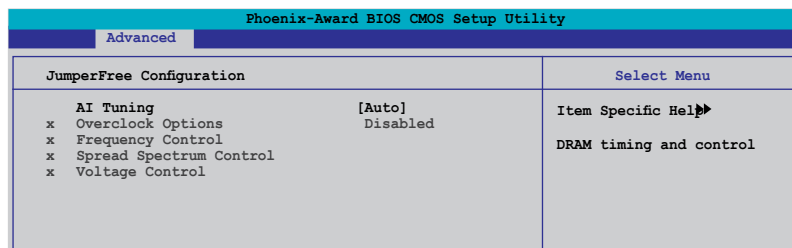

AI Tuning [Auto]

Allows selection of CPU overclocking options to achieve desired CPU internal frequency. Select either one of the preset overclocking configuration options:

Manual	Allows you to individually set overclocking parameters.
Auto	Loads the optimal settings for the system.
Standard	Loads the standard settings for the system.
AI Overclock	Loads overclocking profiles with optimal parameters for stability when overclocking.

Overclock Options [Disable]

Allows you to disable or set the overlocking options.

Configuration options: [Disabled] [Overclock 5%] [Overclock 10%]
[Overclock 15%] [Overclock 20%] [FSB 960/800] [FSB 1280/800]
[FSB 1000/667] [FSB 1333/667] [FSB 1200/800]



The Overclock Options item is user-configurable only when the AI Tuning is set to [AI Overclock].

Frequency Control

This sub-menu allows you to set CPU, PCI Express, and memory related fields. Set the AI Tuning to Manual, if you want to configure this item.

Phoenix-Award BIOS CMOS Setup Utility			
Advanced			
Frequency Control		Select Menu	
PCIE Frequency (MHz)	[100]	Item Specific Help▶▶	
System Clock Mode	[Auto]	Press [Enter] to Set.	
New FSB Speed (QDR)	Auto		
Current FSB Speed (QDR)	800.0 MHz		
Target FSB Speed (QDR)	800.0 MHz		
x New MEM Speed (DDR)	Auto		
Current MEM Speed (DDR)	533.3 MHz		
Target MEM Speed (DDR)	533.3 MHz		
F1: Help		↑↓: Select Item	-/+ : Change Value
ESC: Exit		→←: Select Menu	F5: Setup Defaults
		Enter: Select Sub-menu	F10: Save and Exit

PCIE Frequency [100]

Allows you to set the PCI Express frequency. Key-in a decimal value between 100-150 MHz. Configuration options: [100MHz] [101MHz] ~ [150MHz]



Selecting a very high PCIE frequency may cause the system to become unstable! If this happens, revert to the default setting.

System Clock Mode [Auto]

Sets the system clock mode. The default setting [Auto], automatically sets the FSB and memory speeds. Set to [CPU Precision Tweaker] if you want to set the FSB at 1MHz increment with the memory frequency adjusting accordingly, setting to [CPU/MEM manual-mode] allows you to manually input the CPU and memory frequency. When set to [MEM Precision Tweaker], you can manually set the memory frequency.

Configuration options: [Auto] [CPU Precision Tweaker] [CPU/MEM manual-mode] [MEM Precision Tweaker]

New FSB Speed (QDR) [800]

Allows you to key-in new FSB speed. The configuration options vary depending on the CPU installed.



The New FSB Speed (QDR) item is user-configurable only when the System Clock Mode is set to [CPU Precision Tweaker] or [CPU/MEM manual-mode].

Current FSB Speed (QDR)

Displays the current FSB speed.

Target FSB Speed (QDR)

Displays the target FSB speed.

New MEM Speed (DDR)

Allows you to key-in new memory speed. The configuration options vary depending on the DDR2 memory installed.



The New MEM Speed (QDR) item is user-configurable only when the System Clock Mode is set to [MEM Precision Tweaker] or [CPU/MEM manual-mode].

Current MEM Speed (QDR)

Displays the current MEM speed.

Target MEM Speed (QDR)

Displays the target MEM speed.

Spread Spectrum Control

This sub-menu allows you to set the CPU, PCI Express, Serial ATA, and Lightning Data Transport (LDT) clock generator spread spectrum. The spread spectrum is used to dynamically change the system frequency to minimize problems with electromagnetic interference (EMI). Set the AI Tuning to [Manual], if you want to configure this item.

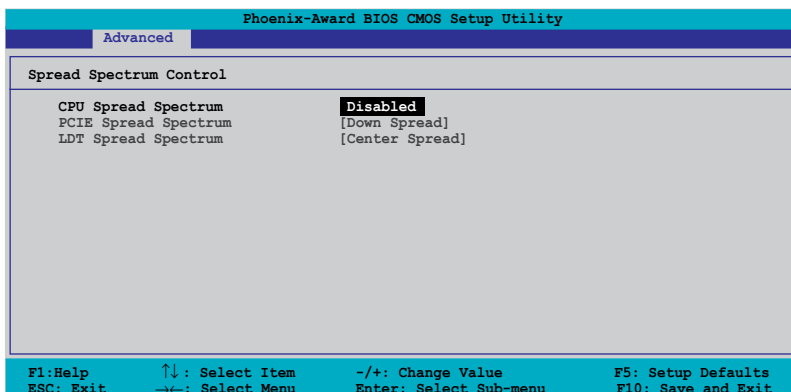

CPU Spread Spectrum [Center Spread]

Disables or sets the CPU clock generator spread spectrum. The default setting [Center Spread] allows a dynamic CPU frequency change of -0.25% to +0.25%. The [Down Spread] setting allows a dynamic CPU frequency change of -0.5% to 0.0%. Setting to [0.5%++ Spread] allows dynamic frequency changes from -0.5% to +0.5%. Configuration options: [Disabled] [Center Spread] [Down Spread] [0.5%++ Spread]

PCI Express Spread Spectrum [Down Spread]

Disables or sets the PCI Express clock generator spread spectrum. The default setting [Down Spread] allows a dynamic PCI Express frequency change of -0.5% to 0.0%. Configuration options: [Disabled] [Down Spread]

LDT Spread Spectrum [Center Spread]

Disables or sets the Lightning Data Transport (LDT) clock generator spread spectrum. The default setting [Center Spread] allows a dynamic LDT frequency change of -0.25% to +0.25%. Configuration options: [Disabled] [Center Spread] [Down Spread]

Voltage Control

This sub-menu allows you to set the system operating voltages. Set the AI Tuning to [Manual], if you want to configure this item.

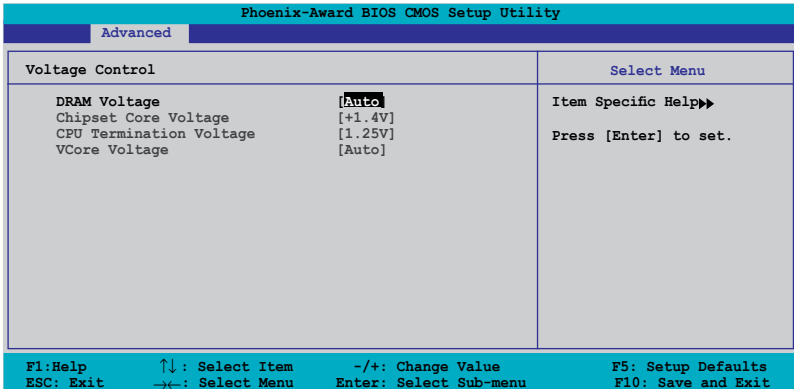

DRAM Voltage [Auto]

Allows you to set the DRAM operating voltage. Set to Auto for safe mode.
Configuration options: [Auto] [+1.800V] [+1.900V] [+2.000V]
[+2.100V]



Refer to the DDR2 documentation before setting the memory voltage.
Setting a very high memory voltage may damage the memory module(s)!

Chipset Core Voltage [+1.4V]

Allows you to set the chipset core voltage.
Configuration options: [+1.4V] [+1.5V]

CPU Termination Voltage [1.25V]

Allows you to set the CPU termination voltage.
Configuration options: [1.25V] [1.35V]

VCore Voltage [Auto]

Sets the operating VCore voltage. Configuration options: [Auto]

[1.6000V] [1.5875V] [1.5750V] [1.5625V] [1.5500V] [1.5375V]
[1.5250V] [1.5125V] [1.5000V] [1.4875V] [1.4750V] [1.4625V]
[1.4500V] [1.4375V] [1.4250V] [1.4125V] [1.4000V] [1.3875V]
[1.3750V] [1.3625V] [1.3500V] [1.3375V] [1.3250V] [1.3125V]
[1.3000V] [1.2875V] [1.2750V] [1.2625V] [1.2500V] [1.2375V]
[1.2250V] [1.2125V] [1.2000V] [1.1875V] [1.1750V] [1.1625V]
[1.1500V] [1.1375V] [1.1250V] [1.1125V] [1.1000V] [1.0875V]
[1.0750V] [1.0625V] [1.0500V] [1.0375V] [1.0250V] [1.0125V]
[1.0000V] [0.9875V] [0.9750V] [0.9625V] [0.9500V] [0.9375V]
[0.9250V] [0.9125V] [0.9000V] [0.8875V] [0.8750V] [0.8625V]
[0.8500V] [0.8375V]

2.4.2 LAN Cable Status

The items in this menu displays the status of the Local Area Network (LAN) cable.

The screenshot shows the Phoenix-Award BIOS CMOS Setup Utility. The title bar is 'Phoenix-Award BIOS CMOS Setup Utility' with a blue background. Below it is a dark blue bar with 'Advanced' in white. The main window is divided into two panes. The left pane is titled 'JumperFree Configuration' and shows 'AI NET2' set to 'Disabled'. Below this is a table with columns 'Pair', 'Status', and 'Length'. The right pane is titled 'Select Menu' and contains 'Item Specific Help' and 'Check LAN cable during POST.'. At the bottom, a blue bar contains navigation instructions: 'F1: Help', 'ESC: Exit', '↑↓: Select Item', '←→: Select Menu', '-/+ : Change Value', 'Enter: Select Sub-menu', 'F5: Setup Defaults', and 'F10: Save and Exit'.

JumperFree Configuration		Select Menu	
AI NET2	Disabled	Item Specific Help▶▶	
Pair	Status	Length	Check LAN cable during POST.
LAN1 (1-2)	Open	N/A	
LAN1 (3-4)	Open	N/A	
LAN1 (5-6)	Open	N/A	
LAN1 (7-8)	Open	N/A	

F1: Help ↑↓: Select Item -/+ : Change Value F5: Setup Defaults
ESC: Exit ←→: Select Menu Enter: Select Sub-menu F10: Save and Exit

AI NET2 [Disabled]

Enables or disables AI NET2 feature.

Configuration options: [Disabled] [Enabled]

2.4.3 CPU Configuration

Phoenix-Award BIOS CMOS Setup Utility		
Advanced		
CPU Configuration		Select Menu
CPU Type	Intel Pentium(R) 4	Item Specific Help▶▶
CPU Speed	3.80GHz	
Cache RAM	2048K	
CPU Clock Ratio	[6X]	DRAM timing and control
CPU Internal Thermal Control	[Auto]	
X TM2 Bus Ratio	14X	
X TM2 Bus VID	1.2000V	
Limit CPUID MaxVal	[Disabled]	
Enhanced C1 (C1E)	[Auto]	
Execute Disable Bit	[Enabled]	
Enhanced Intel SpeedStep(tm)Tech.	[Auto]	
Hyper-Threading Technology	[Enabled]	
Virtualization Technology	[Enabled]	

F1: Help ↑↓: Select Item -/+ : Change Value F5: Setup Defaults
ESC: Exit →←: Select Menu Enter: Select Sub-menu F10: Save and Exit

CPU Clock Ratio [9X]

Allows you to adjust the CPU clock ratio from 6 to 9.
Configuration options: [6X] [7X] [8X] [9X]

CPU Internal Thermal Control [Auto]

Enables or disables the CPU Internal Thermal Control feature.
Configurable options: [Auto] [Disabled]

TM2 Bus Ratio, VID

Displays the Thermal Monitor Bus Ratio and Voltage ID.

Limit CPUID MaxVal [Disabled]

Enables or disables the CPU ID maximum value limit.
Configuration options: [Disabled] [Enabled]

Enhanced C1 (C1E) [Auto]

When set to [Auto], the BIOS automatically check the CPU's capability to enable the C1E support. In C1E mode, the CPU power consumption is lower when idle. This item appears only when you install a processor with Enhanced C1E feature.
Configuration options: [Auto] [Disabled]

Excute Disable Bit [Enabled]

When disabled, the processor forces the XD feature flag to always return 0. Configuration options: [Disabled] [Enabled]

Enhanced Intel SpeedStep(tm) Tech. [Auto]

Allows you to use the Enhanced Intel SpeedStep® Technology. When set to [Auto], you can adjust the system power settings in the operation system to use the EIST feature. Set this item to [Disabled] if you do not want to use the EIST.

Configuration options: [Auto] [Disabled]

Hyper-Threading Technology [Enabled]

Enables or disables the Intel® Hyper-Threading Technology feature. This item appears only when you install a Hyper-Treading CPU.

Configuration options: [Disabled] [Enabled]

Virtualization Technology [Enabled]

Allows you to enable or disable Virtualization Technology.

Configuration options: [Disabled] [Enabled]

2.4.4 Chipset

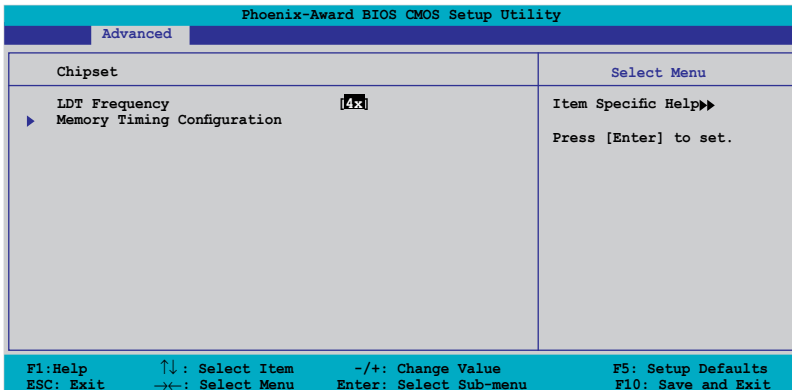

LDT Frequency [4x]

Sets the Lightning Data Transport (LDT) frequency multiplier.

Configuration options: [1x] [2x] [3x] [4x] [5x] [3.5x]

Memory Timing Configuration

This sub-menu allows you to set the memory timing configuration. Set the Memory Timings to [Manual], if you want to configure this item.

Phoenix-Award BIOS CMOS Setup Utility		
Advanced		
CPU/Memory Configuration		Select Menu
Memory Timings	[Auto]	Item Specific Help▶▶
x T (CAS)	Auto	Select [Expert] to enter timings manually
x T (RCD)	Auto	
x T (RP)	Auto	
x T (RAS)	Auto	
x T (RC)	Auto	
x Addressing Mode	Auto	
F1: Help ↑↓ : Select Item -/+ : Change Value F5: Setup Defaults ESC: Exit →← : Select Menu Enter: Select Sub-menu F10: Save and Exit		

Memory Timings [Auto]

Allows you to set the memory timing parameters. The default setting [Auto], automatically configures the memory timings. Set to [Manual] if you want to input the memory timings manually.

T (CAS) [Auto]

Controls the latency between the SDRAM read command and the time the data actually becomes available.

Configuration options: [Auto] [1] [2] [3] [4] [5] [6]

T (RCD) [Auto]

Sets the RAS-to-CAS delay timing.

Configuration options: [Auto] [1] [2] [3] [4] [5] [6] [7]

T (RP) [Auto]

Sets the row-precharge delay timing.

Configuration options: [Auto] [1] [2] [3] [4] [5] [6] [7]

T (RAS) [Auto]

Sets the row-active delay timing.

Configuration options: [Auto] [1] [2] ~ [31]

T (RC) [Auto]

Sets the row cycle timing.

Configuration options: [Auto] [1] [2] ~ [31]

Addressing Mode [Auto]

Allows you to enable two-clock addressing.

Configuration options: [Auto] [1 clock] [2 clock]

2.4.5 PCIPnP

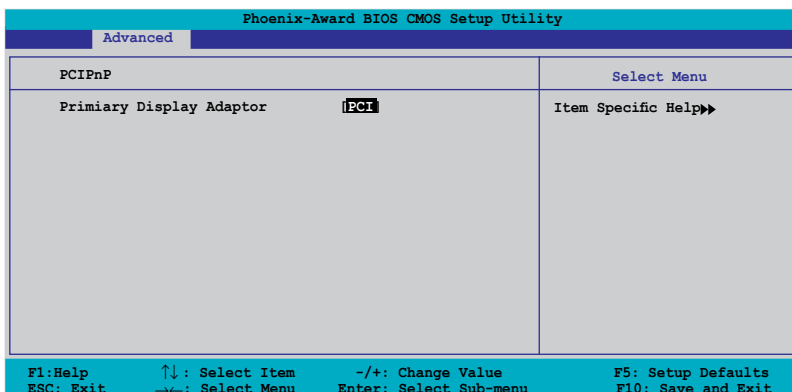

Primary Display Adaptor [PCI]

Allows you to set which graphics controller to use as primary boot device.
Configuration options: [PCI] [PCI-E]

2.4.6 Onboard Devices Configuration

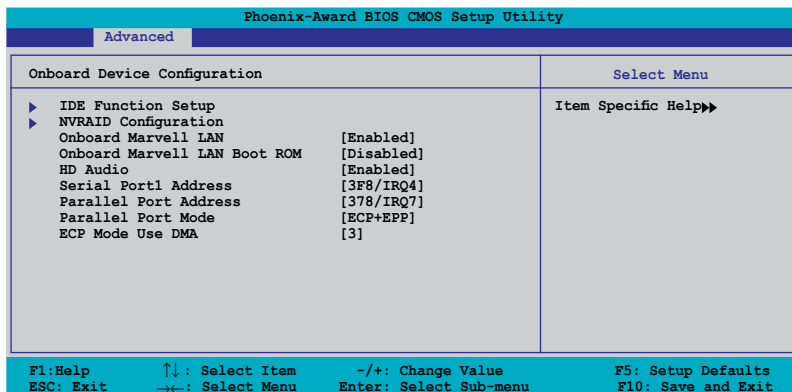

IDE Function Setup

This sub-menu contains IDE function-related items. Select an item then press <Enter> to edit.

Phoenix-Award BIOS CMOS Setup Utility		
Advanced		
IDE Function Setup		Select Menu
OnChip IDE Channel0	[Enabled]	Item Specific Help▶▶
OnChip IDE Channel1	[Enabled]	
IDE DMA transfer access	[Enabled]	Disable/Enable OnChip
SATA Port 1, 2	[Enabled]	IDE Channel0
SATA DMA transfer	[Enabled]	
SATA Port 3, 4	[Enabled]	
SATA2 DMA transfer	[Enabled]	
IDE Prefetch Mode	[Enabled]	

F1: Help ↑↓ : Select Item -/+ : Change Value F5: Setup Defaults
ESC: Exit →← : Select Menu Enter: Select Sub-menu F10: Save and Exit

OnChip IDE Channel0 [Enabled]

Allows you to enable or disable the onchip IDE channel 0 controller .
Configuration options: [Disabled] [Enabled]

OnChip IDE Channel1 [Enabled]

Allows you to enable or disable the onchip IDE channel 1 controller .
Configuration options: [Disabled] [Enabled]

IDE DMA transfer access [Enabled]

Allows you to enable or disable the IDE DMA transfer access.
Configuration options: [Disabled] [Enabled]

SATA Port 1, 2 [Enabled]

Allows you to enable or disable the SATA 1 and 2 ports.
Configuration options: [Disabled] [Enabled]

SATA DMA transfer [Enabled]

Allows you to enable or disable the SATA DMA transfer access.
Configuration options: [Disabled] [Enabled]

SATA Port 3, 4 [Enabled]

Allows you to enable or disable the SATA 3 and 4 ports.
Configuration options: [Disabled] [Enabled]

SATA2 DMA transfer [Enabled]

Allows you to enable or disable the SATA2 DMA transfer access.
Configuration options: [Disabled] [Enabled]

IDE Prefetch Mode [Enabled]

Allows you to enable or disable the IDE prefetch mode.
Configuration options: [Disabled] [Enabled]

NVRAID Configuration

This sub-menu contains NVRAID function-related items. Select an item then press <Enter> to edit.

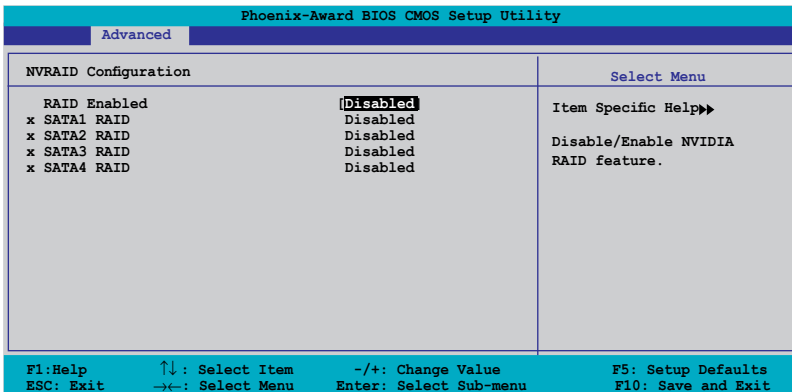

RAID Enabled [Disabled]

Enables or disables the onboard RAID controller. When Enabled, the succeeding items becomes user-configurable.
Configuration options: [Enabled] [Disabled]

SATA1, SATA2, SATA3, SATA4 RAID [Disabled]

Enables or disables the RAID function of the SATA1, SATA2, SATA3 or SATA4 master drive. Configuration options: [Enabled] [Disabled]

Onboard Marvell LAN [Enabled]

Enables or disables the onboard NVIDIA® Gigabit LAN controller.
Configuration options: [Disabled] [Enabled]

OnBoard Marvell LAN Boot ROM [Disabled]

Allows you to enable or disable the onboard NVIDIA® LAN boot ROM.
Configuration options: [Disabled] [Enabled]

HD Audio [Enabled]

Allows you to disable or enable the onboard HD audio controller.
Configuration options: [Disabled] [Enabled]

Serial Port1 Address [3F8/IRQ4]

Allows you to select the Serial Port1 base address.
Configuration options: [Disabled] [3F8/IRQ4] [2F8/IRQ3] [3E8/IRQ4] [2E8/IRQ3] [Auto]

Parallel Port Address [378/IRQ7]

Allows you to select the Parallel Port base addresses.
Configuration options: [Disabled] [378/IRQ7] [278/IRQ5] [3BC/IRQ7]

Parallel Port Mode [ECP+EPP]

Allows you to select the Parallel Port mode.
Configuration options: [SPP] [EPP] [ECP] [ECP+EPP]

ECP Mode Use DMA [3]

Allows selection of ECP Mode. Configuration options: [1] [3]

2.4.7 USB Configuration

The items in this menu allows you to change the USB-related features. Select an item then press <Enter> to display the configuration options.

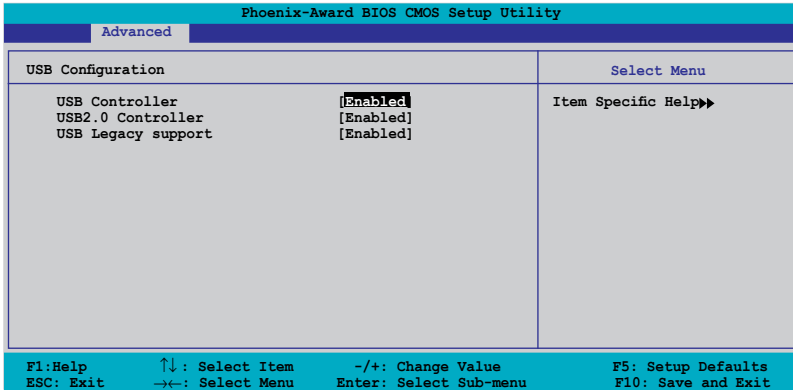

USB Controller [Enabled]

Allows you to enable or disable the onchip USB controller.
Configuration options: [Disabled] [Enabled]

USB 2.0 Controller [Enabled]

Allows you to enable or disable the USB 2.0 controller.
Configuration options: [Disabled] [Enabled]

USB Legacy Support [Enabled]

Allows you to enable or disable support for USB devices on legacy operating systems (OS). Configuration options: [Disabled] [Enabled]

2.5 Power menu

The Power menu items allow you to change the settings for the Advanced Configuration and Power Interface (ACPI) and the Advanced Power Management (APM). Select an item then press <Enter> to display the configuration options.

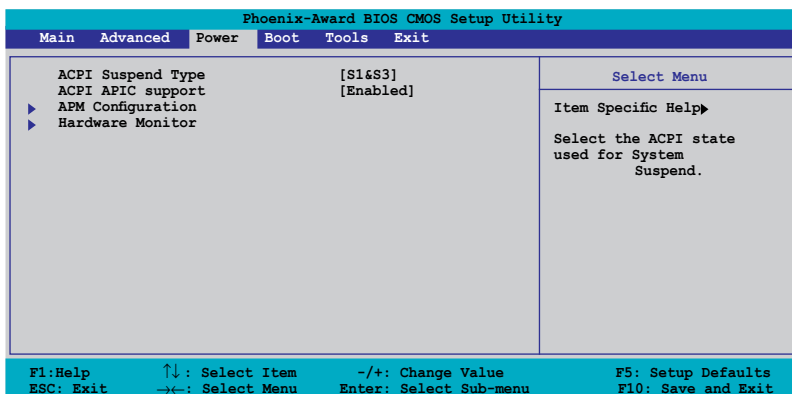

2.5.1 ACPI Suspend Type [S1&S3]

Allows you to select the Advanced Configuration and Power Interface (ACPI) state to be used for system suspend.

Configuration options: [S1 (POS)] [S3 (STR)] [S1&S3]

2.5.2 ACPI APIC Support [Enabled]

Allows you to enable or disable the Advanced Configuration and Power Interface (ACPI) support in the Application-Specific Integrated Circuit (ASIC). When set to Enabled, the ACPI APIC table pointer is included in the RSDT pointer list. Configuration options: [Disabled] [Enabled]

2.5.3 APM Configuration

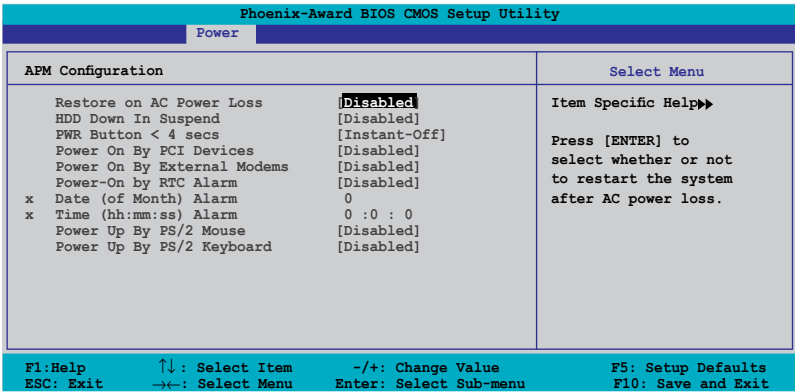

Restore on AC Power Loss [Disabled]

Allows you to enable or disable the Restore on AC Power Loss function.
 Configuration options: [Disabled] [Enabled]

HDD Down In Suspend [Disabled]

Allows you to enable or disable the HDD Down In Suspend feature.
 Configuration options: [Disabled] [Enabled]

PWR Button < 4 secs [Instant-Off]

Allows you to set the event after the power button is pressed for more than 4 seconds. Configuration options: [Suspend] [Instant-Off]

Power On By PCI Devices [Disabled]

When set to [Enabled], this parameter allows you to turn on the system through a PCI LAN or modem card. This feature requires an ATX power supply that provides at least 1A on the +5VSB lead.
 Configuration options: [Disabled] [Enabled]

Power On By External Modems [Disabled]

This allows either settings of [Enabled] or [Disabled] for powering up the computer when the external modem receives a call while the computer is in Soft-off mode. Configuration options: [Disabled] [Enabled]



The computer cannot receive or transmit data until the computer and applications are fully running. Thus, connection cannot be made on the first try. Turning an external modem off and then back on while the computer is off causes an initialization string that turns the system power on.

Power On By RTC Alarm [Disabled]

Allows you to enable or disable RTC to generate a wake event. When this item is set to Enabled, the items Date of Month Alarm and Time (hh:mm:ss) Alarm items become user-configurable with set values.

Configuration options: [Disabled] [Enabled]

Date (of Month) Alarm [Disabled]

To set the date of alarm, highlight this item and press <Enter> to display the Day of Month Alarm pop-up menu. Key-in a value within the specified range then press <Enter>. Configuration options: [Min=0] [Max=31]

Time (hh:mm:ss) Alarm [Disabled]

To set the time of alarm:

1. Highlight this item and press <Enter> to display a pop-up menu for the hour field.
2. Key-in a value (Min=0, Max=23), then press <Enter>.
3. Press <TAB> to move to the minutes field then press <Enter>.
4. Key-in a minute value (Min=0, Max=59), then press <Enter>.
5. Press <TAB> to move to the seconds field then press <Enter>.
6. Key-in a value (Min=0, Max=59), then press <Enter>.

Power Up By PS/2 Mouse [Disabled]

When set to [Enabled], this parameter allows you to use the PS/2 mouse to turn on the system. This feature requires an ATX power supply that provides at least 1A on the +5VSB lead.

Configuration options: [Disabled] [Enabled]

Power On By PS/2 Keyboard [Disabled]

Allows you to disable the Power On by PS/2 keyboard function or set specific keys on the PS/2 keyboard to turn on the system. This feature requires an ATX power supply that provides at least 1A on the +5VSB lead. Configuration options: [Disabled] [Space Bar] [Ctrl-ESC] [Power Key]

2.5.4 Hardware Monitor

The items in this sub-menu displays the hardware monitor values automatically detected by the BIOS. It also allows you to change CPU Q-Fan feature-related parameters. Select an item then press <Enter> to display the configuration options.

Phoenix-Award BIOS CMOS Setup Utility		
Power		
Hardware Monitor		Select Menu
Q-Fan Controller	[Disabled]	Item Specific Help▶▶ Press [Enter] to enable or disable
Vcore Voltage	1.50V	
3.3V Voltage	3.31V	
5V Voltage	4.94V	
12V Voltage	11.26V	
CPU Temperature	48°C	
M/B Temperature	38°C	
CPU FAN Speed	4962 RPM	
PWR FAN Speed	0 RPM	
CHA FAN1 Speed	0 RPM	
CPU Fan Speed warning	[800 RPM]	

F1: Help ↑↓: Select Item -/+ : Change Value F5: Setup Defaults
ESC: Exit →←: Select Menu Enter: Select Sub-menu F10: Save and Exit

Q-Fan Controller [Disabled]

Allows you to enable or disable the ASUS Q-Fan feature.

Configuration options: [Disabled] [Enabled]

VCORE Voltage, +12V Voltage, 3.3V Voltage, 5VCC Voltage

The onboard hardware monitor automatically detects the voltage output through the onboard voltage regulators. These items can be set to ignored.

CPU Temperature, M/B Temperature

The onboard hardware monitor automatically detects and displays the motherboard and CPU temperatures. These items are not user-configurable.

CPU Fan Speed, PWR Fan Speed, CHA Fan Speed

The onboard hardware monitor automatically detects and displays the CPU, Power, and Chassis fan speeds in rotations per minute (RPM). If the fan is not connected to the motherboard, the field shows 0. These items are not user-configurable.

CPU Fan Speed warning [800 RPM]

Allows you to set the CPU fan warning speed.

Configuration options: [Disabled] [800 RPM] [1200 RPM] [1600 RPM]

2.6 Boot menu

The Boot menu items allow you to change the system boot options. Select an item then press <Enter> to display the sub-menu.

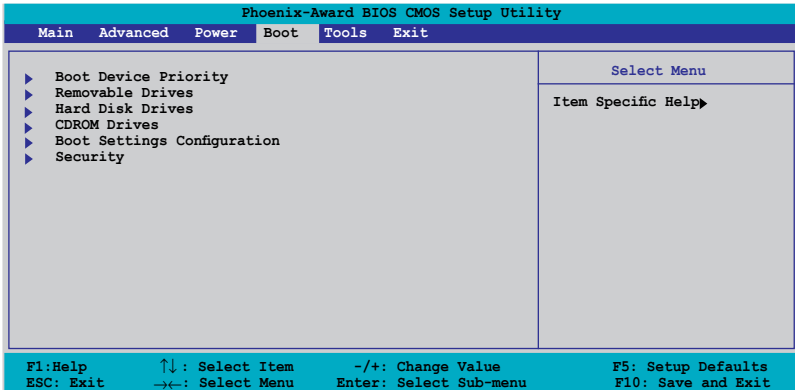

2.6.1 Boot Device Priority

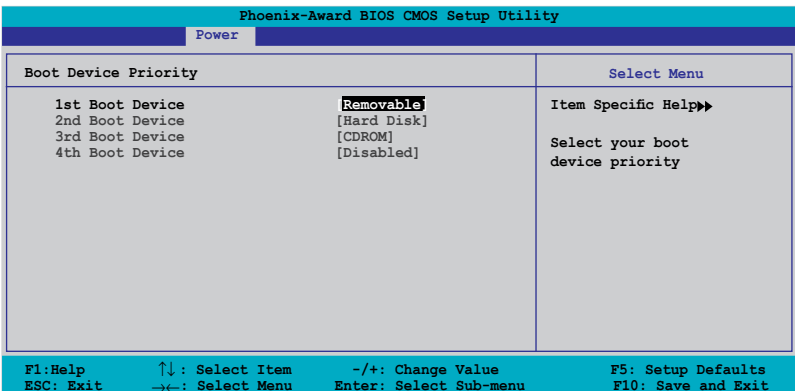

1st ~ xth Boot Device [Removable]

These items specify the boot device priority sequence from the available devices. The number of device items that appears on the screen depends on the number of devices installed in the system.

Configuration options: [Removable] [Hard Disk] [CDROM] [Legacy LAN] [Disabled]

2.6.2 Removable Drives

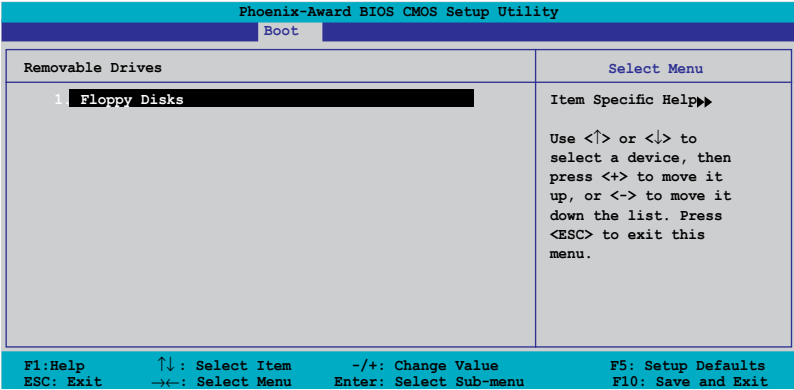

1. Floppy Disks

Allows you to assign a removable drive attached to the system.

2.6.3 Hard Disk Drives

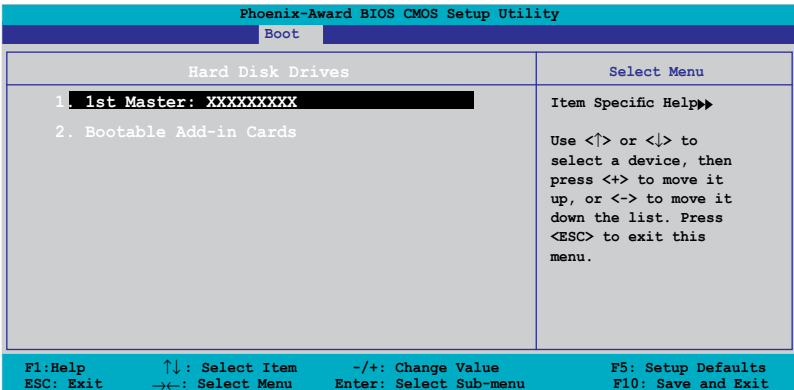

1. 1st Master: XXXXXXXXX

Allows you to assign hard disk drives attached to the system.

2.6.4 CDROM Drives

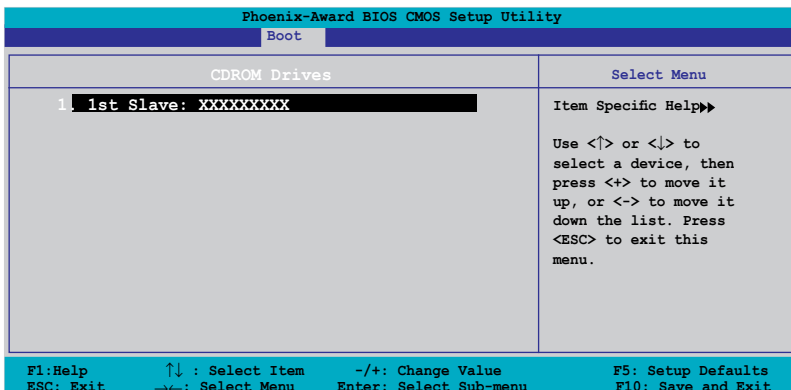

1. 1st Slave: XXXXXXXX

Allows you to assign optical drives attached to the system.

2.6.5 Boot Settings Configuration

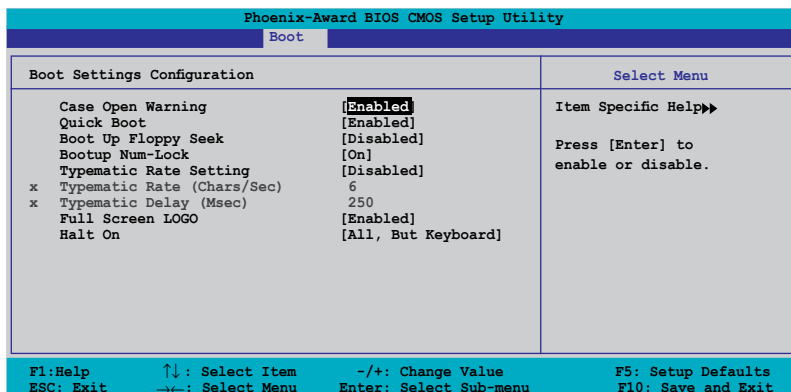

Case Open Warning [Enabled]

Enables or disables the chassis open status feature. Setting to Enabled, clears the chassis open status. Refer to section "1.10.2 Internal connectors" for setting details. Configuration options: [Disabled] [Enabled]

Quick Boot [Enabled]

Allows you to enable or disable the system quick boot feature. When Enabled, the system skips certain tests while booting. Configuration options: [Disabled] [Enabled]

Boot Up Floppy Seek [Disabled]

Enable this item to allow the BIOS to check a floppy drive during POST.
Configuration options: [Disabled] [Enabled]

Bootup Num-Lock [On]

Allows you to select the power-on state for the NumLock.
Configuration options: [Off] [On]

Typematic Rate Setting [Disabled]

Allows you to set the keystroke rate. Enable this item to configure the Typematic Rate (Chars/Sec) and the **Typematic Delay (Msec)**.
Configuration options: [Disabled] [Enabled]



The items **Typematic Rate (Chars/Sec)** and **Typematic Delay (Msec)** becomes user-configurable only when the item Typematic Rate Setting is enabled.

Typematic Rate (Chars/Sec) [6]

Allows you to select the rate at which a character repeats when you hold a key. Configuration options: [6] [8] [10] [12] [15] [20] [24] [30]

Typematic Delay (Msec) [250]

Allows you to set the delay before keystrokes begin to repeat.
Configuration options: [250] [500] [750] [1000]

Full Screen LOGO [Disabled]

Allows you to enable or disable the full screen logo display feature.
Configuration options: [Disabled] [Enabled]



Make sure that the above item is set to [Enabled] if you want to use the ASUS MyLogo2™ feature.

Halt On [All, But Keyboard]

Allows you to error report type.
Configuration options: [All Errors] [No Errors] [All, But Keyboard] [All, But Diskette] [All, But Disk/Key]

2.6.6 Security

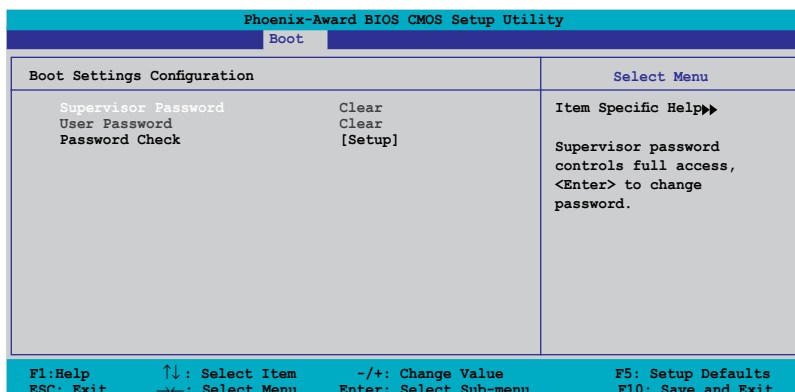

Supervisor Password User Password

These fields allow you to set passwords:

To set a password:

1. Select an item then press <Enter>.
2. Type in a password using a combination of a maximum of eight (8) alpha-numeric characters, then press <Enter>.
3. When prompted, confirm the password by typing the exact characters again, then press <Enter>. The password field setting is changed to [Set].

To clear the password:

1. Select the password field and press <Enter> twice. The following message appears:



2. Press any key to continue. The password field setting is changed to Clear.

A note about passwords

The Supervisor password is required to enter the BIOS Setup program preventing unauthorized access. The User password is required to boot the system preventing unauthorized use.

Forgot your password?

If you forget your password, you can clear it by erasing the CMOS Real Time Clock (RTC) RAM. The RAM data containing the password information is powered by the onboard button cell battery. If you need to erase the CMOS RAM, refer to section “1.9 Jumpers” for instructions.

Password Check

This field requires you to enter the password before entering the BIOS setup or the system. Select [Setup] to require the password before entering the BIOS Setup. Select [System] to require the password before entering the system.

Configuration options: [Setup] [System]

2.7 Tools menu

The Tools menu items allow you to configure options for special functions. Select an item then press <Enter> to display the sub-menu.

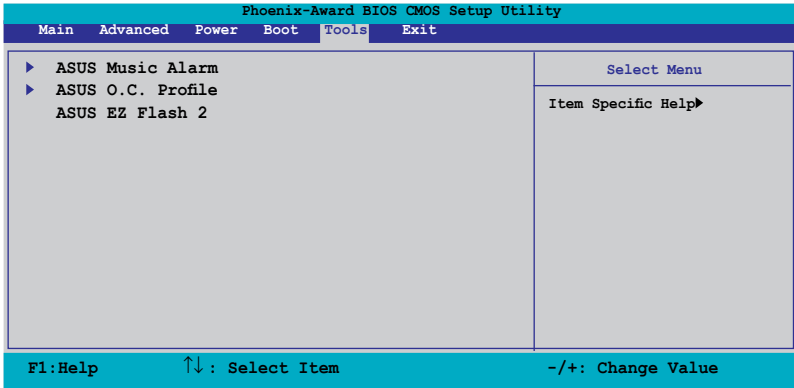

2.7.1 ASUS Music Alarm

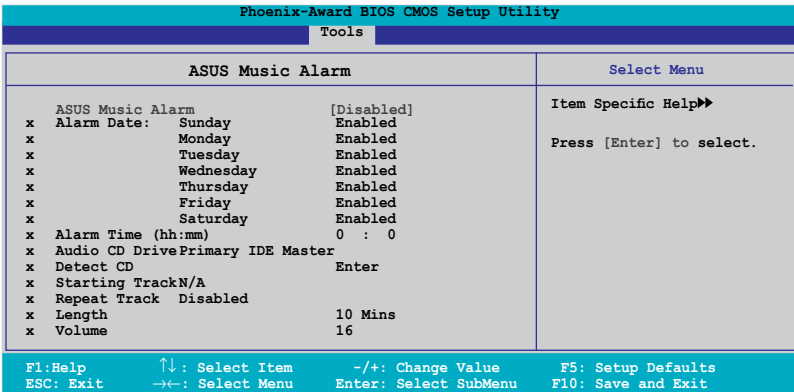

ASUS Music Alarm [Disabled]

Allows you to enable or disable the ASUS Music Alarm function. Configuration options: [Disabled] [Enabled]



The succeeding items become user-configurable when you enable the ASUS Music Alarm.

Alarm Date: Sunday/Monday/Tuesday/Wednesday/ Thursday/Friday/Saturday [Enabled]

Allows you to enable or disable the alarm for a particular day.
Configuration options: [Disabled] [Enabled]

Alarm Time (hh:mm) 0 : 0

Allows you to set the alarm time. Press <Tab> to select the field, then use <+> or <-> to change the value. Configuration options: [Disabled] [Enabled]

Audio CD Drive [Primary IDE Master]

Allows you to select the connection configuration of the optical storage device from which the alarm music will play from. Configuration options: [Primary IDE Master] [Primary IDE Slave]

Detect CD

Press <Enter> to search the CD track number.

Starting Track

Allows you to choose the starting track from the CD from which you would like the alarm music to play.

Repeat Track [Disabled]

Allows you to enable or disable the repeat track function.
Configuration options: [Disabled] [Single] [All]

Length [10 Mins]

Allows you to set the length of the music alarm.
Configuration options: [10 Mins] [20 Mins] [30 Mins] [1 Hour]

Volume [16]

Allows you to set the volume level of the music alarm.
Configuration options: [01] ~ [32]



- Only the IDE ATAPI devices from the chipset can support the Music Alarm function.
- When Music Alarm is enabled, the system needs standby power. Make sure that the power cord is plugged to a power source.
- You can also set the alarm time from the operating system using the ASUS Music Alarm utility. See section “3.3.1 ASUS Music Alarm” for details.
- ASUS Music Alarm supports audio CDs only.

2.7.2 ASUS O.C. Profile

This item allows you to store or load multiple BIOS settings.

Phoenix-Award BIOS CMOS Setup Utility	
Tools	
ASUS BIOS Profile	Select Menu
▶ Load BIOS Profile ▶ Save BIOS Profile	Item Specific Help▶ Press [Enter] to select.

Load BIOS Profile

Phoenix-Award BIOS CMOS Setup Utility	
Tools	
Load BIOS Profile	Select Menu
Load from Profile 1 Load from Profile 2 Load from File	Item Specific Help▶ Load BIOS Profile from Profile 1.

Load from Profile 1/2

Allows you to load the previous BIOS settings saved in the BIOS Flash.
Press <Enter> to load the file.

Load from File

Allows you to load the previous BIOS file saved in the hard disk, floppy disk, or USB flash disk with a FAT32/16/12 format.

To load the BIOS file:

1. Insert the storage device that contains the “xxx.CMO” BIOS profile.
2. Turn on the system.
3. Enter BIOS setup program. Go to **Tools** then select **Load from File** and press <Enter>.
4. Press <Tab> to select the drive with the BIOS profile then press <Enter> to load file.
5. Follow message screen when loading is finished.



Update only a BIOS file coming from the same memory/CPU configuration and BIOS version.

Save BIOS Profile

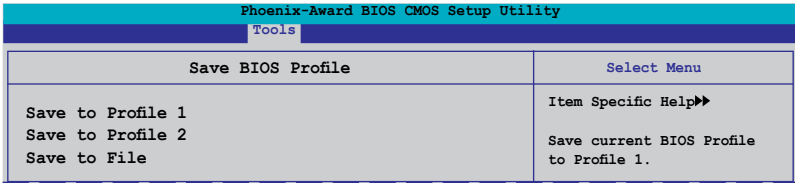

Save to Profile 1/2

Allows you to save the current BIOS file to the BIOS Flash. Press <Enter> to save the file.

Save to File

Allows you to save the current BIOS file to the hard disk, a floppy, or USB flash disk with a FAT32/16/12 format.

To save the BIOS file:

1. Insert the storage device with at least xxMB of available storage space.
2. Turn on the system.
3. Enter the BIOS setup program. Go to **Tool** then select **Save to File** and press <Enter>.
4. Press <Tab> to select the drive with the BIOS profile then press <Enter> to load file.
5. Follow message screen when loading is finished. A pop-up message will inform you when the saving process is finished.

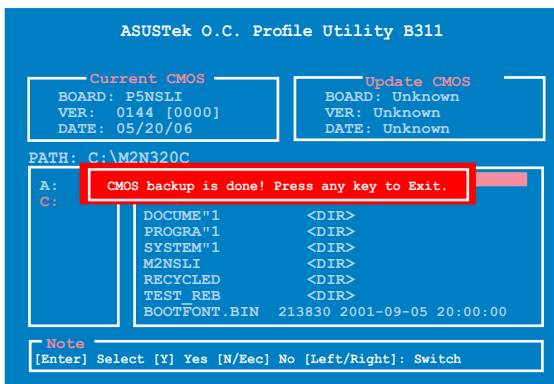

The BIOS file will be saved as “xxx.CMO”.

2.7.3 ASUS EZ Flash 2

Allows you to run ASUS EZ Flash 2. Press <Enter> to start EZ Flash 2 then from the confirmation screen, use the left or right arrows to select [Yes] or [No] then press <Enter>.

The following screen appears if you select [Yes]. Follow screen instructions to flash the BIOS.

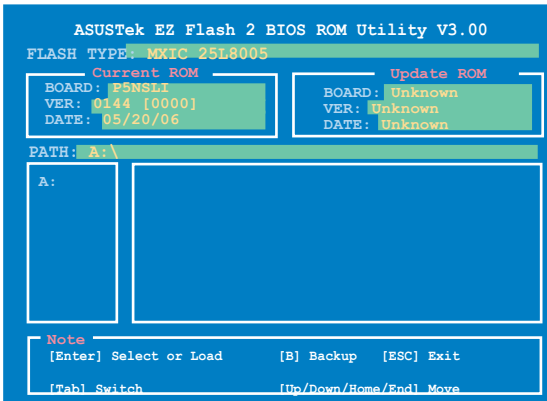

2.8 Exit menu

The Exit menu items allow you to load the optimal or failsafe default values for the BIOS items, and save or discard your changes to the BIOS items.

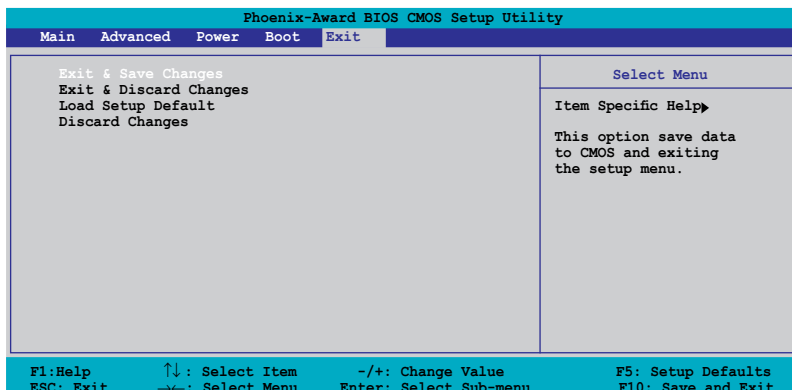

Pressing <Esc> does not immediately exit this menu. Select one of the options from this menu or <F10> from the legend bar to exit.

Exit & Save Changes

Once you are finished making your selections, choose this option from the Exit menu to ensure the values you selected are saved to the CMOS RAM. An onboard backup battery sustains the CMOS RAM so it stays on even when the PC is turned off. When you select this option, a confirmation window appears. Select **Yes** to save changes and exit.



If you attempt to exit the Setup program without saving your changes, the program prompts you with a message asking if you want to save your changes before exiting. Press <Enter> to save the changes while exiting.

Exit & Discard Changes

Select this option only if you do not want to save the changes that you made to the Setup program. If you made changes to fields other than System Date, System Time, and Password, the BIOS asks for a confirmation before exiting.

Load Setup Defaults

This option allows you to load the default values for each of the parameters on the Setup menus. When you select this option or if you press <F5>, a confirmation window appears. Select **Yes** to load default values. Select **Exit & Save Changes** or make other changes before saving the values to the non-volatile RAM.

Discard Changes

This option allows you to discard the selections you made and restore the previously saved values. After selecting this option, a confirmation appears. Select **Yes** to discard any changes and load the previously saved values.

This chapter describes the contents of the support CD that comes with the motherboard package.

Software support



3.1 Installing an operating system

This motherboard supports Windows® 2000/2003 Server/XP/64-bit XP operating systems (OS). Always install the latest OS version and corresponding updates to maximize the features of your hardware.



- Motherboard settings and hardware options vary. Use the setup procedures presented in this chapter for reference only. Refer to your OS documentation for detailed information.
- Make sure that you install Windows® 2000 Service Pack 4 or the Windows® XP Service Pack 2 or later versions before installing the drivers for better compatibility and system stability.

3.2 Support CD information

The support CD that came with the motherboard package contains the drivers, software applications, and utilities that you can install to avail all motherboard features.



The contents of the support CD are subject to change at any time without notice. Visit the ASUS website(www.asus.com) for updates.

3.2.1 Running the support CD

Place the support CD to the optical drive. The CD automatically displays the Drivers menu if Autorun is enabled in your computer.



Click an icon to display support CD/motherboard information

Click an item to install



If Autorun is NOT enabled in your computer, browse the contents of the support CD to locate the file **ASSETUP.EXE** from the BIN folder. Double-click the **ASSETUP.EXE** to run the CD.

3.2.2 Drivers menu

The drivers menu shows the available device drivers if the system detects installed devices. Install the necessary drivers to activate the devices.



ASUS InstAll-Installation Wizard for Drivers

Installs all of the drivers through ASUS InstAll-Installation wizard.

nVidia nForce Chipset Driver

Installs the NVIDIA® Chipset drivers for the NVIDIA® nForce™ 570 SLI chipset.

SoundMAX ADI1986A Audio Driver

Installs the SoundMAX® ADI1986A audio controller and application.

Marvell Yukon Gigabit Ethernet Driver

Installs the Marvell® Yukon Gigabit Ethernet driver.

USB 2.0 Driver

Installs the Universal Serial Bus 2.0 (USB 2.0) driver.

3.2.3 Utilities menu

The Utilities menu shows the applications and other software that the motherboard supports.



ASUS InstAll-Installation Wizard for Utilities

Install all of the utilities through the Installation Wizard.

Marvell Yukon VCT Application

Installs the Marvell® Yukon Virtual Cable Tester™ (VCT) application that diagnoses and reports LAN cable faults and shorts using the Time Domain Reflectometry (TDR) technology.

ASUS PC Probe II

This smart utility monitors the fan speed, CPU temperature, and system voltages, and alerts you of any detected problems. This utility helps you keep your computer in healthy operating condition.



Before using the ASUS Update, make sure that you have an Internet connection so you can connect to the ASUS website.

ASUS Music Alarm

Allows you to launch the ASUS Music alarm utility.

ADOBE Acrobat Reader V7.0

Installs the Adobe® Acrobat® Reader V7.0 that allows you to open, view, and print documents in Portable Document Format (PDF).

Microsoft DirectX 9.0c

Installs the Microsoft® DirectX 9.0c driver. The Microsoft DirectX® 9.0c is a multimedia technology that enhances computer graphics and sound. DirectX® improves the multimedia features of your computer so you can enjoy watching TV and movies, capturing videos, or playing games in your computer. Visit the Microsoft website (www.microsoft.com) for updates

Anti-virus Utility

3.2.4 Make Disk menu

The Make Disk menu contains items to create the NVIDIA® nForce™ 4 SATA RAID driver disk.



NVIDIA 32bit SATA RAID Driver

Creates the NVIDIA® 32bit driver disk for Serial ATA RAID features.

NVIDIA 64bit SATA RAID Driver

Creates the NVIDIA® 64bit driver disk for Serial ATA RAID features.

3.2.5 Manuals menu

The Manuals menu contains a list of supplementary user manuals. Click an item to open the folder of the user manual.



- Most user manual files are in Portable Document Format (PDF). Install the Adobe® Acrobat® Reader from the Utilities menu before opening a user manual file.
- Some user manuals listed in this menu may not be applicable for this motherboard model.



Nvidia RAID User's Guide

Allows you to open the Nvidia® RAID user guide.

RTL8187 Wireless LAN User's Manual

Allows you to open the Realtek® RTL8187 Wireless LAN User's Manual

3.2.6 ASUS Contact information

Click the Contact tab to display the ASUS contact information. You can also find this information on the inside front cover of this user guide.



3.3 Software information

Most of the applications in the support CD have wizards that will conveniently guide you through the installation. View the online help or readme file that came with the software application for more information.

3.3.1 ASUS Music Alarm

This motherboard is equipped with an audio alarm clock called ASUS Music Alarm. The ASUS Music Alarm gives you a personal wake-up called with your favorite CD music when the system is off. The onboard audio CODEC supports this feature, which requires an optical drive (CD-ROM, CD-RW, or DVD-ROM).



-
- Make sure that the power cord is plugged to a grounded power source so that the system has standby power.
 - ASUS Music Alarm only supports audio CDs.
 - ASUS Music Alarm will not work if you installed and enabled an add-on sound card.
 - Only IDE ATAPI devices from the Southbridge support this feature.
-

Hardware setup

To set up the hardware:

1. Connect the analog audio cable from the optical drive to the 4-pin CD-In connector labeled CD on the motherboard. See section “1.10.2 Internal connectors” for the connector location.
2. Connect speakers or a headphone to the Line-Out (lime-colored) port on the front or rear panel for audio output. You may also connect speakers or a headphone to the output jack on the optical drive.

BIOS configuration

To enable ASUS Music Alarm in the BIOS:

1. Turn on the system.
2. During POST, press to enter BIOS setup.
3. Go to the Tools menu, then select ASUS Music Alarm.
4. Set the ASUS Music Alarm item to [Enabled]. See section “2.7.1 ASUS Music Alarm” for details.

OS configuration

To configure ASUS Music Alarm in Windows®

1. Place the support CD into the optical drive.
2. Click the Utilities tab and choose ASUS Music Alarm to install the utility.
3. Insert an audio CD into the optical drive.
4. Launch the ASUS Music Alarm application by going to Start > ASUS > ASUS Music Alarm. The main window appears.



5. Click the arrow (▶) next to Time for Next Alarm in the Alarm information section. The Alarm Time Setting panel appears. Set the days and time of the alarm, or enable/disable the Music Alarm feature. When done, click OK.



6. Click the arrow (▶) next to Music in the Music section. The Music Selection panel appears. Select the optical storage device, then choose the starting CD track number from which you would like the music alarm to play. When done, click OK.



7. Click the arrow (🔍) next to Options in the Options section. The Options panel appears. Disable or select the Repeat mode, then specify the length of the alarm music to play. Set the desired volume. When done, click OK.



8. After you have finished making all the required settings, turn off the system.

Adjusting the volume

To adjust the volume while the music alarm is playing:

- Use the <Up> or <Down> arrow key to increase or decrease the volume.

Turning off the music alarm

To turn off the music alarm:



-
- While the music alarm is playing, the system wake-up features (LAN, keyboard, mouse, PCI/PCIE device, modem) are deactivated.
 - If the system loses connection or if it does not detect any optical drive or audio CD, the ASUS Music Alarm is automatically disabled/turned off.
 - While the music alarm is playing, the optical drive front panel functions are automatically disabled.
 - The ASUS Music Alarm works only when the system is off.
-

3.4 NVIDIA® SLI™ technology

The motherboard supports the NVIDIA® SLI™ (Scalable Link Interface) technology that allows you to install two identical PCI Express™ x16 graphics cards. Follow the installation procedures in this section.

3.4.1 Requirements

- You should have two identical SLI-ready graphics cards that are NVIDIA® certified.
- Visit the ASUS website (www.asus.com) for a list of qualified SLI-ready graphics cards for this motherboard.
- Make sure that your graphics card driver supports the NVIDIA SLI technology. Download the latest driver from the NVIDIA website (www.nvidia.com).
- Make sure that your power supply unit (PSU) can provide at least the minimum power required by your system. See “9. ATX power connectors” on page 1-33 for details.



-
- The NVIDIA SLI technology supports Windows® XP™ operating system only.
 - Visit the NVIDIA website for the supported 3D applications.
 - Visit the NVIDIA zone website (<http://www.nzone.com>) for the latest certified graphics card list.
-

3.4.2 Dual graphics card setup

Installing SLI-ready graphics cards



Install only identical SLI-ready graphics cards that are ASUS and NVIDIA® certified. Different types of graphics cards will not work together properly.

To install the graphics cards:

1. Prepare two graphics cards. Each graphics card should have goldfingers for the SLI connector.

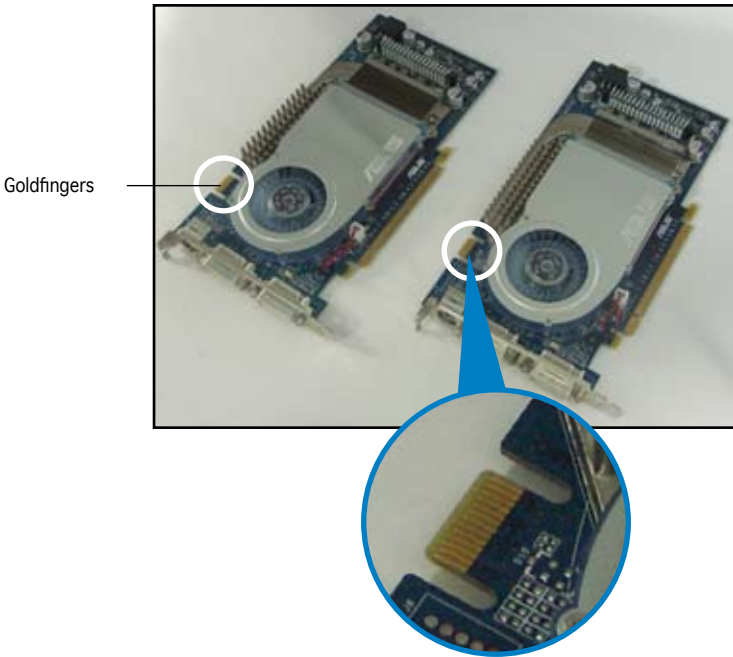

2. Remove the metal bracket covers opposite the two PCI Express x16 slots.

3. Insert one graphics card into the blue slot labeled **PCIEX16_1**. Make sure that the card is properly seated on the slot.

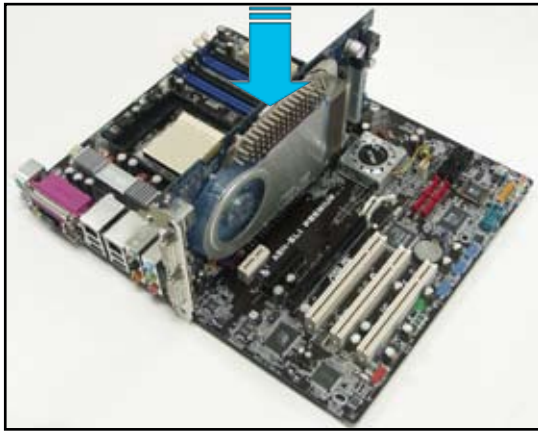

4. Insert the second graphics card into the black slot labeled **PCIEX16_2**. Make sure that the card is properly seated on the slot.



If required, connect an auxiliary power source to the PCI Express graphics cards.

5. Align and insert the SLI flexible cable connector to the goldfingers on each graphics card. Make sure that the connector is firmly in place.

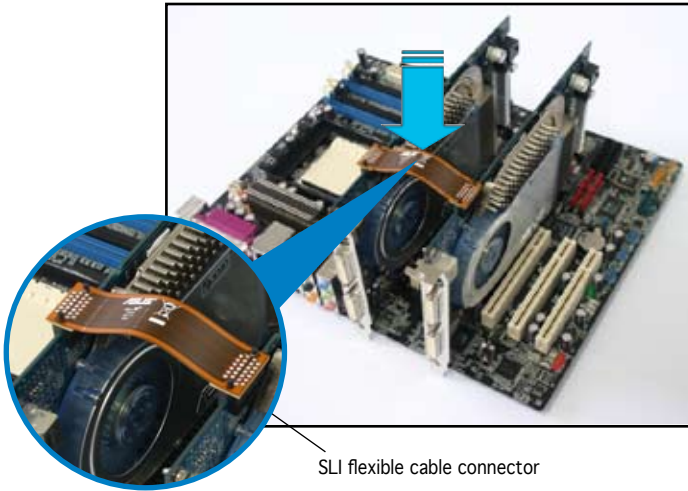

7. Connect a **VGA cable** or a **DVI-I cable** to the graphics card installed on the **blue** PCI Express slot.

Installing the device drivers

Refer to the documentation that came with your graphics card package to install the device drivers.



Make sure that your PCI Express graphics card driver supports the NVIDIA SLI technology. Download the latest driver from the NVIDIA website (www.nvidia.com).

Enabling the multi-GPU feature in Windows

After installing your graphics cards and the device drivers, enable the Multi-Graphics Processing Unit (GPU) feature in the NVIDIA nView properties.

To enable the multi-GPU feature:

1. Click the **NVIDIA Settings** icon on your Windows taskbar.



NVIDIA Settings icon

2. From the pop-up menu, select **nView Desktop Manager** then click **nView Properties**.

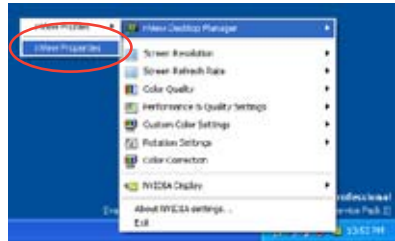

3. From the nView Desktop Manager window, select the **Desktop Management** tab.
4. Click **Properties** to display the Display Properties dialog box.



- From the Display Properties dialog box, select the **Settings** tab then click **Advanced**.



- Select the **NVIDIA GeForce** tab.



- Click the slider to display the following screen, then select the **SLI multi-GPU** item.

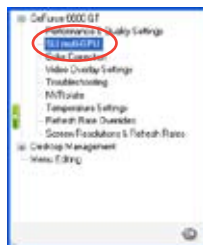

Slider



8. Click the **Enable SLI multi-GPU** check box.
9. Click **OK** when done.

Setting the ASUS AI Selector utility

From the AI Selector utility, select **Dual Video Cards** then click **Yes** to restart your system. Refer to Table 1 below for the AI Selector card settings.

Table 1 AI Selector settings

AI Selector setting		PC EX16_1 (blue) slot		PCIEX16_2 (black) slot	
		Card Type	Speed	Card Type	Speed
Single Video Card		Qualified PCIe x16 graphics card	x16	-	-
Dual Video Card	SLI mode	Qualified SLI-ready graphics cards	x8	Qualified SLI-ready graphics card	x8
	Multi-monitor, RAID or LAN setup	Qualified PCIe x16 graphics card	x8	Qualified PCIe graphics card, RAID or LAN card	x8, x4, x2, x1



When the SLI mode is disabled, the multi-monitor mode is automatically enabled. Use the NVIDIA nView utility to configure your multi-monitor setup.

The Appendix describes the CPU features that the motherboard supports.

CPU features **A**

A.1 Intel® EM64T



- The motherboard is fully compatible with Intel® Pentium® 4 LGA775 processors running on 32-bit operating systems.
 - The motherboard comes with a BIOS file that supports EM64T. You can download the latest BIOS file from the ASUS website (www.asus.com/support/download/) if you need to update the BIOS file. See Chapter 2 for details.
 - Visit www.intel.com for more information on the EM64T feature.
 - Visit www.microsoft.com for more information on Windows® 64-bit OS.
-

Using the Intel® EM64T feature

To use the Intel® EM64T feature:

1. Install an Intel® Pentium® 4 CPU that supports the Intel® EM64T.
2. Install a 64-bit operating system (Windows® XP Professional x64 Edition or Windows® Server 2003 x64 Edition).
3. Install the 64-bit drivers for the motherboard components and devices from the support CD.
4. Install the 64-bit drivers for expansion cards or add-on devices, if any.



Refer to the expansion card or add-on device(s) documentation, or visit the related website, to verify if the card/device supports a 64-bit system.

A.2 Enhanced Intel SpeedStep® Technology (EIST)



- The motherboard comes with a BIOS file that supports EIST. You can download the latest BIOS file from the ASUS website (www.asus.com/support/download/) if you need to update the BIOS. See Chapter 2 for details.
 - Visit www.intel.com for more information on the EIST feature.
-

A.2.1 System requirements

Before using EIST, check your system if it meets the following requirements:

- Intel® Pentium® 4 processor with EIST support
- BIOS file with EIST support
- Operating system with EIST support (Windows® XP SP2/Windows® Server 2003 SP1/Linux 2.6 kernel or later versions)

A.2.2 Using the EIST

To use the EIST feature:

1. Turn on the computer, then enter the BIOS Setup.
2. Go to the Advanced Menu, highlight CPU Configuration, then press <Enter>.
3. Set the Intel(R) SpeedStep Technology item to [Automatic], then press <Enter>. See page 2-28 for details.
4. Press <F10> to save your changes and exit the BIOS setup.
5. After the computer restarts, right click on a blank space on the desktop, then select Properties from the pop-up menu.
6. When the Display Properties window appears, click the Screen Saver tab.
7. Click the Power button on the Monitor power section to open the Power Options Properties window.

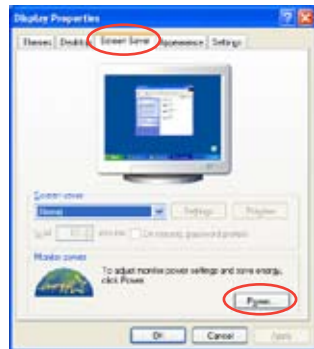

8. On the Power schemes section, click , then select any option except Home/Office Desktop or Always On.
9. Click Apply, then click OK.
10. Close the Display Properties window.

After you adjust the power scheme, the CPU internal frequency slightly decreases when the CPU loading is low.

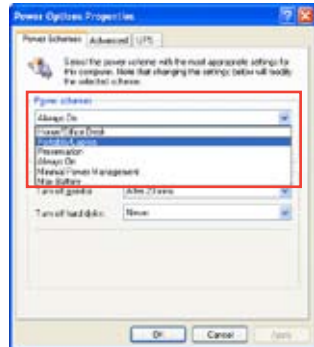

The screen displays and procedures may vary depending on the operating system.

A.3 Intel® Hyper-Threading Technology



- The motherboard supports Intel® Pentium® 4 LGA775 processors with Hyper-Threading Technology.
 - Hyper-Threading Technology is supported under Windows® XP/2003 Server and Linux 2.4.x (kernel) and later versions only. Under Linux, use the Hyper-Threading compiler to compile the code. If you are using any other operating systems, disable the Hyper-Threading Technology item in the BIOS to ensure system stability and performance.
 - Installing Windows® XP Service Pack 1 or later version is recommended.
 - Make sure to enable the Hyper-Threading Technology item in BIOS before installing a supported operating system.
 - For more information on Hyper-Threading Technology, visit www.intel.com/info/hyperthreading.
-

Using the Hyper-Threading Technology

To use the Hyper-Threading Technology:

1. Install an Intel® Pentium® 4 CPU that supports Hyper-Threading Technology.
2. Power up the system and enter the BIOS Setup. Under the Advanced Menu, make sure that the item Hyper-Threading Technology is set to Enabled.

The BIOS item appears only if you installed a CPU that supports Hyper-Threading Technology.