

Notebook PC

Hardware User's Manual

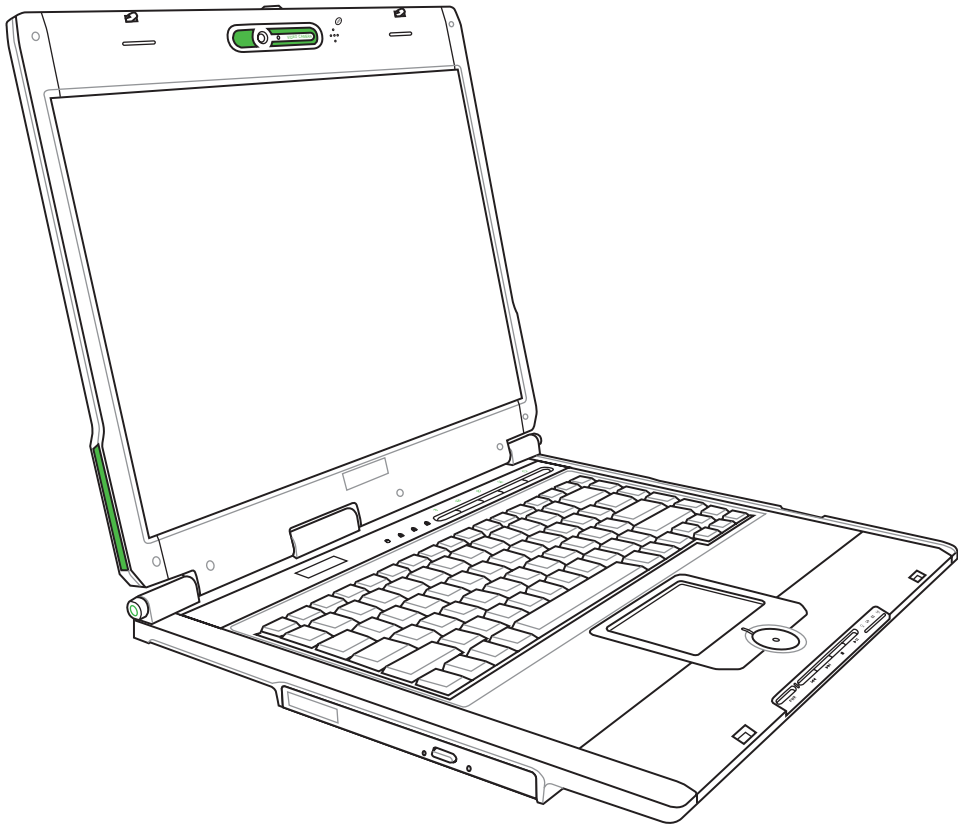

Table of Contents

1. Introducing the Notebook PC

| | |
|---------------------------------|---|
| About This User's Manual | 6 |
| Notes For This Manual..... | 6 |
| Preparing your Notebook PC..... | 9 |

2. Knowing the Parts

| | |
|------------------|----|
| Top Side..... | 12 |
| Bottom Side..... | 14 |
| Right Side..... | 16 |
| Left Side | 18 |
| Front Side..... | 19 |
| Rear Side..... | 20 |

3. Getting Started

| | |
|--------------------------------------|----|
| Power System | 24 |
| Using AC Power..... | 24 |
| Using Battery Power | 25 |
| Battery Care..... | 25 |
| Powering ON the Notebook PC | 26 |
| The Power-On Self Test (POST)..... | 26 |
| Checking Battery Power | 27 |
| Charging the Battery Pack..... | 27 |
| Power Options | 28 |
| Power Management Modes..... | 29 |
| Sleep and Hibernate | 29 |
| Thermal Power Control..... | 29 |
| Special Keyboard Functions..... | 30 |
| Colored Hot Keys..... | 30 |
| Microsoft Windows Keys..... | 32 |
| Keyboard as a Numeric Keypad | 32 |
| Keyboard as Cursors | 32 |
| Switches and Status Indicators | 33 |
| Switches..... | 33 |
| Status Indicators | 35 |

Table of Contents (Cont.)

4. Using the Notebook PC

| | |
|----------------------------------------------------------|----|
| Pointing Device..... | 40 |
| Using the Touchpad | 40 |
| Touchpad Usage Illustrations..... | 41 |
| Caring for the Touchpad..... | 42 |
| Automatic Touchpad Disabling (Synaptics)..... | 42 |
| Gaming Optical Mouse (on selected models)..... | 43 |
| Storage Devices | 45 |
| Expansion Card | 45 |
| Optical Drive | 46 |
| Flash Memory Card Reader | 48 |
| Hard Disk Drive..... | 49 |
| Memory (RAM)..... | 50 |
| Connections..... | 51 |
| Modem Connection..... | 51 |
| Network Connection | 52 |
| Wireless LAN Connection (on selected models) | 53 |
| Windows Wireless Network Connection | 54 |
| Bluetooth Wireless Connection (on selected models) | 55 |
| Trusted Platform Module (TPM) (on selected models) | 56 |

Appendix

| |
|------------------------------------|
| Optional Accessories |
| Optional Connections |
| Operating System and Software |
| Glossary |
| Declarations and Safety Statements |
| Notebook PC Information |

1. Introducing the Notebook PC

About This User's Manual

Notes For This Manual

Safety Precautions

Preparing your Notebook PC



NOTE: Photos and icons in this manual are used for artistic purposes only and do not show what is actually used in the product itself.

About This User's Manual



You are reading the Notebook PC User's Manual. This User's Manual provides information on the various components in the Notebook PC and how to use them. The following are major sections of this User's Manuals:

- 1. Introducing the Notebook PC**
Introduces you to the Notebook PC and this User's Manual.
- 2. Knowing the Parts**
Gives you information on the Notebook PC's components.
- 3. Getting Started**
Gives you information on getting started with the Notebook PC.
- 4. Using the Notebook PC**
Gives you information on using the Notebook PC's components.
- 5. Appendix**
Introduces you to optional accessories and gives additional information.

Notes For This Manual

A few notes and warnings in bold are used throughout this guide that you should be aware of in order to complete certain tasks safely and completely. These notes have different degrees of importance as described below:



NOTE: Tips and information for special situations.



TIP: Tips and useful information for completing tasks.



IMPORTANT! Vital information that must be followed to prevent damage to data, components, or persons.



WARNING! Important information that must be followed for safe operation.

<> Text enclosed in <> or [] represents a key on the keyboard; do not actually type the [] <> or [] and the enclosed letters.

Safety Precautions

The following safety precautions will increase the life of the Notebook PC. Follow all precautions and instructions. Except as described in this manual, refer all servicing to qualified personnel. Do not use damaged power cords, accessories, or other peripherals. Do not use strong solvents such as thinners, benzene, or other chemicals on or near the surface.



IMPORTANT! Disconnect the AC power and remove the battery pack(s) before cleaning. Wipe the Notebook PC using a clean cellulose sponge or chamois cloth dampened with a solution of nonabrasive detergent and a few drops of warm water and remove any extra moisture with a dry cloth.



DO NOT place on uneven or unstable work surfaces. Seek servicing if the casing has been damaged.



DO NOT place or drop objects on top and do not shove any foreign objects into the Notebook PC.



DO NOT press or touch the display panel. Do not place together with small items that may scratch or enter the Notebook PC.



DO NOT expose to strong magnetic or electrical fields.



DO NOT expose to dirty or dusty environments. **DO NOT** operate during a gas leak.



DO NOT expose to or use near liquids, rain, or moisture. **DO NOT** use the modem during an electrical storm.



DO NOT leave the Notebook PC on your lap or any part of the body in order to prevent discomfort or injury from heat exposure.



Battery safety warning:
DO NOT throw the battery in fire.
DO NOT short circuit the contacts.
DO NOT disassemble the battery.



SAFE TEMP: This Notebook PC should only be used in environments with ambient temperatures between 5°C (41°F) and 35°C (95°F)



INPUT RATING: Refer to the rating label on the bottom of the Notebook PC and be sure that your power adapter complies with the rating.



DO NOT throw the Notebook PC in municipal waste. Check local regulations for disposal of electronic products.



DO NOT carry or cover a Notebook PC that is powered ON with any materials that will reduce air circulation such as a carrying bag.

1 Introducing the Notebook PC

Transportation Precautions

To prepare the Notebook PC for transport, you should turn it OFF and **disconnect all external peripherals to prevent damage to the connectors**. The hard disk drive's head retracts when the power is turned OFF to prevent scratching of the hard disk surface during transport. Therefore, you should not transport the Notebook PC while the power is still ON. Close the display panel and check that it is latched securely in the closed position to protect the keyboard and display panel.



CAUTION: The Notebook PC's surface is easily dulled if not properly cared for. Be careful not to rub or scrape the Notebook PC surfaces.



Cover Your Notebook PC

Purchase a carrying bag to protect the Notebook PC from dirt, water, shock, and scratches.



Charge Your Batteries

If you intend to use battery power, be sure to fully charge your battery pack and any optional battery packs before going on long trips. Remember that the power adapter charges the battery pack as long as it is plugged into the computer and an AC power source. Be aware that it takes much longer to charge the battery pack when the Notebook PC is in use.



Airplane Precautions

Contact your airline if you want to use the Notebook PC on the airplane. Most airlines will have restrictions for using electronic devices. Most airlines will allow electronic use only between and not during takeoffs and landings.



CAUTION! There are three main types of airport security devices: X-ray machines (used on items placed on conveyor belts), magnetic detectors (used on people walking through security checks), and magnetic wands (hand-held devices used on people or individual items). You can send your Notebook PC and diskettes through airport X-ray machines. However, it is recommended that you do not send your Notebook PC or diskettes through airport magnetic detectors or expose them to magnetic wands.

Preparing your Notebook PC

These are only quick instructions for using your Notebook PC. Read the later pages for detailed information on using your Notebook PC.

1. Install the battery pack

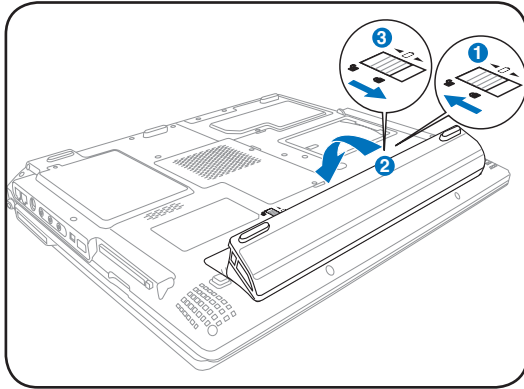

2. Connect the AC Power Adapter

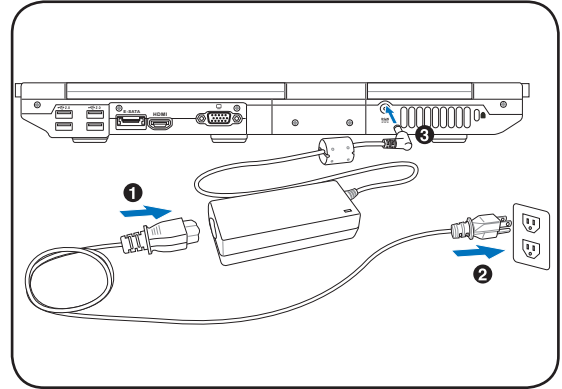

3. Open the Display Panel

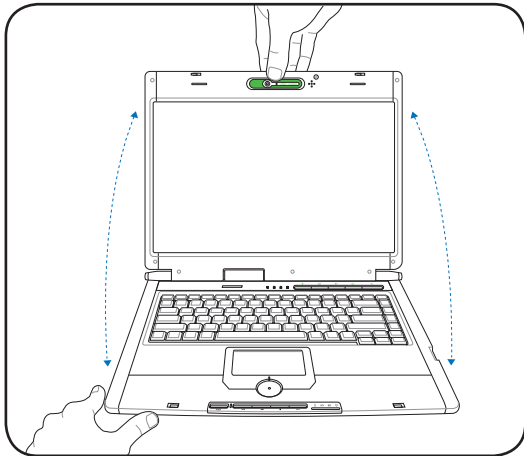

4. Turn ON the Notebook PC

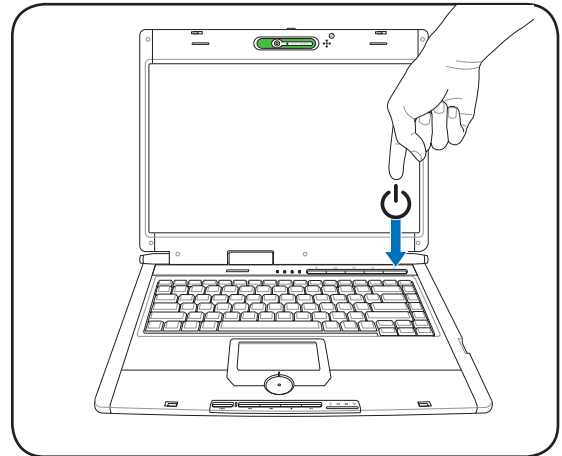

IMPORTANT! When opening, do not force the display panel down to the table or else the hinges may break! Never lift the Notebook PC by the display panel!

The power switch turns ON and OFF the Notebook PC or putting the Notebook PC into sleep or hibernation modes. Actual behavior of the power switch can be customized in Windows Control Panel > Power Options > System Settings.

2. Knowing the Parts

Basic sides of the Notebook PC



NOTE: Photos and icons in this manual are used for artistic purposes only and do not show what is actually used in the product itself.

2 Knowing the Parts

Top Side

Refer to the diagram below to identify the components on this side of the Notebook PC.



NOTE: The keyboard will be different for each territory.

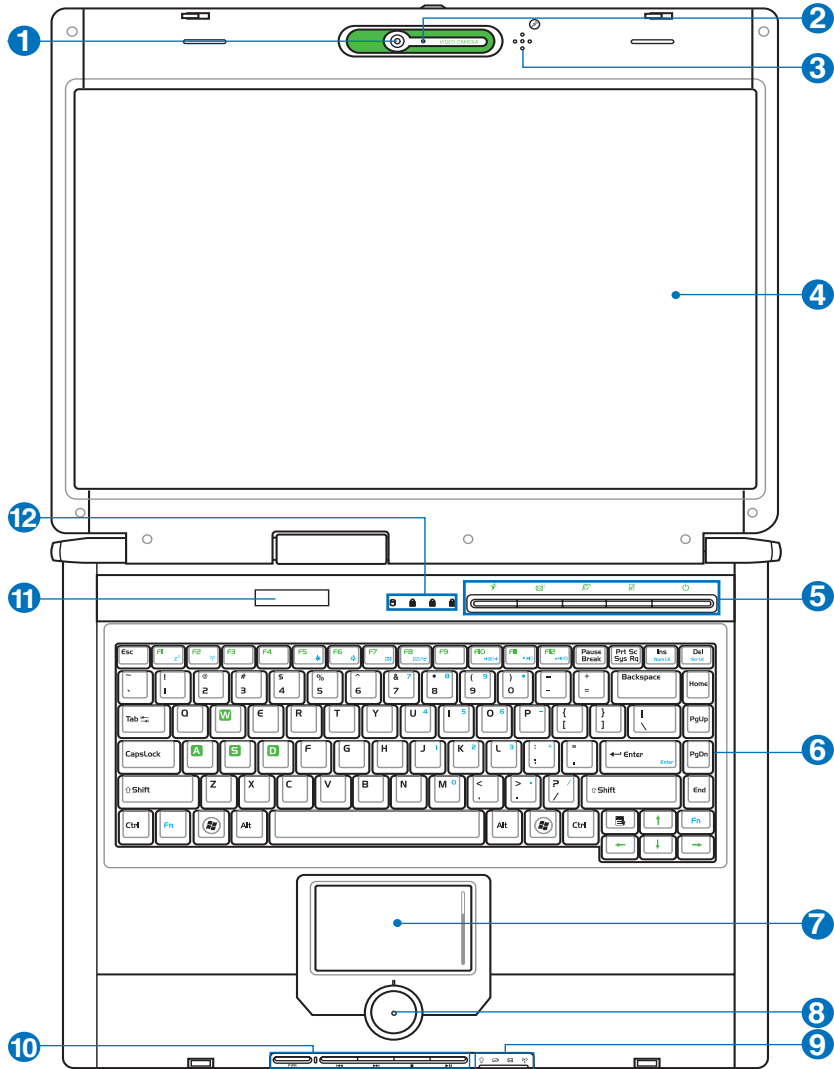



1 Camera (on selected models)



The built-in camera allows picture taking or video recording. Can be used with video conferencing and other interactive applications.





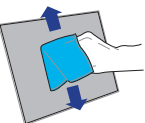

2  **Camera Indicator**
 The camera indicator shows when the built-in camera is in use. The camera may be auto-activated by supported software. 

3  **Microphone (Built-in)**
 The built-in mono microphone can be used for video conferencing, voice narrations, or simple audio recordings. 



4  **Display Panel**
 The display panel functions the same as a desktop monitor. The Notebook PC uses an active matrix TFT LCD, which provides excellent viewing like that of desktop monitors. Unlike desktop monitors, the LCD panel does not produce any radiation or flickering, so it is easier on the eyes. Use a soft cloth without chemical liquids (use plain water if necessary) to clean the display panel. 



5  **Instant Keys**
 Instant keys allow you to launch frequently used applications with one push of a button. Details are described in section 3. 



6  **Keyboard**
 The keyboard provides full-sized keys with comfortable travel (depth at which the keys can be depressed) and palm rest for both hands. Two Windows function keys are provided to help ease navigation in the Windows operating system. 



7  **Touchpad and Buttons**
 The touchpad with its buttons is a pointing device that provides the same functions as a desktop mouse. A software-controlled scrolling function is available after setting up the included touchpad utility to allow easy Windows or web navigation. 

8  **Pad-Lock Indicator (between touchpad buttons)**
 This indicator will light when the built-in touchpad is UNLOCKED (enabled). When the built-in touchpad is LOCKED (disabled), this indicator will not light. 

9  **Status Indicators (front)**
 Status indicators represent various hardware/software conditions. See indicator details in section 3. 

10  **Multimedia Control Buttons (on selected models)**
 The multimedia control buttons allows for convenient controlling of the multimedia application. (See section 3 for more information). 

11  **Direct Messenger**
 Direct console allows user-defined status indications. See indicator details in section 3. 

12  **Status Indicators (top)**
 Status indicators represent various hardware/software conditions. See indicator details in section 3. 

2 Knowing the Parts

Bottom Side

Refer to the diagram below to identify the components on this side of the Notebook PC.



NOTE: The bottom side may vary in appearance depending on model.



NOTE: The battery pack size will vary depending on model.

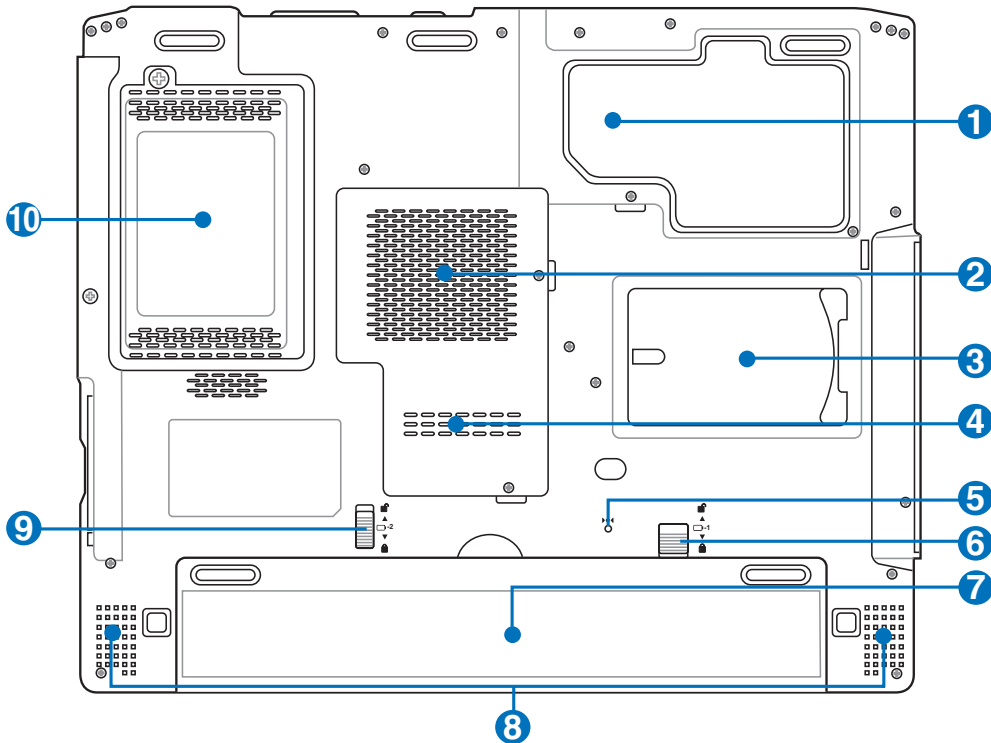

WARNING! The bottom of the Notebook PC can get very hot. Be careful when handling the Notebook PC while it is in operation or recently been in operation. High temperatures are normal during charging or operation. Do not use on soft surfaces such as beds or sofas which may block the vents. **DO NOT PUT THE NOTEBOOK PC ON YOUR LAP OR OTHER PARTS OF THE BODY TO AVOID INJURY FROM THE HEAT.**

1



Central Processor Unit (CPU) Compartment

Some Notebook PC models feature a socketed-processor design to allow upgrading to faster processors in the future. Some models feature a ULV design for compactness and may not be upgraded. Visit an authorized service center or retailer for information on upgrades.

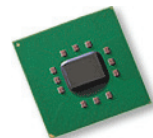

WARNING! End-user removal of the CPU or hard disk drive will void the warranty.

2  **Memory (RAM) Compartment**

The memory compartment provides expansion capabilities for additional memory. Additional memory will increase application performance by decreasing hard disk access. The BIOS automatically detects the amount of memory in the system and configures accordingly. There is no hardware or software (including BIOS) setup required after the memory is installed. Visit an authorized service center or retailer for information on memory upgrades for your Notebook PC. Only purchase expansion modules from authorized retailers of this Notebook PC to ensure maximum compatibility and reliability.



3  **Name Card Holder**

The Notebook PC has a name card holder glued to the bottom of the Notebook PC to hold identification information on the user in case the Notebook PC is found by others.



4  **Wireless LAN (WLAN) Compartment**

The WLAN compartment allows the installation of a wireless networking card in order to wirelessly connect to network access points or other wireless networking devices.



5  **Shutdown Button (Emergency)**

In case your operating system cannot properly turn OFF or restart, the shutdown button can be pressed with a straightened paper clip to shutdown the Notebook PC.



6  **Battery Lock - Manual**

The manual battery lock is used to keep the battery pack secured. Move the manual lock to the unlocked position to insert or remove the battery pack. Move the manual lock to the locked position after inserting the battery pack.



7  **Battery Pack**

The battery pack is automatically charged when the Notebook PC is connected to an AC power source and maintains power to the Notebook PC when AC power is not connected. This allows use when moving temporarily between locations. Battery time varies by usage and by the specifications for this Notebook PC. The battery pack cannot be disassembled and must be purchased as a single unit.



8  **Audio Speakers**

The built-in stereo speaker system allows you to hear audio without additional attachments. The multimedia sound system features an integrated digital audio controller that produces rich, vibrant sound. Audio features are software controlled.



9  **Battery Lock - Spring**

The spring battery lock is used to keep the battery pack secured. When the battery pack is inserted, it will automatically lock. To remove the battery pack, this spring lock must be held in the unlocked position.



10  **Hard Disk Drive Compartment**

The hard disk drive is secured in a compartment. Visit an authorized service center or retailer for information on hard disk drive upgrades for your Notebook PC. Only purchase hard disk drives from authorized retailers of this Notebook PC to ensure maximum compatibility and reliability.



2 Knowing the Parts

Right Side

Refer to the diagram below to identify the components on this side of the Notebook PC.

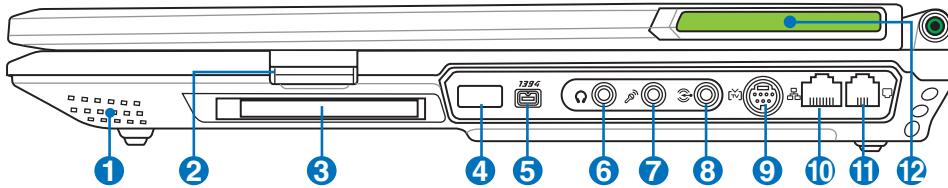

1 Audio Speaker

The built-in stereo speaker system allows you to hear audio without additional attachments. The multimedia sound system features an integrated digital audio controller that produces rich, vibrant sound (results improved with external stereo headphones or speakers). Audio features are software controlled.



2 Flash Memory Slot

Normally an external memory card reader must be purchased separately in order to use memory cards from devices such as digital cameras, MP3 players, mobile phones, and PDAs. This Notebook PC has a built-in high-speed memory card reader that can conveniently read from and write to many flash memory cards as mentioned later in this manual.



3 ExpressCard Slot

One 26pin Express card slot is available to support one ExpressCard/34mm or one ExpressCard/54mm expansion card. This new interface is faster by using a serial bus supporting USB 2.0 and PCI Express instead of the slower parallel bus used in the PC card slot. (Not compatible with previous PCMCIA cards.)



4 Infrared Port (IrDA) (on selected models)

The infrared (IrDA) communication port allows convenient wireless data communication with infrared-equipped devices or computers. This allows easy wireless synchronization with PDAs or mobile phones and even wireless printing to printers. If your office supports IrDA networking, you can have wireless connection to a network anywhere provided there is a direct line of sight to an IrDA node. Small offices can use IrDA technology to share a printer between several closely placed Notebook PCs and even send files to each other without a network.



5 ¹³⁹⁴ IEEE1394 Port (on selected models)

IEEE1394 is a high speed serial bus like SCSI but has simple connections and hot-plugging capabilities like USB. The interface IEEE1394 has a bandwidth of 100-400 Mbits/sec and can handle up to 63 units on the same bus. IEEE1394 is also used in high-end digital equipment and should be marked “DV” for Digital Video port.



6 **SPDIF Output Jack**

Combo

This jack provides connection to SPDIF (Sony/Philips Digital Interface) compliant devices for digital audio output. Use this feature to turn the Notebook PC into a hi-fi home entertainment system.



Headphone Output Jack

The stereo headphone jack (1/8 inch) is used to connect the Notebook PC's audio out signal to amplified speakers or headphones. Using this jack automatically disables the built-in speakers.



7 **Microphone Input Jack**

The mono microphone jack (1/8 inch) can be used to connect an external microphone or output signals from audio devices. Using this jack automatically disables the built-in microphone. Use this feature for video conferencing, voice narrations, or simple audio recordings.



8 **Audio Input Jack**

The stereo input jack (1/8 inch) can be used to connect a stereo audio source to the Notebook PC. This feature is used mainly to add audio to multimedia applications.



9 **TV-Out Port**

The TV-Out port is an S-Video connector that allows routing the Notebook PC's display to a television or video projection device. You can choose between simultaneously or single display. Use an S-Video cable (not provided) for high quality displays or use the provided RCA to S-Video adapter for standard video devices. This port supports both NTSC and PAL formats.



10 **LAN Port**

The RJ-45 LAN port with eight pins is larger than the RJ-11 modem port and supports a standard Ethernet cable for connection to a local network. The built-in connector allows convenient use without additional adapters.

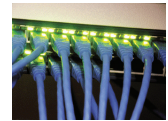

11 **Modem Port**

The RJ-11 modem port with two pins is smaller than the RJ-45 LAN port and supports a standard telephone cable. The internal modem supports up to 56K V.90 transfers. The built-in connector allows convenient use without additional adapters.



IMPORTANT! The built-in modem does not support the voltage used in digital phone systems. Do not connect the modem port to a digital phone system or else damage will occur to the Notebook PC.



12 **Direct Flash Indicator**

The direct flash indicator blinks when Microsoft DirectX 9/10 (used with most games) is running. Use the provided Direct Console software (see indicators) to enable or disable this function.



2 Knowing the Parts

Left Side

Refer to the diagram below to identify the components on this side of the Notebook PC.

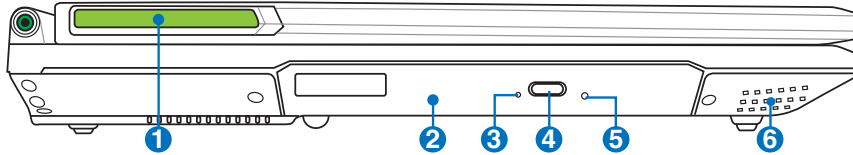

1 Direct Flash Indicator

The direct flash indicator blinks when Microsoft DirectX 9/10 (used with most games) is running. Use the provided Direct Console software (see indicators) to enable or disable this function.



2 Optical Drive

The Notebook PC comes in various models with different optical drives. The Notebook PC's optical drive may support compact discs (CD) and/or digital video discs (DVD) and may have recordable (R) or re-writable (RW) capabilities. See the marketing specifications for details on each model.



3 Optical Drive Activity Indicator (location varies by model)

The optical drive activity indicator shows when data is being transferred by the optical disk drive. This indicator will light in proportion to the data size transferred.



4 Optical Drive Electronic Eject

The optical drive eject has an electronic eject button for opening the tray. You can also eject the optical drive tray through any software player or by right clicking the optical drive in Windows "Computer" and selecting **Eject**.

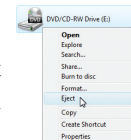

5 Optical Drive Emergency Eject (location varies by model)

The emergency eject is used to eject the optical drive tray in case the electronic eject does not work. Do not use the emergency eject in place of the electronic eject.



6 Audio Speaker

The built-in stereo speaker system allows you to hear audio without additional attachments. The multimedia sound system features an integrated digital audio controller that produces rich, vibrant sound (results improved with external stereo headphones or speakers). Audio features are software controlled.



Front Side

Refer to the diagram below to identify the components on this side of the Notebook PC.

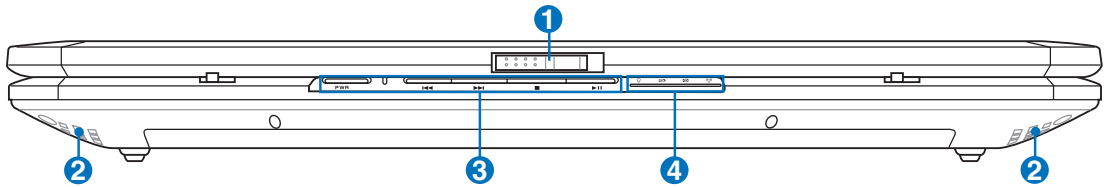

1 Display Panel Latch

One spring-loaded latch on the front of the Notebook PC locks the display panel in the closed position when the Notebook PC is not in use. To open the display panel, negotiate the latch with your thumb and lift up the display panel while holding the latch. Slowly tilt the display panel forward or backward to a comfortable viewing angle.



WARNING! When opening, do not force the display panel down to the table or else the hinges may break! Never lift the Notebook PC by the display panel!

2 Audio Speakers

The built-in stereo speaker system allows you to hear audio without additional attachments. The multimedia sound system features an integrated digital audio controller that produces rich, vibrant sound (results improved with external stereo headphones or speakers). Audio features are software controlled.



3 Multimedia Keys

Multimedia keys allow you to activate frequently used multimedia commands with one push of a button. Details are described in section 3.



4 Status Indicators (front)

Status indicators represent various hardware/software conditions. See indicator details in section 3.



2 Knowing the Parts

Rear Side

Refer to the diagram below to identify the components on this side of the Notebook PC.

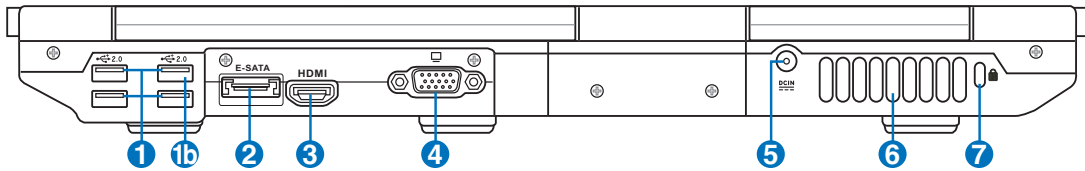

1 **USB Port (2.0/1.1) (on selected models)**

The USB (Universal Serial Bus) port is compatible with USB 2.0 or USB 1.1 devices such as keyboards, pointing devices, cameras, hard disk drives, printers, and scanners connected in a series up to 12Mbps/sec (USB 1.1) and 480Mbps/sec (USB 2.0). USB allows many devices to run simultaneously on a single computer, with some peripherals acting as additional plug-in sites or hubs. USB supports hot-swapping of devices so that most peripherals can be connected or disconnected without restarting the computer.



1b **USB Power Port**

The USB power port is a standard USB port but continues to supply 5 volt power when the Notebook PC is turned OFF with the AC power adapter connected. This allows portable devices with USB charging function to continue charging when the Notebook PC is turned OFF.

2 **E-SATA Port (on selected models)**

External SATA or eSATA allows external connection of Serial-ATA devices originally designed for use inside the computer. It is up to six times faster than existing USB 2.0, & 1394 for external storage solutions and is also hot pluggable using shielded cables and connectors up to two meters.



3 **HDMI HDMI Port**

HDMI (High-Definition Multimedia Interface) is an uncompressed all-digital audio/video interface between any audio/video source, such as a set-top box, DVD player, and A/V receiver and an audio and/or video monitor, such as a digital television (DTV). Supports standard, enhanced, or high-definition video, plus multi-channel digital audio on a single cable. It transmits all ATSC HDTV standards and supports 8-channel digital audio, with bandwidth to spare to accommodate future enhancements or requirements.

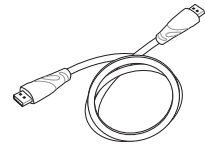

4 **Display (Monitor) Output**

The 15-pin D-sub monitor port supports a standard VGA-compatible device such as a monitor or projector to allow viewing on a larger external display.



5 **DCIN** **Power (DC) Input**

The supplied power adapter converts AC power to DC power for use with this jack. Power supplied through this jack supplies power to the Notebook PC and charges the internal battery pack. To prevent damage to the Notebook PC and battery pack, always use the supplied power adapter. **CAUTION: MAY BECOME WARM TO HOT WHEN IN USE. BE SURE NOT TO COVER THE ADAPTER AND KEEP IT AWAY FROM YOUR BODY.**



6 **Cooling Fan**

The cooling fan removes excess heat depending on temperature threshold settings.



IMPORTANT! Make sure that paper, books, clothing, cables, or other objects do not block any of the air vents or else overheating may occur.



7 **Kensington® Lock Port**

The Kensington® lock port allows the Notebook PC to be secured using Kensington® compatible Notebook PC security products. These security products usually include a metal cable and lock that prevent the Notebook PC to be removed from a fixed object. Some may also include a motion detector to sound an alarm when moved.



3. Getting Started

Using AC Power

Using Battery Power

Powering ON the Notebook PC

Checking Battery Power

Powering Options

Power Management Modes

Special Keyboard Functions

Switches and Status Indicators



NOTE: Photos and icons in this manual are used for artistic purposes only and do not show what is actually used in the product itself.

3 Getting Started

Power System



Using AC Power

The Notebook PC power is comprised of two parts, the power adapter and the battery power system. The power adapter converts AC power from a wall outlet to the DC power required by the Notebook PC. Your Notebook PC comes with a universal AC-DC adapter. That means that you may connect the power cord to any 100V-120V as well as 220V-240V outlets without setting switches or using power converters. Different countries may require that an adapter be used to connect the provided US-standard AC power cord to a different standard. Most hotels will provide universal outlets to support different power cords as well as voltages. It is always best to ask an experienced traveler about AC outlet voltages when bringing power adapters to another country.

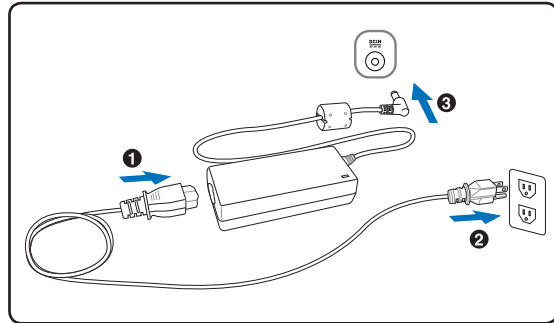

TIP: You can buy travel kits for the Notebook PC that includes power and modem adapters for almost every country.

With the AC power cord connected to the AC-DC converter, connect the AC power cord to an AC outlet (preferably with surge-protection) and then connect the DC plug to the Notebook PC. Connecting the AC-DC adapter to the AC outlet first allows you to test the AC outlet's power and the AC-DC converter itself for compatibility problems before connecting the DC power to the Notebook PC. The power indicator on the adapter (if available) will light if the power is within accepted ranges.



IMPORTANT! Damage may occur if you use a different adapter to power the Notebook PC or use the Notebook PC's adapter to power other electrical devices. If there is smoke, burning scent, or extreme heat coming from the AC-DC adapter, seek servicing. Seek servicing if you suspect a faulty AC-DC adapter. You may damage both your battery pack(s) and the Notebook PC with a faulty AC-DC adapter.



NOTE: This Notebook PC may come with either a two or three-prong plug depending on territory. If a three-prong plug is provided, you must use a grounded AC outlet or use a properly grounded adapter to ensure safe operation of the Notebook PC.



WARNING! THE POWER ADAPTER MAY BECOME WARM TO HOT WHEN IN USE. BE SURE NOT TO COVER THE ADAPTER AND KEEP IT AWAY FROM YOUR BODY.



Using Battery Power

The Notebook PC is designed to work with a removable battery pack. The battery pack consists of a set of battery cells housed together. A fully charged pack will provide several hours of battery life, which can be further extended by using power management features through the BIOS setup. Additional battery packs are optional and can be purchased separately through a Notebook PC retailer.



Installing and Removing the Battery Pack

Your Notebook PC may or may not have its battery pack installed. If your Notebook PC does not have its battery pack installed, use the following procedures to install the battery pack.



IMPORTANT! Never attempt to remove the battery pack while the Notebook PC is turned ON, as this may result in the loss of working data.

To install the battery pack:

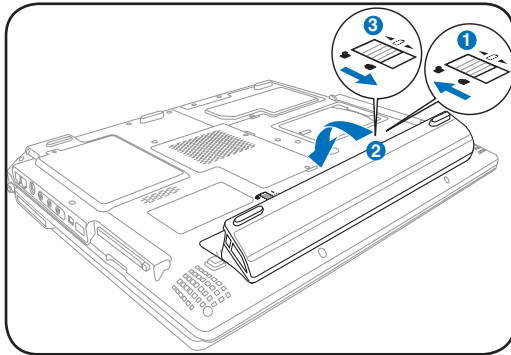

To remove the battery pack:

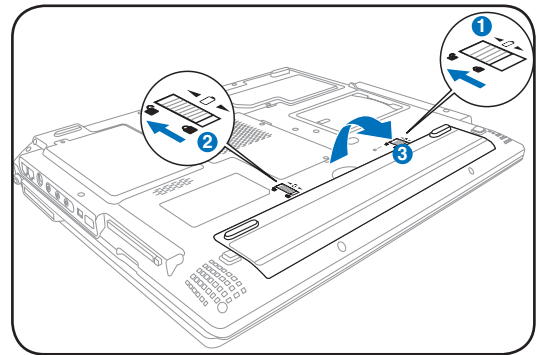

IMPORTANT! Only use battery packs and power adapters supplied with this Notebook PC or specifically approved by the manufacturer or retailer for use with this model or else damage may occur to the Notebook PC.



Battery Care

The Notebook PC's battery pack, like all rechargeable batteries, has a limit on the number times it can be recharged. The battery pack's useful life will depend on your environment temperature, humidity, and how your Notebook PC is used. It is ideal that the battery be used in a temperature range between 5°C and 35°C (41°F and 95°F). You must also take into account that the Notebook PC's internal temperature is higher than the outside temperature. Any temperatures above or below this range will shorten the life of the battery. But in any case, the battery pack's usage time will eventually decrease and a new battery pack must be purchased from an authorized dealer for this Notebook PC. Because batteries also have a shelf life, it is not recommended to buy extras for storing.



WARNING! For safety reasons, **DO NOT** throw the battery in fire, **DO NOT** short circuit the contacts, and **DO NOT** disassemble the battery. If there is any abnormal operation or damage to the battery pack caused by impact, turn **OFF** the Notebook PC and contact an authorized service center.



3 Getting Started

Powering ON the Notebook PC

The Notebook PC's power-ON message appears on the screen when you turn it ON. If necessary, you may adjust the brightness by using the hot keys. If you need to run the BIOS Setup to set or modify the system configuration, press [F2] upon bootup to enter the BIOS Setup. If you press [Tab] during the splash screen, standard boot information such as the BIOS version can be seen. Press [ESC] and you will be presented with a boot menu with selections to boot from your available drives.



NOTE: Before bootup, the display panel flashes when the power is turned ON. This is part of the Notebook PC's test routine and is not a problem with the display.



IMPORTANT! To protect the hard disk drive, always wait at least 5 seconds after turning OFF your Notebook PC before turning it back ON.



WARNING! DO NOT carry or cover a Notebook PC that is powered ON with any materials that will reduce air circulation such as a carrying bag.



The Power-On Self Test (POST)

When you turn ON the Notebook PC, it will first run through a series of software-controlled diagnostic tests called the Power-On Self Test (POST). The software that controls the POST is installed as a permanent part of the Notebook PC's architecture. The POST includes a record of the Notebook PC's hardware configuration, which is used to make a diagnostic check of the system. This record is created by using the BIOS Setup program. If the POST discovers a difference between the record and the existing hardware, it will display a message on the screen prompting you to correct the conflict by running BIOS Setup. In most cases the record should be correct when you receive the Notebook PC. When the test is finished, you may get a message reporting "No operating system found" if the hard disk was not preloaded with an operating system. This indicates that the hard disk is correctly detected and ready for the installation of a new operating system.



Self Monitoring and Reporting Technology

The S.M.A.R.T. (Self Monitoring and Reporting Technology) checks the hard disk drive during POST and gives a warning message if the hard disk drive requires servicing. If any critical hard disk drive warning is given during bootup, backup your data immediately and run Windows disk checking program. To run Windows's disk checking program: click **Start** > select **Computer** > right-click a hard disk drive icon > choose **Properties** > click the **Tools** tab > click **Check Now** > click **Start**. You can also select "Scan ... sectors" for more effective scan and repair but the process will run slower.

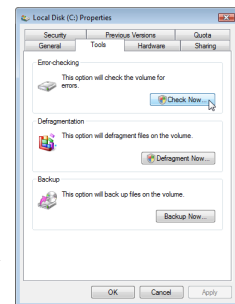

IMPORTANT! If warnings are still given during bootup after running a software disk checking utility, you should take your Notebook PC in for servicing. Continued use may result in data loss.

Checking Battery Power

The battery system implements the Smart Battery standard under the Windows environment, which allows the battery to accurately report the amount of charge left in the battery. A fully-charged battery pack provides the Notebook PC a few hours of working power. But the actual figure varies depending on how you use the power saving features, your general work habits, the CPU, system memory size, and the size of the display panel.



Note: Screen captures shown here are examples only and may not reflect what you see in your system.

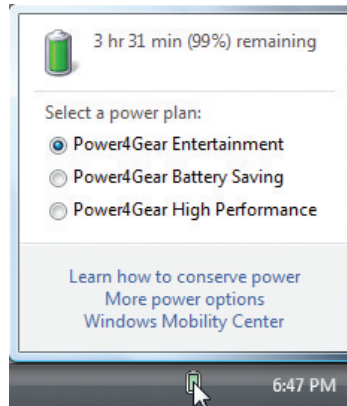

Left-click the battery icon

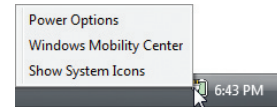

Right-click the battery icon

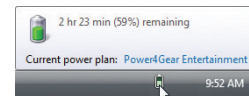

Cursor over the battery icon without power adapter.

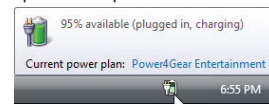

Cursor over the battery icon with power adapter.



NOTE: You will be warned when battery power is low. If you continue to ignore the low battery warnings, the Notebook PC eventually enters suspend mode (Windows default uses STR).



WARNING! Suspend-to-RAM (STR) does not last long when the battery power is depleted. Suspend-to-Disk (STD) is not the same as power OFF. STD requires a small amount of power and will fail if no power is available due to complete battery depletion or no power supply (e.g. removing both the power adapter and battery pack).

Charging the Battery Pack

Before you use your Notebook PC on the road, you will have to charge the battery pack. The battery pack begins to charge as soon as the Notebook PC is connected to external power using the power adapter. Fully charge the battery pack before using it for the first time. A new battery pack must completely charge before the Notebook PC is disconnected from external power. It takes a few hours to fully charge the battery when the Notebook PC is turned OFF and may take twice the time when the Notebook PC is turned ON. The battery status indicator on the Notebook PC turns OFF when the battery pack is charged.



NOTE: The battery stops charging if the temperature is too high or the battery voltage is too high.



WARNING! Do not leave the battery pack discharged. The battery pack will discharge over time. If not using a battery pack, it must continued to be charged every three months to extend recovery capacity or else it may fail to charge in the future.

3 Getting Started

Power Options

The power switch turns ON and OFF the Notebook PC or putting the Notebook PC into sleep or hibernation modes. Actual behavior of the power switch can be customized in Windows Control Panel “Power Options.”

For other options, such as “Switch User, Restart, Sleep, or Shut Down,” click the arrowhead next to the lock icon.

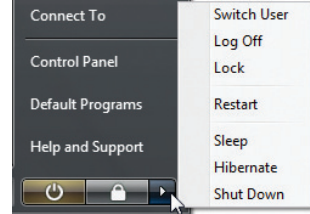

Restarting or Rebooting

After making changes to your operating system, you may be prompted to restart the system. Some installation processes will provide a dialog box to allow restart. To restart the system manually, choose **Restart**.

IMPORTANT! To protect the hard drive, wait at least 5 seconds after turning OFF your Notebook PC before turning it back ON.

Emergency Shutdown

In case your operating system cannot properly turn OFF or restart, there are two additional ways to shutdown your Notebook PC:

(1) Hold the power button  over 4 seconds, or

(2) Press the shutdown button  on the bottom.

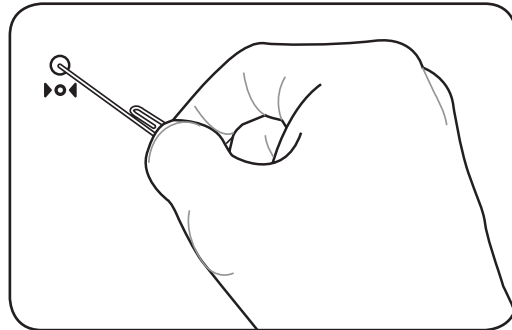
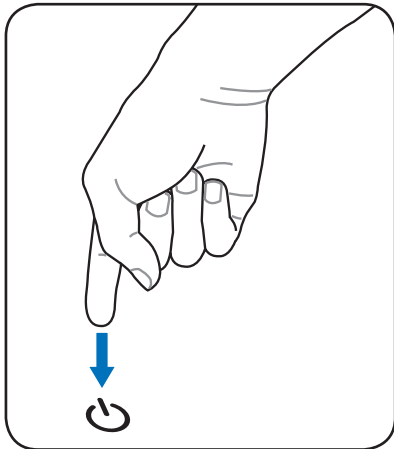

TIP: Use a straightened paper clip to press the shutdown button.

IMPORTANT! Do not use emergency shutdown while data is being written; doing so can result in loss or destruction of your data.



Power Management Modes

The Notebook PC has a number of automatic or adjustable power saving features that you can use to maximize battery life and lower Total Cost of Ownership (TCO). You can control some of these features through the Power menu in the BIOS Setup. ACPI power management settings are made through the operating system. The power management features are designed to save as much electricity as possible by putting components into a low power consumption mode as often as possible but also allow full operation on demand.

Sleep and Hibernate

Power management settings can be found in the Windows > Control Panel > **Power Options**. In **System Settings**, you can define “Sleep/Hibernate” or “Shut Down” for closing the display panel or pressing the power button. “Sleep” and “Hibernate” saves power when your Notebook PC is not in use by turning OFF certain components. When you resume your work, your last status (such as a document scrolled down half way or email typed half way) will reappear as if you never left. “Shut Down” will close all applications and ask if you want to save your work if any are not saved.

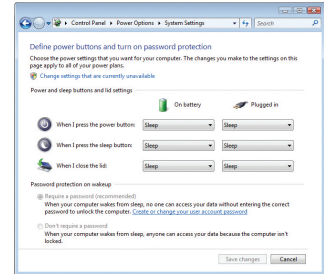

Sleep is the same as Suspend-to-RAM (STR). This function stores your current data and status in RAM while many components are turned OFF. Because RAM is volatile, it requires power to keep (refresh) the data. Click the **Start** button and the arrowhead next to the lock icon to see this option. You can also use the keyboard shortcut [**Fn F1**] to activate this mode. Recover by pressing any keyboard key except [Fn]. (NOTE: The power indicator will blink in this mode.)

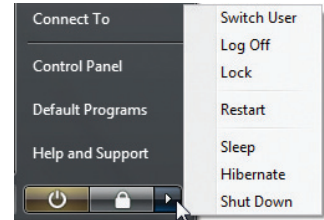

Hibernate is the same as Suspend-to-Disk (STD) and stores your current data and status on the hard disk drive. By doing this, RAM does not have to be periodically refreshed and power consumption is greatly reduced but not completely eliminated because certain wake-up components like LAN needs to remain powered. “Hibernate” saves more power compared to “Sleep”. Click the **Start** button and the arrowhead next to the lock icon to see this option. Recover by pressing the power button. (NOTE: The power indicator will be OFF in this mode.)

Thermal Power Control

There are three power control methods for controlling the Notebook PC’s thermal state. These power control cannot be configured by the user and should be known in case the Notebook PC should enter these states. The following temperatures represent the chassis temperature (not CPU).

- The fan turns ON for active cooling when the temperature reaches the safe upper limit.
- The CPU decreases speed for passive cooling when the temperature exceeds the safe upper limit.
- The system shut down for critical cooling when temperature exceeds the maximum safe upper limit.

Special Keyboard Functions

Colored Hot Keys

The following defines the colored hot keys on the Notebook PC's keyboard. The colored commands can only be accessed by first pressing and holding the function key while pressing a key with a colored command.



NOTE: The Hot Key locations on the function keys may vary depending on model but the functions should remain the same.



“ZZ” Icon (F1): Places the Notebook PC in suspend mode (either Save-to-RAM or Save-to-Disk depending on sleep button setting in power management setup).



Radio Tower (F2): Wireless Models Only: Toggles the internal wireless LAN or Bluetooth (on selected models) ON or OFF with an on-screen-display. When enabled, the corresponding wireless indicator will light. Windows software settings are necessary to use the wireless LAN or Bluetooth.



Envelope Icon (F3): Pressing this button will launch your Email application while Windows is running.



“e” Icon (F4): Pressing this button will launch your Internet browser application while Windows is running.



Filled Sun Icon (F5):
Decreases the display brightness



Open Sun Icon (F6):
Increases the display brightness



LCD Icon (F7): Toggles the display panel ON and OFF. (On certain models; stretches the screen area to fill the entire display when using low resolution modes.)



LCD/Monitor Icons (F8): Toggles between the Notebook PC's LCD display and an external monitor in this series: Notebook PC LCD -> External Monitor -> Both. (This function does not work in 256 Colors, select High Color in Display Property Settings.)
NOTE: Must connect an external monitor “before” booting up.





































Crossed-out Touchpad (F9): Toggles the built-in touchpad LOCKED (disabled) and UNLOCKED (enabled). Locking the touchpad will prevent you from accidentally moving the cursor while typing and is best used with an external pointing device such as a mouse. NOTE: Selected models have an indicator between the touchpad buttons will light when the touchpad is UNLOCKED (enabled) and not light when the touchpad is LOCKED (disabled).



Colored Hot Keys (cont.)



-
- 

Speaker Icons (F10): Toggles the speakers ON and OFF (only in Windows OS)
 
-
- 

Speaker Down Icon (F11): Decreases the speaker volume (only in Windows OS)
 
-
- 

Speaker Up Icon (F12): Increases the speaker volume (only in Windows OS)
 
-
- 

Num Lk (Ins): Toggles the numeric keypad (number lock) ON and OFF. Allows you to use a larger portion of the keyboard for number entering.
 
-
- 

Scr Lk (Del): Toggles the “Scroll Lock” ON and OFF. Allows you to use a larger portion of the keyboard for cell navigation.
 
-
- 

Fn+C: Toggles “Splendid Video Intelligent Technology” function ON and OFF. This allows switching between different display color enhancement modes in order to improve contrast, brightness, skin tone, and color saturation for red, green, and blue independently. You can see the current mode through the on-screen display (OSD).
 



-
- 

Fn+V: Toggles “Life Frame” software application.
 
-
- 

Fn+T: Toggles “Power For Phone” software application.
 
-
- 

Power4Gear eXtreme (Fn+Space Bar): This key toggles power savings between various power saving modes. The power saving modes control many aspects of the Notebook PC to maximize performance versus battery time. Applying or removing the power adapter will automatically switch the system between AC mode and battery mode. You can see the current mode through the on-screen display (OSD).
 



-

3 Getting Started

Microsoft Windows Keys

There are two special Windows keys on the keyboard as described below.



The key with the Windows Logo activates the Start menu located at the bottom left of the Windows desktop.



The other key, that looks like a Windows menu with a small cursor, activates the properties menu and is equivalent to pressing the right mouse button on a Windows object.

Keyboard as a Numeric Keypad

The numeric keypad is embedded in the keyboard and consists of 15 keys that make number intensive input more convenient.

These dual-purpose keys are labeled in orange on the key caps.

Numeric assignments are located at the upper right hand corner of each key as shown in the figure.

When the numeric keypad is engaged by pressing [Fn][Ins/Num LK], the number lock LED lights up.

If an external keyboard is connected, pressing the [Ins/Num LK] on the external keyboard enables/disables the NumLock on both keyboards simultaneously. To disable the numeric keypad while keeping the keypad on an external keyboard activated, press the [Fn][Ins/Num LK] keys on the Notebook PC.

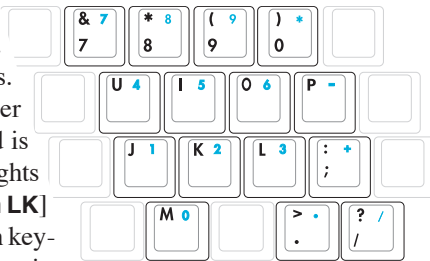

Keyboard as Cursors

The keyboard can be used as cursors while Number Lock is ON or OFF in order to increase navigation ease while entering numeric data in spreadsheets or similar applications.

With Number Lock OFF, press [Fn] and one of the cursor keys shown below. For example [Fn][8] for up, [Fn][K] for down, [Fn][U] for left, and [Fn][O] for right.

With Number Lock ON, use [Shift] and one of the cursor keys shown below. For example [Shift][8] for up, [Shift][K] for down, [Shift][U] for left, and [Shift][O] for right.

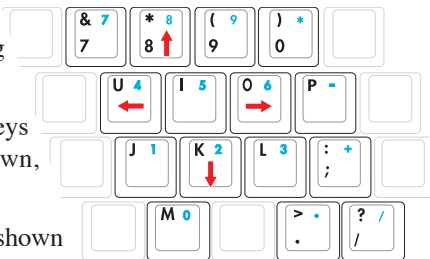

NOTE: The red arrows are illustrated here for your reference. They are not labeled on the keyboard as shown here.

Switches and Status Indicators

Switches

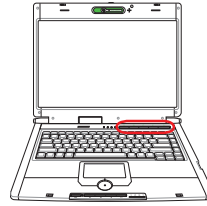
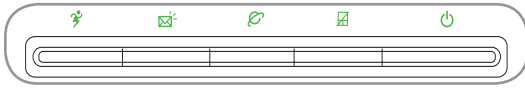

Power4Gear eXtreme Key

The Power4Gear eXtreme key toggles power savings between various power saving modes. The power saving modes control many aspects of the Notebook PC to maximize performance versus battery time. Applying or removing the power adapter will automatically switch the system between AC mode and battery mode. The selected mode is shown on the display.



Email Launch Key

Pressing this button will launch your Email application while Windows is running.



Internet Launch Key

Pressing this button will launch your Internet browser application while Windows is running.



Touchpad Lock Key

Pressing this button will lock (disable) the built-in touchpad. Locking the touchpad will prevent you from accidentally moving the cursor while typing and is best used with an external mouse (pointing device). To unlock (enable) the touchpad, simply press this button again.

Power Switch

The power switch turns ON and OFF the Notebook PC or putting the Notebook PC into sleep or hibernation modes. Actual behavior of the power switch can be customized in Windows Control Panel “Power Options.”



Switches and Status Indicators (cont.)

Switches (cont.)

Multimedia Control Keys

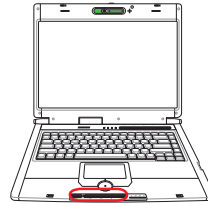
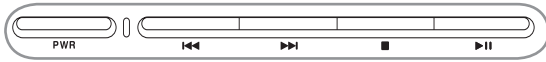

The multimedia control keys allows for convenient controlling of the multimedia application. The following defines the meaning of each multimedia control key on the Notebook PC.

CD Play/Pause

During CD stop, begins CD play.

During CD play, pauses CD play.

CD Stop

During CD stop: Ejects the CD tray.

During CD play: Stops CD play.

CD Skip to Previous Track (Rewind) & Audio Volume Down

During CD play, this button has two functions:

Track: The first push will restart the current track. Second push will skip to the **previous** track.

Audio: Hold down to **decrease** audio volume.

CD Skip to Next Track (Fast Forward) & Audio Volume Up

During CD play, this button has two functions:

Track: Push once to skip to the **next** track during CD playing.

Audio: Hold down to **increase** audio volume.

Audio Volume Controls

 **Fn + Speaker Icons (F10):** Toggles the audio volume ON and OFF

 **Fn + Down Speaker Icon (F11):** Decreases the audio volume

 **Fn + Up Speaker Icon (F12):** Increases the audio volume

Switches and Status Indicators (cont.)

Status Indicators

Front

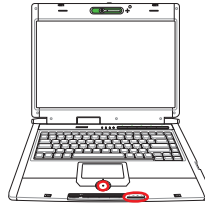

Power Indicator

The power indicator lights when the Notebook PC is turned ON and blinks slowly when the Notebook PC is in the Suspend-to-RAM (Sleep) mode. This indicator is OFF when the Notebook PC is turned OFF or in the Suspend-to-Disk (Hibernation) mode.



Battery Charge Indicator

The battery charge indicator shows the status of the battery's power as follows:

ON: The Notebook PC's battery is charging when AC power is connected.

OFF: The Notebook PC's battery is charged or completely drained.

Blinking: Battery power is less than 10% and the AC power is not connected.



Email Indicator

Flashes when there is one or more new email(s) in your email program's inbox. This function requires software setup and may not be currently configured on your Notebook PC. This function is designed for Microsoft email software only and may not work with email software from other companies.



Wireless Indicator

This is only applicable on models with built-in wireless LAN and/or built-in Bluetooth. When the built-in wireless LAN and/or built-in Bluetooth is enabled, this indicator will light. (Windows software settings are necessary.)



Pad-Lock Indicator (between touchpad buttons)

This indicator will light when the built-in touchpad is UNLOCKED (enabled). When the built-in touchpad is LOCKED (disabled), this indicator will not light. Locking the touchpad will prevent you from accidentally moving the cursor while typing and is best used with an external pointing device such as a mouse.



4 Using the Notebook PC

Switches and Status Indicators (cont.)

Status Indicators (cont.)

Top

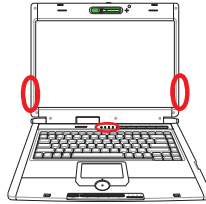
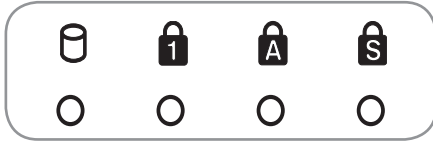

Drive Activity Indicator

Indicates that the Notebook PC is accessing one or more storage device(s) such as the hard disk. The light flashes proportional to the access time.



Number Lock Indicator

Indicates that number lock [Num Lk] is activated when lighted. Number lock allows some of the keyboard letters to act as numbers for easier numeric data input.



Capital Lock Indicator

Indicates that capital lock [Caps Lock] is activated when lighted. Capital lock allows some of the keyboard letters to type using capitalized letters (e.g. A, B, C). When the capital lock light is OFF, the typed letters will be in the lower case form (e.g. a,b,c).



Scroll Lock Indicator

Indicates that scroll lock [Scr Lk] is activated when lit. Scroll lock allows some of the keyboard letters to act as direction keys in order to allow easier navigation when only a part of the keyboard is required, such as for playing games.



Direct Flash Indicator

The direct flash indicator blinks when Microsoft DirectX 9/10 (used with most games) is running. Use the provided Direct Console software (see next page) to enable or disable this function.



Status Indicators

Direct Messenger Display

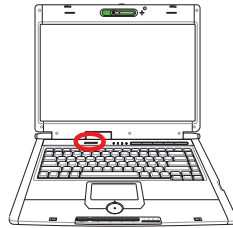

Default display when no status is present.

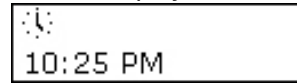

Display when one or more status is present.

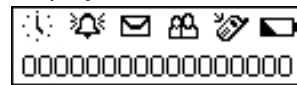

Icon area: more than one may be shown.

Message area: scrolls long messages

Direct Messenger Software

Direct Messenger provides status for MS Outlook items, phone calls, and battery level. You can use the provided Direct Console software to customize the default display. Direct console can be opened from the taskbar or from **Windows | Start Programs | ASUS Utility | ASUS Direct Console**.

ASUS Direct Console - Main screen

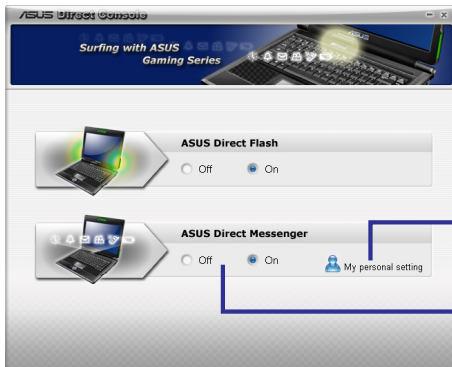

Open personal settings

Enable or disable Direct Messenger

Personal settings screen - Default setting

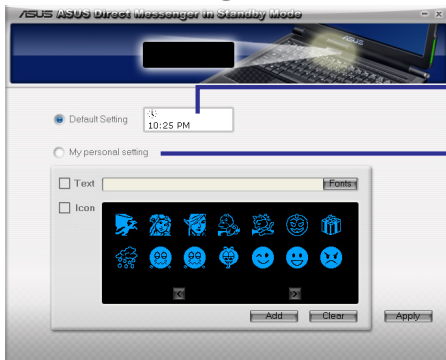

Default: Clock icon and time

Personal setting: Create your own text and icon instead of using the default clock and time.

4 Using the Notebook PC

Status Indicators

Direct Messenger Display (Cont.)

Personal settings screen - My personal setting

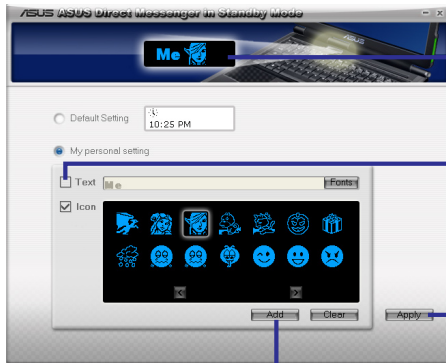

Preview window

Check **Text** to enter text or **Icon** to select an icon. (You can add text or icons repeatedly.)

Click **Apply** to send your personal text/icon to the Direct Messenger display.

Click **Add** after typing a text or selecting an icon. (You can add text or icons repeatedly.)



NOTE: The default setting or personal settings will only display when all of the alarms have been dismissed.

Direct Messenger Icons

- Clock icon - Default mode when no status is present; otherwise your own icon or text.
- MS Outlook Meeting Alarm - Meeting venue, subject, and time will be scrolled below. Icon will disappear 5 mins after set meeting time.
- MS Outlook email - Email sender and subject will be scrolled below. Icon will disappear after reading all new emails.
- MS Messenger Call - Message sender (no message) will be scrolled below. Icon will disappear after replying or closing the last message (older messages may be showing).
- Power4Phone Call - Caller ID (if available) will be scrolled below.
- Notebook PC Battery Low - Battery power remaining from 10% will be scrolled below. Icon will disappear after connecting external power (using the provided power adapter).

4. Using the Notebook PC

Pointing Device

Storage Devices

Expansion Card

Optical drive

Flash memory card reader

Hard disk drive

Memory (RAM)

Connections

Modem Connection

Network Connection

Wireless LAN Connection (on selected models)

Bluetooth Wireless Connection (on selected models)

Trusted Platform Module (TPM) (on selected models)



NOTE: Photos and icons in this manual are used for artistic purposes only and do not show what is actually used in the product itself.

4 Using the Notebook PC

Pointing Device

The Notebook PC's integrated touchpad pointing device is fully compatible with all two/three-button and scrolling knob PS/2 mice. The touchpad is pressure sensitive and contains no moving parts; therefore, mechanical failures can be avoided. A device driver is still required for working with some application software.



IMPORTANT! Do not use any objects in place of your finger to operate the touchpad or else damage may occur to the touchpad's surface.

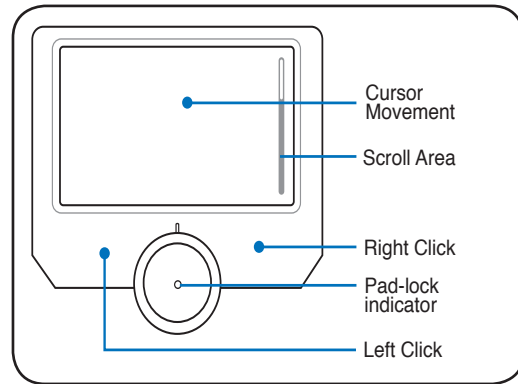

Using the Touchpad

Light pressure with the tip of your finger is all that is required to operate the touchpad. Because the touchpad is electrostatic sensitive, objects cannot be used in place of your fingers. The touchpad's primary function is to move the cursor around or select items displayed on the screen with the use of your fingertip instead of a standard desktop mouse. The following illustrations demonstrate proper use of the touchpad.

Moving The Cursor

Place your finger in the center of the touchpad and slide in a direction to move the cursor.

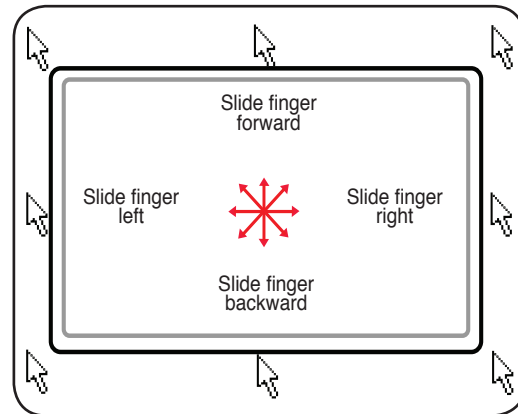

Scrolling (on selected models)

Slide your finger up or down on the right side to scroll a window up or down.

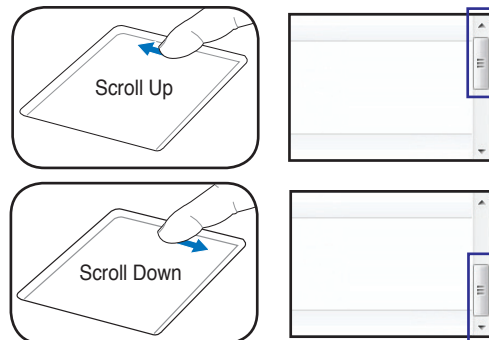

NOTE: A software-controlled scrolling function is available after setting up the included touchpad utility to allow easy Windows or web navigation.

☐ Touchpad Usage Illustrations

Clicking/Tapping - With the cursor over an item, press the left button or use your fingertip to touch the touchpad lightly, keeping your finger on the touchpad until the item is selected. The selected item will change color. The following 2 examples produce the same results.

Clicking

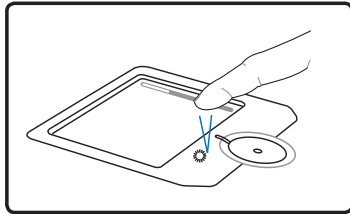

Press the left cursor button and release.

Tapping

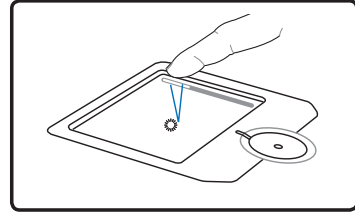

Lightly but rapidly strike the touchpad.

Double-clicking/Double-tapping - This is a common skill for launching a program directly from the corresponding icon you select. Move the cursor over the icon you wish to execute, press the left button or tap the pad twice in rapid succession, and the system launches the corresponding program. If the interval between the clicks or taps is too long, the operation will not be executed. You can set the double-click speed using the Windows Control Panel "Mouse." The following 2 examples produce the same results.

Double-Clicking

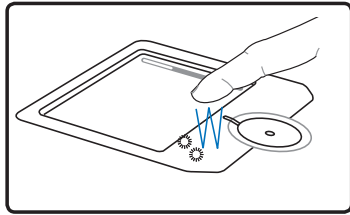

Press the left button twice and release.

Double-Tapping

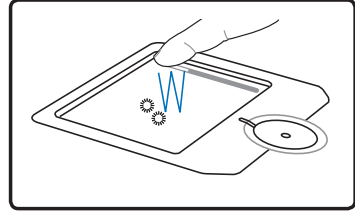

Lightly but rapidly strike the touchpad twice.

Dragging - Dragging means to pick up an item and place it anywhere on the screen you wish. You can move the cursor over the item you select, and while keeping the left button depressed, moving the cursor to the desired location, then release the button. Or, you can simply double-tap on the item and hold while dragging the item with your fingertip. The following illustrations produce the same results.

Dragging-Clicking

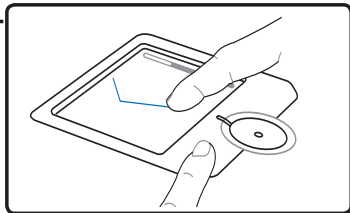

Hold left button and slide finger on touchpad.

Dragging-Tapping

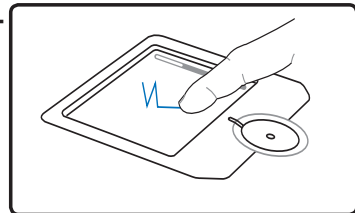

Lightly strike the touchpad twice, sliding finger on touchpad during second strike.

4 Using the Notebook PC

☐ Caring for the Touchpad

The touchpad is pressure sensitive. If not properly cared for, it can be easily damaged. Take note of the following precautions.

- Make sure the touchpad does not come into contact with dirt, liquids or grease.
- Do not touch the touchpad if your fingers are dirty or wet.
- Do not rest heavy objects on the touchpad or the touchpad buttons.
- Do not scratch the touchpad with your finger nails or any hard objects.



NOTE: The touchpad responds to movement not to force. There is no need to tap the surface too hard. Tapping too hard does not increase the responsiveness of the touchpad. The touchpad responds best to light pressure.

☐ Automatic Touchpad Disabling (Synaptics)

Windows can automatically disable the Notebook PC's touchpad when an external USB mouse is attached. This feature is normally OFF, to turn ON this feature, select the option in Windows **Control Panel > Mouse Properties > Device Settings**.

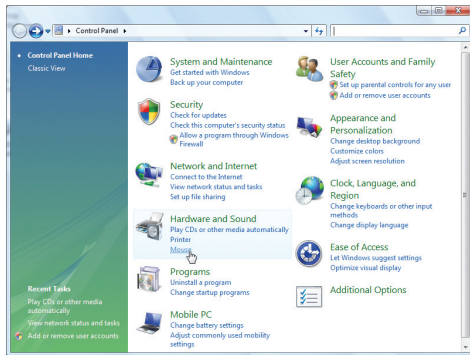

Find **Mouse** properties in the “Control Panel”.

Models with Synaptics touchpad.

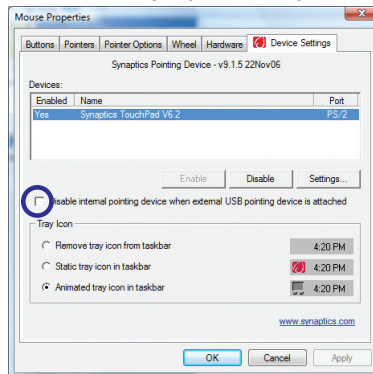

Select this option to enable this feature.

Models with ALPS touchpad do not have this feature.

Models with ALPS touchpad.

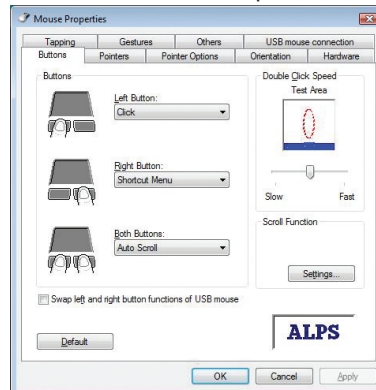

Gaming Optical Mouse (on selected models)

The gaming optical mouse is a standard mouse with some added software features for easier controls when playing games.

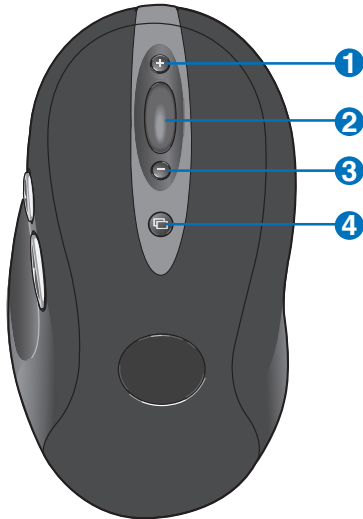

Parts of the mouse (top)

- (1) **In-game dpi Increase:** Press button to increase dpi of tracking sensitivity.
- (2) **Scrolling and Zooming:** Roll wheel up to scroll up; roll wheel down to scroll down. To zoom, press wheel down, and then roll wheel up to zoom in; roll wheel down to zoom out. Press any button to release zoom. (Not all applications support zooming.)
- (3) **In-game dpi Decrease:** Press button to decrease dpi of tracking sensitivity.
- (4) **Application Switch Button:** Press to switch between open documents.

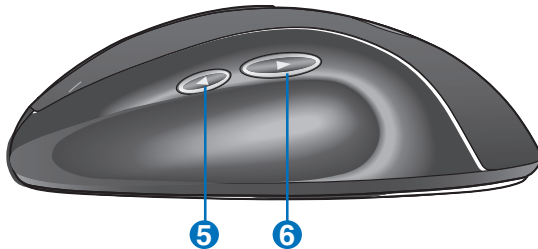

Parts of the mouse (side)

- (5) **Forward Button**
- (6) **Back Button:** Use both buttons with your web browser or with other applications.

4 Using the Notebook PC

Gaming Optical Mouse (on selected models) Cont.

In-play sensitivity switching

The mouse has out-of-box access to three levels of tracking sensitivity - 1600dpi, 800dpi, and 400dpi. 800dpi is the default setting. Use the SetPoint software that comes with the mouse (1) and its Advanced Game Settings feature (2) to configure up to five personalized sensitivity levels between 400dpi and 1600dpi. Sensitivity levels require an ascending order (3). Refer to the software help system (4) to learn how to choose sensitivity levels, and to learn more about the mouse and its software.

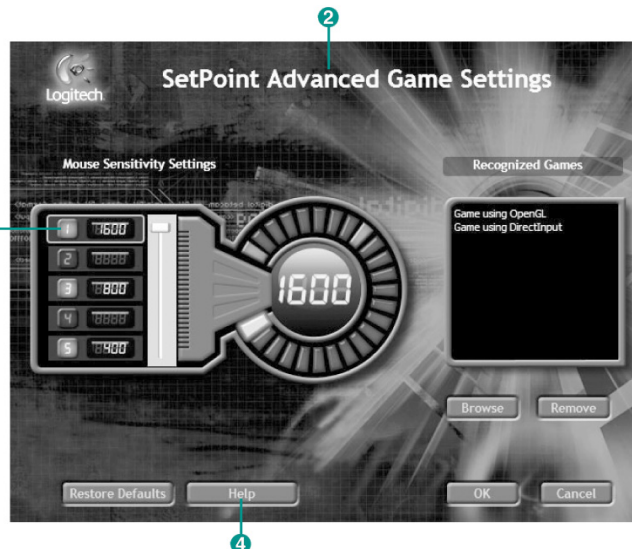

Storage Devices

Storage devices allow the Notebook PC to read or write documents, pictures, and other files to various data storage devices. This Notebook PC has the following storage devices:

- Expansion Card
- Optical drive
- Flash memory reader
- Hard disk drive

Expansion Card

One 26pin Express card slot is available to support one ExpressCard/34mm or one ExpressCard/54mm expansion card. This new interface is faster by using a serial bus supporting USB 2.0 and PCI Express instead of the slower parallel bus used in the PC card slot. (Not compatible with previous PCMCIA cards.)



Inserting an Expansion Card

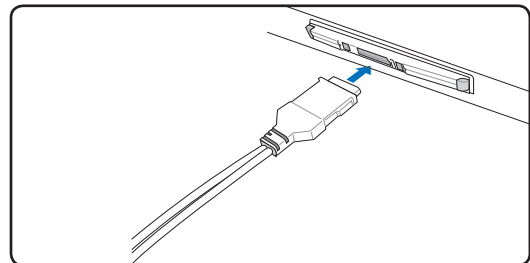
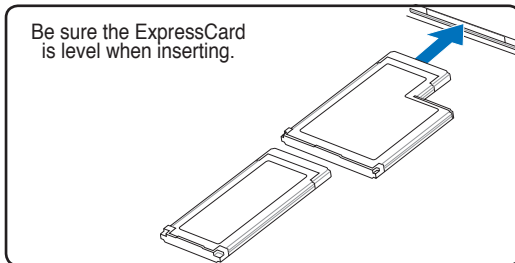

1. If there is an ExpressCard socket protector, remove it using the “Removing an ExpressCard” instructions below.
2. Insert the ExpressCard with the connector side first and label side up. Standard ExpressCards will be flush with the Notebook PC when fully inserted.
3. Carefully connect any cables or adapters needed by the ExpressCard. Usually connectors can only be inserted in one orientation. Look for a sticker, icon, or marking on one side of the connector representing the top side.

Removing an Expansion Card

The ExpressCard slot does not have an eject button. Press the ExpressCard inwards and release to eject the ExpressCard. Carefully pull the ejected ExpressCard out of the socket.

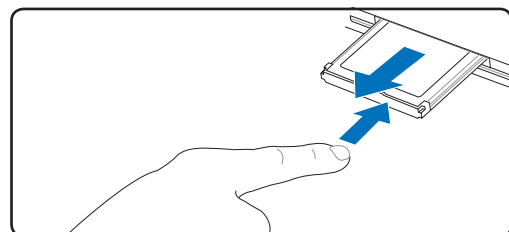

4 Using the Notebook PC

Optical Drive

Inserting an optical disc

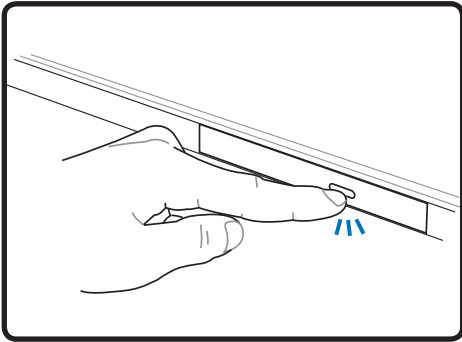

1. While the Notebook PC's power is ON, press the drive's eject button and the tray will eject partially.

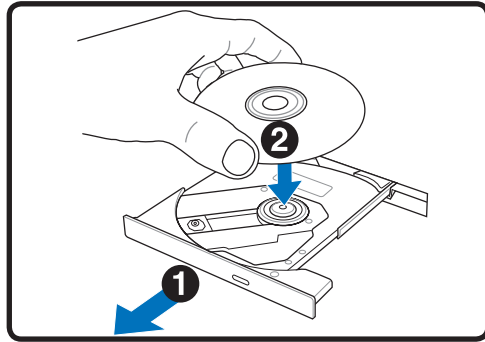

2. Gently pull on the drive's front panel and slide the tray completely out. Be careful not to touch the CD drive lens and other mechanisms. Make sure there are no obstructions that may get jammed under the drive's tray.

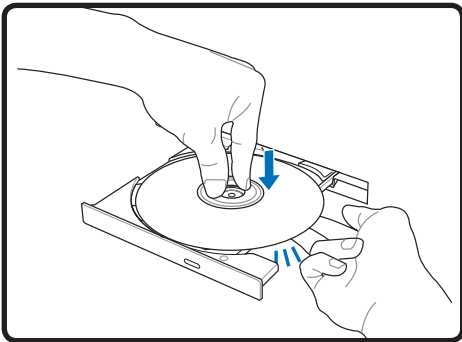

3. Hold the disc by the edge and face the disc's printed side up. Push down on both sides of the disc's center until the disc snaps onto the hub. **The hub should be higher than the disc when correctly mounted.**

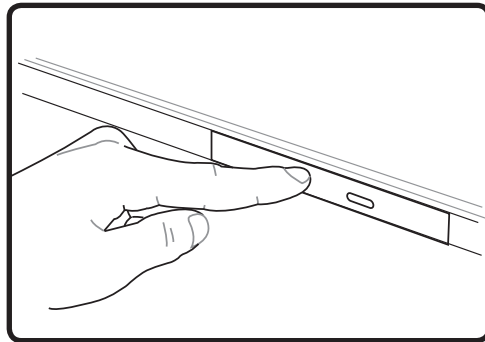

4. Slowly push the drive's tray back in. The drive will begin reading the table of contents (TOC) on the disc. When the drive stops, the disc is ready to be used.



NOTE: It is normal to hear as well as feel the CD spinning with great intensity in the CD drive while data is read.

⊙ Optical Drive (Cont.)

Removing an optical disc

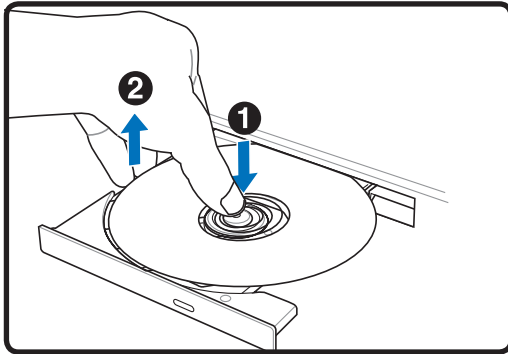

Eject the tray and gently pry the edge of the disc upwards at an angle to remove the disc from the hub.

Emergency eject

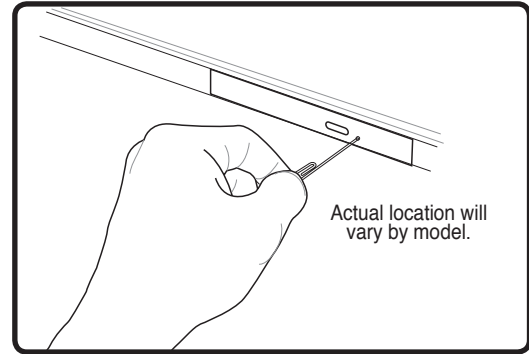

The emergency eject is located in a hole on the optical drive and is used to eject the optical drive tray in case the electronic eject does not work. Do not use the emergency eject in place of the electronic eject. **Note: Make sure not to stab the activity indicator located in the same area.**

⊙ Using the Optical Drive

Optical discs and equipment must be handled with care because of the precise mechanics involved. Keep in mind the important safety instructions from your CD suppliers. Unlike desktop optical drives, the Notebook PC uses a hub to hold the CD in place regardless of the angle. When inserting a CD, it is important that the CD be pressed onto the center hub or else the optical drive tray will scratch the CD.

⚠ WARNING! If the CD disc is not properly locked onto the center hub, the CD can be damaged when the tray is closed. Always watch the CD closely while closing the tray slowly to prevent damage.

A CD drive letter should be present regardless of the presence of a CD disc in the drive. After the CD is properly inserted, data can be accessed just like with hard disk drives; except that nothing can be written to or changed on the CD. Using the proper software, a CD-RW drive or DVD+CD-RW drive can allow CD-RW discs to be used like a hard drive with writing, deleting, and editing capabilities.

Vibration is normal for all high-speed optical drives due to unbalanced CDs or CD print. To decrease vibration, use the Notebook PC on an even surface and do not place labels on the CD.

Listening to Audio CD

The optical drives can play audio CDs, but only the DVD-ROM drive can play DVD audio. Insert the audio CD and Windows automatically opens an audio player and begins playing. Depending on the DVD audio disc and installed software, it may require that you open a DVD player to listen to DVD audio. You can adjust the volume using hotkeys or Windows speaker icon on the taskbar.

4 Using the Notebook PC

Flash Memory Card Reader

Normally a memory card reader must be purchased separately in order to use memory cards from devices such as digital cameras, MP3 players, mobile phones, and PDAs. This Notebook PC has a single built-in memory card reader that can use many flash memory cards as shown in the example below. The built-in memory card reader is not only convenient, but also faster than most other forms of memory card readers because it utilizes the internal high-bandwidth PCI bus.

IMPORTANT! Flash memory card compatibility varies depending on Notebook PC model and flash memory card specifications. Flash memory card specifications constantly change so compatibility may change without warning.

Flash Memory Card Examples

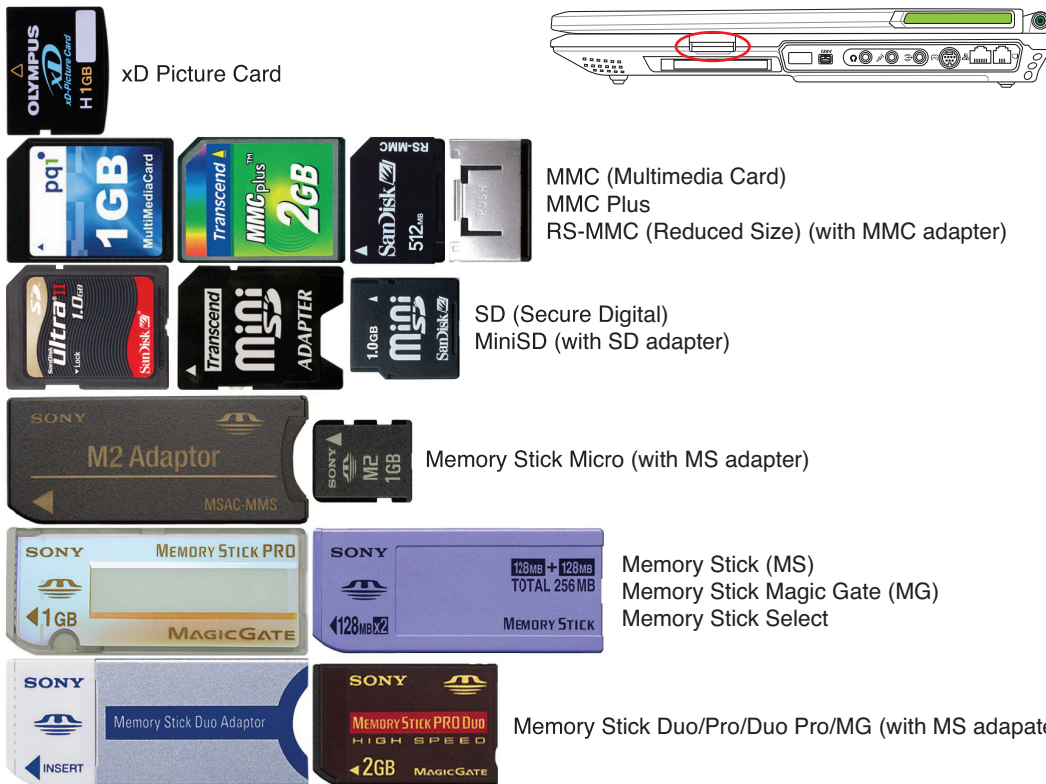

IMPORTANT! Never remove cards while or immediately after reading, copying, formatting, or deleting data on the card or else data loss may occur.



WARNING! To prevent data loss, use “Windows Safely Remove Hardware” on the taskbar before removing the flash memory card.

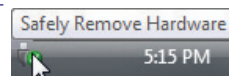

 **Hard Disk Drive**

Hard disk drives have higher capacities and operate at much faster speeds than floppy disk drives and optical drives. The Notebook PC comes with a replaceable hard disk drive. Current hard drives support S.M.A.R.T. (Self Monitoring and Reporting Technology) to detect hard disk errors or failures before they happen. When replacing or upgrading the hard drive, always visit an authorized service center or retailer for this Notebook PC.

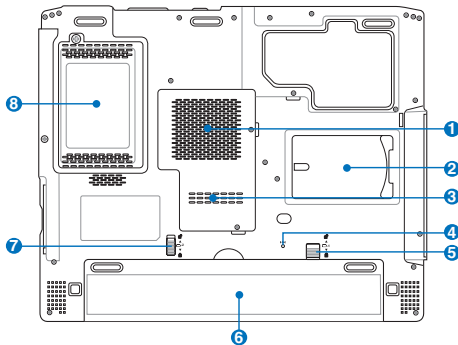

IMPORTANT! Poor handling of the Notebook PC may damage the hard disk drive. Handle the Notebook PC gently and keep it away from static electricity and strong vibrations or impact. The hard disk drive is the most delicate component and will likely be the first or only component that is damaged if the Notebook PC is dropped.

**8 Hard Disk Drive Compartment**

The hard disk drive is secured in a compartment. Visit an authorized service center or retailer for information on hard disk drive upgrades for your Notebook PC. Only purchase hard disk drives from authorized retailers of this Notebook PC to ensure maximum compatibility and reliability.

4 Using the Notebook PC

Memory (RAM)

Additional memory will increase application performance by decreasing hard disk access. The BIOS automatically detects the amount of memory in the system and configures CMOS accordingly during the POST (Power-On-Self-Test) process. There is no hardware or software (including BIOS) setup required after the memory is installed.

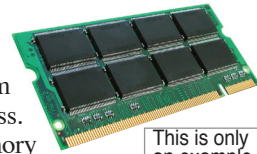

This is only an example.

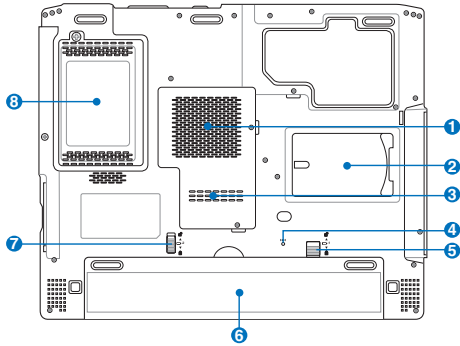

- 1 The memory compartment provides expansion capabilities for additional memory. Visit an authorized service center or retailer for information on memory upgrades for your Notebook PC. Only purchase expansion modules from authorized retailers of this Notebook PC to ensure maximum compatibility and reliability.

Installing a Memory Card:

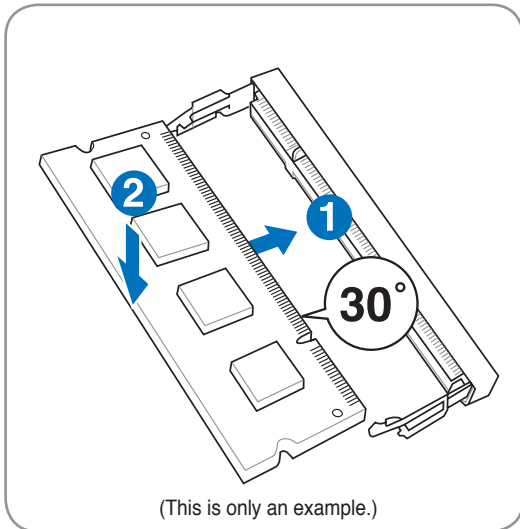

Removing a Memory Card:

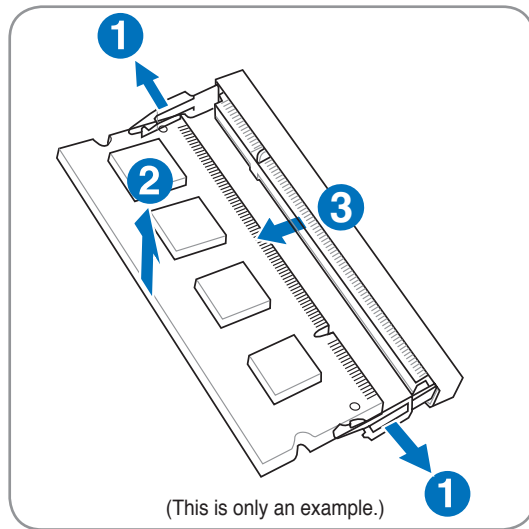

Connections

 **NOTE:** The built-in modem and network cannot be installed later as an upgrade. After purchase, modem and/or network can be installed as an expansion card.

Modem Connection

The telephone wire used to connect the Notebook PC's internal modem should have either two or four wires (only two wires (telephone line #1) is used by the modem) and should have an RJ-11 connector on both ends. Connect one end to the modem port and the other end to an analog telephone wall socket (the ones found in residential buildings). Once the driver is setup, the modem is ready to use.



 **NOTE:** When you are connected to an online service, do not place the Notebook PC in suspend (or sleep mode) or else you will disconnect the modem connection.

 **Example of the Notebook PC connected to a telephone jack for use with the built-in modem:**

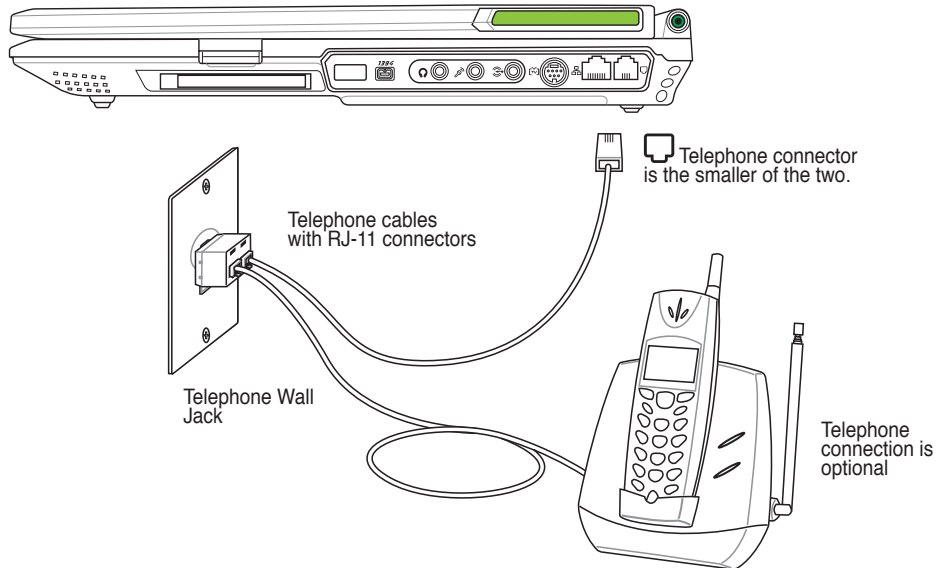

 **CAUTION:** For electrical safety concerns, only use telephone cables rated 26AWG or higher. (see Glossary for more information)

4 Using the Notebook PC

Network Connection

Connect a network cable, with RJ-45 connectors on each end, to the modem/network port on the Notebook PC and the other end to a hub or switch. For 100 BASE-TX / 1000 BASE-T speeds, your network cable must be category 5 or better (not category 3) with twisted-pair wiring. If you plan on running the interface at 100/1000Mbps, it must be connected to a 100 BASE-TX / 1000 BASE-T hub (not a BASE-T4 hub). For 10Base-T, use category 3, 4, or 5 twisted-pair wiring. 10/100 Mbps Full-Duplex is supported on this Notebook PC but requires connection to a network switching hub with “duplex” enabled. The software default is to use the fastest setting so no user-intervention is required.

 **1000BASE-T (or Gigabit) is only supported on selected models.**

Twisted-Pair Cable

The cable used to connect the Ethernet card to a host (generally a Hub or Switch) is called a straight-through Twisted Pair Ethernet (TPE). The end connectors are called RJ-45 connectors, which are not compatible with RJ-11 telephone connectors. If connecting two computers together without a hub in between, a crossover LAN cable is required (Fast-Ethernet model). (Gigabit models support auto-crossover so a crossover LAN cable is optional.)



 **Example of the Notebook PC connected to a Network Hub or Switch for use with the built-in Ethernet controller.**

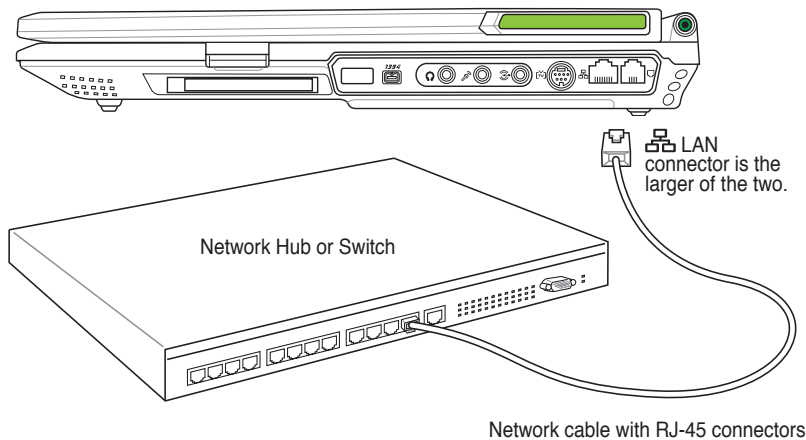

WARNING! Only use analog telephone outlets. The built-in modem does not support the voltage used in digital phone systems. Do not connect the RJ-11 to digital phone systems found in many commercial buildings or else damage will occur!

Wireless LAN Connection (on selected models)

The optional built-in wireless LAN is a compact easy-to-use wireless Ethernet adapter. Implementing the IEEE 802.11 standard for wireless LAN (WLAN), the optional built-in wireless LAN is capable of fast data transmission rates using Direct Sequence Spread Spectrum (DSSS) and Orthogonal Frequency Division Multiplexing (OFDM) technologies on 2.4GHz/5GHz frequencies. The optional built-in wireless LAN is backward compatible with the earlier IEEE 802.11 standards allowing seamless interfacing of wireless LAN standards.

The optional built-in wireless LAN is a client adapter that supports Infrastructure and Ad-hoc modes giving you flexibility on your existing or future wireless network configurations for distances up to 40 meters between the client and the access point.

To provide efficient security to your wireless communication, the optional built-in wireless LAN comes with a 64-bit/128-bit Wired Equivalent Privacy (WEP) encryption and Wi-Fi Protected Access (WPA) features.

These are examples of the Notebook PC connected to a Wireless Network.

Ad-hoc mode

The Ad-hoc mode allows the Notebook PC to connect to another wireless device. No access point (AP) is required in this wireless environment.

(All devices must install optional 802.11 wireless LAN adapters.)

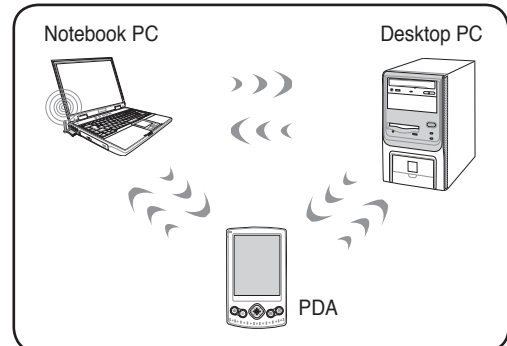

Infrastructure mode

The Infrastructure mode allows the Notebook PC and other wireless devices to join a wireless network created by an Access Point (AP) (sold separately) that provides a central link for wireless clients to communicate with each other or with a wired network.

(All devices must install optional 802.11 wireless LAN adapters.)

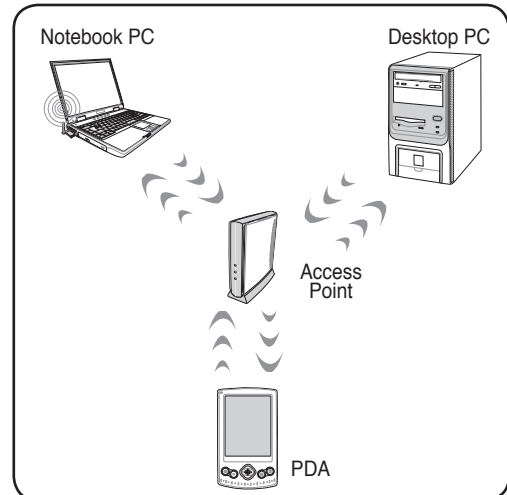

4 Using the Notebook PC

Windows Wireless Network Connection Connecting to a network

1. Switch ON the Wireless function if necessary for your model (see switches in Section 3).



2. Press [FN F2] repeatedly until **Wireless LAN ON** or **WLAN & Bluetooth ON** is shown.
- 2b. Or double click the Wireless Console icon on the taskbar and select either the Wireless LAN + Bluetooth or just the Bluetooth.

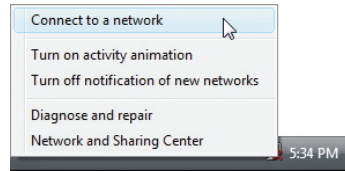
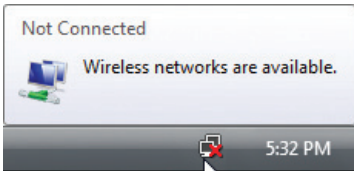

3. You should see the “Not Connected” network icon.
4. Right click on the network icon and select **Connect to a network**.

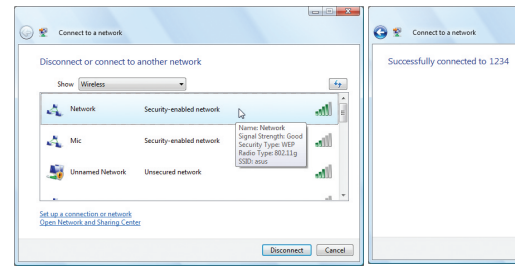
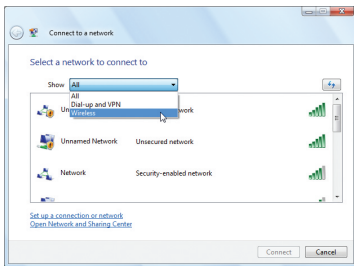

5. Select “Show **Wireless**” if you have many networks in your area.
6. Select the wireless network you want to connect to.

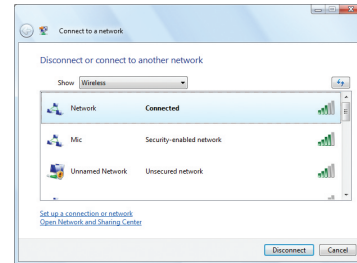
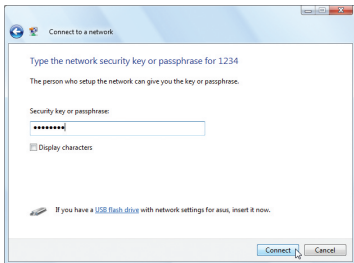

7. When connecting, you may have to enter a password.
8. After connection has been established, “Connected” will be shown.

Bluetooth Wireless Connection (on selected models)

Notebook PCs with Bluetooth technology eliminates the need for cables for connecting Bluetooth-enabled devices. Examples of Bluetooth-enabled devices may be Notebook PCs, Desktop PCs, mobile phones, and PDAs.



Note: If your Notebook PC did not come with built-in Bluetooth, you need to connect a USB or ExpressCard Bluetooth module in order to use Bluetooth.

Bluetooth-enabled mobile phones

You can wireless connect to your mobile phone. Depending on your mobile phone's capabilities, you can transfer phone book data, photos, sound files, etc. or use it as a modem to connect to the Internet. You may also use it for SMS messaging.



Bluetooth-enabled computers or PDAs

You can wireless connect to another computer or PDA and exchange files, share peripherals, or share Internet or network connections. You may also make use of Bluetooth-enabled wireless keyboard or mouse.



Turning ON and Launching Bluetooth Utility

This process can be used to add most Bluetooth devices. See Appendix for complete process.

1. Switch ON the Wireless function if necessary for your model (see switches in Section 3).



2. Press [FN F2] repeatedly until **Wireless LAN ON** or **WLAN & Bluetooth ON** is shown.
- 2b. Or double click the Wireless Console icon on the taskbar and select either the Wireless LAN + Bluetooth or just the Bluetooth.

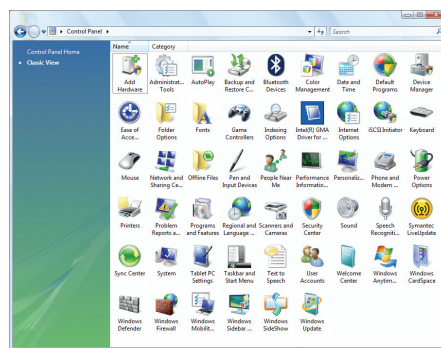
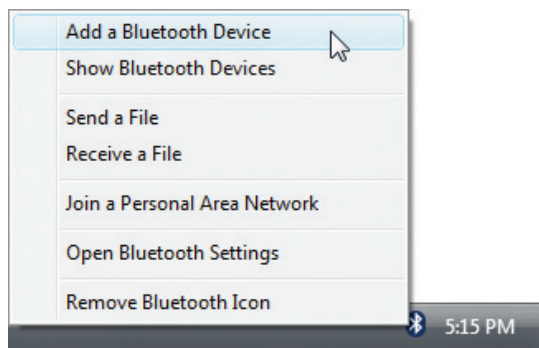

3. Select **Add a Bluetooth Device** on the taskbar menu.
- 3b. Or Launch **Bluetooth Devices** from the Windows Control Panel.

Appendix

Optional Accessories & Connections

Operating System and Software

System BIOS Settings

Common Problems and Solutions

Windows Software Recovery

Glossary

Declarations and Safety Statements

Notebook PC Information



NOTE: Photos and icons in this manual are used for artistic purposes only and do not show what is actually used in the product itself.

Optional Accessories

These items, if desired, come as optional items to complement your Notebook PC.

USB Hub (Optional)

Attaching an optional USB hub will increase your USB ports and allow you to quickly connect or disconnect many USB peripherals through a single cable.



USB Flash Memory Disk

A USB flash memory disk is an optional item that can replace the 1.44MB floppy disk and provide storage up to several hundred megabytes, higher transfer speeds, and greater durability. When used in current operating systems, no drivers are necessary.



USB Floppy Disk Drive

An optional USB-interface floppy disk drive can accept a standard 1.44MB (or 720KB) 3.5-inch floppy diskette.



WARNING! To prevent system failures, use Windows “Safely Remove Hardware” on the taskbar before disconnecting the USB floppy disk drive. Eject the floppy disk before transporting the Notebook PC to prevent damage from shock.

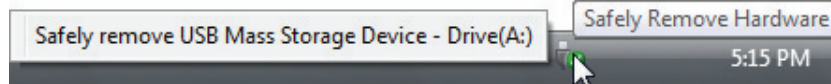

Vehicle Power Adapter

The vehicle power adapter provides a source of power for using the Notebook PC and/or charging the Notebook PC's battery pack while in transit when no AC power is available. This product is an essential tool for today's mobile professional. Your purchase will enhance the power, performance, and versatility of your portable computer while traveling on the road or on the sea. The Vehicle Power Adapter can be used in vehicles or boats using a standard cigarette lighter socket. The Vehicle Power Adapter accepts input ranges from 10.8VDC (Volts - Direct Current) to 16VDC and provides 19VDC up to 120W (Watts).



Optional Connections

These items, if desired, may be purchased from third-parties.

• USB Keyboard and Mouse

Attaching an external USB keyboard will allow data entry to be more comfortable. Attaching an external USB mouse will allow Windows navigation to be more comfortable. Both the external USB keyboard and mouse will work simultaneously with the Notebook PC's built-in keyboard and touchpad.

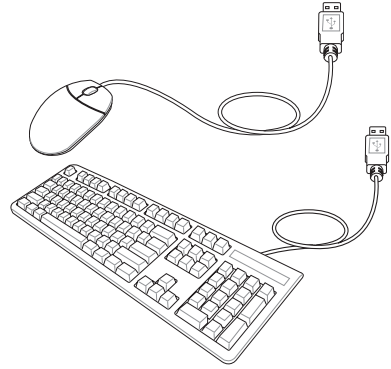

• Printer Connection

One or more USB printers can be simultaneously used on any USB port or USB hub.

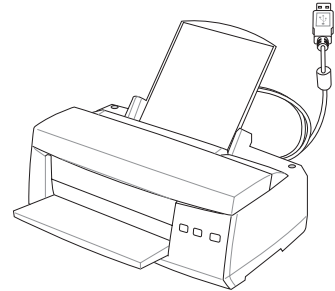

A Appendix

Bluetooth Mouse Setup (optional)

This process can be used to add most Bluetooth devices in Windows operating system.

1. Switch ON the Wireless Function if necessary for your model (see switches in Section 3).



2. Press [FN F2] repeatedly until **Wireless LAN ON** or **WLAN & Bluetooth ON** is shown.

- 2b. Or double click the **Wireless Console** icon on the taskbar and select either the **Wireless LAN + Bluetooth** or just the **Bluetooth**.

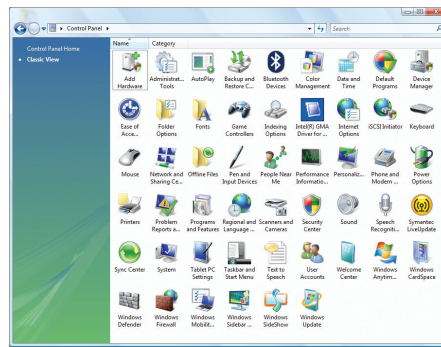
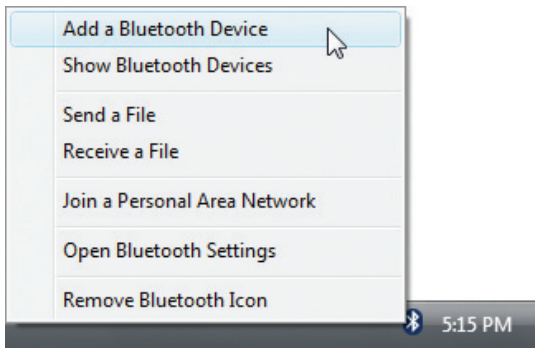

3. Select **Add a Bluetooth Device** on the taskbar menu.

- 3b. Or Launch **Bluetooth Devices** from the Windows Control Panel.

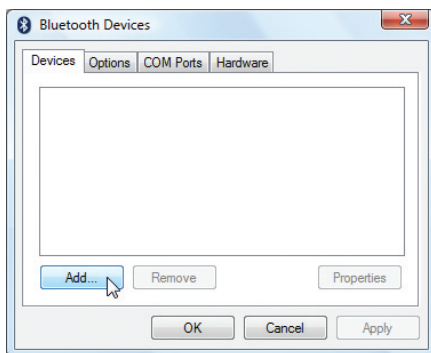

- 3c. If launched from the Control Panel, click **Add** from this screen.

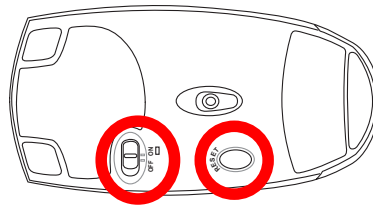

4. Prepare the Bluetooth mouse.

- Install two “AA” batteries.
- Turn ON the power switch on the bottom of the mouse. The bottom sensor should glow red.
- Push the “RESET” button on the bottom of the Bluetooth mouse.



5. Click **Next** when the Bluetooth mouse is ready.

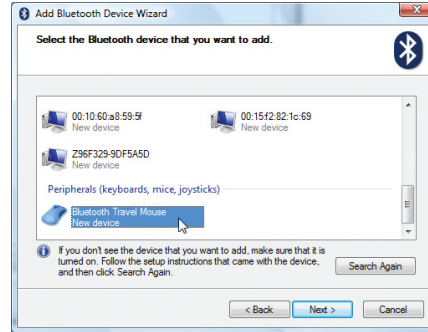

6. A list of nearby Bluetooth devices will be shown. Select the Bluetooth mouse and click **Next**.

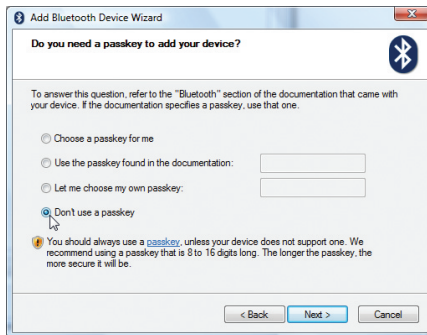

7. Select “Don’t use a passkey” and click **Next**.

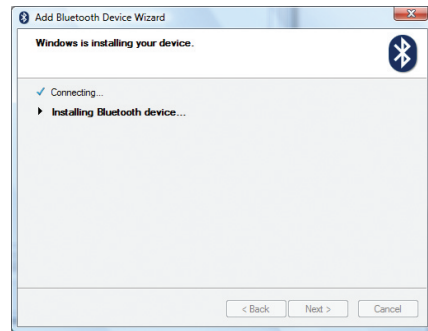

8. Wait while the Bluetooth mouse is being added.

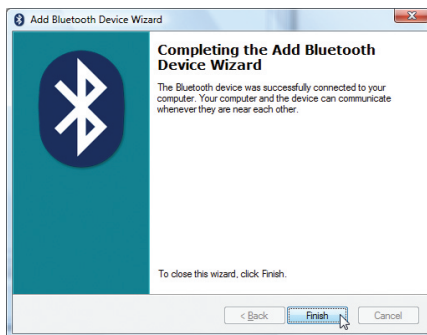

9. Click **Finish** when adding is complete.

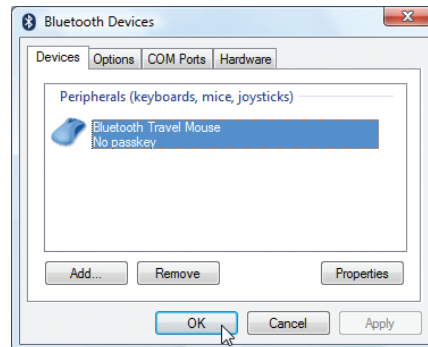

10. You will see your device in the window. You can also add or remove Bluetooth devices here.



Note: “RESET” may be necessary after changing batteries. Repeat steps if necessary.

Operating System and Software

This Notebook PC may offer (depending on territory) its customers the choice of a pre-installed **Microsoft Windows** operating system. The choices and languages will depend on the territory. The levels of hardware and software support may vary depending on the installed operating system. The stability and compatibility of other operating systems cannot be guaranteed.

Support Software

This Notebook PC comes with a support disc that provides BIOS, drivers and applications to enable hardware features, extend functionality, help manage your Notebook PC, or add functionality not provided by the native operating system. If updates or replacement of the support disc is necessary, contact your dealer for web sites to download individual software drivers and utilities.



The support disc contains all drivers, utilities and software for all popular operating systems including those that have been pre-installed. The support disc does not include the operating system itself. The support disc is necessary even if your Notebook PC came pre-configured in order to provide additional software not included as part of the factory pre-install.

A recovery disc is optional and includes an image of the original operating system installed on the hard drive at the factory. The recovery disc provides a comprehensive recovery solution that quickly restores the Notebook PC's operating system to its original working state provided that your hard disk drive is in good working order. Contact your retailer if you require such a solution.



Note: Some of the Notebook PC's components and features may not work until the device drivers and utilities are installed.

System BIOS Settings

Boot Device

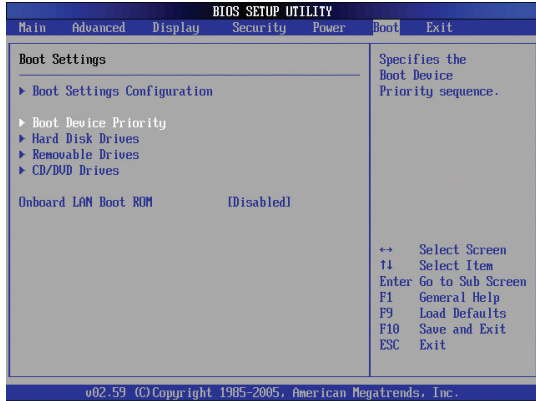

1. On the **Boot** screen, select **Boot Device Priority**.

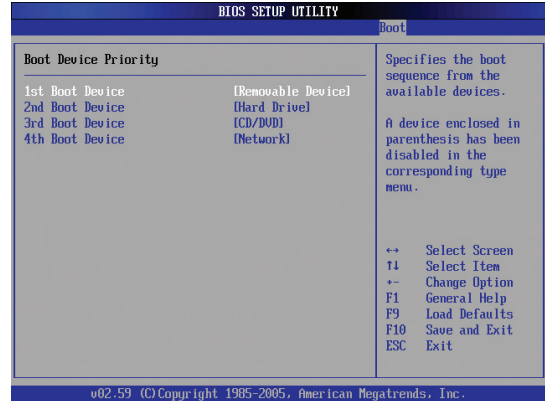

2. Select each item and press **[Enter]** to select a device.

Security Setting



1. On the **Security** screen, select **Change Supervisor** or **Change User Password**.



2. Type in a password and press **[Enter]**.



3. Re-type the password and press **[Enter]**.



4. Password is then set.

To clear the password:



1. Leave the password field blank and press **[Enter]**.



2. Password is then cleared.

System BIOS Settings (cont.)

Password Check

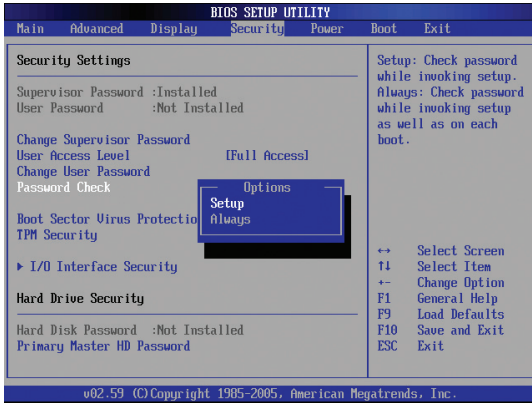

Select whether to ask for a password during bootstrap (Always) or only when entering the BIOS setup utility (Setup).

User Access Level

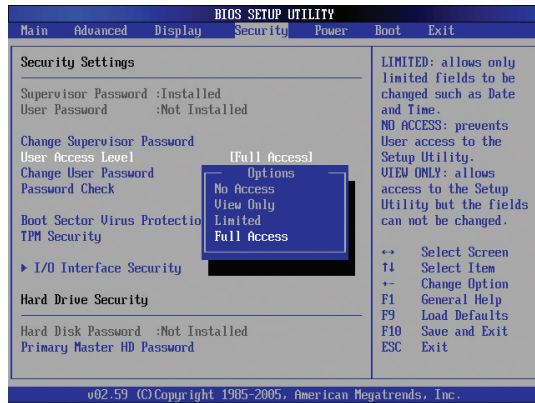

Select the level of access to allow the "User Password" to have in the BIOS setup utility.

Save Changes

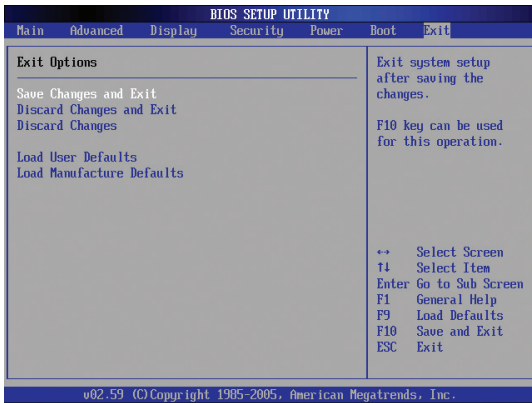

If you want to keep your configuration settings, you must save changes before exiting the BIOS setup utility.



If you want to restore default settings, choose **Load Manufacture Defaults**. You must then save changes to keep the manufacture default settings.

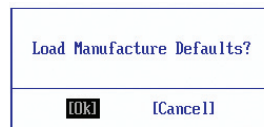

Common Problems and Solutions

Hardware Problem - Optical Disc

The optical disc drive is not able to read or write discs.

1. Update the BIOS to the latest version and try again.
2. If updating the BIOS does not help, try better quality discs and try again.
3. If the problem still exist, contact your local service center and ask an engineer for assistance.

Unknown Reason - System Unstable

Cannot wake up from the hibernation.

1. Remove upgraded parts (RAM, HDD, WLAN, BT) if they were installed after purchase.
2. If not the case, try MS System Restore to an earlier date.
3. If problem still persists, try restoring your system using the recovery partition or DVD.
(NOTE: You must backup all your data to another location before recovering.)
4. If the problem still exist, contact your local service center and ask an engineer for assistance.

Hardware Problem - Keyboard / Hotkey

The Hotkey (FN) is disabled.

- A. Reinstall the “ATK0100” driver from the driver CD or download it from the ASUS website.

Hardware Problem - Built-in Camera

The built-in camera does not work correctly.

1. Check “Device Manager” to see if there are any problems.
2. Try reinstalling the webcam driver to solve the problem.
3. If the problem is not solved, update the BIOS to the latest version and try again.
4. If the problem still exist, contact your local service center and ask an engineer for assistance.

Hardware Problem - Battery

Battery maintenance.

1. Register the Notebook PC for a one-year-warranty using the following website:
<http://member.asus.com/login.aspx?SLanguage=en-us>
2. Do NOT remove the battery pack while using the Notebook PC with the AC adaptor to prevent damage caused by the accidental power loss. The ASUS battery pack has protection circuitry to prevent over-charging so it will not damage the battery pack if it is left in the Notebook PC.
3. Store the battery pack in a dry location with temperatures between 10°C and 30°C if you will not be using it for a long time. It is strongly recommended that you charge the battery pack every three months.

Common Problems and Solutions (Cont.)

Hardware Problem - Power ON/OFF Error

I cannot power ON the Notebook PC.

Diagnostics:

1. Power On by Battery only? (Y = 2, N = 4)
2. Able to see BIOS (ASUS Logo)? (Y = 3, N = A)
3. Able to load the OS? (Y = B, N = A)
4. Adapter power LED ON? (Y = 5, N = C)
5. Power ON by Adapter only? (Y = 6, N = A)
6. Able to see BIOS (ASUS Logo)? (Y = 7, N = A)
7. Able to load the OS? (Y = D, N = A)

Symptom & Solutions:

- A. Problem might be in the MB, HDD, or NB; visit a local service center for assistance.
- B. Problem caused by the operating system, try restoring your system using the recovery partition or disc. **(IMPORTANT: You must backup all your data to another location before recovering.)**
- C. Adapter problem; check the power cord connections, otherwise visit a local service center for replacement.
- D. Battery problem; please check the battery contacts, otherwise visit a local service center for repair.

Mechanical Problem - FAN / Thermal

Why is the cooling fan always ON and the temperature high?

1. Make sure that the FAN works when the CPU temperature is high and check whether there is air flow from the main air vent.
2. If you have many applications running (see taskbar), close them to decrease system load.
3. The problem may also be caused by some viruses, use anti-virus software to detect them.
4. If none of the above help, try restoring your system using the recovery partition or DVD. **(IMPORTANT: You must backup all your data to another location before recovering.)**
(CAUTION: Do not connect to the Internet before you have installed an anti-virus software and Internet firewall to protect yourself from viruses.)

Service - Specification, function, price

How to check whether a Notebook PC is equipped with a wireless card?

- A. Enter **Control Panel -> Device Manager**. You will see whether the Notebook PC has a WLAN card under the "Network Adapter" item.

Common Problems and Solutions (Cont.)

Software Problem - ASUS bundled software

When I power ON the Notebook PC, there will be an “Open policy file error” message.

- A. Reinstall the latest version “Power4 Gear” utility to solve your problem. It is available on the ASUS website.

Unknown Reason - Blue screen with white text

A blue screen with white text appears after system bootup.

1. Remove additional memory. If additional memory was installed after purchase, power OFF, remove the additional memory, and power ON to see if the problem is due to incompatible memory.
2. Un-install software applications. If you have installed software applications recently, they may not be compatible with your system. Try to un-install them in Windows Safe Mode.
3. Check your system for viruses.
4. Update the BIOS to the latest version with WINFLASH in Windows or AFLASH in DOS mode. These utilities and BIOS files can be downloaded from the ASUS website. (WARNING: Make sure your Notebook PC does not loose power during the BIOS flashing process.)
5. If problem still cannot be solved, use the recovery process to reinstall your entire system. **(IMPORTANT: You must backup all your data to another location before recovering.)** (CAUTION: Do not connect to the Internet before you have installed an anti-virus software and Internet firewall to protect yourself from viruses.) (NOTE: Make sure that you install the “Intel INF Update” and “ATKACPI” drivers first so that hardware devices can be recognized.)
6. If the problem still exist, contact your local service center and ask an engineer for assistance.

Software Problem - BIOS

Updating the BIOS.

1. Please verify the Notebook PC's exact model and download the latest BIOS file for your model from the ASUS website.
2. Use the "WINFLASH" utility to update your BIOS. The utility can be found in your Driver & Utility CD that came with your Notebook PC.
3. Extract the BIOS file to a temporary location (such as the root in C:\)
4. Click **Start | All Programs | ASUS Utility | WINFLASH | WINFLASH**
 - a. Select the new BIOS image file.
 - b. Confirm the selected BIOS information. Check the model, version, and data.
 - c. Click **Flash** to initialize the BIOS updating procedure.
 - d. Click **Exit** when procedure completes.
 - e. Reboot the system. Assuming that you have successfully flashed the BIOS file, press [F2] to enter BIOS setup page when the ASUS logo appears during system boot-up.
 - f. After entering BIOS setup page, go to **Exit** page and choose **Load Manufacture Defaults**. Then select **Save and Exit** and reboot the system again.
 - g. The BIOS flash procedure is now complete.



You can also use the "Easy Flash" function on the Advanced page of the BIOS Setup Utility. Follow the instructions shown.



You must "Load Manufacture Defaults" after updating (flashing) the BIOS.

Common Problems and Solutions (Cont.)



Norton
Internet
Security



Symantec's Norton Internet Security (NIS)

1. Sometimes NIS will show an alert to stop a Trojan virus from a local IP address.

This problem can be solved by making sure the virus definition file is the latest one and regularly updating the virus definition file.

2. Reinstalling fails at the “Information Wizard” after uninstalling Norton Antivirus.

Make sure NIS has been uninstalled from your computer, reboot your system, install NIS again, use “Live Update” and update the virus definition file.

3. Norton accidentally blocks desired web pages or reduces download speeds.

Change the security configuration to a lower level. NIS scans virus while downloading data so network speed will be decreased.

4. Cannot login to MSN or Yahoo messenger services.

Make sure NIS has been updated and also update the Windows system by using “Windows Update”. If the problem still exist, try:

1. Open NIS 200x by clicking on the NIS icon in your system tray.
2. Open “Norton AntiVirus” in “Options” menu.
3. Click on “Instant Messenger” uncheck “MSN/Windows Messenger” from “Which Instant messengers to protect.”

5. NIS is damaged and need reinstalling.

NIS is located in the provided disc in the “NIS200x” folder (x is the version number).

6. The “Start firewall when system is booted” option is selected but it takes about one minute to startup the firewall every time I enter Windows. Windows is not responsive during this time.

If NIS firewall reduces your system speed to an intolerable level, deselect that option.

7. Much of my system speed has been reduced by NIS.

NIS will reduce your system speed (both booting and running performance) if you are using NIS's full protection functions, NIS scans and tracks all data in the background. You can speed up your system by stopping NIS's auto scan functions in system bootup. You can then scan virus manually when your computer is not in use.

8. Cannot uninstall NIS.

Go to **Control Panel | Add or Remove Programs**. Look for “Norton Internet Security 200x (Symantec Corporation)”. Click **Change/Remove** and choose **Remove All** to uninstall NIS.

Common Problems and Solutions (Cont.)

9. Windows Firewall must be stopped before installing “Norton Internet Security” or “Norton Personal Firewall”. How to stop Windows Firewall:

1. Click **Start** and then **Control Panel**.
2. You will have one of two control panels. Click on the **Security Center** icon.
3. Click on the **Windows Firewall** icon beneath the status updates.
4. Click **Off** and then click **OK**.

10. Why is the “Privacy Control” icon showing ‘x’?

Turn off **Privacy Control** from “Status & Settings”.

11. Insufficient privilege message.

Many settings, including disabling or uninstalling NIS, require you to be logged into Windows with Administrator privileges. Log Off and switch to a user account with Administrator privileges.

Windows Vista Software Recovery

Using Hard Disk Partition

The Recovery Partition includes an image of the operating system, drivers, and utilities installed on your Notebook PC at the factory. The Recovery Partition provides a comprehensive recovery solution that quickly restores your Notebook PC's software to its original working state, provided that your hard disk drive is in good working order. Before using the Recovery Partition, copy your data files (such as Outlook PST files) to floppy disks or to a network drive and make note of any customized configuration settings (such as network settings).

About the Recovery Partition

The Recovery Partition is a space reserved on your hard disk drive used to restore the operating system, drivers, and utilities installed on your Notebook PC at the factory.



IMPORTANT: Do not delete the partition named “RECOVERY”. The Recovery Partition is created at the factory and cannot be restored by the user if deleted. Take your Notebook PC to an authorized ASUS service center if you have problems with the recovery process.

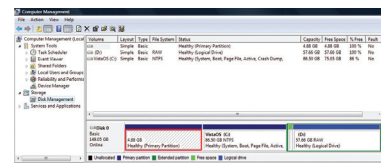

Using the Recovery Partition:

1. Press [F9] during bootup (requires a Recovery Partition)
2. Press [Enter] to select **Windows Setup [EMS Enabled]**
3. Read the “ASUS Preload Wizard” screen and click **Next**.
4. Select a partition option and click **Next**. Partition options:

Recover Windows to first partition only.

This option will delete only the first partition, allowing you to keep other partitions, and create a new system partition as drive “C”.

Recover Windows to entire HD.

This option will delete all partitions from your hard disk drive and create a new system partition as drive “C”.

Recover Windows to entire HD with 2 partition.

This option will delete all partitions from your hard drive and create two new partitions “C” (60%) and “D” (40%).

5. Follow the on-screen instructions to complete the recovery process.



NOTE: Please visit www.asus.com for updated drivers and utilities.

Windows Vista Software Recovery (Cont.) Using DVD (on selected models)

The Recovery DVD includes an image of the operating system, drivers, and utilities installed on your Notebook PC at the factory. The Recovery DVD provides a comprehensive recovery solution that quickly restores your Notebook PC's software to its original working state, provided that your hard disk drive is in good working order. Before using the Recovery DVD, copy your data files (such as Outlook PST files) to floppy disks or to a network drive and make note of any customized configuration settings (such as network settings).

Using the Recovery DVD:

1. Insert the Recovery DVD into the optical drive (Notebook PC needs to be powered ON).
2. Restart the Notebook PC and press <Esc> on bootup and select the optical drive (may be labeled as "CD/DVD") using the down cursor and press <Enter> to boot from the Recovery DVD.
3. Select a partition option and click **Next**. Partition options:

Recover Windows to first partition only.

This option will delete only the first partition, allowing you to keep other partitions, and create a new system partition as drive "C".

Recover Windows to entire HD.

This option will delete all partitions from your hard disk drive and create a new system partition as drive "C".

Recover Windows to entire HD with 2 partition.

This option will delete all partitions from your hard drive and create two new partitions "C" (60%) and "D" (40%).

4. Follow the on-screen instructions to complete the recovery process.



WARNING: Do not remove the Recovery CD (unless instructed to do so) during the recovery process or else your partitions will be unusable.



NOTE: Please visit www.asus.com for updated drivers and utilities.

 **Glossary****ACPI (Advanced Configuration and Power Management Interface)**

Modern standard for reducing power usage in computers.

APM (Advanced Power Management)

Modern standard for reducing power usage in computers.

AWG (American Wire Gauge)

NOTE: This table is for general reference only and should not be used as a source of the American Wire Gauge standard as this table may not be current or complete.

| Gauge AWG | Diam (mm) | Area (mm ²) | R (ohm/km) | I@3A/mm ² (mA) | Gauge AWG | Diam (mm) | Area (mm ²) | R (ohm/km) | I@3A/mm ² (mA) |
|--------------|--------------|----------------------------|---------------|------------------------------|--------------|--------------|----------------------------|---------------|------------------------------|
| 33 | 0.18 | 0.026 | 676 | 75 | 24 | 0.50 | 0.20 | 87.5 | 588 |
| | 0.19 | 0.028 | 605 | 85 | | 0.55 | 0.24 | 72.3 | 715 |
| 32 | 0.20 | 0.031 | 547 | 93 | | 0.60 | 0.28 | 60.7 | 850 |
| 30 | 0.25 | 0.049 | 351 | 147 | 22 | 0.65 | 0.33 | 51.7 | 1.0 A |
| 29 | 0.30 | 0.071 | 243 | 212 | | 0.70 | 0.39 | 44.6 | 1.16 A |
| 27 | 0.35 | 0.096 | 178 | 288 | | 0.75 | 0.44 | 38.9 | 1.32 A |
| 26 | 0.40 | 0.13 | 137 | 378 | 20 | 0.80 | 0.50 | 34.1 | 1.51 A |
| 25 | 0.45 | 0.16 | 108 | 477 | | 0.85 | 0.57 | 30.2 | 1.70 A |

BIOS (Basic Input/Output System)

BIOS is a set of routines that affect how the computer transfers data between computer components, such as memory, disks, and the display adapter. The BIOS instructions are built into the computer's read-only memory. BIOS parameters can be configured by the user through the BIOS Setup program. The BIOS can be updated using the provided utility to copy a new BIOS file into the EEPROM.

Bit (Binary Digit)

Represents the smallest unit of data used by the computer. A bit can have one of two values: 0 or 1.

Boot

Boot means to start the computer operating system by loading it into system memory. When the manual instructs you to "boot" your system (or computer), it means to turn ON your computer. "Reboot" means to restart your computer. When using Windows 95 or later, selecting "Restart" from "Start | Shut Down..." will reboot your computer.

Byte (Binary Term)

One byte is a group of eight contiguous bits. A byte is used to represent a single alphanumeric character, punctuation mark, or other symbol.

Clock Throttling

Chipset function which allows the processor's clock to be stopped and started at a known duty cycle. Clock throttling is used for power savings, thermal management, and reducing processing speed.

Glossary (Cont.)

CPU (Central Processing Unit)

The CPU, sometimes called “Processor,” actually functions as the “brain” of the computer. It interprets and executes program commands and processes data stored in memory.

Device Driver

A device driver is a special set of instructions that allows the computer’s operating system to communicate with devices such as VGA, audio, Ethernet, printer, or modem.

DVD

DVD is essentially a bigger, faster CD that can hold video as well as audio and computer data. With these capacities and access rates, DVD discs can provide you with dramatically-enhanced high-color, full-motion videos, better graphics, sharper pictures, and digital audio for a theater-like experience. DVD aims to encompass home entertainment, computers, and business information with a single digital format, eventually replacing audio CD, videotape, laserdisc, CD-ROM, and video game cartridges.

ExpressCard

ExpressCard slot is 26 pins and support one ExpressCard/34mm or one ExpressCard/54mm expansion card. This new interface is faster by using a serial bus supporting USB 2.0 and PCI Express instead of the slower parallel bus used in the PC card slot. (Not compatible with previous PCMCIA cards.)

Hardware

Hardware is a general term referring to the physical components of a computer system, including peripherals such as printers, modems, and pointing devices.

IDE (Integrated Drive Electronics)

IDE devices integrate the drive control circuitry directly on the drive itself, eliminating the need for a separate adapter card (in the case for SCSI devices). UltraDMA/66 or 100 IDE devices can achieve up to 33MB/Sec transfer.

IEEE1394 (1394)

Also known as iLINK (Sony) or FireWire (Apple). 1394 is a high speed serial bus like SCSI but has simple connections and hot-plugging capabilities like USB. The popular 1394a interface has a bandwidth of 400Mbits/sec and can handle up to 63 units on the same bus. The newer 1394b interface can support twice the speed and will appear in future models when peripherals support higher speeds. 1394 is also used in high-end digital equipment and should be marked “DV” for Digital Video port.

Infrared Port (IrDA) (on selected models)

The infrared (IrDA) communication port allows convenient wireless data communication with infrared-equipped devices or computers up to 4Mbits/sec. This allows easy wireless synchronization with PDAs or mobile phones and even wireless printing to printers. Small offices can use IrDA technology to share a printer between several closely placed Notebook PCs and even send files to each other without a network.

 **Glossary (Cont.)****Kensington® Locks**

Kensington® locks (or compatible) allow the Notebook PC to be secured usually using a metal cable and lock that prevent the Notebook PC to be removed from a fixed object. Some security products may also include a motion detector to sound an alarm when moved.

Laser Classifications

As lasers became more numerous and more widely used, the need to warn users of laser hazards became apparent. To meet this need, laser classifications were established. Current classification levels vary from optically safe, requiring no controls (Class 1) to very hazardous, requiring strict controls (Class 4).

CLASS 1: A Class 1 laser or laser system emits levels of optical energy that are eye-safe and consequently require no controls. An example of this class of laser system is the checkout scanning device found in most grocery stores or lasers used in optical drives.

CLASS 2 & CLASS 3A: Class 2 and Class 3A lasers emit visible, continuous-wave (CW) optical radiation levels slightly above the maximum permissible exposure (MPE) level. Although these lasers can cause eye damage, their brightness usually causes observers to look away or blink before eye damage occurs. These lasers have strict administrative controls requiring placement of signs warning personnel not to stare directly into the beam. Class 3A lasers must not be viewed with optically-aided devices.

CLASS 3B: Class 3B lasers, and Class 3A lasers with outputs of 2.5mW, are hazardous to personnel who are within the beam path and look at the beam source directly or by specular reflection. These lasers cannot produce hazardous diffuse reflections. Personnel working with these lasers should wear appropriate protective eye wear during any operation of the laser. Class 3B lasers have both administrative and physical controls to protect personnel. Physical controls include limited access work areas. Administrative controls include special warning signs posted outside the entrances to the laser work spaces and lights outside the entrances that warn personnel when the lasers are in use.

CLASS 4: Class 4 lasers are high-power lasers that will cause damage to unprotected eyes and skin through intra-beam viewing and specular or diffuse reflections. Consequently, no personnel should be in a room where a Class 4 laser is operating without proper eye protection.

PCI Bus (Peripheral Component Interconnect Local Bus)

PCI bus is a specification that defines a 32-bit data bus interface. PCI is a standard widely used by expansion card manufacturers.

POST (Power On Self Test)

When you turn on the computer, it will first run through the POST, a series of software-controlled diagnostic tests. The POST checks system memory, the motherboard circuitry, the display, the keyboard, the diskette drive, and other I/O devices.

Glossary (Cont.)

RAM (Random Access Memory)

RAM (usually just called memory) is the place in a computer where the operating system, application programs, and data in current use are temporarily kept so that they can be quickly reached by the computer's processor instead of having to read from and write to slower storage such as the hard disk or optical disc.

Suspend Mode

In Save-to-RAM (STR) and Save-to-Disk (STD), the CPU clock is stopped and most of the Notebook PC devices are put in their lowest active state. The Notebook PC enters Suspend when the system remains idle for a specified amount of time or manually using the function keys. The time-out setting of both Hard Disk and Video can be set by the BIOS Setup. The Power LED blinks when the Notebook PC is in STR mode. In STD mode, the Notebook PC will appear to be powered OFF.

System Disk

A system disk contains the core file of an operating system and is used to boot up the operating system.

TPM (Trusted Platform Module) (on selected models)

The TPM is a security hardware device on the system board that will hold computer-generated keys for encryption. It is a hardware-based solution that can help avoid attacks by hackers looking to capture passwords and encryption keys to sensitive data. The TPM provides the ability to the PC or Notebook PC to run applications more secure and to make transactions and communication more trustworthy.

Twisted-Pair Cable

The cable used to connect the Ethernet card to a host (generally a Hub or Switch) is called a straight-through Twisted Pair Ethernet (TPE). The end connectors are called RJ-45 connectors, which are not compatible with RJ-11 telephone connectors. If connecting two computers together without a hub in between, a crossover twisted-pair is required.

UltraDMA/66 or 100

UltraDMA/66 or 100 are new specifications to improve IDE transfer rates. Unlike traditional PIO mode, which only uses the rising edge of IDE command signal to transfer data, UltraDMA/66 or 100 uses both rising edge and falling edge.

USB (Universal Serial Bus)

A 4-pin serial peripheral bus that allows plug and play computer peripherals such as keyboard, mouse, joystick, scanner, printer and modem/ISDN to be automatically configured when they are attached physically without having to install drivers or reboot. With USB, the traditional complex cables from back panel of your PC can be eliminated.

Declarations and Safety Statements



DVD-ROM Drive Information

The Notebook PC comes with an optional DVD-ROM drive or a CD-ROM drive. In order to view DVD titles, you must install your own DVD viewer software. Optional DVD viewer software may be purchased with this Notebook PC. The DVD-ROM drive allows the use of both CD and DVD discs.

Regional Playback Information

Playback of DVD movie titles involves decoding MPEG2 video, digital AC3 audio and decryption of CSS protected content. CSS (sometimes called copy guard) is the name given to the content protection scheme adopted by the motion picture industry to satisfy a need to protect against unlawful content duplication.

Although the design rules imposed on CSS licensors are many, one rule that is most relevant is playback restrictions on regionalized content. In order to facilitate geographically staggered movie releases, DVD video titles are released for specific geographic regions as defined in “Region Definitions” below. Copyright laws require that all DVD movies be limited to a particular region (usually coded to the region at which it is sold). While DVD movie content may be released for multiple regions, CSS design rules require that any system capable of playing CSS encrypted content must only be capable of playing one region.



NOTE: The region setting may be changed up to five times using the viewer software, then it can only play DVD movies for the last region setting. Changing the region code after that will require factory resetting which is not covered by warranty. If resetting is desired, shipping and resetting costs will be at the expense of the user.

Region Definitions

Region 1

Canada, US, US Territories

Region 2

Czech, Egypt, Finland, France, Germany, Gulf States, Hungary, Iceland, Iran, Iraq, Ireland, Italy, Japan, Netherlands, Norway, Poland, Portugal, Saudi Arabia, Scotland, South Africa, Spain, Sweden, Switzerland, Syria, Turkey, UK, Greece, Former Yugoslav Republics, Slovakia

Region 3

Burma, Indonesia, South Korea, Malaysia, Philippines, Singapore, Taiwan, Thailand, Vietnam

Region 4

Australia, Caribbean (Except US Territories), Central America, New Zealand, Pacific Islands, South America

Region 5

CIS, India, Pakistan, Rest of Africa, Russia, North Korea

Region 6

China

☐ Internal Modem Compliancy

The Notebook PC with internal modem model complies with JATE (Japan), FCC (US, Canada, Korea, Taiwan), and CTR21. The internal modem has been approved in accordance with Council Decision 98/482/EC for pan-European single terminal connection to the public switched telephone network (PSTN). However due to differences between the individual PSTNs provided in different countries, the approval does not, of itself, give an unconditional assurance of successful operation on every PSTN network termination point. In the event of problems you should contact your equipment supplier in the first instance.

Overview

On 4th August 1998 the European Council Decision regarding the CTR 21 has been published in the Official Journal of the EC. The CTR 21 applies to all non voice terminal equipment with DTMF-dialling which is intended to be connected to the analogue PSTN (Public Switched Telephone Network).

CTR 21 (Common Technical Regulation) for the attachment requirements for connection to the analogue public switched telephone networks of terminal equipment (excluding terminal equipment supporting the voice telephony justified case service) in which network addressing, if provided, is by means of dual tone multifrequency signalling.

Network Compatibility Declaration

Statement to be made by the manufacturer to the Notified Body and the vendor: “This declaration will indicate the networks with which the equipment is designed to work and any notified networks with which the equipment may have inter-working difficulties”

Network Compatibility Declaration

Statement to be made by the manufacturer to the user: “This declaration will indicate the networks with which the equipment is designed to work and any notified networks with which the equipment may have inter-working difficulties. The manufacturer shall also associate a statement to make it clear where network compatibility is dependent on physical and software switch settings. It will also advise the user to contact the vendor if it is desired to use the equipment on another network.”

Up to now the Notified Body of CETECOM issued several pan-European approvals using CTR 21. The results are Europe’s first modems which do not require regulatory approvals in each individual European country.

Non-Voice Equipment

Answering machines and loud-speaking telephones can be eligible as well as modems, fax machines, auto-dialers and alarm systems. Equipment in which the end-to-end quality of speech is controlled by regulations (e.g. handset telephones and in some countries also cordless telephones) is excluded.

Internal Modem Compliancy (Cont.)

This table shows the countries currently under the CTR21 standard.

| <u>Country</u> | <u>Applied</u> | <u>More Testing</u> |
|------------------------------|-----------------------|----------------------------|
| Austria ¹ | Yes | No |
| Belgium | Yes | No |
| Czech Republic | No | Not Applicable |
| Denmark ¹ | Yes | Yes |
| Finland | Yes | No |
| France | Yes | No |
| Germany | Yes | No |
| Greece | Yes | No |
| Hungary | No | Not Applicable |
| Iceland | Yes | No |
| Ireland | Yes | No |
| Italy | Still Pending | Still Pending |
| Israel | No | No |
| Lichtenstein | Yes | No |
| Luxemburg | Yes | No |
| The Netherlands ¹ | Yes | Yes |
| Norway | Yes | No |
| Poland | No | Not Applicable |
| Portugal | No | Not Applicable |
| Spain | No | Not Applicable |
| Sweden | Yes | No |
| Switzerland | Yes | No |
| United Kingdom | Yes | No |

This information was copied from CETECOM and is supplied without liability. For updates to this table, you may visit http://www.cetecom.de/technologies/ctr_21.html

¹ National requirements will apply only if the equipment may use pulse dialling (manufacturers may state in the user guide that the equipment is only intended to support DTMF signalling, which would make any additional testing superfluous).

In The Netherlands additional testing is required for series connection and caller ID facilities.

FCC Federal Communications Commission Statement

This device complies with FCC Rules Part 15. Operation is subject to the following two conditions:

- This device may not cause harmful interference, and
- This device must accept any interference received, including interference that may cause undesired operation.

This equipment has been tested and found to comply with the limits for a class B digital device, pursuant to Part 15 of the Federal Communications Commission (FCC) rules. These limits are designed to provide reasonable protection against harmful interference in a residential installation. This equipment generates, uses, and can radiate radio frequency energy and, if not installed and used in accordance with the instructions, may cause harmful interference to radio communications. However, there is no guarantee that interference will not occur in a particular installation. If this equipment does cause harmful interference to radio or television reception, which can be determined by turning the equipment off and on, the user is encouraged to try to correct the interference by one or more of the following measures:

- Reorient or relocate the receiving antenna.
- Increase the separation between the equipment and receiver.
- Connect the equipment into an outlet on a circuit different from that to which the receiver is connected.
- Consult the dealer or an experienced radio/TV technician for help.



WARNING! The use of a shielded-type power cord is required in order to meet FCC emission limits and to prevent interference to the nearby radio and television reception. It is essential that only the supplied power cord be used. Use only shielded cables to connect I/O devices to this equipment. You are cautioned that changes or modifications not expressly approved by the party responsible for compliance could void your authority to operate the equipment.

(Reprinted from the Code of Federal Regulations #47, part 15.193, 1993. Washington DC: Office of the Federal Register, National Archives and Records Administration, U.S. Government Printing Office.)

CE Mark Warning

This is a Class B product, in a domestic environment, this product may cause radio interference, in which case the user may be required to take adequate measures.

FC FCC Radio Frequency Interference Requirements

This device is restricted to INDOOR USE due to its operation in the 5.15 to 5.25GHz frequency range. FCC requires this product to be used indoors for the frequency range 5.15 to 5.25GHz to reduce the potential for harmful interference to co-channel of the Mobile Satellite Systems.

High power radars are allocated as primary user of the 5.25 to 5.35GHz and 5.65 to 5.85GHz bands. These radar stations can cause interference with and / or damage this device.



IMPORTANT: This device and its antenna(s) must not be co-located or operating in conjunction with any other antenna or transmitter.

FC FCC Radio Frequency (RF) Exposure Caution Statement

This equipment complies with FCC RF exposure limits set forth for an uncontrolled environment. To maintain compliance with FCC RF exposure compliance requirements, please follow operation instructions in the user's manual. This equipment is for operation within 5.15 GHz and 5.25GHz frequency ranges and is restricted to indoor environments only.



FCC Caution: Any changes or modifications not expressly approved by the party responsible for compliance could void the user's authority to operate this equipment. "The manufacturer declares that this device is limited to Channels 1 through 11 in the 2.4GHz frequency by specified firmware controlled in the USA."

R&TTE Directive (1999/5/EC)

The following items were completed and are considered relevant and sufficient for the R&TTE (Radio & Telecommunications Terminal Equipment) directive:

- Essential requirements as in [Article 3]
- Protection requirements for health and safety as in [Article 3.1a]
- Testing for electric safety according to [EN 60950]
- Protection requirements for electromagnetic compatibility in [Article 3.1b]
- Testing for electromagnetic compatibility in [EN 301 489-1] & [EN 301]
- Testing according to [489-17]
- Effective use of the radio spectrum as in [Article 3.2]
- Radio test suites according to [EN 300 328-2]

A Appendix

Wireless Operation Channel for Different Domains

| | | |
|-------------|-----------------|-------------------|
| N. America | 2.412-2.462 GHz | Ch01 through CH11 |
| Japan | 2.412-2.484 GHz | Ch01 through Ch14 |
| Europe ETSI | 2.412-2.472 GHz | Ch01 through Ch13 |

France Restricted Wireless Frequency Bands

Some areas of France have a restricted frequency band. The worst case maximum authorized power indoors are:

- 10mW for the entire 2.4 GHz band (2400 MHz–2483.5 MHz)
- 100mW for frequencies between 2446.5 MHz and 2483.5 MHz

 **NOTE: Channels 10 through 13 inclusive operate in the band 2446.6 MHz to 2483.5 MHz.**

There are few possibilities for outdoor use: On private property or on the private property of public persons, use is subject to a preliminary authorization procedure by the Ministry of Defense, with maximum authorized power of 100mW in the 2446.5–2483.5 MHz band. Use outdoors on public property is not permitted.

In the departments listed below, for the entire 2.4 GHz band:

- Maximum authorized power indoors is 100mW
- Maximum authorized power outdoors is 10mW

Departments in which the use of the 2400–2483.5 MHz band is permitted with an EIRP of less than 100mW indoors and less than 10mW outdoors:

| | | | |
|------------------------|-------------------|-------------------|--------------------------|
| 01 Ain Orientales | 02 Aisne | 03 Allier | 05 Hautes Alpes |
| 08 Ardennes | 09 Ariège | 11 Aude | 12 Aveyron |
| 16 Charente | 24 Dordogne | 25 Doubs | 26 Drôme |
| 32 Gers | 36 Indre | 37 Indre et Loire | 41 Loir et Cher |
| 45 Loiret | 50 Manche | 55 Meuse | 58 Nièvre |
| 59 Nord | 60 Oise | 61 Orne | 63 Puy du Dôme |
| 64 Pyrénées Atlantique | 66 Pyrénées | 67 Bas Rhin | 68 Haut Rhin |
| 70 Haute Saône | 71 Saône et Loire | 75 Paris | 82 Tarn et Garonne |
| 84 Vaucluse | 88 Vosges | 89 Yonne | 90 Territoire de Belfort |
| 94 Val de Marne | | | |

This requirement is likely to change over time, allowing you to use your wireless LAN card in more areas within France. Please check with ART for the latest information (www.art-telecom.fr)

 **NOTE: Your WLAN Card transmits less than 100mW, but more than 10mW.**



UL Safety Notices

Required for UL 1459 covering telecommunications (telephone) equipment intended to be electrically connected to a telecommunication network that has an operating voltage to ground that does not exceed 200V peak, 300V peak-to-peak, and 105V rms, and installed or used in accordance with the National Electrical Code (NFPA 70).

When using the Notebook PC modem, basic safety precautions should always be followed to reduce the risk of fire, electric shock, and injury to persons, including the following:

- **Do not use** the Notebook PC near water, for example, near a bath tub, wash bowl, kitchen sink or laundry tub, in a wet basement or near a swimming pool.
- **Do not use** the Notebook PC during an electrical storm. There may be a remote risk of electric shock from lightning.
- **Do not use** the Notebook PC in the vicinity of a gas leak.

Required for UL 1642 covering primary (non-rechargeable) and secondary (rechargeable) lithium batteries for use as power sources in products. These batteries contain metallic lithium, or a lithium alloy, or a lithium ion, and may consist of a single electrochemical cell or two or more cells connected in series, parallel, or both, that convert chemical energy into electrical energy by an irreversible or reversible chemical reaction.

- **Do not** dispose the Notebook PC battery pack in a fire, as they may explode. Check with local codes for possible special disposal instructions to reduce the risk of injury to persons due to fire or explosion.
- **Do not** use power adapters or batteries from other devices to reduce the risk of injury to persons due to fire or explosion. Use only UL certified power adapters or batteries supplied by the manufacturer or authorized retailers.



Power Safety Requirement

Products with electrical current ratings up to 6A and weighing more than 3Kg must use approved power cords greater than or equal to: H05VV-F, 3G, 0.75mm² or H05VV-F, 2G, 0.75mm².

Nordic Lithium Cautions (for lithium-ion batteries)



CAUTION! Danger of explosion if battery is incorrectly replaced. Replace only with the same or equivalent type recommended by the manufacturer. Dispose of used batteries according to the manufacturer's instructions. (English)



ATTENZIONE! Rischio di esplosione della batteria se sostituita in modo errato. Sostituire la batteria con un una di tipo uguale o equivalente consigliata dalla fabbrica. Non disperdere le batterie nell'ambiente. (Italian)



VORSICHT! Explosionsgetahr bei unsachgemäßen Austausch der Batterie. Ersatz nur durch denselben oder einem vom Hersteller empfohlenem ähnlichen Typ. Entsorgung gebrauchter Batterien nach Angaben des Herstellers. (German)



ADVARSELI! Lithiumbatteri - Eksplosionsfare ved fejlagtig håndtering. Udskiftning må kun ske med batteri af samme fabrikat og type. Levér det brugte batteri tilbage til leverandøren. (Danish)



WARNING! Explosionsfara vid felaktigt batteribyte. Använd samma batterityp eller en ekvivalent typ som rekommenderas av apparattillverkaren. Kassera använt batteri enligt fabrikantens instruktion. (Swedish)



VAROITUS! Paristo voi räjähtää, jos se on virheellisesti asennettu. Vaihda paristo ainoastaan laitevalmistajan suosittellemaan tyyppiin. Hävitä käytetty paristo valmistagan ohjeiden mukaisesti. (Finnish)



ATTENTION! Il y a danger d'explosion s'il y a remplacement incorrect de la batterie. Remplacer uniquement avec une batterie du même type ou d'un type équivalent recommandé par le constructeur. Mettre au rebut les batteries usagées conformément aux instructions du fabricant. (French)



ADVARSEL! Eksplosjonsfare ved feilaktig skifte av batteri. Benytt samme batteritype eller en tilsvarende type anbefalt av apparatfabrikanten. Brukte batterier kasseres i henhold til fabrikantens instruksjoner. (Norwegian)



標準品以外の使用は、危険の元になります。交換品を使用する場合、製造者に指定されるものを使って下さい。製造者の指示に従って処理して下さい。

(Japanese)

Optical Drive Safety Information

Laser Safety Information

Internal or external optical drives sold with this Notebook PC contains a CLASS 1 LASER PRODUCT. Laser classifications can be found in the glossary at the end of this user's manual.



WARNING: Making adjustments or performing procedures other than those specified in the user's manual may result in hazardous laser exposure. Do not attempt to disassemble the optical drive. For your safety, have the optical drive serviced only by an authorized service provider.

Service warning label



CAUTION: INVISIBLE LASER RADIATION WHEN OPEN. DO NOT STARE INTO BEAM OR VIEW DIRECTLY WITH OPTICAL INSTRUMENTS.

CDRH Regulations

The Center for Devices and Radiological Health (CDRH) of the U.S. Food and Drug Administration implemented regulations for laser products on August 2, 1976. These regulations apply to laser products manufactured from August 1, 1976. Compliance is mandatory for products marketed in the United States.



WARNING: Use of controls or adjustments or performance of procedures other than those specified herein or in the laser product installation guide may result in hazardous radiation exposure.

Macrovision Corporation Product Notice

This product incorporates copyright protection technology that is protected by method claims of certain U.S.A. patents and other intellectual property rights owned by Macrovision Corporation and other rights owners. Use of this copyright protection technology must be authorized by Macrovision Corporation, and is intended for home and other limited viewing uses only *unless otherwise authorized by Macrovision Corporation*. Reverse engineering or disassembly is prohibited.

CTR 21 Approval (for Notebook PC with built-in Modem)



Danish

«Udstyret er i henhold til Rådets beslutning 98/482/EF EU-godkendt til at blive opkoblet på de offentlige telefonnet som enkeltforbundet terminal. På grund af forskelle mellem de offentlige telefonnet i de forskellige lande giver godkendelsen dog ikke i sig selv ubetinget garanti for, at udstyret kan fungere korrekt på samtlige nettermineringspunkter på de offentlige telefonnet.
I tilfælde af problemer bør De i første omgang henvende Dem til leverandøren af udstyret.»



Dutch

«Dit apparaat is goedgekeurd volgens Beschikking 98/482/EG van de Raad voor de pan-Europese aansluiting van enkelvoudige eindapparatuur op het openbare geschakelde telefoonnetwerk (PSTN). Gezien de verschillen tussen de individuele PSTN's in de verschillende landen, biedt deze goedkeuring op zichzelf geen onvoorwaardelijke garantie voor een succesvolle werking op elk PSTN-netwerkaansluitpunt.
Neem bij problemen in eerste instantie contact op met de leverancier van het apparaat.»



English

«The equipment has been approved in accordance with Council Decision 98/482/EC for pan-European single terminal connection to the public switched telephone network (PSTN). However, due to differences between the individual PSTNs provided in different countries, the approval does not, of itself, give an unconditional assurance of successful operation on every PSTN network termination point.
In the event of problems, you should contact your equipment supplier in the first instance.»



Finnish

«Tämä laite on hyväksytty neuvoston päätöksen 98/482/EY mukaisesti liitettäväksi yksittäisenä laitteena yleiseen kytkentäiseen puhelinverkkoon (PSTN) EU:n jäsenvaltioissa. Eri maiden yleisten kytkentäisten puhelinverkkojen välillä on kuitenkin eroja, joten hyväksyntä ei sellaisenaan takaa häiriötöntä toimintaa kaikkien yleisten kytkentäisten puhelinverkkojen liittypisteissä.
Ongelmien ilmetessä ottaaak viipymättä yhteyttä laitteen toimittajaan.»



French

«Cet équipement a reçu l'agrément, conformément à la décision 98/482/CE du Conseil, concernant la connexion paneuropéenne de terminal unique aux réseaux téléphoniques publics commutés (RTPC). Toutefois, comme il existe des différences d'un pays à l'autre entre les RTPC, l'agrément en soi ne constitue pas une garantie absolue de fonctionnement optimal à chaque point de terminaison du réseau RTPC.
En cas de problème, vous devez contacter en premier lieu votre fournisseur.»



German

„Dieses Gerät wurde gemäß der Entscheidung 98/482/EG des Rates europaweit zur Anschaltung als einzelne Endeinrichtung an das öffentliche Fernsprechnetz zugelassen. Aufgrund der zwischen den öffentlichen Fernsprechnetzen verschiedener Staaten bestehenden Unterschiede stellt diese Zulassung an sich jedoch keine unbedingte Gewähr für einen erfolgreichen Betrieb des Geräts an jedem Netzabschlusspunkt dar.
Falls beim Betrieb Probleme auftreten, sollten Sie sich zunächst an ihren Fachhändler wenden.“



Greek

«Ο εξοπλισμός έχει εγκριθεί για πανευρωπαϊκή σύνδεση μεμονωμένου τερματικού με το δημόσιο τηλεφωνικό δίκτυο μεταγωγής (PSTN), σύμφωνα με την απόφαση 98/482/ΕΚ του Συμβουλίου. Ωστόσο, επειδή υπάρχουν διαφορές μεταξύ των επιμέρους PSTN που παρέχονται σε διάφορες χώρες, η έγκριση δεν παρέχει απ' αυτής ανεπιφύλακτη εξασφάλιση επιτυχούς λειτουργίας σε κάθε σημείο απόληξης του δικτύου PSTN.
Εάν ανακύβουν προβλήματα, θα πρέπει κατ' αρχάς να απευθύνεστε στον προμηθευτή του εξοπλισμού σας.»



Italian

«La presente apparecchiatura terminale è stata approvata in conformità della decisione 98/482/CE del Consiglio per la connessione paneuropea come terminale singolo ad una rete analogica PSTN. A causa delle differenze tra le reti dei differenti paesi, l'approvazione non garantisce però di per sé il funzionamento corretto in tutti i punti di terminazione di rete PSTN.
In caso di problemi contattare in primo luogo il fornitore del prodotto.»



Portuguese

«Este equipamento foi aprovado para ligação pan-europeia de um único terminal à rede telefónica pública comutada (RTPC) nos termos da Decisão 98/482/CE. No entanto, devido às diferenças existentes entre as RTPC dos diversos países, a aprovação não garante incondicionalmente, por si só, um funcionamento correcto em todos os pontos terminais da rede da RTPC.
Em caso de problemas, deve entrar-se em contacto, em primeiro lugar, com o fornecedor do equipamento.»



Spanish

«Este equipo ha sido homologado de conformidad con la Decisión 98/482/CE del Consejo para la conexión paneuropea de un terminal simple a la red telefónica pública conmutada (RTPC). No obstante, a la vista de las diferencias que existen entre las RTPC que se ofrecen en diferentes países, la homologación no constituye por sí sola una garantía incondicional de funcionamiento satisfactorio en todos los puntos de terminación de la red de una RTPC.
En caso de surgir algún problema, procede ponerse en contacto en primer lugar con el proveedor del equipo.»



Swedish

”Utrustningen har godkänts i enlighet med rådets beslut 98/482/EG för alleuropeisk anslutning som enskild terminal till det allmänt tillgängliga kopplade telenätet (PSTN). På grund av de skillnader som finns mellan telenätet i olika länder utgör godkännandet emellertid inte i sig självt en absolut garanti för att utrustningen kommer att fungera tillfredsställande vid varje telenätsanslutningspunkt.
Om problem uppstår bör ni i första hand kontakta leverantören av utrustningen.”

A Appendix

Notebook PC Information

This page is provided for recording information concerning your Notebook PC for future reference or for technical support. Keep this User's Manual in a secured location if passwords are filled out.

Owner's Name: _____ Owner's Telephone: _____

Manufacturer: _____ Model: _____ Serial Number: _____

Display Size: _____ Resolution: _____ Memory Size: _____

Retailer: _____ Location: _____ Purchase Date: _____

Hard Drive Manufacturer: _____ Capacity: _____

Optical Drive Manufacturer: _____ Type: _____

BIOS Version: _____ Date: _____

Accessories: _____

Accessories: _____

Software

Operating System: _____ Version: _____ Serial Number: _____

Software: _____ Version: _____ Serial Number: _____

Software: _____ Version: _____ Serial Number: _____

Security

Supervisor Name: _____ Supervisor Password: _____

User Name: _____ User Password: _____

Network

User Name: _____ Password: _____ Domain: _____

User Name: _____ Password: _____ Domain: _____

Copyright Information

No part of this manual, including the products and software described in it, may be reproduced, transmitted, transcribed, stored in a retrieval system, or translated into any language in any form or by any means, except documentation kept by the purchaser for backup purposes, without the express written permission of ASUSTeK COMPUTER INC. (“ASUS”).

ASUS PROVIDES THIS MANUAL “AS IS” WITHOUT WARRANTY OF ANY KIND, EITHER EXPRESS OR IMPLIED, INCLUDING BUT NOT LIMITED TO THE IMPLIED WARRANTIES OR CONDITIONS OF MERCHANTABILITY OR FITNESS FOR A PARTICULAR PURPOSE. IN NO EVENT SHALL ASUS, ITS DIRECTORS, OFFICERS, EMPLOYEES OR AGENTS BE LIABLE FOR ANY INDIRECT, SPECIAL, INCIDENTAL, OR CONSEQUENTIAL DAMAGES (INCLUDING DAMAGES FOR LOSS OF PROFITS, LOSS OF BUSINESS, LOSS OF USE OR DATA, INTERRUPTION OF BUSINESS AND THE LIKE), EVEN IF ASUS HAS BEEN ADVISED OF THE POSSIBILITY OF SUCH DAMAGES ARISING FROM ANY DEFECT OR ERROR IN THIS MANUAL OR PRODUCT.

Products and corporate names appearing in this manual may or may not be registered trademarks or copyrights of their respective companies, and are used only for identification or explanation and to the owners’ benefit, without intent to infringe.

SPECIFICATIONS AND INFORMATION CONTAINED IN THIS MANUAL ARE FURNISHED FOR INFORMATIONAL USE ONLY, AND ARE SUBJECT TO CHANGE AT ANY TIME WITHOUT NOTICE, AND SHOULD NOT BE CONSTRUED AS A COMMITMENT BY ASUS. ASUS ASSUMES NO RESPONSIBILITY OR LIABILITY FOR ANY ERRORS OR INACCURACIES THAT MAY APPEAR IN THIS MANUAL, INCLUDING THE PRODUCTS AND SOFTWARE DESCRIBED IN IT.

Copyright © 2007 ASUSTeK COMPUTER INC. All Rights Reserved.

Limitation of Liability

Circumstances may arise where because of a default on ASUS’ part or other liability, you are entitled to recover damages from ASUS. In each such instance, regardless of the basis on which you are entitled to claim damages from ASUS, ASUS is liable for no more than damages for bodily injury (including death) and damage to real property and tangible personal property; or any other actual and direct damages resulted from omission or failure of performing legal duties under this Warranty Statement, up to the listed contract price of each product.

ASUS will only be responsible for or indemnify you for loss, damages or claims based in contract, tort or infringement under this Warranty Statement.

This limit also applies to ASUS’ suppliers and its reseller. It is the maximum for which ASUS, its suppliers, and your reseller are collectively responsible.

UNDER NO CIRCUMSTANCES IS ASUS LIABLE FOR ANY OF THE FOLLOWING: (1) THIRD-PARTY CLAIMS AGAINST YOU FOR DAMAGES; (2) LOSS OF, OR DAMAGE TO, YOUR RECORDS OR DATA; OR (3) SPECIAL, INCIDENTAL, OR INDIRECT DAMAGES OR FOR ANY ECONOMIC CONSEQUENTIAL DAMAGES (INCLUDING LOST PROFITS OR SAVINGS), EVEN IF ASUS, ITS SUPPLIERS OR YOUR RESELLER IS INFORMED OF THEIR POSSIBILITY.

Service and Support

Visit our multi-language web site at <http://support.asus.com>