

ASUS® K7V

Slot A Motherboard

USER'S MANUAL

USER'S NOTICE

No part of this manual, including the products and software described in it, may be reproduced, transmitted, transcribed, stored in a retrieval system, or translated into any language in any form or by any means, except documentation kept by the purchaser for backup purposes, without the express written permission of ASUSTeK COMPUTER INC. ("ASUS").

ASUS PROVIDES THIS MANUAL "AS IS" WITHOUT WARRANTY OF ANY KIND, EITHER EXPRESS OR IMPLIED, INCLUDING BUT NOT LIMITED TO THE IMPLIED WARRANTIES OR CONDITIONS OF MERCHANTABILITY OR FITNESS FOR A PARTICULAR PURPOSE. IN NO EVENT SHALL ASUS, ITS DIRECTORS, OFFICERS, EMPLOYEES OR AGENTS BE LIABLE FOR ANY INDIRECT, SPECIAL, INCIDENTAL, OR CONSEQUENTIAL DAMAGES (INCLUDING DAMAGES FOR LOSS OF PROFITS, LOSS OF BUSINESS, LOSS OF USE OR DATA, INTERRUPTION OF BUSINESS AND THE LIKE), EVEN IF ASUS HAS BEEN ADVISED OF THE POSSIBILITY OF SUCH DAMAGES ARISING FROM ANY DEFECT OR ERROR IN THIS MANUAL OR PRODUCT.

Product warranty or service will not be extended if: (1) the product is repaired, modified or altered, unless such repair, modification or alteration is authorized in writing by ASUS; or (2) the serial number of the product is defaced or missing.

Products and corporate names appearing in this manual may or may not be registered trademarks or copyrights of their respective companies, and are used only for identification or explanation and to the owners' benefit, without intent to infringe.

- AMD, Athlon™, K7, and/or combinations thereof are trademarks of Advanced Micro Devices, Inc.
- VIA is a trademark of VIA Technologies, Inc.
- Windows and MS-DOS are registered trademarks of Microsoft Corporation.
- Adobe and Acrobat are registered trademarks of Adobe Systems Incorporated.
- Trend and ChipAwayVirus are trademarks of Trend Micro, Inc.

The product name and revision number are both printed on the product itself. Manual revisions are released for each product design represented by the digit before and after the period of the manual revision number. Manual updates are represented by the third digit in the manual revision number.

For previous or updated manuals, BIOS, drivers, or product release information, contact ASUS at <http://www.asus.com.tw> or through any of the means indicated on the following page.

SPECIFICATIONS AND INFORMATION CONTAINED IN THIS MANUAL ARE FURNISHED FOR INFORMATIONAL USE ONLY, AND ARE SUBJECT TO CHANGE AT ANY TIME WITHOUT NOTICE, AND SHOULD NOT BE CONSTRUED AS A COMMITMENT BY ASUS. ASUS ASSUMES NO RESPONSIBILITY OR LIABILITY FOR ANY ERRORS OR INACCURACIES THAT MAY APPEAR IN THIS MANUAL, INCLUDING THE PRODUCTS AND SOFTWARE DESCRIBED IN IT.

Copyright © 2000 ASUSTeK COMPUTER INC. All Rights Reserved.

Product Name: **K7V**
Manual Revision: **1.01 E533**
Release Date: **April 2000**

ASUS CONTACT INFORMATION

ASUSTeK COMPUTER INC. (Asia-Pacific)

Marketing

Address: 150 Li-Te Road, Peitou, Taipei, Taiwan 112
Telephone: +886-2-2894-3447
Fax: +886-2-2894-3449
Email: info@asus.com.tw

Technical Support

MB/Others (Tel): +886-2-2890-7121 (English)
Notebook (Tel): +886-2-2890-7122 (English)
Desktop/Server (Tel): +886-2-2890-7123 (English)
Fax: +886-2-2895-9254
Email: tsd@asus.com.tw
WWW: www.asus.com.tw
FTP: ftp.asus.com.tw/pub/ASUS

ASUS COMPUTER INTERNATIONAL (America)

Marketing

Address: 6737 Mowry Avenue, Mowry Business Center, Building 2
Newark, CA 94560, USA
Fax: +1-510-608-4555
Email: tmd1@asus.com

Technical Support

Fax: +1-510-608-4555
Email: tsd@asus.com
WWW: www.asus.com
FTP: ftp.asus.com/Pub/ASUS

ASUS COMPUTER GmbH (Europe)

Marketing

Address: Harkortstr. 25, 40880 Ratingen, BRD, Germany
Fax: +49-2102-442066
Email: sales@asuscom.de (for marketing requests only)

Technical Support

Hotline: MB/Others: +49-2102-9599-0 Notebook: +49-2102-9599-10
Fax: +49-2102-9599-11
Support (Email): www.asuscom.de/de/support (for online support)
WWW: www.asuscom.de
FTP: ftp.asuscom.de/pub/ASUSCOM

CONTENTS

1. INTRODUCTION	7
1.1 How This Manual Is Organized	7
1.2 Item Checklist	7
2. FEATURES	8
2.1 The ASUS K7V Motherboard	8
2.1.1 Specifications	8
2.1.1.1 Optional Components	9
2.1.2 Performance	10
2.1.3 Intelligence (only with optional hardware monitor)	11
2.2 K7V Motherboard Components	12
3. HARDWARE SETUP	14
3.1 K7V Motherboard Layout	14
3.2 Layout Contents	15
3.3 Hardware Setup Procedure	17
3.4 Motherboard Settings	17
3.5 System Memory (DIMM)	22
3.5.1 General DIMM Notes	22
3.5.2 DIMM Memory Installation	23
3.6 Central Processing Unit (CPU)	25
3.6.1 Quick CPU Installation Procedure	25
3.6.2 Attaching the Heatsink	26
3.6.3 Installing the Universal Retention Mechanism	26
3.6.4 Installing the Processor	26
3.6.5 Removing the Processor	28
3.6.6 Smart Thermal Solutions	29
3.6.7 Recommended Heatsinks for Slot A Processors	30
3.7 Expansion Cards	31
3.7.1 Expansion Card Installation Procedure	31
3.7.2 Assigning IRQs for Expansion Cards	31
3.7.3 Accelerated Graphics Port Pro (AGP Pro)	33
3.7.4 Audio Modem Riser (AMR) Slot	33
3.8 External Connectors	35
3.9 Starting Up the First Time	47
4. BIOS SETUP	49
4.1 Managing and Updating Your BIOS	49
4.1.1 Upon First Use of the Computer System	49
4.1.2 Updating BIOS Procedures	50

CONTENTS

4.2	BIOS Setup Program	53
4.2.1	BIOS Menu Bar	54
4.2.2	Legend Bar	54
4.3	Main Menu	56
4.3.1	Primary & Secondary Master/Slave	57
4.3.2	Keyboard Features	60
4.4	Advanced Menu	62
4.4.1	Chip Configuration	65
4.4.2	I/O Device Configuration	67
4.4.3	PCI Configuration	70
4.4.4	Shadow Configuration	73
4.5	Power Menu	74
4.5.1	Power Up Control	76
4.5.2	Hardware Monitor	78
4.6	Boot Menu	79
4.7	Exit Menu	81
5.	SOFTWARE SETUP	83
5.1	Operating Systems	83
5.1.1	Windows 98 First Time Installation	83
5.2	K7V Series Motherboard Support CD	84
5.3	Registry patch for VIA Chipset	85
5.4	VIA PCI IRQ Routing Miniport Driver	86
5.5	AUDIO Driver (only with onboard audio option)	87
5.6	PC-cillin 98	88
5.7	Acrobat Reader Vx.x	89
5.8	IDE Driver	90
5.9	AGP Miniport Driver	91
5.10	ASUS PC Probe x	92
5.11	YAMAHA XGStudio (only with onboard audio option)	93
5.12	Uninstalling Programs	94
6.	SOFTWARE REFERENCE	95
6.1	ASUS PC Probe	95
6.2	YAMAHA XGStudio	100
7.	APPENDIX	103
7.1	PCI-L101 Fast Ethernet Card	103
7.2	Modem Riser	105
7.3	Glossary	107

FCC & DOC COMPLIANCE

Federal Communications Commission Statement

This device complies with FCC Rules Part 15. Operation is subject to the following two conditions:

- This device may not cause harmful interference, and
- This device must accept any interference received, including interference that may cause undesired operation.

This equipment has been tested and found to comply with the limits for a Class B digital device, pursuant to Part 15 of the FCC Rules. These limits are designed to provide reasonable protection against harmful interference in a residential installation. This equipment generates, uses and can radiate radio frequency energy and, if not installed and used in accordance with manufacturer's instructions, may cause harmful interference to radio communications. However, there is no guarantee that interference will not occur in a particular installation. If this equipment does cause harmful interference to radio or television reception, which can be determined by turning the equipment off and on, the user is encouraged to try to correct the interference by one or more of the following measures:

- Re-orient or relocate the receiving antenna.
- Increase the separation between the equipment and receiver.
- Connect the equipment to an outlet on a circuit different from that to which the receiver is connected.
- Consult the dealer or an experienced radio/TV technician for help.

WARNING! Any changes or modifications to this product not expressly approved by the manufacturer could void any assurances of safety or performance and could result in violation of Part 15 of the FCC Rules.

Reprinted from the Code of Federal Regulations #47, part 15.193, 1993. Washington DC: Office of the Federal Register, National Archives and Records Administration, U.S. Government Printing Office.

Canadian Department of Communications Statement

This digital apparatus does not exceed the Class B limits for radio noise emissions from digital apparatus set out in the Radio Interference Regulations of the Canadian Department of Communications.

This Class B digital apparatus complies with Canadian ICES-003.

Cet appareil numérique de la classe B est conforme à la norme NMB-003 du Canada.

1. INTRODUCTION

1.1 How This Manual Is Organized

This manual is divided into the following sections:

- | | |
|-----------------------|--|
| 1. INTRODUCTION | Manual information and checklist |
| 2. FEATURES | Product information and specifications |
| 3. HARDWARE SETUP | Instructions on setting up the motherboard |
| 4. BIOS SETUP | Instructions on setting up the BIOS software |
| 5. SOFTWARE SETUP | Instructions on setting up the included software |
| 6. SOFTWARE REFERENCE | Reference material for the included software |
| 7. APPENDIX | Optional items and general reference |

1.2 Item Checklist

Check that your package is complete. If you discover damaged or missing items, please contact your retailer.

1.2.1 Motherboard

- (1) ASUS Motherboard
- (1) Universal Retention Mechanism
- (1) ASUS 2-port USB Connector Set
- (1) 40-pin 80-conductor ribbon cable for internal UltraDMA/66 or UltraDMA/33 IDE drives
- (1) Ribbon cable for master and slave IDE drives
- (1) Ribbon cable for (1) 3.5" floppy disk drive
- (1) Bag of spare jumper caps
- (1) Support CD with drivers and utilities
- (1) This Motherboard User's Manual
- ASUS 3-port USB Connector Set
- ASUS IrDA-compliant infrared module (optional)
- ASUS PCI-L101 Wake-On-LAN 10/100 Fast Ethernet Card (optional)

IMPORTANT: It is strongly recommended that at least a 200-watt (235W for full configuration) ATX power supply be used for this motherboard. Make sure that your ATX power supply can supply at least 20 amperes on the +5-volt lead and at least 10mA (750mA recommended) on the +5-volt standby lead (+5VSB) (see **19 ATX Power Supply Connector** in **3.8 External Connectors**). Your system may become unstable/unreliable and may experience difficulty in powering up if your power supply is inadequate.

2. FEATURES

2.1 The ASUS K7V Motherboard

The ASUS K7V motherboard is carefully designed for the demanding PC user who wants high-performance features in a small package.

2.1.1 Specifications

- **AMD Athlon™ Processor Support:** Supports AMD Athlon™ processors—including 1GHz—designed for the AMD Athlon™ Processor Module (242-pin Slot A).
- **North Bridge System Chipset:** VIA VT8371™ system controller supports a 200MHz Front Side Bus (FSB), supports up to 1.5GB of PC133/PC100 SDRAM/Virtual Channel Memory (VCM) SDRAM, complies with AGP 2.0 specifications for 4X, 2X, and 1X AGP modes and PCI 2.2. bus interface with support for 5 PCI masters. It is optimized to deliver enhanced AMD Athlon™ processor system performance.
- **South Bridge System Chipset:** VIA VT82C686A PCIset with PCI Super I/O integrated peripheral controller supports UltraDMA/66, which allows burst mode data transfer rates of up to 66.6MB/sec.
- **Enhanced ACPI & Anti-Boot Virus BIOS:** Programmable BIOS (Flash EEPROM), offering enhanced ACPI for Windows 98 compatibility, built-in firmware-based virus protection, and autodetection of most devices for virtually automatic setup.
- **PC133/PC100 Memory Support:** Equipped with three DIMM sockets to support PC133/PC100-compliant SDRAMs or VCM SDRAMs (16, 32, 64, 128, 256, 512MB) up to 1.5GB.
- **JumperFree™ Mode:** Allows processor settings and easy overclocking of frequency and Vcore voltage all through BIOS setup when JumperFree™ mode is enabled. Easy-to-use DIP switches instead of jumpers are included to allow manual adjustment of the processor's external frequency.
- **Thermal Sensor Connector with Optional Sensor:** Accurately detects the CPU temperature with the ASUS Smart Fan when connected to an ASUS P2T-Cable.
- **Super Multi-I/O:** Provides two high-speed UART compatible serial ports and one parallel port with EPP and ECP capabilities.
- **Expansion Slots:** Provides five 32-bit PCI 2.2, one AGP, and one AMR expansion slots. PCI supports up to 133MB/sec maximum throughput. Each PCI slot can support a Bus Master PCI card, such as a SCSI card.
- **Desktop Management Interface (DMI):** Supports DMI through BIOS, which allows hardware to communicate within a standard protocol creating a higher level of compatibility. (Requires DMI-enabled components.)
- **Wake-Up Support:** Supports Wake-On-LAN and Wake-On-Ring.
- **AMR Slot:** Audio Modem Riser (AMR) slot supports a very affordable audio and/or modem riser card.

2. FEATURES

- **AGP Pro Slot:** Supports an Accelerated Graphics Port/AGP Pro card for high performance component level interconnect targeted at 3D graphical display applications using 4X, 2X or 1X mode bus.
- **USB:** Supports up to 4 USB ports, two on the back panel and two midboard, for more peripheral connectivity options.
- **UltraDMA/66 & UltraDMA/33:** Comes with an onboard PCI Bus Master IDE controller with two connectors that support four IDE devices on two channels. Supports UltraDMA/66, UltraDMA/33, PIO Modes 3 & 4 and Bus Master IDE DMA Mode 2, and Enhanced IDE devices, such as DVD-ROM, CD-ROM, CD-R/RW, LS-120, and Tape Backup drives.
- **Smart BIOS:** 2Mb firmware gives a new easy-to-use interface that provides more control and protection over the motherboard. Provides CPU/SDRAM frequency adjustments, and HD/SCSI/ZIP/CD/Floppy/Network boot selection.
- **Color-coded Connectors:** To enhance user accessibility to system components and to meet PC 99 compliancy, major connectors in this motherboard are color-coded.

2.1.1.1 *Optional Components*

The following onboard components are optional at the time of purchase.

- **Onboard Audio:** Hardware AC'97 V2.1 CODEC compliant, 3D sound circuitry, sample rate conversion from 7kHz to 48kHz.
- **Infrared Interface:** Integrated Serial Infrared interface supports an optional remote control package for wireless interfacing with external peripherals, personal gadgets, or an optional remote controller.
- **PC Health Monitoring:** Provides an easy way to examine and manage system status information, such as CPU and system voltages, temperatures, and fan status through the onboard hardware ASIC and the bundled ASUS PC Probe.
- **Additional USB Ports:** For more peripheral connectivity, two additional USB ports are supported midboard.

2. FEATURES

2.1.2 Performance

- **200/133MHz or 200/100MHz Synchronous Host/DRAM Clock Support:** CPU frequency can operate at 200MHz while system memory operates at 133MHz or 100MHz.
- **High-Speed Data Transfer Interface:** This motherboard with its chipset and support for UltraDMA/66 doubles the UltraDMA/33 burst transfer rate to 66.6MB/s. UltraDMA/66 is backward compatible with both DMA/33 and DMA and with existing DMA devices and systems so there is no need to upgrade current EIDE/IDE drives and host systems. (UltraDMA/66 requires a 40-pin 80-conductor cable to be enabled and/or for UltraDMA Mode 4.)
- **Concurrent PCI:** Concurrent PCI allows multiple PCI transfers from PCI master buses to memory to CPU.
- **VCM/SDRAM Optimized Performance:** This motherboard supports a new generation memory, NEC's 64Mb Virtual Channel Memory (VCM) Synchronous Dynamic Random Access Memory (SDRAM), which is compatible to the industry standard SDRAM. The VCM's core design provides up to 50% higher SDRAM speed at reduced power consumption of about 30%. This motherboard also supports standard SDRAM, which increases the data transfer rate (1.064GB/s max using PC133-compliant SDRAMs and 800MB/s max using PC100-compliant SDRAMs).
- **ACPI Ready:** ACPI (Advanced Configuration and Power Interface) provides more Energy Saving Features for future operating systems (OS) supporting OS Direct Power Management (OSPM) functionality. With these features implemented in the OS, PCs can be ready around the clock, yet satisfy all the energy saving standards. To fully utilize the benefits of ACPI, an ACPI-supported OS, such as Windows 98, must be used.
- **New Complyancy:** Both the BIOS and hardware levels of the motherboard meets PC 99 compliancy. The new PC 99 requirements for systems and components are based on the following high-level goals: Support for Plug and Play compatibility and power management for configuring and managing all system components, and 32-bit device drivers and installation procedures for Windows 95/98/NT.

2. FEATURES

2.1.3 Intelligence (only with optional hardware monitor)

- **Fan Status Monitoring and Alarm:** To prevent system overheat and system damage, the CPU, power supply, and system fans can be monitored for RPM and failure. All the fans are set for its normal RPM range and alarm thresholds.
- **Voltage Monitoring and Alert:** Processor and system voltage levels are monitored to ensure stable current to critical motherboard components. Voltage specifications are more critical for future processors, so monitoring is necessary to ensure proper system configuration and management.
- **Auto Fan Off:** The system fans will power off automatically **even in sleep mode**. This function reduces both energy consumption and **system noise**, and is an important feature to implement silent PC systems.
- **Remote Ring On (requires modem):** This allows a computer with this motherboard to be turned on remotely through an internal or external modem. With this feature, users can access their computer from anywhere in the world!

2. FEATURES

2.2 K7V Motherboard Components

See opposite page for locations.

	Location
Processor Support	
Slot A for AMD Athlon™ Processors	1
Frequency Selection DIP Switches	5
Chipsets/Chips	
North Bridge: VIA VT8371™ (System Controller)	2
South Bridge/Super I/O: VIA VT82C686A™ (PCI-to-ISA Bridge)	12
2Mb Programmable Flash EEPROM	9
Main Memory	
Maximum 1.5GB support 3 DIMM Sockets	3
PC133 SDRAM / VC133 VCM support	
Expansion Slots	
5 PCI Slots	18
1 AGP Pro Slot	20
1 Audio Modem Riser (AMR) Slot	16
System I/O	
2 IDE Connectors (UltraDMA33/66 Support)	6
1 Floppy Disk Driver Connector	7
1 Serial COM1 Connector	(Bottom) 24
1 Serial COM2 Connector	(Bottom) 22
1 Parallel Port Connector	(Top) 23
USB Connectors (Port 0 & Port 1)	25
USB Connectors (Ports 2–3; Ports 4–6 optional)	10
1 PS/2 Mouse Connector	(Top) 26
1 PS/2 Keyboard Connector	(Bottom) 26
Audio	
AC'97 V2.1 Audio Codec (optional)	17
Aureal PCI Audio Controller (optional)	14
Digital Audio Interface Header (optional)	15
1 Joystick/MIDI Connector (on audio model only)	(Top) 21
1 Line Out Connector (on audio model only)	(Bottom) 21
1 Line In Connector (on audio model only)	(Bottom) 21
1 Microphone Connector (on audio model only) ...	(Bottom) 21
Network Features	
Wake-On-LAN Connector	8
Wake-On-Ring Connector	13
Hardware Monitoring	
Hardware Monitor Chip	11
3 Fan Power and Speed Monitoring Connectors	
Power	
ATX Power Supply Connector	4
Special Feature	
Onboard LED (Standby Power Warning)	19
Form Factor	
ATX, 305mm x 244mm (12" x 9.6")	

2. FEATURES

K7V Motherboard Component Locations

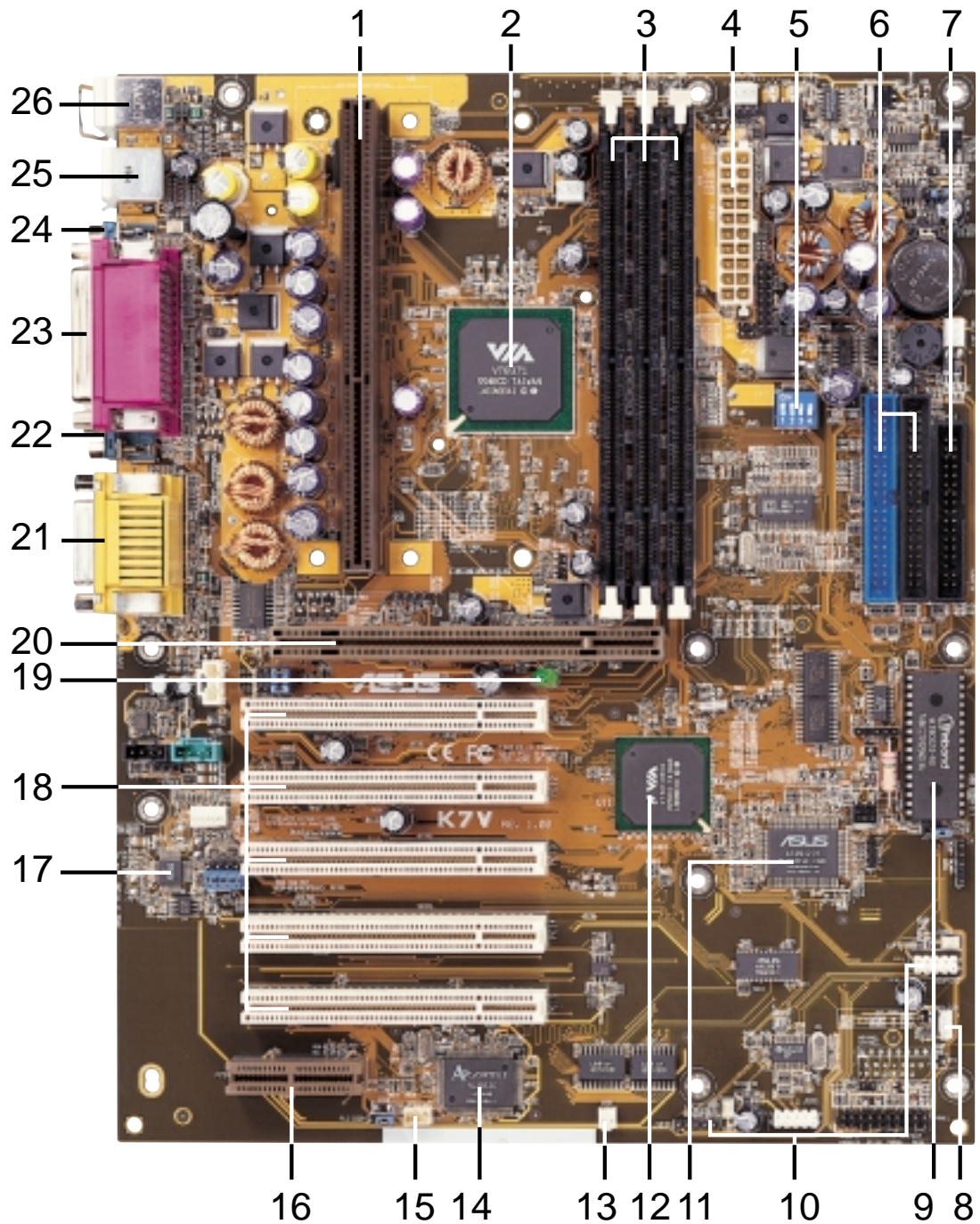

3. HARDWARE SETUP

3.1 K7V Motherboard Layout

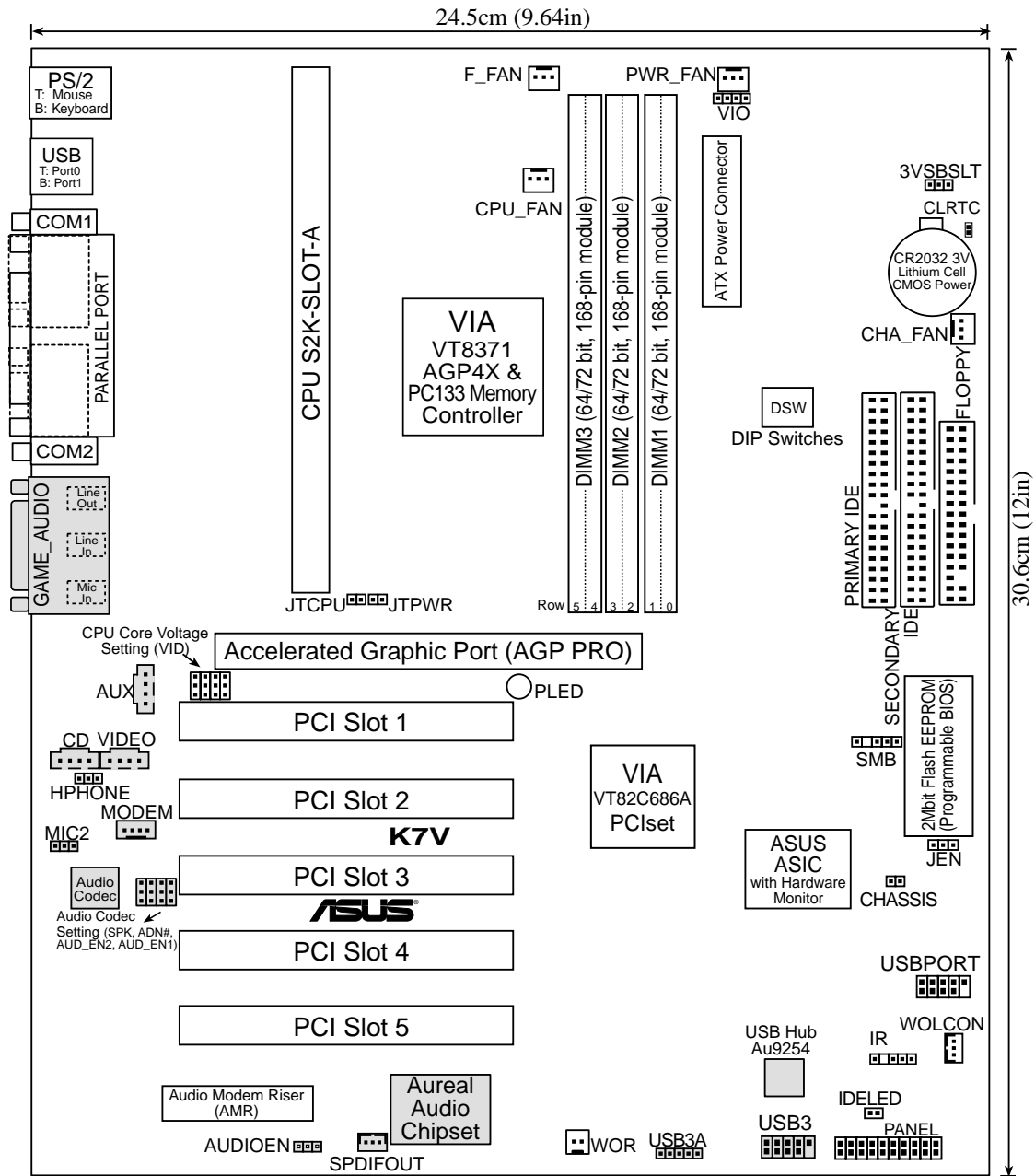

Grayed items are optional at the time of purchase.

3. HW/SETUP
Motherboard Layout

3. HARDWARE SETUP

3.2 Layout Contents

Motherboard Settings

- | | |
|---------------------|---|
| 1) JEN | p.18 JumperFree™ Mode (JEN) |
| 2) 3VSBSLT | p.18 Vaux Setting (+3V/+3VSB) |
| 3) AUDIO_CODEC | p.19 Onboard Audio Setting (Enable.../Disable...) |
| 4) VIO | p.19 I/O Voltage Setting (VIO) |
| 5) DSW | p.20 CPU External Frequency Setting |
| 6) VID1, VID2, VID3 | p.21 Voltage Regulator Output Setting |

Expansion Slots

- | | |
|---------------------------------|-------------------------------------|
| 1) DIMM1, DIMM2, DIMM3 | p.23 168-Pin DIMM Memory Support |
| 2) Slot A | p.25 Central Processing Unit (CPU) |
| 3) PCI1, PCI2, PCI3, PCI4, PCI5 | p.31 32-bit PCI Bus Expansion Slots |
| 4) AGP | p.33 Accelerated Graphics Port |
| 5) AMR | p.33 Audio Modem Riser Slot |

Connectors

- | | |
|-----------------------------|---|
| 1) PS2KBMS | p.35 PS/2 Mouse Connector (6-pin female) |
| 2) PS2KBMS | p.35 PS/2 Keyboard Connector (6-pin female) |
| 3) USB | p.36 Universal Serial Bus Ports 0 & 1 (Two 4-pin female) |
| 4) PRINTER | p.36 Parallel Port Connector (25-pin female) |
| 5) COM1, COM2 | p.36 Serial Port Connectors (Two 9-pin male) |
| 6) GAME_AUDIO | p.37 Joystick/MIDI Connector (15-pin female) (optional) |
| 7) GAME_AUDIO | p.37 Audio Port Connectors (Three 1/8" female) (optional) |
| 8) PRIMARY/SECONDARYIDE | p.38 Primary/Secondary IDE Connectors (Two 40-1pins) |
| 9) FLOPPY | p.38 Floppy Disk Drive Connector (34-1pins) |
| 10) WOL_CON | p.39 Wake-On-LAN Connector (3 pins) |
| 11) WOR | p.39 Wake-On-Ring Connector (2 pins) |
| 12) IDELED | p.40 IDE Activity LED (2 pins) |
| 13) PWR_, CPU_, CHA_, F_FAN | p.40 Power Supply, CPU, Chassis Fan Connectors (Three 3-pin) |
| 14) CD, AUX, VIDEO, MODEM | p.41 Internal Audio Connectors (Four 4 pins) (optional) |
| 15) HPHONE | p.41 Headphone True-Level Line Out Header (3 pins) (optional) |
| 16) IR | p.42 Serial Infrared Module Connector (5-1 pins) |
| 17) SMB | p.42 SMBus Connector (5-1 pins) |
| 18) CHASSIS | p.43 Chassis Intrusion Alarm Lead (4-1 pins) |
| 19) ATXPWR | p.43 ATX Power Supply Connector (20 pins) |
| 20) USBPORT | p.44 USB Connector Set (10-1 pins) |
| 21) SPDIFOUT | p.44 Digital Audio Interface Connector (3 pins) |

3. HARDWARE SETUP

22) SPEAKER (PANEL)	p.46 System Warning Speaker Connector (4 pins)
23) PWRLED (PANEL)	p.46 System Power LED Lead (3-1 pins)
24) MSGLED (PANEL)	p.46 System MessageLED Lead (2 pins)
25) RESET (PANEL)	p.46 Reset Switch Lead (2 pins)
26) PWRSW (PANEL)	p.46 ATX Power / Soft-Off Switch Lead (2 pins)
27) SMI (PANEL)	p.46 System Management Interrupt Switch Lead (2 pins)

3. HARDWARE SETUP

3.3 Hardware Setup Procedure

Before using your computer, you must complete the following steps:

- Check Motherboard Settings
- Install Memory Modules
- Install the Central Processing Unit (CPU)
- Install Expansion Cards
- Connect Ribbon Cables, Panel Wires, and Power Supply

3.4 Motherboard Settings

This section explains in detail how to change your motherboard's function settings through the use of switches and/or jumpers.

WARNING! Computer motherboards and expansion cards contain very delicate Integrated Circuit (IC) chips. To protect them against damage from static electricity, you should follow some precautions whenever you work on your computer.

1. Unplug your computer when working on the inside.
2. Use a grounded wrist strap before handling computer components. If you do not have one, touch both of your hands to a safely grounded object or to a metal object, such as the power supply case.
3. Hold components by the edges and try not to touch the IC chips, leads or connectors, or other components.
4. Place components on a grounded antistatic pad or on the bag that came with the component whenever the components are separated from the system.
5. Ensure that the ATX power supply is switched off before you plug in or remove the ATX power connector on the motherboard.

Motherboard Feature Settings (DSW)

Besides jumper settings, some of the motherboard's onboard functions are adjusted through the DIP switches. The white block represents the switch's position. The example below shows all the switches in the OFF position.

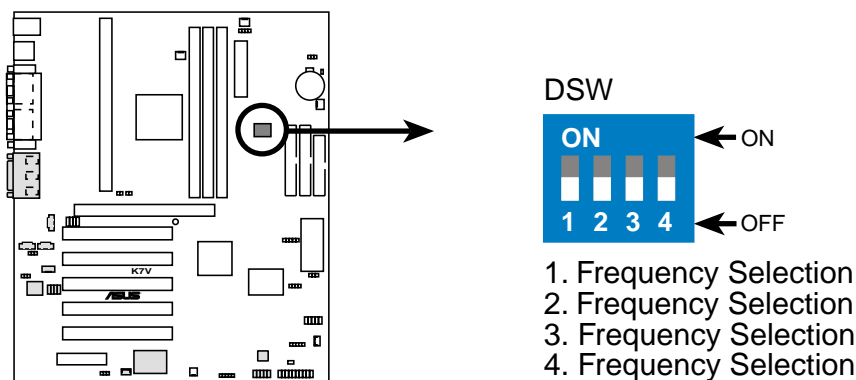

K7V DIP Switches

3. HARDWARE SETUP

1) JumperFree™ Mode (JEN)

This jumper allows you to enable or disable the JumperFree™ mode. The JumperFree™ mode allows processor settings to be made through the BIOS setup (see *4.4 Advanced Menu*).

IMPORTANT: In JumperFree™ mode, all DIP switches (DSW) must be set to OFF and VID1, VID2, and VID3 (see *6 Voltage Regulator Output Setting*) must be set to [3-4].

Setting	JEN
Enable (JumperFree)	[2-3] (default)
Disable (Jumper)	[1-2]

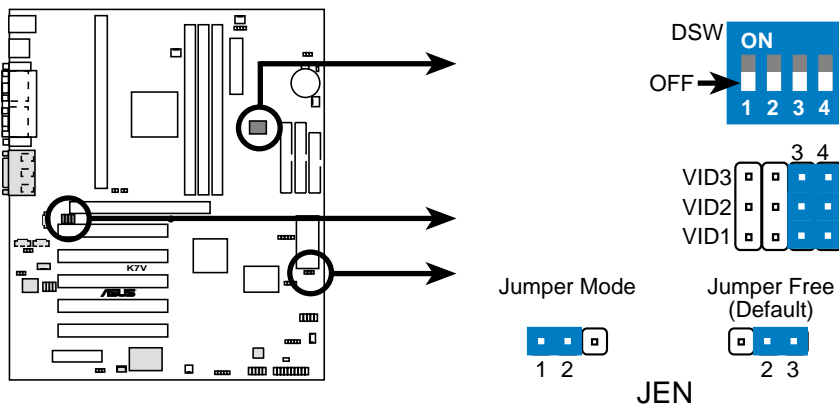

K7V Jumper Mode Setting

2) PCI 3Volt Setting (3VSBSLT)

This jumper allows you to select the voltage supplied to PCI devices. If you have PCI devices that require auxiliary power, set this jumper to 3 VSB.

Setting	3VSBSLT
3 Volt	[1-2]
3 VSB	[2-3] (default)

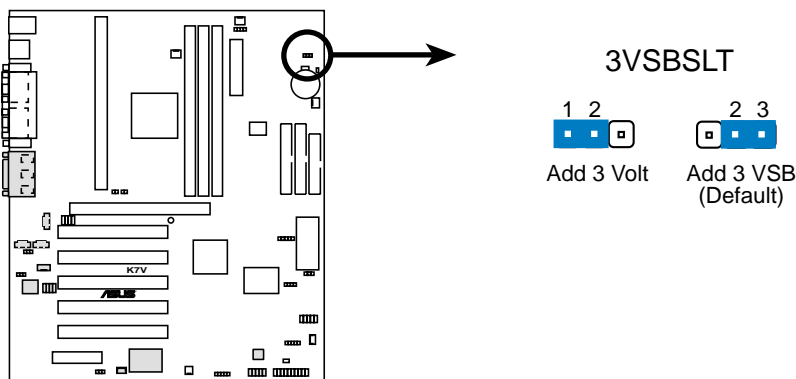

K7V PCI 3Volt Selection

3. HARDWARE SETUP

3) Onboard Audio Setting (available on audio model only)

The onboard audio CODEC may be enabled or disabled using all of these jumpers. Disable the onboard audio CODEC if you are using a PCI audio card on any of the expansion slots or a primary AMR on the AMR slot (see AMR Slot later in this section). If using a PCI audio expansion card, **Onboard AC'97 Audio Controller** in *4.4.5 Peripheral Setup* must also be disabled.

Setting	AUDIO CODEC			
Enable	[1-2]	[1-2]	[1-2]	[1-2] (default)
Disable	[2-3]	[2-3]	[2-3]	[2-3]

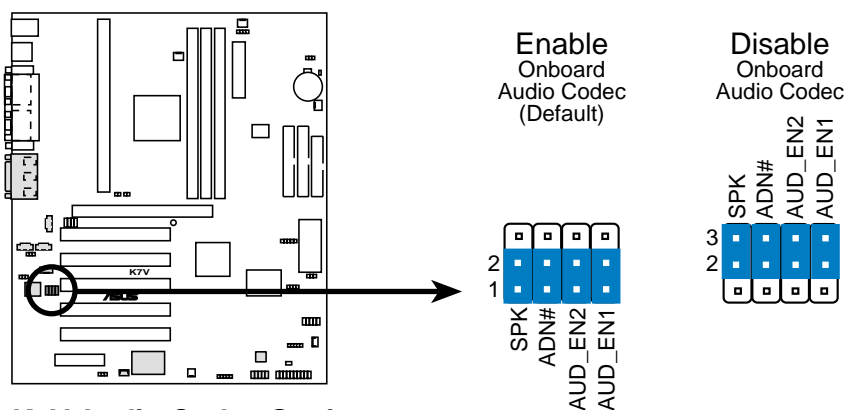

K7V Audio Codec Setting

4) I/O Voltage Setting (VIO)

VIO allows you to select the voltage supplied to the DRAM, chipset, AGP, PCI, and the CPU's I/O buffer. The default voltage (3.31V) should be used unless processor overclocking requires a higher voltage.

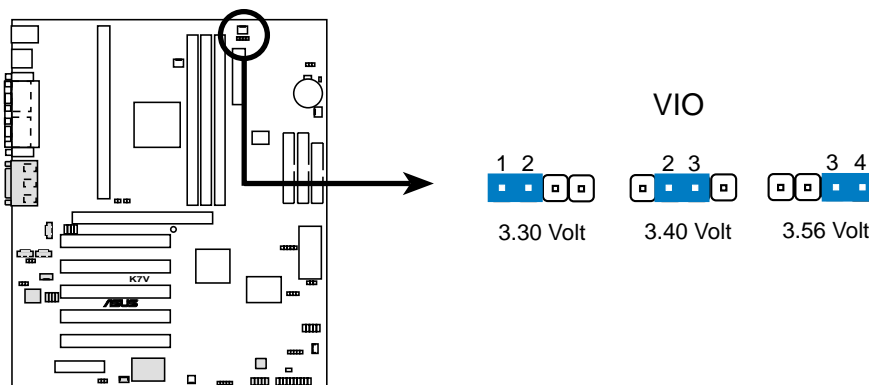

K7V VIO Setting

WARNING! Using a higher voltage may help when overclocking but may result in the shortening of your computer component's life. It is strongly recommended that you leave this setting on its default.

3. HARDWARE SETUP

5) CPU External Frequency Setting (DSW)

This option tells the clock generator what frequency to send to the CPU, SDRAM, and the chipset. This allows the selection of the CPU's *External* frequency. The CPU External Frequency multiplied by the Frequency Multiple equals the CPU's *Internal* frequency (the advertised CPU speed).

IMPORTANT:

1. To use this feature, JEN [see 1) *JumperFree™ Mode (JEN)* in 3. *HARDWARE SETUP*] must be set to Jumper mode or *Disable* [1-2].
2. In JumperFree mode, all dip switches (DSW-1–DSW-4) must be set to OFF.
3. When JumperFree mode is enabled, use BIOS setup in place of these switches (set *Operating Frequency Setting* to *User Define* under 4.4 *Advanced Menu* in BIOS Setup so you can set the *CPU Frequency*).

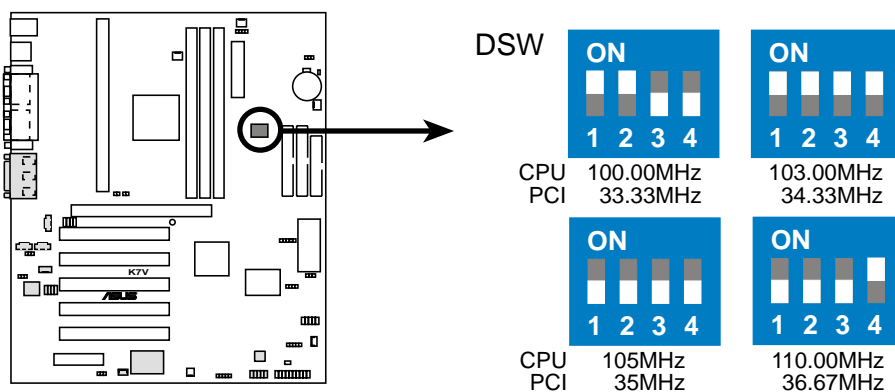

K7V CPU External Frequency Selection

NOTE: Frequency Multiple settings are not available here because AMD Athlon™ processors have locked Frequency Multiples.

NOTE: The motherboard supports PC100 / PC133 DIMMs or VC SDRAMs for system memory. Registered DIMMs are not supported (see 3.5 **System Memory (DIMM)**).

3. HARDWARE SETUP

External Frequency Table

CPU (MHz)	PCI (MHz)	Frequency Selection Switches			
		1	2	3	4
100.00	33.33	[ON]	[ON]	[OFF]	[OFF]
103.00	34.33	[ON]	[ON]	[ON]	[ON]
105.00	35	[OFF]	[OFF]	[OFF]	[OFF]
110.00	36.67	[OFF]	[OFF]	[OFF]	[ON]

NOTE: For updated processor settings, visit the ASUS web site (see **ASUS CONTACT INFORMATION**).

WARNING! Premature wearing of the processor may result when overclocking. Be sure that the DIMM you use can handle the specified SDRAM MHz or else bootup will not be possible.

6) Voltage Regulator Output Setting (VID1, VID2, VID3)

This jumpers allow you to manually adjust the CPU core voltage. It is recommended to use **CPU Default** as the CPU core voltage. **CPU Default** means the Vcore is generated according to the CPU VID configuration. For each jumper setting, there are two voltage options, depending on the CPU used.

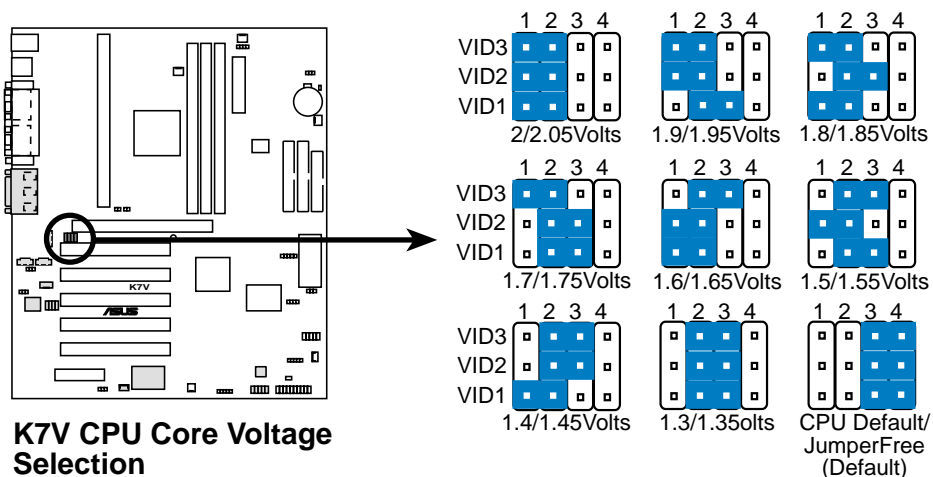

3. HARDWARE SETUP

3.5 System Memory (DIMM)

NOTE: No hardware or BIOS setup is required after adding or removing memory. This motherboard uses only Dual Inline Memory Modules (DIMMs). Sockets are available for **3.3Volt** (power level) unbuffered Synchronous Dynamic Random Access Memory (SDRAM) of 16, 32, 64, 128MB, 256 or 512MB. to form a memory size between 16MB and 1.5GB. One side (with memory chips) of the DIMM takes up one row on the motherboard. This motherboard also supports NEC's Virtual Channel (VC) SDRAMs.

To use the chipset's Error Checking and Correction (ECC) feature, you must use a DIMM with 9 chips per side (standard 8 chips/side + 1 ECC chip).

Memory speed setup is recommended through **Configure SDRAM Timing by SPD** (see *4.4.2 Advanced Chipset Setup*).

Install memory in any combination as follows:

IMPORTANT

- For optimum signal integrity, inserting the DIMMs in the following order is recommended: DIMM1, DIMM2, DIMM3.
- SDRAMs used must be compatible with the current PC133/PC100 SDRAM specification.
- DO NOT attempt to mix SDRAMs with VCM SDRAMs.

Location	168-pin DIMM	Total Memory
DIMM1 (Rows 0&1)	SDRAM 16, 32, 64, 128, 256, 512MB	x1
DIMM2 (Rows 2&3)	SDRAM 16, 32, 64, 128, 256, 512MB	x1
DIMM3 (Rows 4&5)	SDRAM 16, 32, 64, 128, 256, 512MB	x1
Total System Memory (Max 768B)		=

3.5.1 General DIMM Notes

- This motherboard supports SPD (Serial Presence Detect) DIMMs. This is the memory of choice for best performance vs. stability.
- This motherboard does NOT support registered memory.
- SDRAM chips are generally thinner with higher pin density than EDO (Extended Data Output) chips.
- BIOS shows SDRAM memory on bootup screen.
- Single-sided DIMMs come in 16, 32, 64, 128, 256MB; double-sided come in 32, 64, 128, 256, 512MB.

3. HARDWARE SETUP

3.5.2 DIMM Memory Installation

Insert the module(s) as shown. Because the number of pins are different on either side of the breaks, the module will only fit in the orientation shown. DIMM modules are longer and have different pin contact on each side and therefore have a higher pin density. SIMM modules have the same pin contact on both sides.

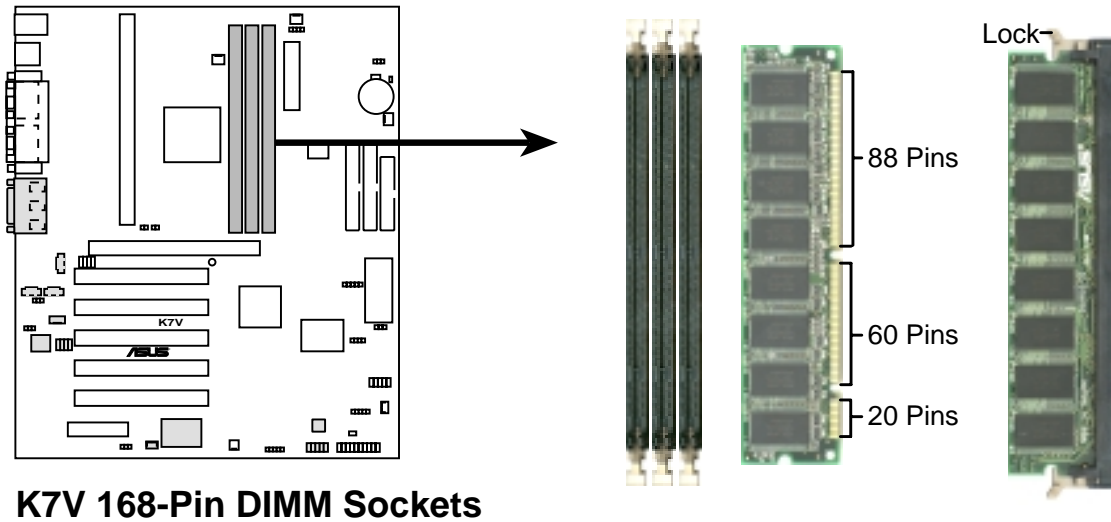

K7V 168-Pin DIMM Sockets

3. HW SETUP
System Memory

The DIMMs must be **3.3V Unbuffered** for this motherboard. To determine the DIMM type, check the notches on the DIMMs (see figure below).

168-Pin DIMM Notch Key Definitions (3.3V)

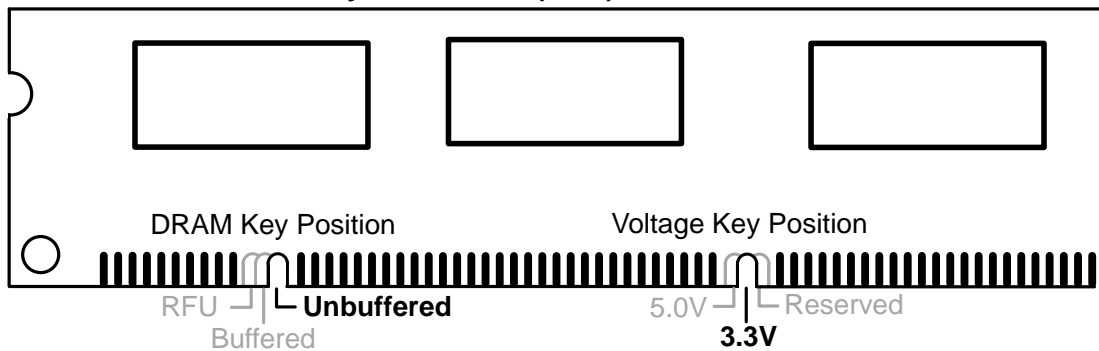

The notches on the DIMM module will shift between left, center, or right to identify the type and also to prevent the wrong type from being inserted into the DIMM slot on the motherboard. You must ask your retailer the correct DIMM type before purchasing. This motherboard supports four clock signals.

3. HARDWARE SETUP

(This page was intentionally left blank.)

3. HARDWARE SETUP

3.6 Central Processing Unit (CPU)

NOTE: The following pictures are provided for reference purposes only. The appearance of your retention mechanism and fan may be different from the following examples.

Your K7 Series motherboard provides a Slot A connector for an AMD Athlon™ processor.



AMD Athlon™ processor with heatsink and fan (top view)

3.6.1 Quick CPU Installation Procedure

1. Attach the heatsink to the processor with thermal grease and retention clip. The recommended heatsinks (see section on recommended heatsinks for your processor) are those with three-pin fans that can be connected to the fan connectors on the motherboard.

WARNING! Be sure that there is sufficient air circulation across the processor's heatsink by regularly checking that your CPU fan is working. Without sufficient circulation, the processor could overheat and damage both the processor and the motherboard. You may install an auxiliary chassis fan, if necessary.

2. Install the Universal Retention Mechanism onto the motherboard.
3. Insert the processor.

3. HARDWARE SETUP

3.6.2 Attaching the Heatsink

NOTE: If provided, you should follow the heatsink attachment instructions that came with your heatsink or processor. The following steps are provided only as a general guide and may not reflect those for your heatsink.

1. Attach the heatsink to the processor core with a good quality thermal interface material.
2. Mount the heatsink to the processor package.

Push the two lock arms one direction to clamp the heatsink onto the processor and the other direction to release.



WARNING! Make sure the heatsink is mounted tightly against the SECC; otherwise, the CPU will overheat. You may install an auxiliary fan to provide adequate circulation across the processor's passive heatsink.

3.6.3 Installing the Universal Retention Mechanism

Your motherboard comes with a set of Universal Retention Mechanism (URM), which supports Athlon processors. There are two types of URMs: (A) With Integrated Retainer Pins and (B) With Separate Retainer Pins.

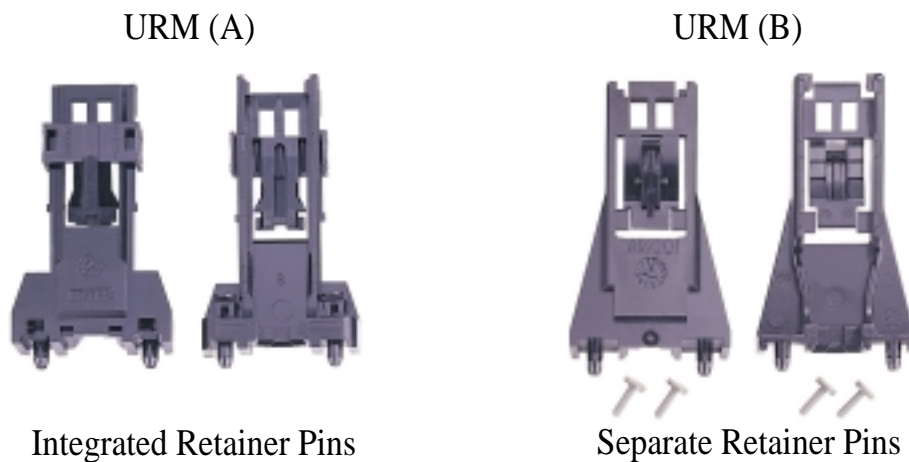

3. HARDWARE SETUP

1. Place the motherboard on the anti-static foam that was shipped with the motherboard. Do not place the motherboard on a hard surface while installing the URM as the black fastener sleeves must protrude through the bottom of the motherboard.
2. Locate the Slot A connector on the motherboard.
3. Position the retention mechanism on either side of the Slot A connector.
4. Making sure that the top retainer pins are not pushed in, press down on the retention brackets until the black fastener sleeves fit snugly against the board.

WARNING! Installing the URM while the retainer pins are pushed in will not only cause the URM to be installed improperly but will also damage the URM.

5. Push the four retainer pins completely down into the black fastener sleeves until the head of each pin is securely seated.

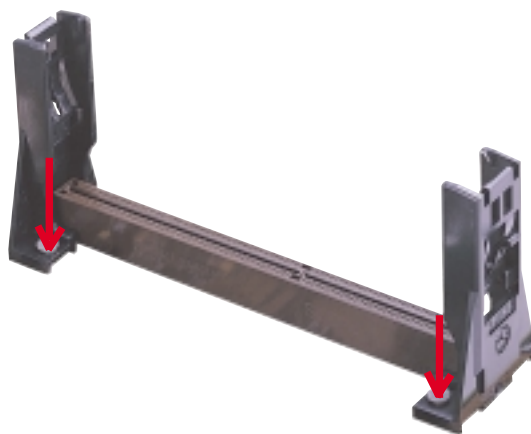

3.6.4 Installing the Processor

NOTE: The following steps assume that you have already attached the heatsink and installed the URM into your motherboard.

1. Make sure that the processor substrate key is aligned with the Slot A connector key.

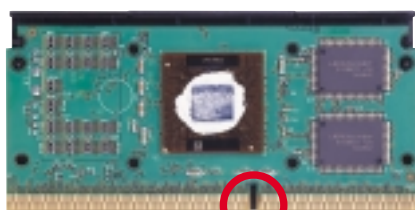

Substrate Key

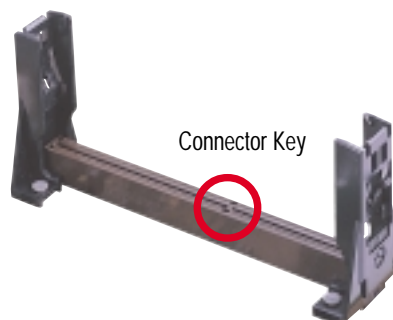

Connector Key

3. HARDWARE SETUP

2. Push down firmly but gently the processor into the URM until it snaps into place.

NOTE: The processor edge fingers must be kept parallel to the connector or else misalignment will occur.

Secure the assembly in place by pushing the two locks outward so that the locks show through the retention mechanism's lock holes.

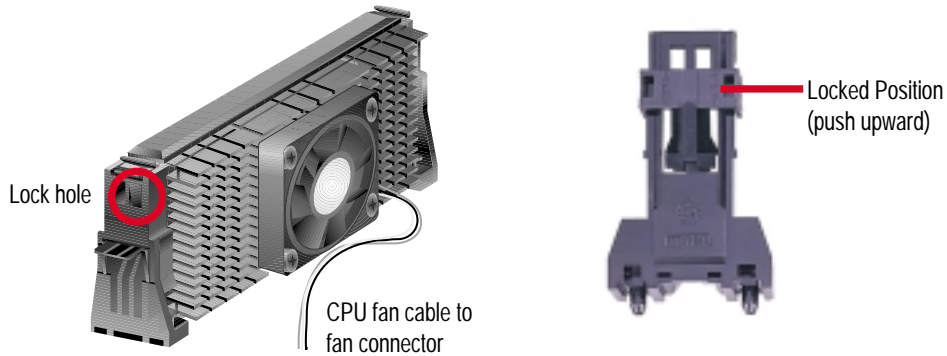

3.6.5 Removing the Processor

Push the two locks inward to disengage the latch feature and firmly lift the assembly out of the URM.

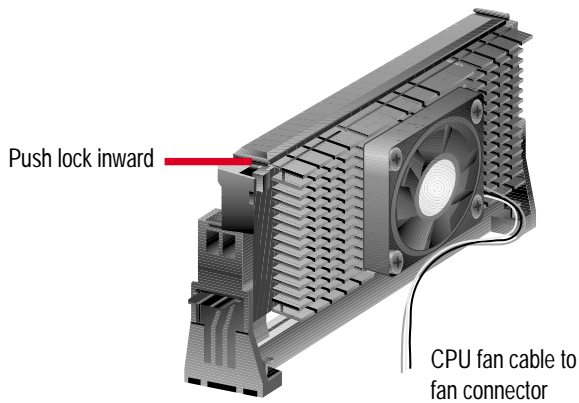

CAUTION! You may wear gloves to protect your hands from the sharp edges when removing processors.

3. HARDWARE SETUP

3.6.6 Smart Thermal Solutions

Two smart solutions to Slot A CPU thermal problems are available from ASUSTeK COMPUTER INC.: the **ASUS Smart Fan** or **ASUS S-K7FAN** and the **ASUS P2T-Cable**.

ASUS S-K7FAN

The optional ASUS Smart Fan or ASUS S-K7FAN is a CPU fan for a processor packaged in a Single Edge Contact Cartridge (SECC). Unlike other CPU thermal solutions, the ASUS S-K7FAN has an integrated thermal sensor located near the center of the CPU heat source. The sensor is optimized to give the most accurate reading of the CPU temperature, thus provides the best protection to your computer system.

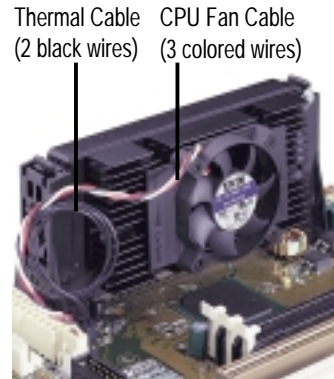

To Use the ASUS S-K7FAN

See **2. Attach the Heatsink** on the preceding page for the relevant procedures. Note that the S-K7FAN comes with a rock arm design for easy FAN/CPU installation.

ASUS P2T-Cable

The optional ASUS P2T-Cable can be used for a processor packaged in an SECC2/SECC/SEPP.

NOTE: The ASUS P2T-Cable can only be used in a Slot A motherboard with a 2-pin thermal sensor connector.

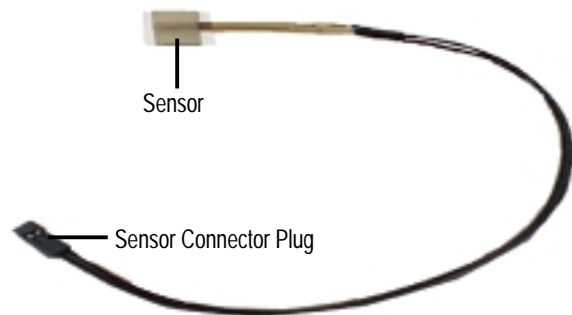

To Use the ASUS P2T-Cable

NOTE: The following procedures assume that you have properly attached a heatsink onto an SECC2/SECC/SEPP.

1. Simply peel off the tab from the sensor and then stick the sensor near the middle edge of the boxed processor heatsink with fan, as indicated.



3. HARDWARE SETUP

WARNING! Do not insert the sensor between the processor and heatsink, otherwise, it will cause damage to the P2T-Cable.

IMPORTANT! Accurate readings are guaranteed only for the ASUS Smart Fan.

2. Connect the P2T-Cable to the CPU thermal sensor connector (JT CPU).

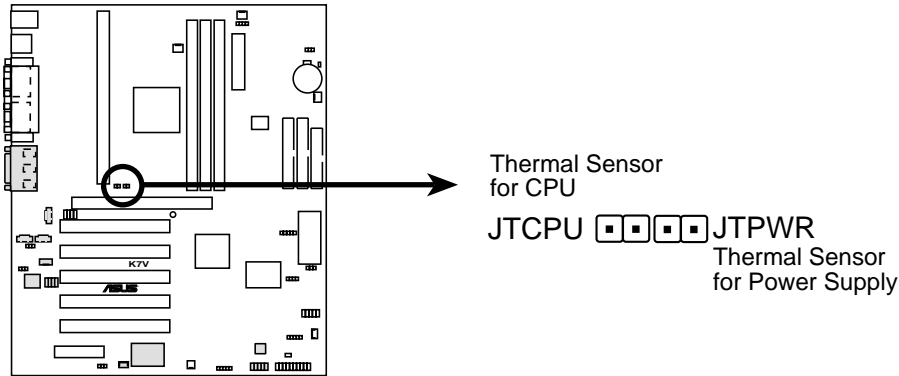

K7V Thermal Sensor Connectors

NOTE: If you have a power supply with thermal monitoring, connect its thermal sensor cable to JTPWR.

3.6.7 Recommended Heatsinks for Slot A Processors

The recommended heatsinks for the Slot A processors are those with three-pin fans, such as the ASUS Smart Fan, that can be connected to the motherboard's CPU fan connector. These heatsinks dissipate heat more efficiently and with an optional hardware monitor, they can monitor the fan's RPM and use the alert function with the Intel LANdesk Client Manager (LDCM) or the ASUS PC Probe software.



SECC Heatsink & Fan

3. HARDWARE SETUP

3.7 Expansion Cards

WARNING! Unplug your power supply when adding or removing expansion cards or other system components. Failure to do so may cause severe damage to both your motherboard and expansion cards.

3.7.1 Expansion Card Installation Procedure

1. Read the documentation for your expansion card and make any necessary hardware or software settings for your expansion card, such as jumpers.
2. Remove your computer system's cover and the bracket plate on the slot you intend to use. Keep the bracket for possible future use.
3. Carefully align the card's connectors and press firmly.
4. Secure the card on the slot with the screw you removed above.
5. Replace the computer system's cover.
6. Set up the BIOS if necessary
(such as *IRQ xx Used By ISA: Yes* in PNP AND PCI SETUP)
7. Install the necessary software drivers for your expansion card.

3.7.2 Assigning IRQs for Expansion Cards

Some expansion cards need an IRQ to operate. Generally, an IRQ must be exclusively assigned to one use. In a standard design, there are 16 IRQs available but most of them are already in use, leaving 6 IRQs free for expansion cards. If your motherboard has **PCI** audio onboard, an additional IRQ will be used. If your motherboard also has **MIDI** enabled, another IRQ will be used, leaving 4 IRQs free.

3. HARDWARE SETUP

The following table lists the default IRQ assignments for standard PC devices. Use this table when configuring your system and for resolving IRQ conflicts.

Standard Interrupt Assignments

IRQ	Priority	Standard Function
0	1	System Timer
1	2	Keyboard Controller
2	N/A	Programmable Interrupt
3*	11	Communications Port (COM2)
4*	12	Communications Port (COM1)
5*	13	
6	14	Floppy Disk Controller
7*	15	Printer Port (LPT1)
8	3	System CMOS/Real Time Clock
9*	4	ACPI Mode when enabled
10*	5	IRQ Holder for PCI Steering
11*	6	IRQ Holder for PCI Steering
12*	7	PS/2 Compatible Mouse Port
13	8	Numeric Data Processor
14*	9	Primary IDE Channel
15*	10	Secondary IDE Channel

*These IRQs are usually available for ISA or PCI devices.

Interrupt Request Table for this Motherboard

Interrupt requests are shared as shown by the following table:

	INT-A	INT-B	INT-C	INT-D
PCI slot 1	shared	—	—	—
PCI slot 2	—	not shared	—	—
PCI slot 3	—	—	shared	—
PCI slot 4	—	—	—	shared
PCI slot 5	—	—	—	shared
AGP slot	shared	—	—	—
Onboard USB controller	—	—	—	shared
Onboard AC'97/MC'97 codec/AMR	—	—	shared	—

IMPORTANT: If using PCI cards on shared slots, make sure that the drivers support “Share IRQ” or that the cards do not need IRQ assignments. Conflicts will arise between the two PCI groups that will make the system unstable or cards inoperable.

3. HARDWARE SETUP

3.7.3 Accelerated Graphics Port Pro (AGP Pro)

This motherboard provides an Accelerated Graphics Port Pro (AGP Pro) slot to support AGP/AGP Pro graphics cards, such as an ASUS AGP-V6800DDR/64M.

CAUTION! To avoid damaging your AGP/AGP Pro graphics card, your computer's power supply should be unplugged before inserting your graphics card into the slot.

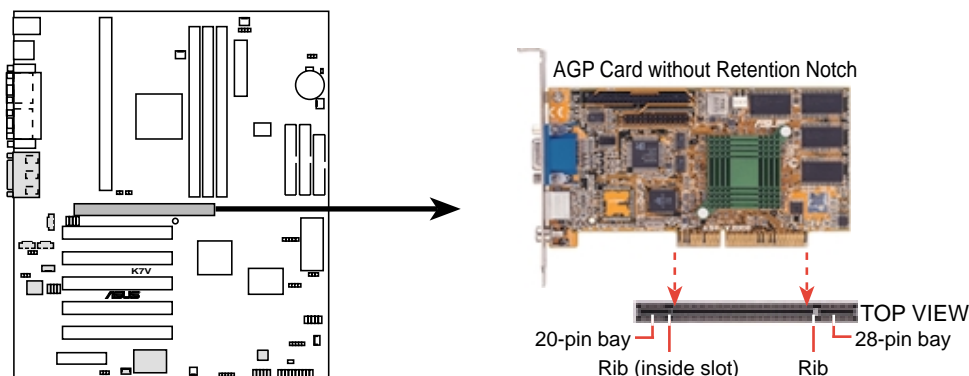

K7V Accelerated Graphics Port (AGP PRO)

CAUTION! The AGP Pro slot is shipped with a safety tab on the 20-pin bay for use with AGP cards *without* a retention notch. DO NOT remove this tab if you will be using such cards; removing may cause these cards to shift, which may cause damage to your card, slot, and motherboard. Remove **ONLY** when you will be using an *AGP Pro* card. Use a rigid tip, such as a pen tip, to dislodge and remove the tab from the bay.

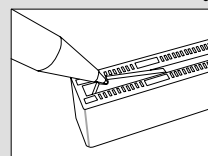

Removing the tab

3. HW SETUP
Expansion Cards

3.7.4 Audio Modem Riser (AMR) Slot

This connector supports a specially designed audio and/or modem card called an AMR. Main processing is done through software and controlled by the motherboard's system chipset. This provides an upgradeable audio and/or modem solution at an incredibly low cost. There are two types of AMR, one defined as primary and another defined as secondary. This motherboard uses the primary channel so that a secondary AMR can coexist without the need to disable the onboard CODEC. The motherboard's onboard CODEC (optional) must be disabled when using a primary AMR.

NOTE: An AMR is not included with this motherboard.

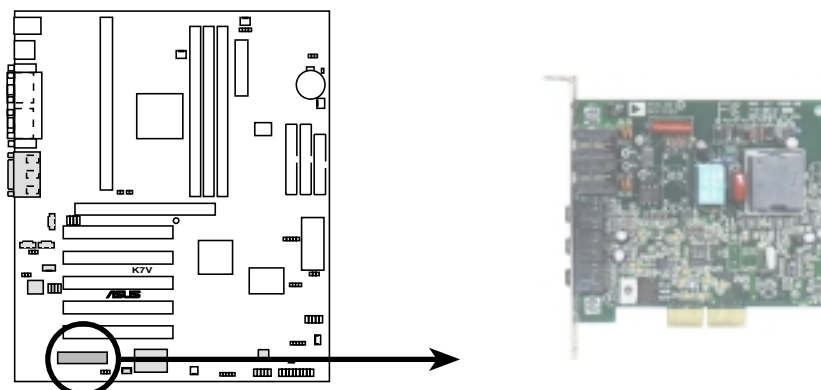

K7V Audio Modem Riser (AMR) Slot

3. HARDWARE SETUP

(This page was intentionally left blank.)

3. HARDWARE SETUP

3.8 External Connectors

WARNING! Some pins are used for connectors or power sources. These are clearly distinguished from jumpers in the Motherboard Layout. Placing jumper caps over these connector pins will cause damage to your motherboard.

IMPORTANT: Ribbon cables should always be connected with the red stripe to Pin 1 on the connectors. Pin 1 is usually on the side closest to the power connector on hard drives and CD-ROM drives, but may be on the opposite side on floppy disk drives. Check the connectors before installation because there may be exceptions. IDE ribbon cable must be less than 46 cm (18 in.), with the second drive connector no more than 15 cm (6 in.) from the first connector.

1) PS/2 Mouse Connector (Green 6-pin PS2KBMS)

The system will direct IRQ12 to the PS/2 mouse if one is detected. If one is not detected, expansion cards can use IRQ12. See **PS/2 Mouse Function Control** in *4.4 Advanced Menu*.

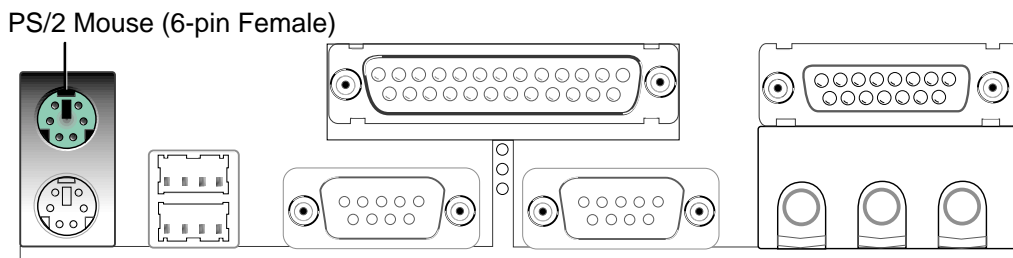

2) PS/2 Keyboard Connector (Purple 6-pin PS2KBMS)

This connection is for a standard keyboard using an PS/2 plug (mini DIN). **This connector will not allow standard AT size (large DIN) keyboard plugs.** You may use a **DIN to mini DIN adapter** on standard AT keyboards.

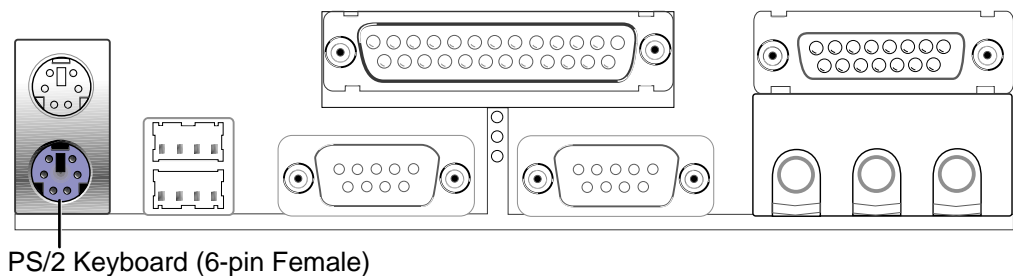

3. HARDWARE SETUP

3) Universal Serial BUS Ports 0 & 1 (Black two 4-pin USB)

Two USB ports are available for connecting USB devices.

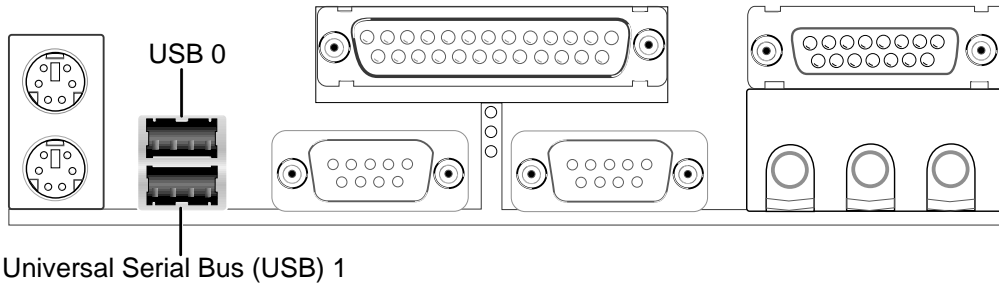

4) Parallel Port Connector (Burgundy 25-pin PRINTER)

You can enable the parallel port and choose the IRQ through **Onboard Parallel Port** (see **4.4.2 I/O Device Configuration**).

NOTE: Serial printers must be connected to the serial port.

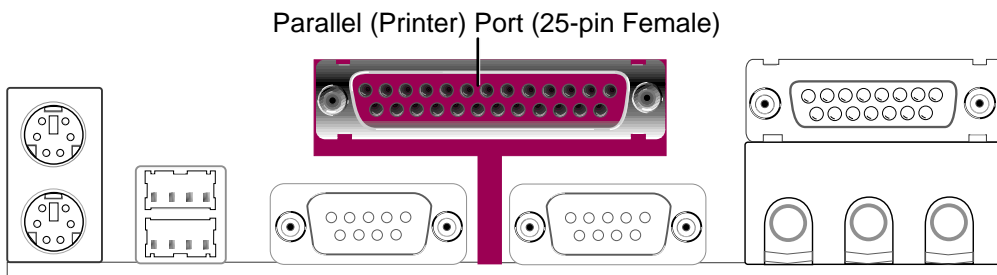

5) Serial Port Connectors (Teal/Turquoise 9-pin COM1/COM2)

One serial port is ready for a mouse or other serial devices. A second serial port is available using a serial port bracket connected from the motherboard to an expansion slot opening. See **Onboard Serial Port 1** in **4.2.2 I/O Device Configuration** for settings.

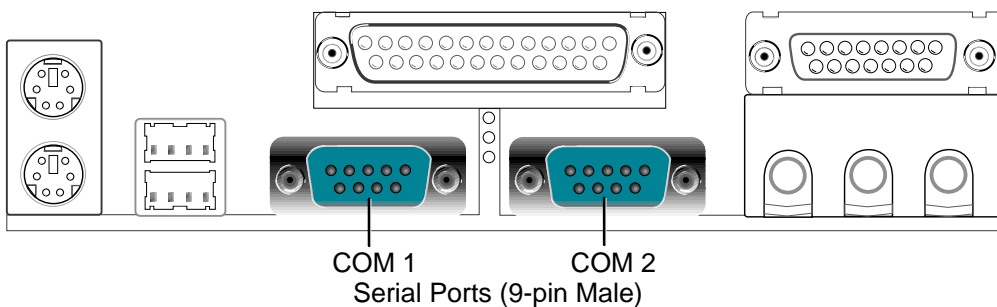

3. HARDWARE SETUP

6) Joystick/MIDI Connector (Gold 15-pin GAME_AUDIO) (optional)

You may connect game joysticks or game pads to this connector for playing games. Connect MIDI devices for playing or editing professional audio.

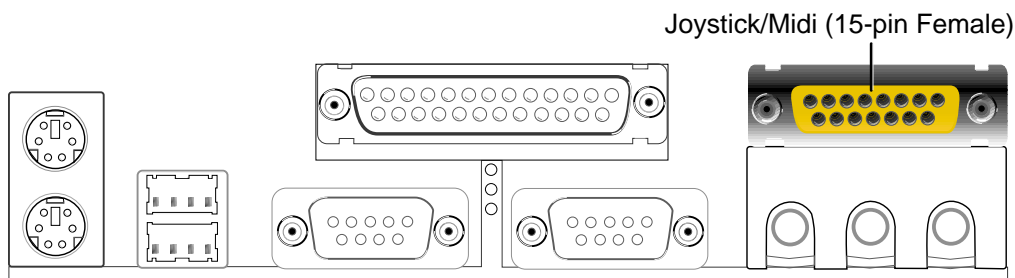

7) Audio Port Connectors (Three 1/8" GAME_AUDIO) (optional)

Line Out (lime) can be connected to headphones or preferably powered speakers. **Line In** (light blue) allows tape players or other audio sources to be recorded by your computer or played through the **Line Out** (lime). **Mic** (pink) allows microphones to be connected for inputting voice.

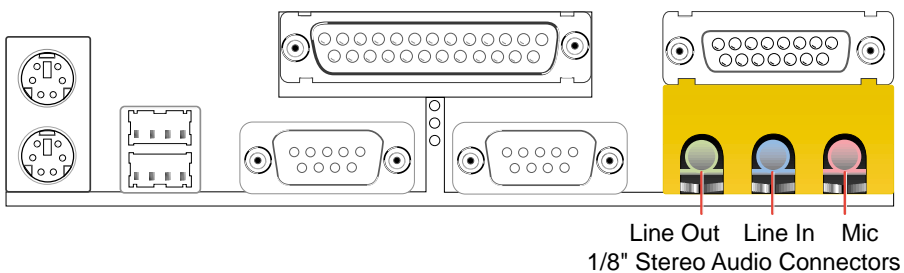

3. HARDWARE SETUP

8) Primary (Blue) / Secondary IDE Connectors (Two 40-1pin IDE)

These connectors support the provided UltraDMA/66 IDE hard disk ribbon cable. Connect the cable's blue connector to the motherboard's primary (recommended) or secondary IDE connector, and then connect the gray connector to your UltraDMA/66 slave device (hard disk drive) and the black connector to your UltraDMA/66 master device. It is recommended that non-UltraDMA/66 devices be connected to the secondary IDE connector. If you install two hard disks, you must configure the second drive to Slave mode by setting its jumper accordingly. Please refer to your hard disk documentation for the jumper settings. BIOS now supports specific device bootup (see *4.4.1 Advanced CMOS Setup*). **(Pin 20 is removed to prevent inserting in the wrong orientation when using ribbon cables with pin 20 plugged).**

TIP: You may configure two hard disks to be both Masters with two ribbon cables – one for the primary IDE connector and another for the secondary IDE connector. You may install one operating system on an IDE drive and another on a SCSI drive and select the boot disk through *4.4.1 Advanced CMOS Setup*.

IMPORTANT: UltraDMA/66 IDE devices must use a 40-pin 80-conductor IDE cable for 66MBytes/s transfer rates.

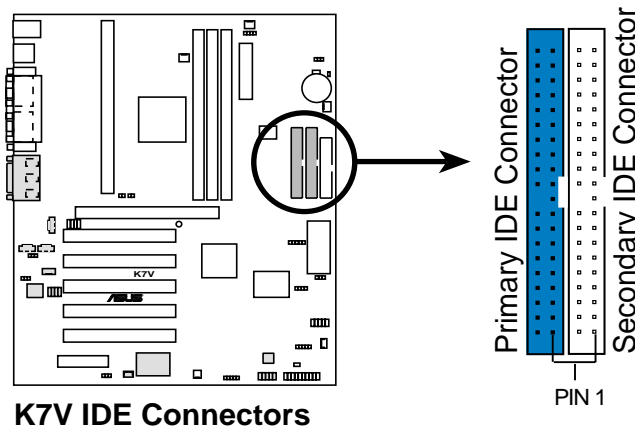

NOTE: Orient the red markings (usually zigzag) on the IDE ribbon cable to PIN 1.

9) Floppy Disk Drive Connector (34-1pin FLOPPY)

This connector supports the provided floppy drive ribbon cable. After connecting the single end to the board, connect the two plugs on the other end to the floppy drives. **(Pin 5 is removed to prevent inserting in the wrong orientation when using ribbon cables with pin 5 plugged).**

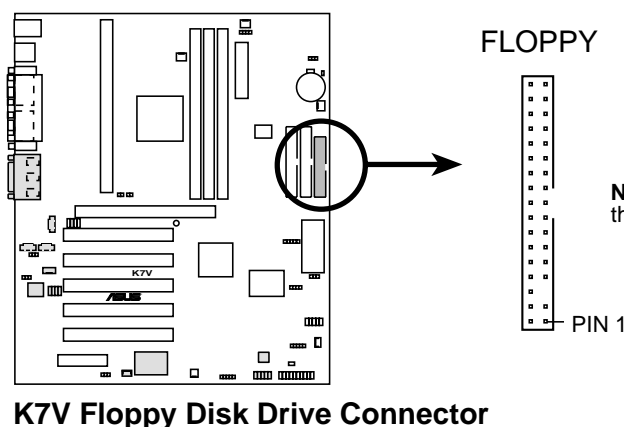

NOTE: Orient the red markings on the floppy ribbon cable to PIN 1.

3. HARDWARE SETUP

10) Wake-On-LAN Connector (3-pin WOL_CON)

This connector connects to a LAN card with a Wake-On-LAN output, such as the ASUS PCI-L101 Ethernet card (see 7. *Appendix*). The connector powers up the system when a wakeup packet or signal is received through the LAN card.

IMPORTANT: This feature requires that **Wake-On-Lan** features are enabled (see 4.4.3 *Power Management*) and that your system has an ATX power supply with at least 720mA +5V standby power.

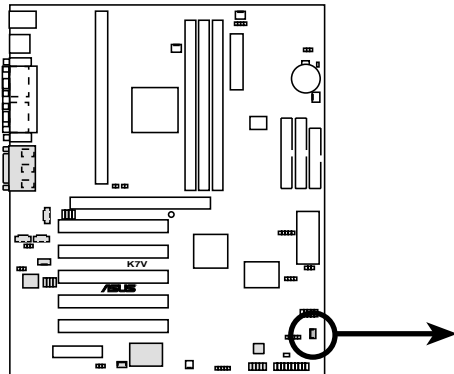

K7V Wake-On-LAN Connector

IMPORTANT: Requires an ATX power supply with at least 720mA +5 volt standby power

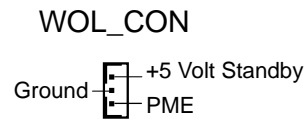

11) Wake-On-Ring Connector (2-pin WOR)

This connector connects to internal modem cards with a Wake-On-Ring output. The connector powers up the system when a ringup packet or signal is received through the internal modem card. **NOTE:** For external modems, Wake-On-Ring is detected through the COM port.

IMPORTANT: This feature requires that **Wake-On-Ring** features are enabled (see 4.4.3 *Power Management*) and that your system has an ATX power supply with at least 720mA +5V standby power.

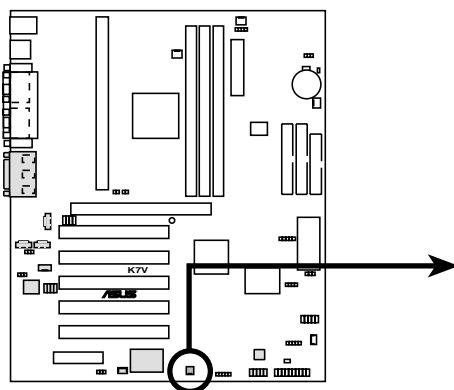

K7V Wake-On-Ring Connector

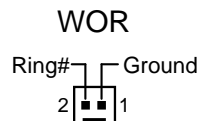

3. HARDWARE SETUP

12) IDE Activity LED (2-pin IDELED)

This connector supplies power to the cabinet's IDE activity LED. Read and write activity by devices connected to the Primary or Secondary IDE connectors will cause the LED to light up.

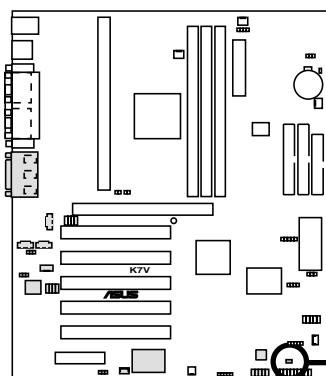

K7V IDE Activity LED

TIP: If the case-mounted LED does not light, try reversing the 2-pin plug.



13) Power Supply (PWR_FAN), CPU (CPU_FAN), Chassis (CHA_FAN / F_FAN) Fan Connectors (3 pins)

These connectors support cooling fans of 350mA (4.2 Watts) or less. Orientate the fans so that the heat sink fins allow airflow to go across the onboard heat sink(s) instead of the expansion slots. Depending on the fan manufacturer, the wiring and plug may be different. The red wire should be positive, while the black should be ground. Connect the fan's plug to the board taking into consideration the polarity of the connector.

NOTE: The "Rotation" signal is to be used only by a specially designed fan with rotation signal. The Rotations per Minute (RPM) can be monitored using ASUS PC Probe or Intel LDCM Utility. The Rotation signal is not supported by F_FAN.

WARNING! The CPU and/or motherboard will overheat if there is no airflow across the CPU and onboard heatsinks. Damage may occur to the motherboard and/or the CPU fan if these pins are incorrectly used. **These are not jumpers, do not place jumper caps over these pins.**

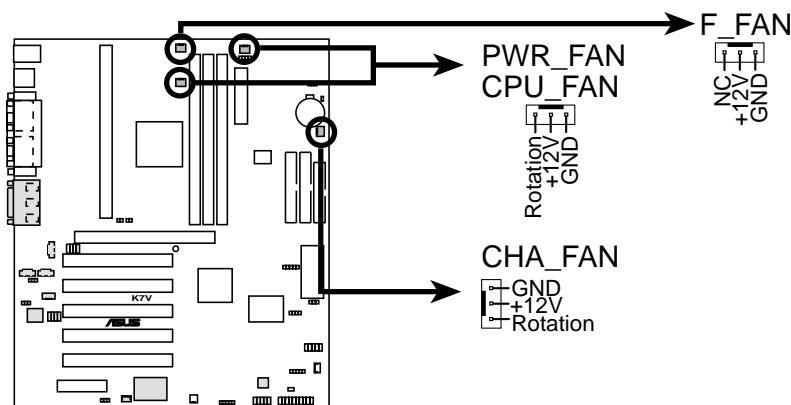

K7V 12-Volt Cooling Fan Power

3. HARDWARE SETUP

14) Internal Audio Connectors (4-pin CD, AUX, VIDEO, MODEM)

These connectors allow you to receive stereo audio input from such sound sources as a CD-ROM, TV tuner, or MPEG card. The MODEM connector allows the onboard audio to interface with a voice modem card with a similar connector. It also allows the sharing of mono_in (such as a phone) and mono_out (such as a speaker) between the onboard audio and a voice modem card.

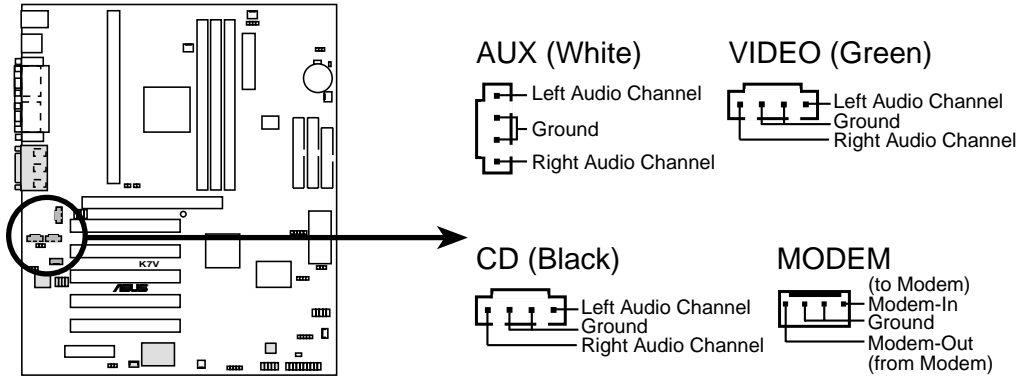

K7V Internal Audio Connectors

15) Headphone True-Level Line Out Header (3 pin HPHONE) (optional)

This connector allows you to connect a chassis mounted headphone to the motherboard instead of having to attach an external headphone onto the ATX connectors.

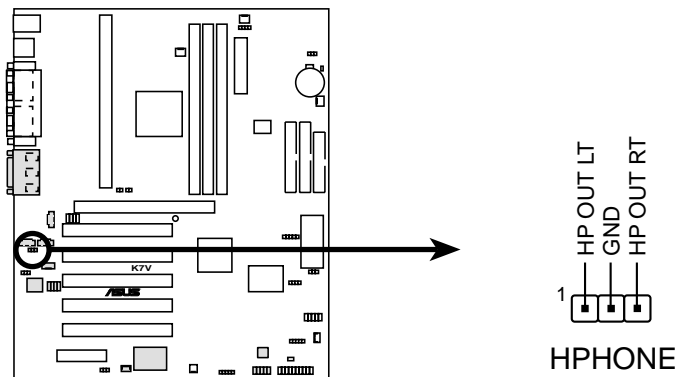

K7V True-Level Line Out Header

3. HARDWARE SETUP

16) Serial Infrared Module Connector (5-pin IR)

This connector supports an optional wireless transmitting and receiving infrared module. This module mounts to a small opening on system cases that support this feature. You must also configure the setting through **4.4.5 Peripheral Setup** to select whether UART2 is directed for use with COM2 or IrDA. Use the five pins as shown in Back View and connect a ribbon cable from the module to the motherboard's IR connector according to the pin definitions.

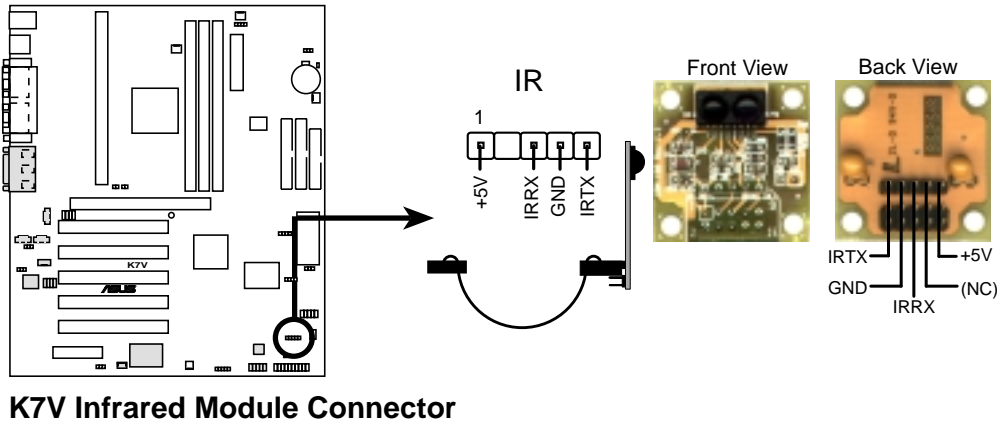

17) SMBus Connector (5-1 pin SMB)

This connector allows you to connect SMBus (System Management Bus) devices. SMBus devices communicate by means of the SMBus with an SMBus host and/or other SMBus devices. SMBus is a specific implementation of an I²C bus, which is a multi-device bus; that is, multiple chips can be connected to the same bus and each one can act as a master by initiating data transfer.

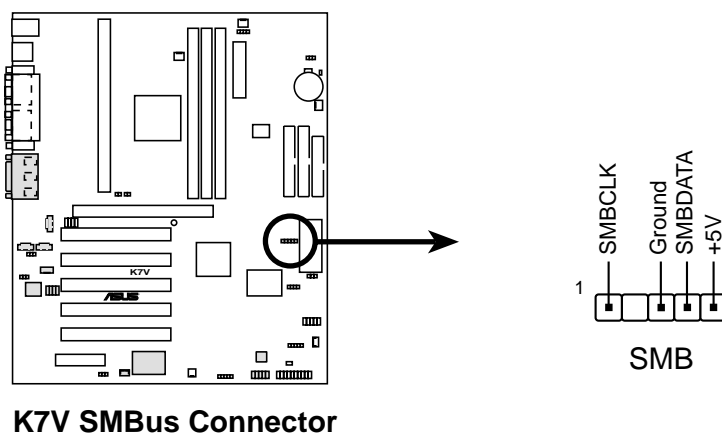

3. HARDWARE SETUP

18) Chassis Intrusion Lead (2-pin CHASSIS)

This lead is for a chassis designed for chassis intrusion detection. After-market toggle switches may also be installed to the chassis panel or on any removable components. Two wires should be available from the chassis to connect to this lead. When any chassis component is removed, the contact should open and the motherboard will record a chassis intrusion event. The event can then be processed by software, such as LDCM.

IMPORTANT: If the chassis intrusion lead is not used, a jumper cap must be placed over the pins to prevent unnecessary power loss.

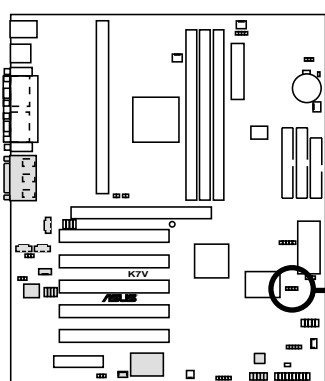

K7V Chassis Open Alarm Lead

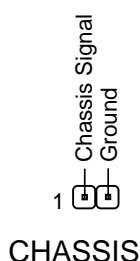

19) ATX Power Supply Connector (20-pin block ATXPWR)

This connector connects to an ATX power supply. The plug from the power supply will only insert in one orientation because of the different hole sizes. Find the proper orientation and push down firmly making sure that the pins are aligned.

IMPORTANT: Make sure that your ATX power supply (minimum recommended wattage: 200 watts; 235W for a fully-configured system) can supply at least 20 amperes on the +5-volt lead and at least 10mA (750mA recommended) on the +5-volt standby lead (+5VSB). Your system may become unstable/unreliable and may experience difficulty in powering up if your power supply is inadequate. For Wake-On-LAN support, your ATX power supply must supply at least 750mA +5VSB.

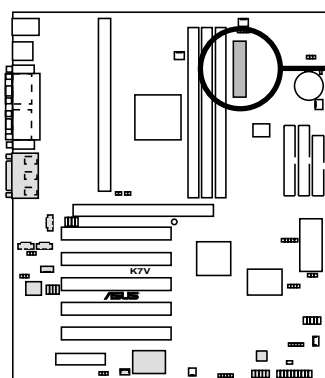

K7V ATX Power Connector

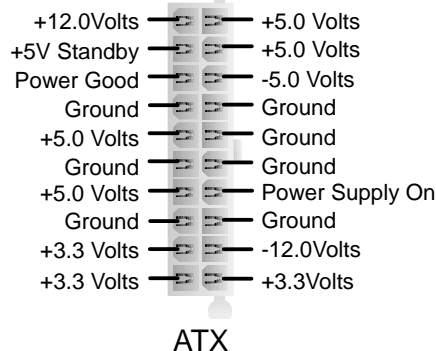

3. HARDWARE SETUP

20) USB Connector Set (10-1 pin USBPORT)

If the USB Ports on the back panels are inadequate, a USB connector set is available midboard. If you want to use this connector, you need to use the bundled external connector set. The external connector set connects to the 10-1 pin block and mounts to an open slot on your computer's chassis. For more peripheral connectivity, two additional USB ports are supported midboard.

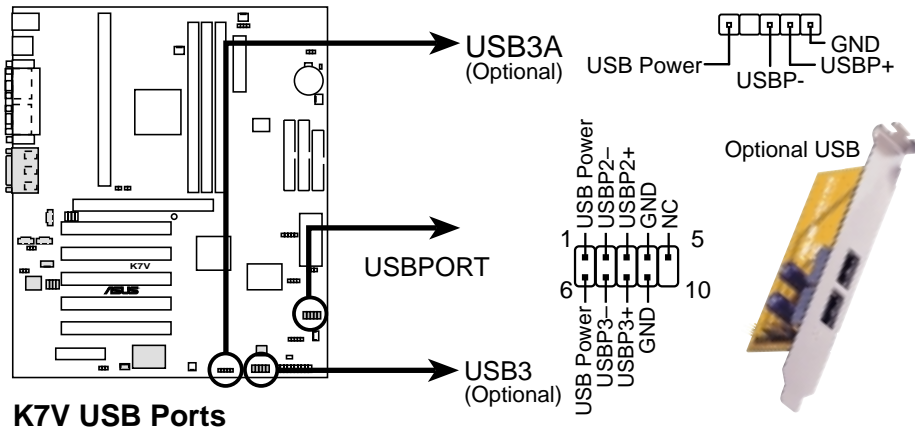

K7V USB Ports

21) Digital Audio Interface Connector (3-pin SPDIFOUT) (optional)

This optional connector is the digital link between the motherboard and your devices, such as CD player, sampler, or DAT recorder. It allows the digital transmission of audio data in SPDIF (Sony/Philips Digital Interface) format.

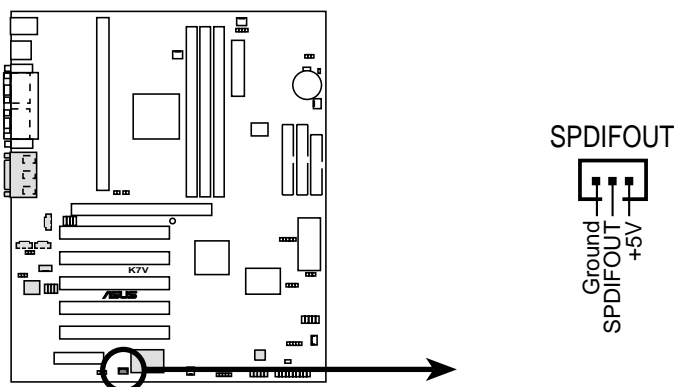

K7V Audio Digital Interface Connector

3. HARDWARE SETUP

The following is for items 22–27 (next page)

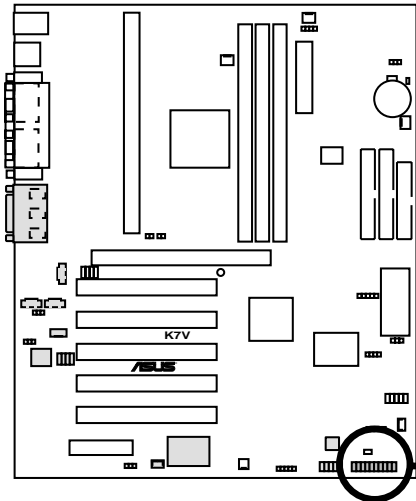

K7V System Panel Connectors

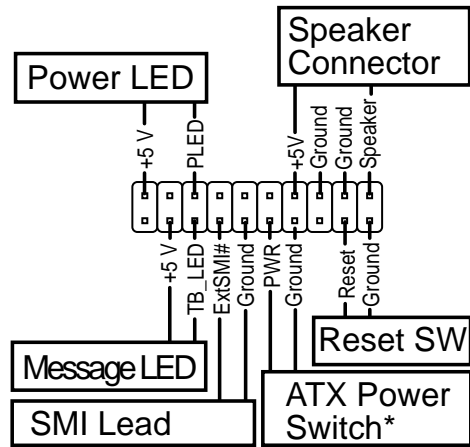

* Requires an ATX power supply.

3. HARDWARE SETUP

22) System Warning Speaker Connector (4-pin SPEAKER)

This 4-pin connector connects to the case-mounted speaker. Two sources (LINE_OUT and SPEAKER) will allow you to hear system beeps and warnings. Only SPEAKER will allow you to hear system beeps before the integrated audio has been properly initialized.

23) System Power LED Lead (3-1 pin PWRLED)

This 3-1 pin connector connects the system power LED, which lights when the system is powered on and blinks when it is in sleep mode.

24) System Message LED Lead (2-pin MSG.LED)

This indicates whether a message has been received from a fax/modem. The LED will remain lit when there is no signal and blink when there is data received. This function requires an ACPI OS and driver support.

25) Reset Switch Lead (2-pin RESET)

This 2-pin connector connects to the case-mounted reset switch for rebooting your computer without having to turn off your power switch. This is a preferred method of rebooting to prolong the life of the system's power supply.

26) ATX Power Switch Lead (2-pin PWRSW)

The system power is controlled by a momentary switch connected to this lead. Pressing the button once will switch the system between ON and SOFT OFF. Pushing the switch while in the ON mode for more than 4 seconds will turn the system off. The system power LED shows the status of the system's power.

27) System Management Interrupt Lead (2-pin SMI)

This allows the user to manually place the system into a suspend mode or "Green" mode, where system activity is decreased to save electricity and expand the life of certain components when the system is not in use. This 2-pin connector connects to the case-mounted suspend switch. If you do not have a switch for the connector, you may use the "Turbo Switch." SMI is activated when it detects a *short to open* moment and therefore leaving it shorted will not cause any problems. This may require one or two presses depending on the position of the switch. Wake-up can be controlled by settings in the BIOS but the keyboard will always allow wake-up (the SMI lead cannot wake up the system).

3. HARDWARE SETUP

3.9 Starting Up the First Time

1. After all connections are made, close the system case cover.
2. Be sure that all switches are off (in some systems, marked with ○).
3. Connect the power supply cord into the power supply located on the back of your system case according to your system user's manual.
4. Connect the power cord into a power outlet that is equipped with a surge protector.
5. You may then turn on your devices in the following order:
 - a. Your monitor
 - b. External SCSI devices (starting with the last device on the chain)
 - c. Your system power. For ATX power supplies, you need to switch on the power supply as well as press the ATX power switch on the front of the case.
6. The power LED on the front panel of the system case will light. For ATX power supplies, the system LED will light when the ATX power switch is pressed. The LED on the monitor may light up or switch between orange and green after the system's if it complies with "green" standards or if it has a power standby feature. The system will then run power-on tests. While the tests are running, the BIOS will alarm beeps or additional messages will appear on the screen. If you do not see anything within 30 seconds from the time you turn on the power, the system may have failed a power-on test. Recheck your jumper settings and connections or call your retailer for assistance.

Award BIOS Beep Codes

Beep	Meaning
One short beep when displaying logo	No error during POST
Long beeps in an endless loop	No DRAM installed or detected
One long beep followed by three short beeps	Video card not found or video card memory bad
High frequency beeps when system is working	CPU overheated System running at a lower frequency

3. HARDWARE SETUP

7. During power-on, hold down <Delete> to enter BIOS setup. Follow the instructions in **4. BIOS SETUP**.

- * **Powering Off your computer:** You must first exit or shut down your operating system before switching off the power switch. For ATX power supplies, you can press the ATX power switch after exiting or shutting down your operating system. If you use Windows 9X, click the **Start** button, click **Shut Down**, and then click **Shut down the computer?** The power supply should turn off after Windows shuts down.

NOTE: The message “You can now safely turn off your computer” will not appear when shutting down with ATX power supplies.

4. BIOS SETUP

4.1 Managing and Updating Your BIOS

4.1.1 Upon First Use of the Computer System

It is recommended that you save a copy of the original motherboard BIOS along with a Flash Memory Writer utility (AFLASH.EXE) to a bootable floppy disk in case you need to reinstall the BIOS later. **AFLASH.EXE** is a Flash Memory Writer utility that updates the BIOS by uploading a new BIOS file to the programmable flash ROM on the motherboard. This file works only in DOS mode. To determine the BIOS version of your motherboard, check the last four numbers of the code displayed on the upper left-hand corner of your screen during bootup. Larger numbers represent a newer BIOS file.

1. Type **FORMAT A:/S** at the DOS prompt to create a bootable system floppy disk. **DO NOT** copy AUTOEXEC.BAT & CONFIG.SYS to the disk.
2. Type **COPY D:\AFLASH\AFLASH.EXE A:** (assuming D is your CD-ROM drive) to copy AFLASH.EXE to the just created boot disk.

NOTE: AFLASH works only in DOS mode. It will not work with DOS prompt in Windows and will not work with certain memory drivers that may be loaded when you boot from your hard drive. It is recommended that you reboot using a floppy.

3. Reboot your computer from the floppy disk. **NOTE:** BIOS setup must specify “Floppy” as the first item in the boot sequence.
4. In DOS mode, type **A:\AFLASH <Enter>** to run AFLASH.



```
ASUS ACPI BIOS
FLASH MEMORY WRITER V1.24
Copyright (C) 1994-99, ASUSTeK COMPUTER INC.

Flash Memory: Winbond W29C020 or SST 25E020 or Intel B28020B

Current BIOS Version: ASUS XXX-XX ACPI BIOS Revision 100X
BIOS Model          : XXX-XX
BIOS Built Date     : 09/25/98

Choose one of the following:

1. Save Current BIOS To File
2. Update BIOS Including Boot Block and ESCD

Enter choice: [1]

Press ESC To Exit
```

IMPORTANT! If “unknown” is displayed after **Flash Memory:**, the memory chip is either not programmable or is not supported by the ACPI BIOS and therefore, cannot be programmed by the Flash Memory Writer utility.

4. BIOS SETUP

5. Select **1. Save Current BIOS to File** from the Main menu and press <Enter>. The **Save Current BIOS To File** screen appears.

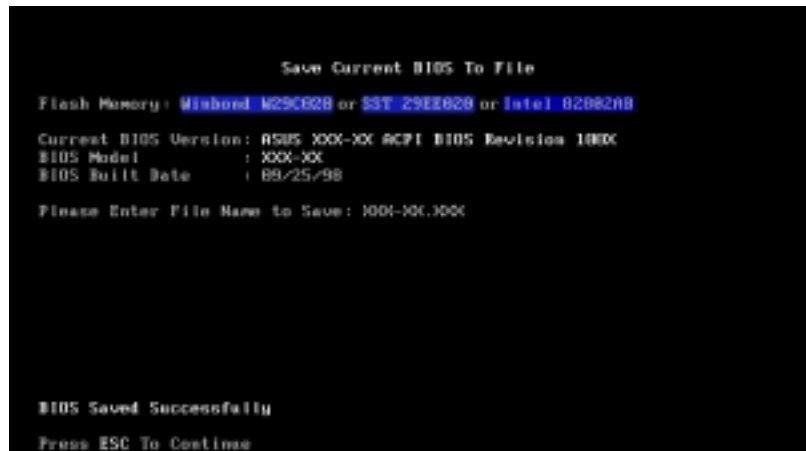

6. Type a filename and the path, for example, **A:\XXX-XX.XXX** and then press <Enter>.

4.1.2 Updating BIOS Procedures

WARNING! Only update your BIOS if you have problems with your motherboard and you know that the new BIOS revision will solve your problems. Careless updating can result in your motherboard having more problems!

1. Download an updated ASUS BIOS file from the Internet (WWW or FTP) (see **ASUS CONTACT INFORMATION** on page 3 for details) and save to the disk you created earlier.
2. Boot from the disk you created earlier.
3. At the “A:\” prompt, type **AFLASH** and then press <Enter>.
4. At the **Main Menu**, type **2** and then press <Enter>. The **Update BIOS Including Boot Block and ESCD** screen appears.
5. Type the filename of your new BIOS and the path, for example, **A:\XXX-XX.XXX**, and then press <Enter>.

NOTE: To cancel this operation, press <Enter>.

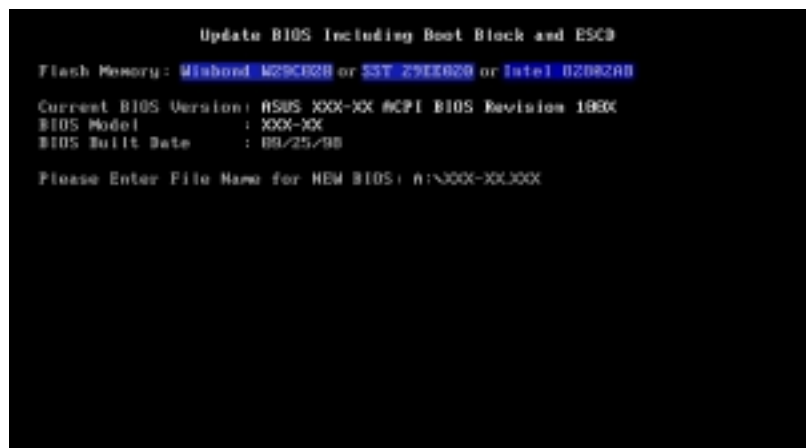

4. BIOS SETUP

6. When prompted to confirm the BIOS update, press **Y** to start the update.

```
Update BIOS Including Boot Block and ESCD
Flash Memory: Winbond W29C020 or SST 29C020 or Intel B28020
BIOS Version
(CURRENT) ASUS 1001-100 ACPI BIOS Revision 100X
(Clast.asd) ASUS 1001-100 ACPI BIOS Revision 100X
BIOS Model
(CURRENT) 1001-100
(Clast.asd) 1001-100
Date of BIOS Built
(CURRENT) 08/25/98
(IN000L1000) 05/25/98
Notice: Boot Block is different. Check sum of 1001.010 is F25E.
Are you sure (Y/N) ? [Y]
Press ESC To Return to Main Menu
```

7. The utility starts to program the new BIOS information into the flash ROM. The boot block will be updated automatically only when necessary. This will minimize the chance that a failed update will prevent your system from booting up. When the programming is finished, *Flashed Successfully* will be displayed.

```
Update BIOS Including Boot Block and ESCD
Flash Memory: Winbond W29C020 or SST 29C020 or Intel B28020
BIOS Version
(CURRENT) ASUS 1001-100 ACPI BIOS Revision 100X
(Clast.asd) ASUS 1001-100 ACPI BIOS Revision 100X
BIOS Model
(CURRENT) 1001-100
(Clast.asd) 1001-100
Date of BIOS Built
(CURRENT) 08/25/98
(IN000L1000) 05/25/98
Notice: Boot Block is different. Check sum of 1001.010 is F25E.
Are you sure (Y/N) ? [Y]
Block Erasing -- Done
Programming -- 3FFFF
Flashed Successfully
Press ESC To Continue
```

8. Follow the onscreen instructions to continue.

```
ASUS ACPI BIOS
FLASH MEMORY WRITER V1.20
Copyright (C) 1994-99, ASUSTeK COMPUTER INC.
Flash Memory: Winbond W29C020 or SST 29C020 or Intel B28020
Current BIOS Version: ASUS 1001-100 ACPI BIOS Revision 100X
BIOS Model : 1001-100
BIOS Built Date : 05/25/98
Choose one of the following:
1. Save Current BIOS To File
2. Update BIOS Including Boot Block and ESCD
Enter choice: [1]
You have flashed the EPROM. It is recommended that you turn off
the power, enter SETUP and Load Setup Defaults to have CMOS
updated with new BIOS when exits.
Press ESC To Exit
```

WARNING! If you encounter problems while updating the new BIOS, DO NOT turn off your system since this might prevent your system from booting up. Just repeat the process, and if the problem still persists, update the original BIOS file you saved to disk above. If the Flash Memory Writer utility was not able to successfully update a complete BIOS file, your system may not be able to boot up. If this happens, your system will need servicing.

4. BIOS SETUP

(This page was intentionally left blank.)

4. BIOS SETUP

4.2 BIOS Setup Program

This motherboard supports a programmable EEPROM that can be updated using the provided utility as described in *4.1 Managing and Updating Your BIOS*.

The utility is used if you are installing a motherboard, reconfiguring your system, or prompted to “**Run Setup**”. This section describes how to configure your system using this utility.

Even if you are not prompted to use the Setup program, at some time in the future you may want to change the configuration of your computer. For example, you may want to enable the Security Password Feature or make changes to the power management settings. It will then be necessary to reconfigure your system using the BIOS Setup program so that the computer can recognize these changes and record them in the CMOS RAM of the EEPROM.

The EEPROM on the motherboard stores the Setup utility. When you start up the computer, the system provides you with the opportunity to run this program. This appears during the Power-On Self Test (POST). Press <Delete> to call up the Setup utility. If you are a little bit late in pressing the mentioned key, POST will continue with its test routines, thus preventing you from calling up Setup. If you still need to call Setup, restart the system by pressing <Ctrl> + <Alt> + <Delete>, or by pressing the Reset button on the system chassis. You can also restart by turning the system off and then back on again. But do so only if the first two methods fail.

The Setup program has been designed to make it as easy to use as possible. It is a menu-driven program, which means you can scroll through the various sub-menus and make your selections among the predetermined choices.

To access the BIOS Setup program, press the <Delete> key after the computer has run through its POST.

NOTE: Because the BIOS software is constantly being updated, the following BIOS screens and descriptions are for reference purposes only and may not reflect your BIOS screens exactly.

4. BIOS SETUP

4.2.1 BIOS Menu Bar

The top of the screen has a menu bar with the following selections:

- MAIN** Use this menu to make changes to the basic system configuration.
- ADVANCED** Use this menu to enable and make changes to the advanced features.
- POWER** Use this menu to configure and enable Power Management features.
- BOOT** Use this menu to configure the default system device used to locate and load the Operating System.
- EXIT** Use this menu to exit the current menu or specify how to exit the Setup program.

To access the menu bar items, press the right or left arrow key on the keyboard until the desired item is highlighted.

4.2.2 Legend Bar

At the bottom of the Setup screen you will notice a legend bar. The keys in the legend bar allow you to navigate through the various setup menus. The following table lists the keys found in the legend bar with their corresponding alternates and functions.

Navigation Key(s)	Function Description
<F1> or <Alt + H>	Displays the General Help screen from anywhere in the BIOS Setup
<Esc>	Jumps to the Exit menu or returns to the main menu from a sub-menu
← or → (keypad arrow)	Selects the menu item to the left or right
↑ or ↓ (keypad arrow)	Moves the highlight up or down between fields
- (minus key)	Scrolls backward through the values for the highlighted field
+ (plus key) or spacebar	Scrolls forward through the values for the highlighted field
<Enter>	Brings up a selection menu for the highlighted field
<Home> or <PgUp>	Moves the cursor to the first field
<End> or <PgDn>	Moves the cursor to the last field
<F5>	Resets the current screen to its Setup Defaults
<F10>	Saves changes and exits Setup

4. BIOS SETUP

General Help

In addition to the Item Specific Help window, the BIOS setup program also provides a General Help screen. This screen can be called up from any menu by simply pressing <F1> or the <Alt> + <H> combination. The General Help screen lists the legend keys with their corresponding alternates and functions.

Saving Changes and Exiting the Setup Program

See *4.7 Exit Menu* for detailed information on saving changes and exiting the setup program.

Scroll Bar

When a scroll bar appears to the right of a help window, it indicates that there is more information to be displayed that will not fit in the window. Use <PgUp> and <PgDn> or the up and down arrow keys to scroll through the entire help document. Press <Home> to display the first page, press <End> to go to the last page. To exit the help window, press <Enter> or <Esc>.

Sub-Menu

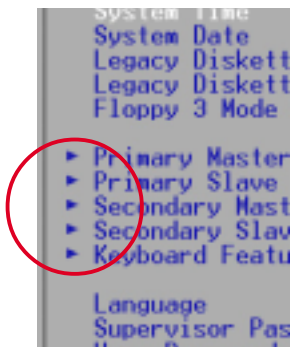

Note that a right pointer symbol (as shown in the left view) appears to the left of certain fields. This pointer indicates that a sub-menu can be launched from this field. A sub-menu contains additional options for a field parameter. To call up a sub-menu, simply move the highlight to the field and press <Enter>. The sub-menu will then immediately appear. Use the legend keys to enter values and move from field to field within a sub-menu just as you would within a menu. Use the <Esc> key to return to the main menu.

Take some time to familiarize yourself with each of the legend keys and their corresponding functions. Practice navigating through the various menus and sub-menus. If you accidentally make unwanted changes to any of the fields, use the set default hot key <F5>. While moving around through the Setup program, note that explanations appear in the Item Specific Help window located to the right of each menu. This window displays the help text for the currently highlighted field.

NOTE: The item heading in square brackets represents the default setting for that field.

4. BIOS SETUP

4.3 Main Menu

When the Setup program is accessed, the following screen appears:

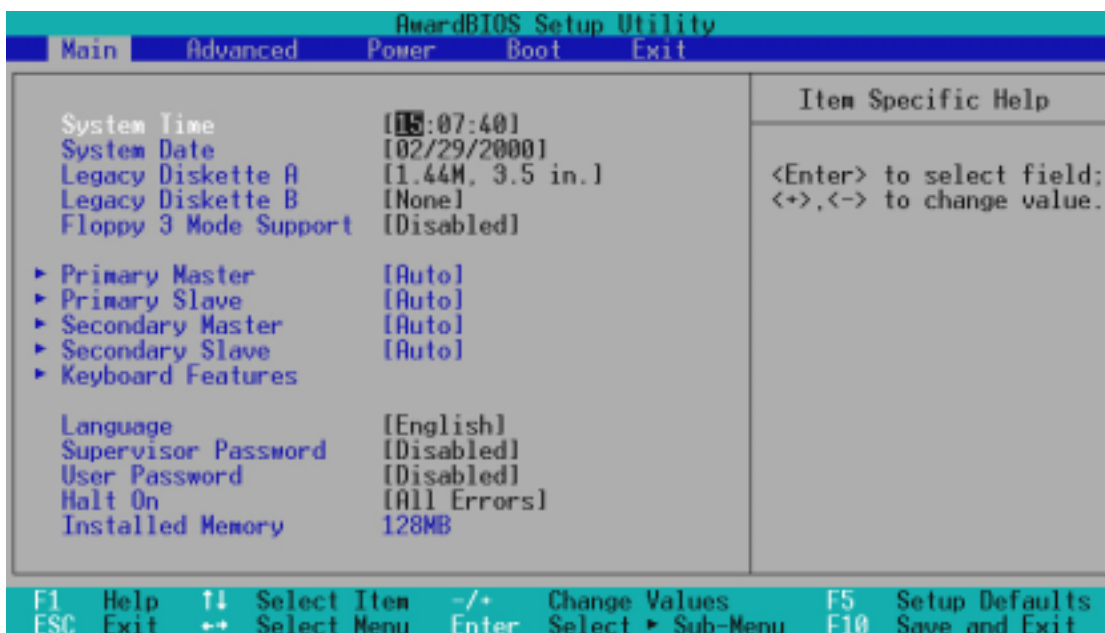

System Time [XX:XX:XX]

Sets your system to the time that you specify (usually the current time). The format is hour, minute, second. Valid values for hour, minute and second are **Hour: (00 to 23)**, **Minute: (00 to 59)**, **Second: (00 to 59)**. Use the <Tab> or <Shift> + <Tab> keys to move between the hour, minute, and second fields.

System Date [XX/XX/XXXX]

Sets your system to the date that you specify (usually the current date). The format is month, day, year. Valid values for month, day, and year are **Month: (1 to 12)**, **Day: (1 to 31)**, **Year: (100 year range)**. Use the <Tab> or <Shift> + <Tab> keys to move between the month, day, and year fields.

Legacy Diskette A [1.44M, 3.5 in.], Legacy Diskette B [None]

Sets the type of floppy drives installed. Configuration options: [None] [360K, 5.25 in.] [1.2M, 5.25 in.] [720K, 3.5 in.] [1.44M, 3.5 in.] [2.88M, 3.5 in.]

Floppy 3 Mode Support [Disabled]

This is required to support older Japanese floppy drives. Floppy 3 Mode support will allow reading and writing of 1.2MB (as opposed to 1.44MB) on a 3.5-inch diskette. Configuration options: [Disabled] [Drive A] [Drive B] [Both]

4. BIOS SETUP

4.3.1 Primary & Secondary Master/Slave

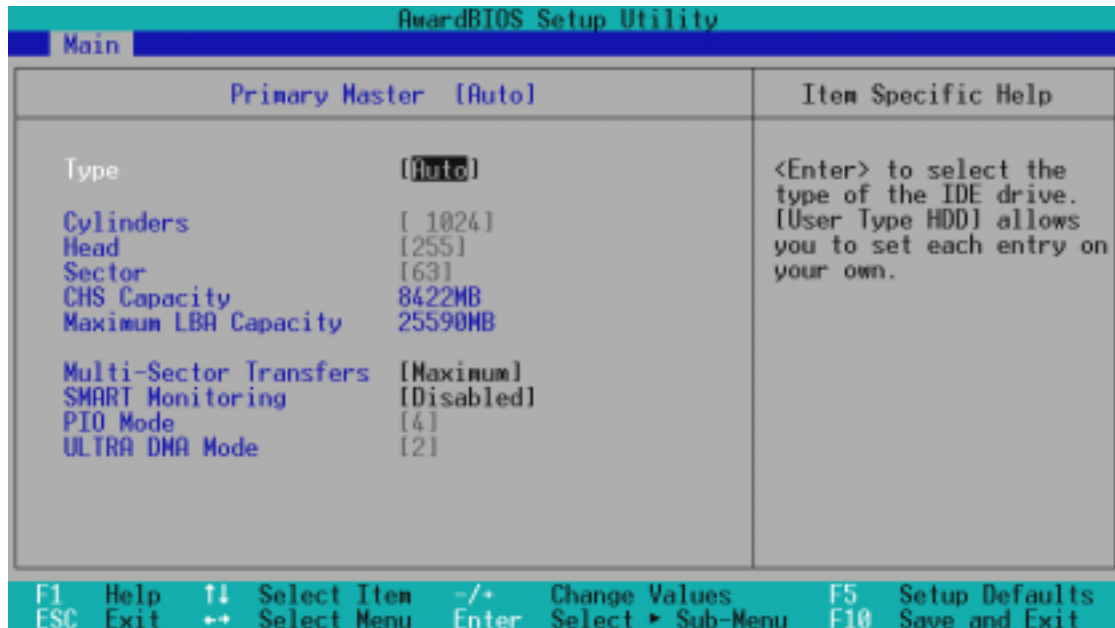

NOTE: Before attempting to configure a hard disk drive, make sure you have the configuration information supplied by the manufacturer of the drive. Incorrect settings may cause your system to not recognize the installed hard disk. To allow the BIOS to detect the drive type automatically, select [Auto].

Type [Auto]

Select [Auto] to automatically detect an IDE hard disk drive. If automatic detection is successful, the correct values will be filled in for the remaining fields on this sub-menu. If automatic detection fails, your hard disk drive may be too old or too new. You can try updating your BIOS or enter the IDE hard disk drive parameters manually.

NOTE: After the IDE hard disk drive information has been entered into BIOS, new IDE hard disk drives must be partitioned (such as with FDISK) and then formatted before data can be read from and write on. Primary IDE hard disk drives must have its partition set to *active* (also possible with FDISK).

Other options for the **Type** field are:

[None] - to disable IDE devices

4. BIOS SETUP

IMPORTANT: If your hard disk was already formatted on an older previous system, incorrect parameters may be detected. You will need to enter the correct parameters manually or use low-level format if you do not need the data stored on the hard disk. If the parameters listed differ from the ones used when the disk was formatted, the disk will not be readable. If the auto-detected parameters do not match the ones that should be used for your disk, you should enter the correct ones manually by setting [User Type HDD].

[User Type HDD]

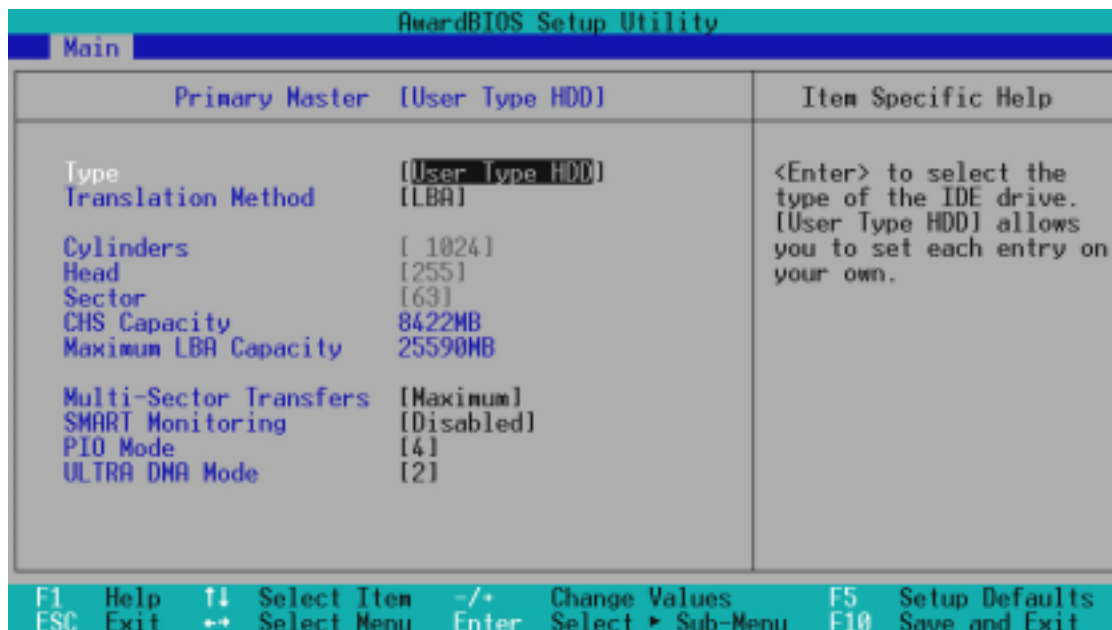

Manually enter the number of cylinders, heads and sectors per track for your drive. Refer to your drive documentation or look on the drive for this information. If no drive is installed or if you are removing a drive and not replacing it, select [None].

Translation Method [LBA]

Select the hard disk drive type in this field. When Logical Block Addressing is enabled, 28-bit addressing of the hard drive is used without regard for cylinders, heads, or sectors. Note that LBA Mode is necessary for drives with greater than 504MB in storage capacity. Configuration options: [LBA] [LARGE] [Normal] [Match Partition Table] [Manual]

Cylinders

This field configures the number of cylinders. Refer to your drive documentation to determine the correct value to enter into this field. **NOTE:** To make changes to this field, the **Type** field must be set to [User Type HDD] and the **Translation Method** field must be set to [Manual].

4. BIOS SETUP

Head

This field configures the number of read/write heads. Refer to your drive documentation to determine the correct value to enter into this field. **NOTE:** To make changes to this field, the **Type** field must be set to [User Type HDD] and the **Translation Method** field must be set to [Manual].

Sector

This field configures the number of sectors per track. Refer to your drive documentation to determine the correct value to enter into this field. **NOTE:** To make changes to this field, the **Type** field must be set to [User Type HDD] and the **Translation Method** field must be set to [Manual].

CHS Capacity

This field shows the drive's maximum CHS capacity calculated automatically by the BIOS from the drive information you entered.

Maximum LBA Capacity

This field shows the drive's maximum LBA capacity calculated automatically by the BIOS from the drive information you entered.

Multi-Sector Transfers [Maximum]

This option automatically sets the number of sectors per block to the highest number supported by the drive. This field can also be configured manually. Note that when this field is automatically configured, the set value may not always be the fastest value for the drive. Refer to the documentation that came with your hard drive to determine the optimal value and set it manually. **NOTE:** To make changes to this field, the **Type** field must be set to [User Type HDD]. Configuration options: [Disabled] [2 Sectors] [4 Sectors] [8 Sectors] [16 Sectors] [32 Sectors] [Maximum]

SMART Monitoring [Disabled]

This allows the enabling or disabling of the S.M.A.R.T. (Self-Monitoring, Analysis and Reporting Technology) system which utilizes internal hard disk drive monitoring technology. This feature is normally disabled because system resources used in this feature may decrease system performance. Configuration options: [Disabled] [Enabled]

PIO Mode [4]

This option lets you set a PIO (Programmed Input/Output) mode for the IDE device. Modes 0 through 4 provide successively increased performance. Configuration options: [0] [1] [2] [3] [4]

Ultra DMA Mode [Disabled]

Ultra DMA capability allows improved transfer speeds and data integrity for compatible IDE devices. Set to [Disabled] to suppress Ultra DMA capability. **NOTE:** To make changes to this field, the **Type** field must be set to [User Type HDD]. Configuration options: [0] [1] [2] [3] [4] [Disabled]

4. BIOS SETUP

Other options for “Type:” are:

[CD-ROM] - for IDE CD-ROM drives

[LS-120] - for LS-120 compatible floppy disk drives

[ZIP-100] - for ZIP-100 compatible disk drives

[MO] - for IDE magneto optical disk drives

[Other ATAPI Device] - for IDE devices not listed here

After using the legend keys to make your selections on this sub-menu, press the <Esc> key to exit back to the Main menu. When the Main menu appears, you will notice that the drive size appear in the field for the hard disk drive that you just configured.

4.3.2 Keyboard Features

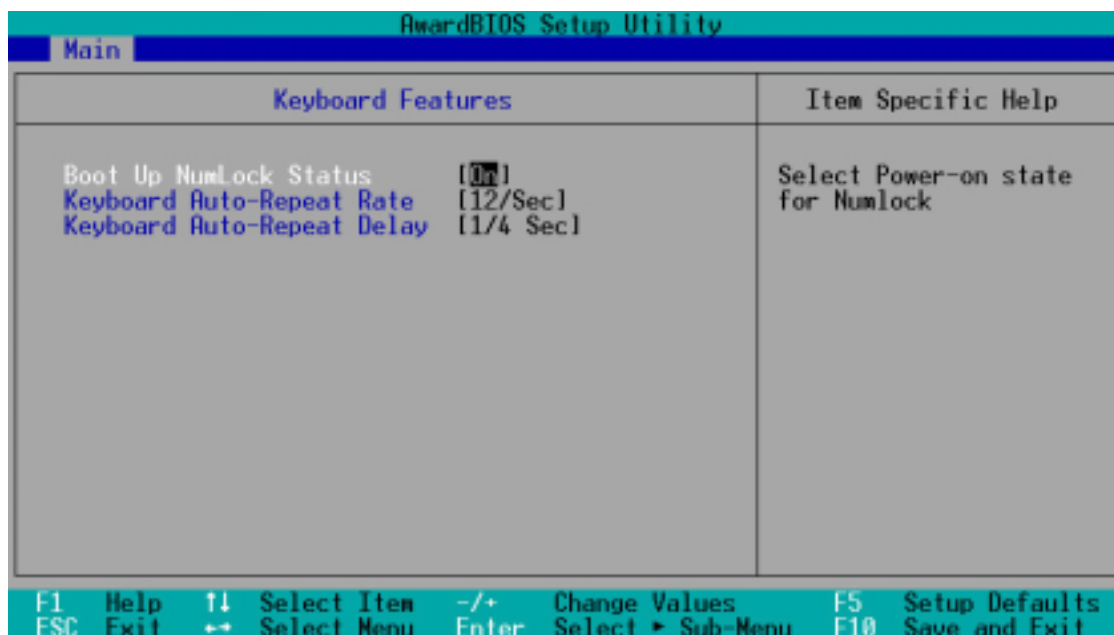

Boot Up NumLock Status [On]

This field enables users to activate the Number Lock function upon system boot. Configuration options: [Off] [On]

Keyboard Auto-Repeat Rate [12/Sec]

This controls the speed at which the system registers repeated keystrokes. Options range from 6 to 30 characters per second. Configuration options: [6/Sec] [8/Sec] [10/Sec] [12/Sec] [15/Sec] [20/Sec] [24/Sec] [30/Sec]

Keyboard Auto-Repeat Delay [1/4 Sec]

This field sets the time interval for displaying the first and second characters. Configuration options: [1/4 Sec] [1/2 Sec] [3/4 Sec] [1 Sec]

4. BIOS SETUP

Language [English]

This allows selection of the BIOS' displayed language. Currently only English is available.

Supervisor Password [Disabled] / User Password [Disabled]

These fields allow you to set the passwords. To set the password, highlight the appropriate field and press <Enter>. Type in a password and press <Enter>. You can type up to eight alphanumeric characters. Symbols and other keys are ignored. To confirm the password, type the password again and press the <Enter>. The password is now set to [Enabled]. This password allows full access to the BIOS Setup menus. To clear the password, highlight this field and press <Enter>. The same dialog box as above will appear. Press <Enter> and the password will be set to [Disabled].

A Note about Passwords

The BIOS Setup program allows you to specify passwords in the Main menu. The passwords control access to the BIOS during system startup. The passwords are not case sensitive. In other words, it makes no difference whether you enter a password using upper or lowercase letters. The BIOS Setup program allows you to specify two separate passwords: a Supervisor password and a User password. When disabled, anyone may access all BIOS Setup program functions. When enabled, the Supervisor password is required for entering the BIOS Setup program and having full access to all configuration fields.

Forgot the Password?

If you forgot the password, you can clear the password by erasing the CMOS Real Time Clock (RTC) RAM. The RAM data containing the password information is powered by the onboard button cell battery. To erase the RTC RAM: (1) Unplug your computer, (2) Short the solder points, (3) Turn ON your computer, (4) Hold down <Delete> during bootup and enter BIOS setup to re-enter user preferences.

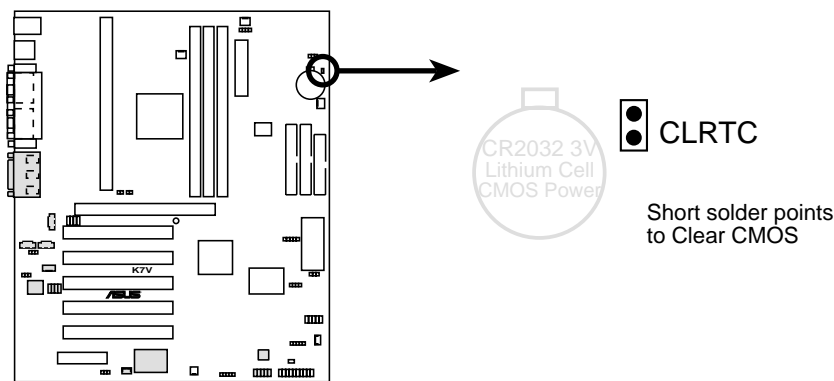

K7V Clear RTC RAM

Halt On [All Errors]

This field determines which types of errors will cause the system to halt. Configuration options: [All Errors] [No Error] [All but Keyboard] [All but Disk] [All but Disk/Keyboard]

Installed Memory [XXX MB]

This display-only field displays the amount of conventional memory detected by the system during bootup. You do not need to make changes to this field.

4. BIOS SETUP

4.4 Advanced Menu

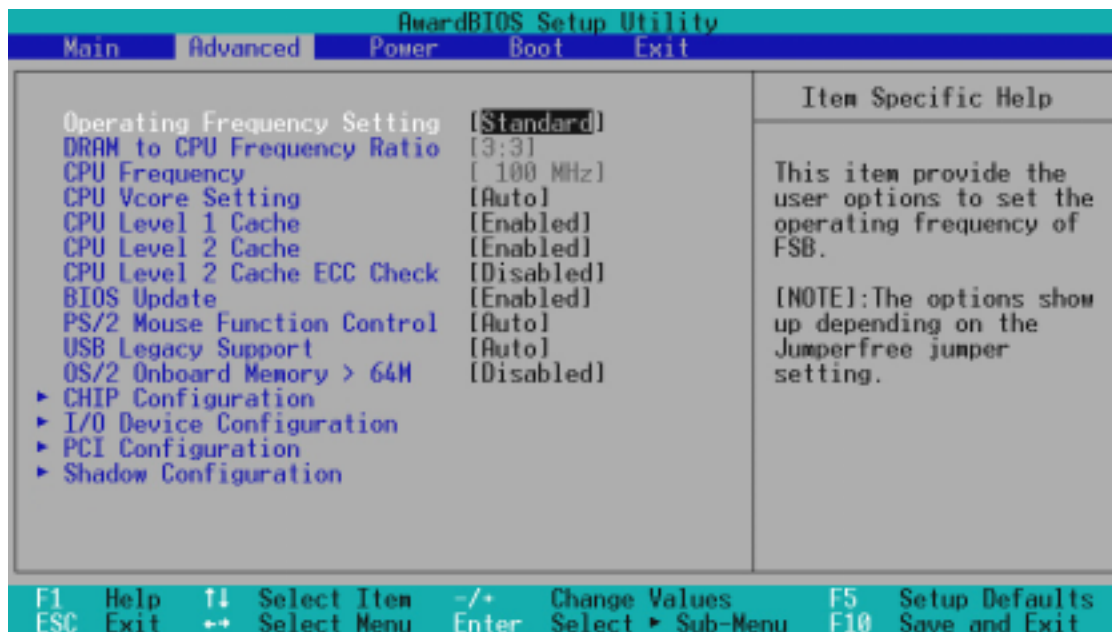

Operating Frequency Setting [Standard]

When the motherboard is set to JumperFree™ mode, this field allows you to configure the external frequency of your CPU. Select [User Define] if you want to make changes to the **CPU Frequency** field. When [Standard] is selected, **CPU (external) Frequency** will be fixed at 100MHz. Configuration options: [Standard] [User Define]

DRAM to CPU Frequency Ratio

This field determines whether the memory clock frequency is set to be in synchronous or asynchronous mode with respect to the **CPU Frequency**. This must be set in conjunction with **CPU (external) Frequency** to match the speed of your SDRAM. Configuration options: [3:3] [4:3]

CPU Frequency

(when Operating Frequency Setting is set to [User Define])

This feature tells the clock generator what frequency to send to the system bus and PCI bus. The bus frequency (external frequency) multiplied by the bus multiple equals the **CPU speed** (the CPU's internal frequency). Note that selecting a frequency higher than what the CPU manufacturer recommends may cause the system to hang or crash. See *System Hangup* later in this section.

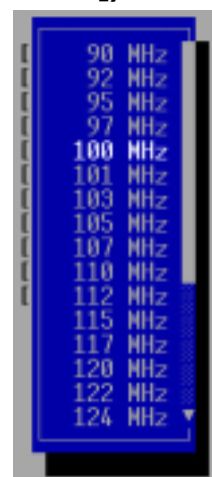

4. BIOS SETUP

CPU Vcore Setting [Auto]

In JumperFree mode, this feature allows you select the core voltage supplied to the CPU. Leave on [Auto] to use the CPU default setting. If you want to set it manually, select [User Define], go to the subsequent **CPU Vcore** field, and refer to your CPU documentation to complete the configuration.

CPU Vcore

In JumperFree mode, when **CPU Vcore Setting** is set to [User Define], this field allows you to manually select the core voltage supplied to the CPU. The picture shown here provides only examples of possible Vcore ranges.

CPU Vcore



CPU Level 1 Cache, CPU Level 2 Cache [Enabled]

These fields allow you to choose from the default of [Enabled] or choose [Disabled] to turn on or off the CPU's Level 1 and Level 2 built-in cache. Configuration options: [Disabled] [Enabled]

CPU Level 2 Cache ECC Check [Disabled]

This function controls the ECC capability in the CPU level 2 cache. Configuration options: [Disabled] [Enabled]

BIOS Update [Enabled]

This functions as an update loader integrated into the BIOS to supply the processor with the required data. In the default position of [Enabled], the BIOS will load the update on all processors during system bootup. Configuration options: [Disabled] [Enabled]

PS/2 Mouse Function Control [Auto]

The default of [Auto] allows the system to detect a PS/2 mouse on startup. If detected, IRQ12 will be used for the PS/2 mouse. IRQ12 will be reserved for expansion cards only if a PS/2 mouse is not detected. [Enabled] will always reserve IRQ12, whether on startup a PS/2 mouse is detected or not. Configuration options: [Enabled] [Auto]

USB Legacy Support [Auto]

This motherboard supports Universal Serial Bus (USB) devices. The default of [Auto] allows the system to detect a USB device on startup. If detected, the USB controller will be enabled. If not detected, the USB controller will be disabled. When this field is set to [Disabled], the USB controller is disabled no matter whether you are using a USB device or not. Configuration options: [Disabled] [Enabled] [Auto]

OS/2 Onboard Memory > 64M [Disabled]

When using OS/2 operating systems with installed DRAM of greater than 64MB, you need to set this option to [Enabled]; otherwise, leave this on [Disabled]. Configuration options: [Disabled] [Enabled]

4. BIOS SETUP

Notes for JumperFree Mode

System Hangup

If your system crashes or hangs due to improper frequency settings, power OFF your system and restart. The system will start up in safe mode running at a DRAM-to-CPU frequency ratio of 3:3 and a bus speed of 100MHz. You will then be led to BIOS setup to adjust the configurations.

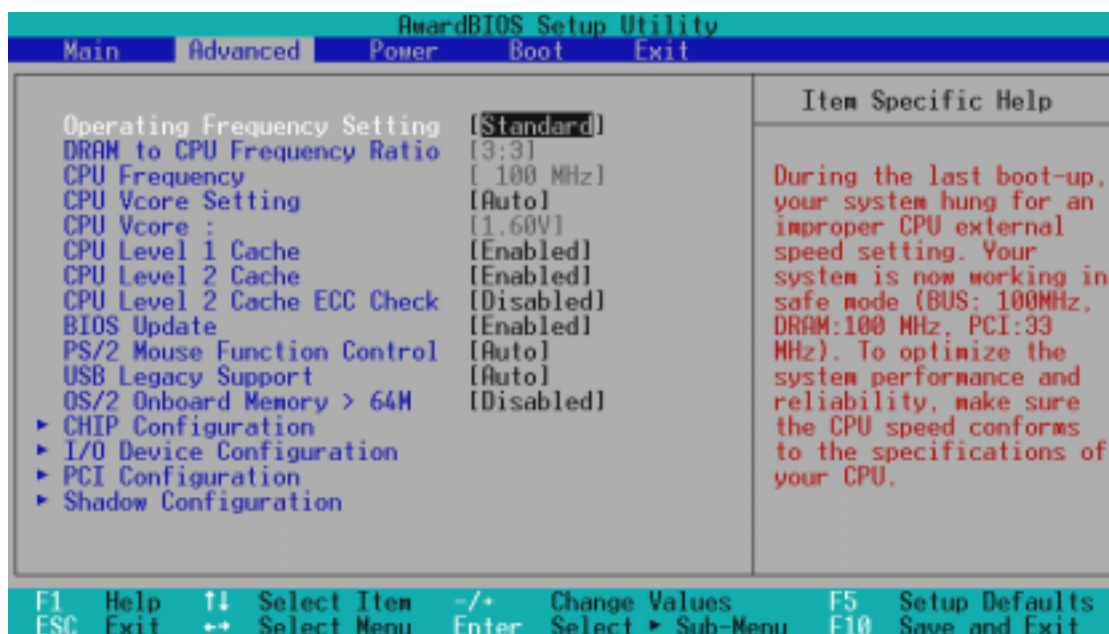

4. BIOS SETUP

4.4.1 Chip Configuration



Onboard PCI IDE Enable [Both]

You can select to enable the primary IDE channel, secondary IDE channel, both, or disable both channels. Configuration options: [Both] [Primary] [Secondary] [Disabled]

Spread Spectrum Control [Enabled]

Leave on default setting. Spread spectrum typically reduces system electromagnetic interference (EMI) by 8dB to 10dB.

AGP 4X Drive Strength [Auto]

Configuration options: [Auto] [Manual]

AGP Drive Strength P Ctrl [C]

Configuration options: [0] [1] [2]...[F]

AGP Drive Strenght N Ctrl [E]

Configuration options: [0] [1] [2]...[F]

AGP Fast Write [Disabled]

Configuration options: [Disabled] [Enabled]

SDRAM Configuration [By SPD]

This sets the optimal timings for SDRAM related fields, depending on the memory modules that you are using. Default setting is [By SPD], which configures the subsequent 3 items by reading the contents in the SPD (Serial Presence Detect) device. The EEPROM on the memory module stores critical parameter information about the module, such as memory type, size, speed, voltage interface, and module banks. Configuration options: [User Define] [By SPD]

4. BIOS SETUP

SDRAM CAS Latency

This controls the latency between the SDRAM read command and the time that the data actually becomes available. **NOTE:** This field will only be displayed when **SDRAM Configuration** is set to [User Define].

SDRAM RAS Precharge Time

This controls the idle clocks after issuing a precharge command to the SDRAM. **NOTE:** This field will only be displayed when **SDRAM Configuration** is set to [User Define].

SDRAM RAS to CAS Delay

This controls the latency between the SDRAM active command and the read/write command. **NOTE:** This field will only be displayed when **SDRAM Configuration** is set to [User Define].

Delayed Transaction [Enabled]

Enabled, this frees the PCI Bus when the CPU is accessing 8-bit ISA cards that normally consume about 50-60 PCI Clocks without PCI delayed transaction. Select [Disabled] for ISA cards that are not PCI 2.1 compliant. Configuration options: [Enabled] [Disabled]

PCI to DRAM Prefetch [Enabled]

Configuration options: [Disabled] [Enabled]

Byte Merge [Disabled]

To optimize the data transfer on PCI, this merges a sequence of individual memory writes (bytes or words) into a single 32-bit block of data. However, byte merging may only be done when the bytes within a data phase are in a prefetchable address range. Configuration options: [Disabled] [Enabled]

DRAM Read Latch Delay [0.5 ns]

Configuration options: [0.0 ns] [0.5 ns] [1.0 ns] [2.0 ns]

DRAM Interleave Setting [Auto]

Configuration options: [Auto] [Disabled]

Graphics Aperture Size [64MB]

This feature allows you to select the size of mapped memory for AGP graphic data. Configuration options: [4MB] [8MB] [16MB] [32MB] [64MB] [128MB] [256MB]

Video Memory Cache Mode [UC]

USWC (uncacheable, speculative write combining) is a new cache technology for the video memory of the processor. It can greatly improve the display speed by caching the display data. You must set this to UC (uncacheable) if your display card cannot support this feature; otherwise your system may not boot. Configuration options: [UC] [USWC]

4. BIOS SETUP

4.4.2 I/O Device Configuration

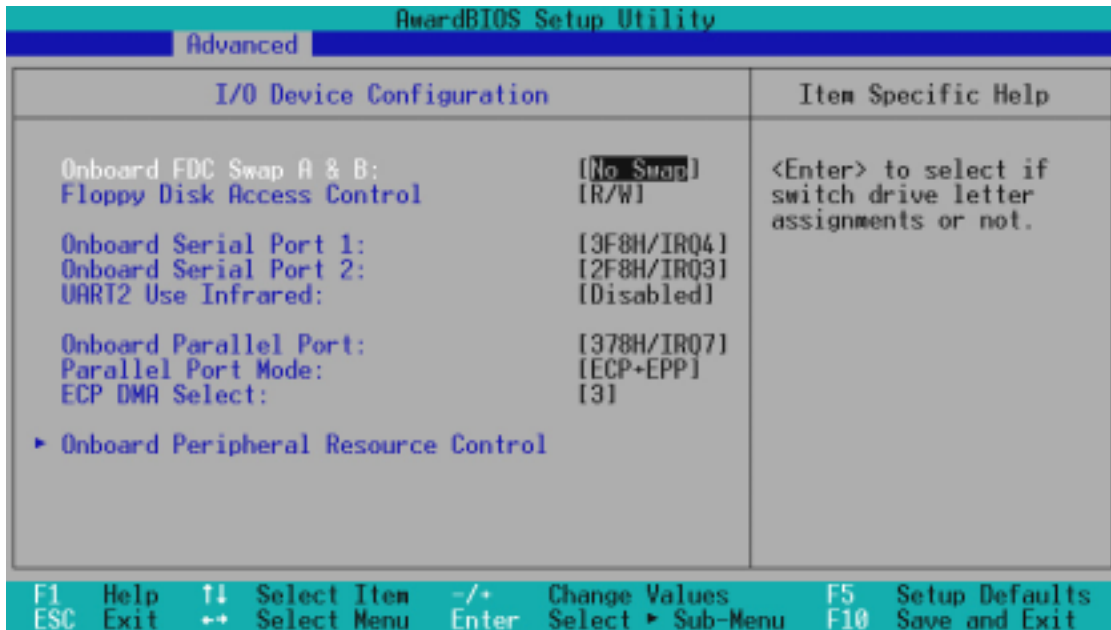

Onboard FDC Swap A & B [No Swap]

This field allows you to reverse the hardware drive letter assignments of your floppy disk drives. Configuration options: [No Swap] [Swap AB]

Floppy Disk Access Control [R/W]

When set to [Read Only], this field protects files from being copied to floppy disks by allowing reads from the floppy disk drive but not writes. The setup default [R/W] allows both reads and writes. Configuration options: [R/W] [Read Only]

Onboard Serial Port 1 [3F8H/IRQ4]

Onboard Serial Port 2 [2F8H/IRQ3]

These fields allow you to set the addresses for the onboard serial connectors. Serial Port 1 and Serial Port 2 must have different addresses. Configuration options: [3F8H/IRQ4] [2F8H/IRQ3] [3E8H/IRQ4] [2E8H/IRQ10] [Disabled]

UART2 Use Standard Infrared [Disabled]

When enabled, this field activates the onboard standard infrared feature and sets the second serial UART to support the infrared module connector on the motherboard. If your system already has a second serial port connected to the onboard COM2 connector, it will no longer work if you enable the infrared feature. See **IrDA-Compliant Infrared Module Connector** in *3.8 External Connectors*. Configuration options: [Disabled] [Enabled]

4. BIOS SETUP

Onboard Parallel Port [378H/IRQ7]

This field sets the address of the onboard parallel port connector. If you disable this feature, **Parallel Port Mode** and **ECP DMA Select** configurations will not be available. Configuration options: [Disabled] [378H/IRQ7] [278H/IRQ5]

Parallel Port Mode [ECP+EPP]

This field allows you to set the operation mode of the parallel port. [Normal] allows normal-speed operation but in one direction only; [EPP] allows bidirectional parallel port operation; [ECP] allows the parallel port to operate in bidirectional DMA mode; [ECP+EPP] allows normal speed operation in a two-way mode. Configuration options: [Normal] [ECP] [EPP] [ECP+EPP]

ECP DMA Select [3]

This field allows you to configure the parallel port DMA channel for the selected **ECP** mode. This selection is available only if you select [ECP] or [ECP+EPP] in **Parallel Port Mode** above. Configuration options: [1] [3] [Disabled]

Onboard Peripheral Resource Control

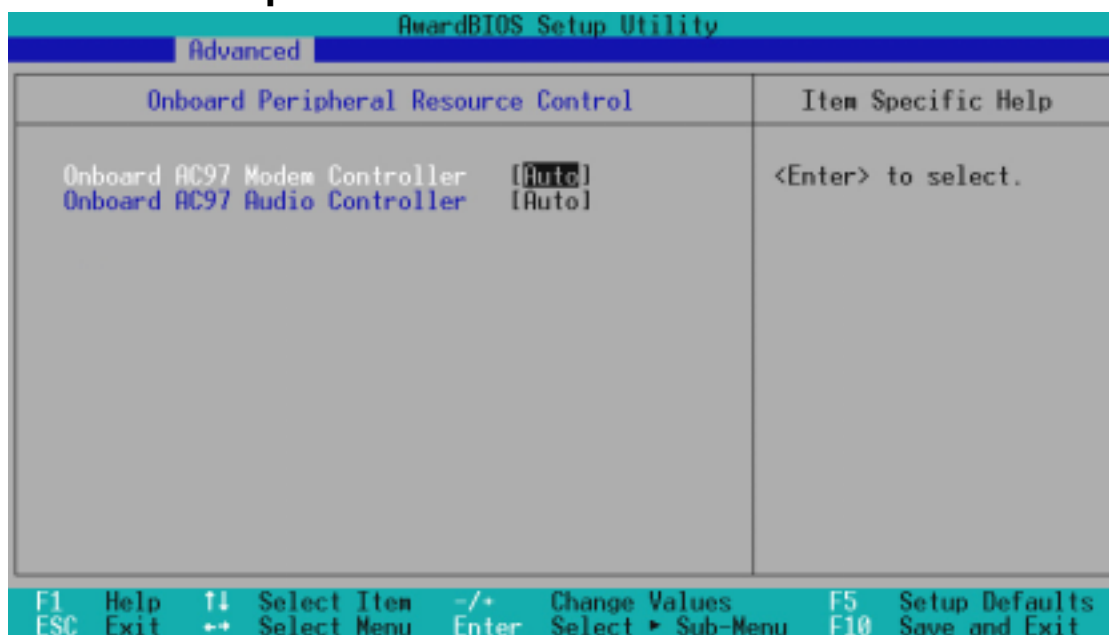

Onboard AC97 Modem Controller [Auto]

Onboard AC97 Audio Controller [Auto]

[Auto] allows the motherboard's BIOS to detect whether you are using any modem/audio device. If a modem/audio device is detected, the onboard modem/audio controller will be enabled; if no modem/audio device is detected, the onboard modem/audio controller will be disabled. If you have conflicts with the onboard modem/audio controller, you may set the appropriate field to [Disabled]. Configuration options: [Disabled] [Auto]

4. BIOS SETUP

For motherboards without onboard PCI audio chipset

Game Port Function	[Enable (200h-21
OnBoard Legacy Audio Support	[Enabled]
Sound Blaster Emulation	[Enabled]
Sound Blaster I/O Base Address	[220h-22Fh]
Sound Blaster IRQ	[IRQ5]
Sound Blaster DMA	[DMA 1]
MPU 401	[Enabled]
MPU 401 I/O Base Address	[330h-333h]
FM Enable (388h-38Bh)	[Enabled]

Game Port Function [Disabled]

Enable this field to use the game port. Configuration options: [Disabled]
[Enable (200h-207h)]

Onboard Legacy Audio Support [Disabled]

The onboard chipset is integrated with a SoundBlaster Pro controller. To use it, you must enable this field. Leave on the default setting [Disabled] if you want to use an add-on audio device. **NOTE:** To display the rest of the setup items, this field must be enabled (as shown above).

Sound Blaster Emulation [Disabled]

Select [Enabled] for this field if you want to use the Sound Blaster™ emulation feature.

Sound Blaster I/O Base Address [220h-22Fh]

Sound Blaster IRQ [IRQ5]

Sound Blaster DMA [DMA 1]

These fields set the I/O address, IRQ, and DMA channel for the Sound Blaster™ feature.

MPU 401 [Enabled]

Enable this field if you want to use the MIDI device onboard.

MPU 401 I/O Base Address [300h-303h]

This sets the I/O address for the onboard MIDI device.

FM Enable (388h-38Bh) [Disabled]

This field enables or disables the FM modulation feature.

4. BIOS SETUP

4.4.3 PCI Configuration

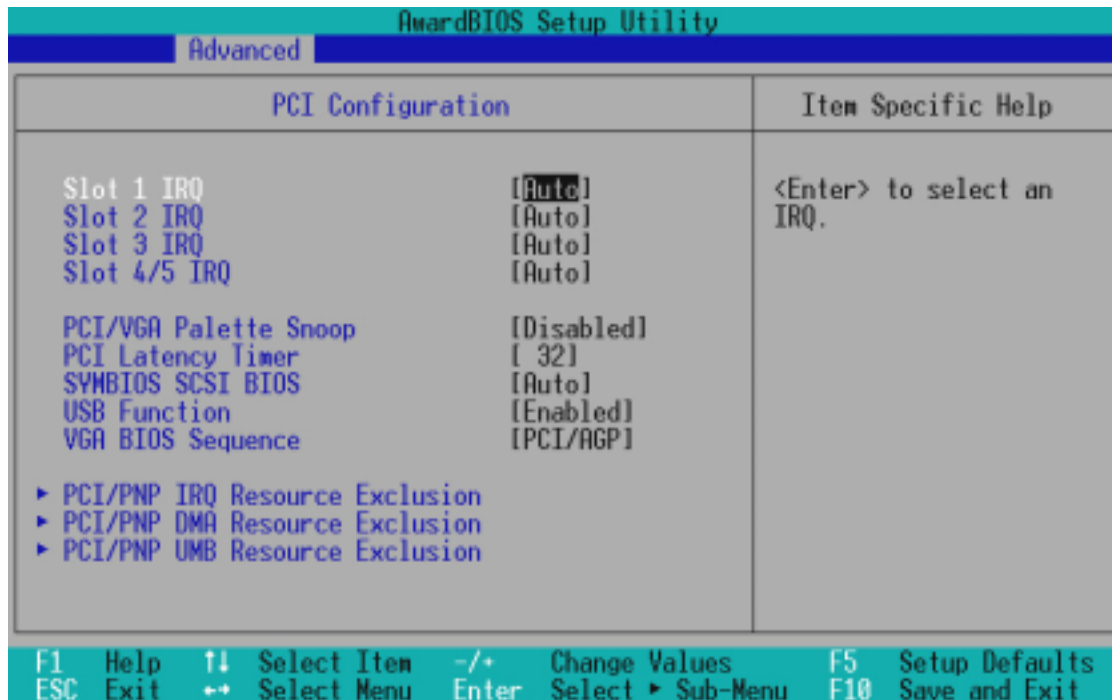

Slot 1, Slot 2, Slot 3, Slot 4/5 IRQ [Auto]

These fields set how IRQ use is determined for each PCI slot. The default setting for each field is [Auto], which utilizes auto-routing to determine IRQ use. Configuration options: [Auto] [NA] [3] [4] [5] [7] [9] [10] [11] [12] [14] [15]

PCI/VGA Palette Snoop [Disabled]

Some nonstandard VGA cards, such as graphics accelerators or MPEG video cards, may not show colors properly. The setting [Enabled] should correct this problem. Otherwise, leave this on the default setting of [Disabled]. Configuration options: [Disabled] [Enabled]

PCI Latency Timer [32]

Leave on default setting for best performance vs. stability.

SYMBIOS SCSI BIOS [Auto]

[Auto] allows the motherboard's BIOS to detect whether you have a Symbios SCSI card. If the Symbios SCSI card is detected, the motherboard's Symbios BIOS will be enabled; if no Symbios SCSI card is detected, the onboard Symbios SCSI BIOS will be disabled.

[Disabled] will disable the motherboard's Symbios SCSI BIOS so that the BIOS on an add-on Symbios SCSI card can be used. If your Symbios SCSI card does not have a BIOS, the Symbios SCSI card will not function. Configuration options: [Auto] [Disabled]

4. BIOS SETUP

USB Function [Enabled]

This motherboard supports Universal Serial Bus (USB) devices. Set to [Enabled] if you want to use USB devices. Configuration options: [Disabled] [Enabled]

VGA BIOS Sequence [PCI/AGP]

If your computer has both PCI and AGP VGA cards, this field allows you to select which of the cards will act as your primary graphics card. [AGP/PCI] uses the AGP card as your primary card. The default, [PCI/AGP], allows your PCI graphics card to take precedence when detected. Configuration options: [PCI/AGP] [AGP/PCI]

PCI/PNP IRQ Resource Exclusion

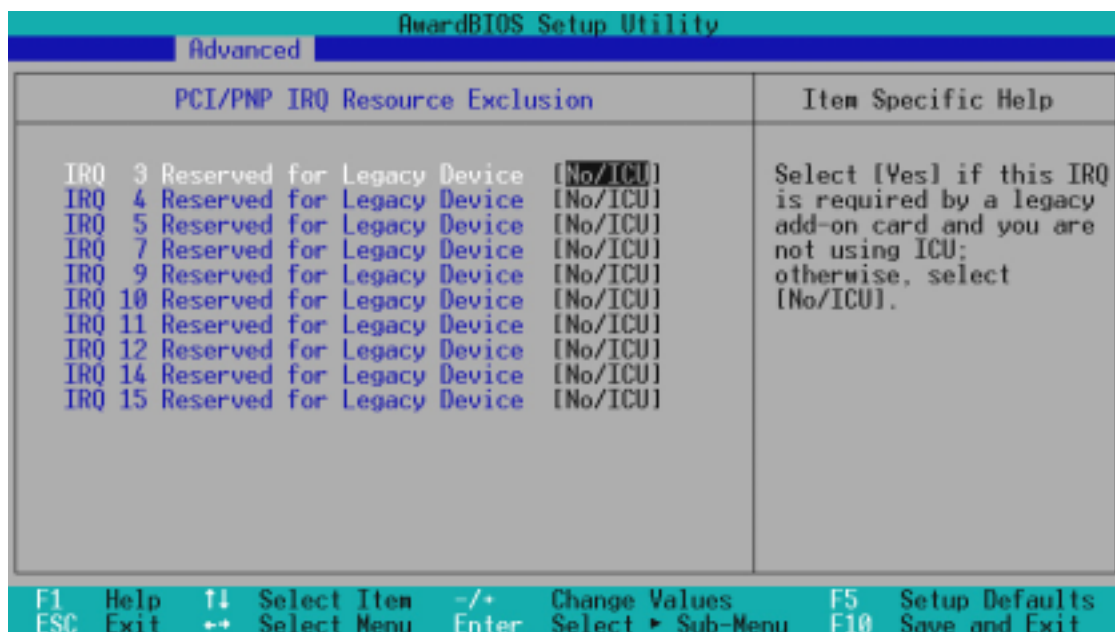

4. BIOS SETUP
PCI Configuration

IRQ XX Used for Legacy Device [No/ICU]

These fields indicate whether or not the displayed IRQ for each field is being used by an onboard legacy (non-PnP) ISA device. The default value indicates either that the displayed IRQ is not used or that ISA Configuration Utility (ICU) is being used to determine if an ISA device is using that IRQ. Configuration options: [No/ICU] [Yes]

4. BIOS SETUP

PCI/PNP DMA Resource Exclusion

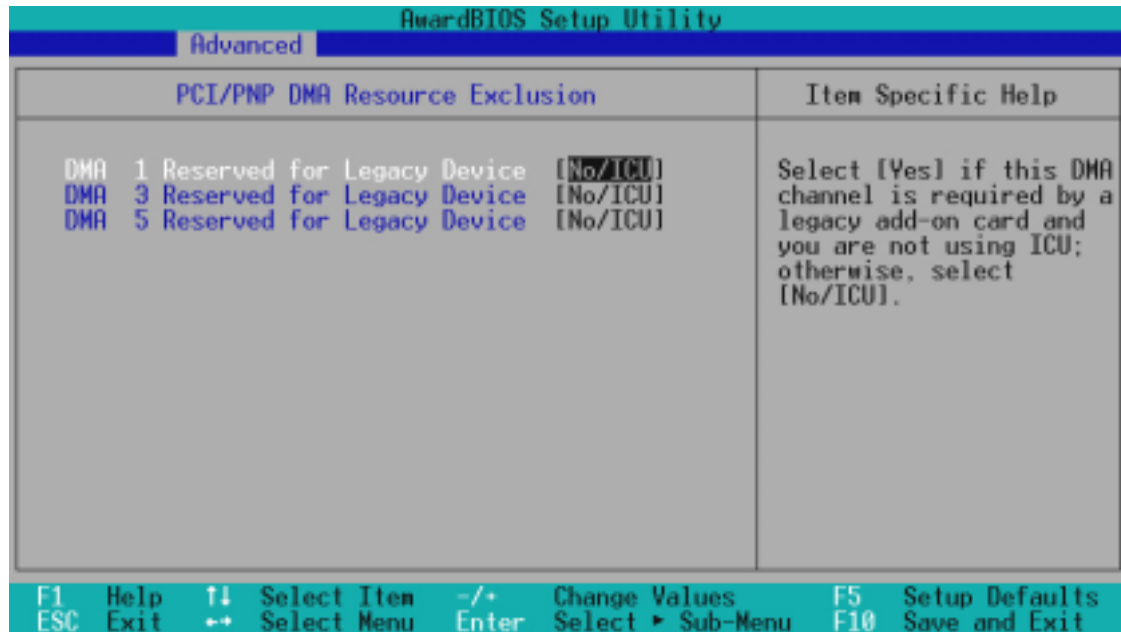

DMA x Used for Legacy Device [No/ICU]

These fields indicate whether or not the displayed DMA channel for each field is being used by an onboard legacy (non-PnP) ISA device. The default setting indicates either that the displayed DMA channel is not used or an ICU is being used to determine if an ISA device is using that channel. Configuration options: [No/ICU] [Yes]

PCI/PNP UMB Resource Exclusion

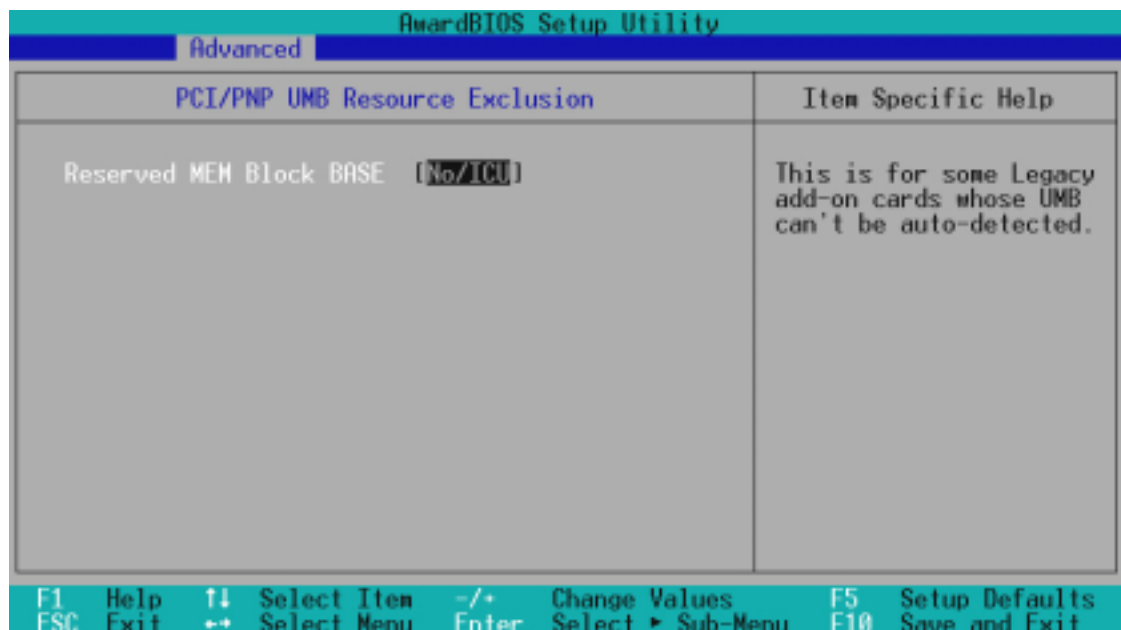

4. BIOS SETUP

Reserved MEM Block BASE [No/ICU]

This field allows you to set the base address and block size of an onboard legacy ISA device that uses any memory segment within the C800 and DFFF address range. If you have such a device and you are not using an ICU to specify its address range, select a base address from the six available options; the **Reserved MEM Block SIZE** field will then appear for selecting the block size. If you have more than one legacy ISA device onboard that requires the use of this address range, you can increase the block size to 8K, 16K, 32K, or 64K. If you are using an ICU to accomplish this task, leave **Reserved MEM Block BASE** to its default setting of [No/ICU]. Configuration options: [No/ICU] [C800] [CC00] [D000] [D400] [D800] [DC00]

4.4.4 Shadow Configuration

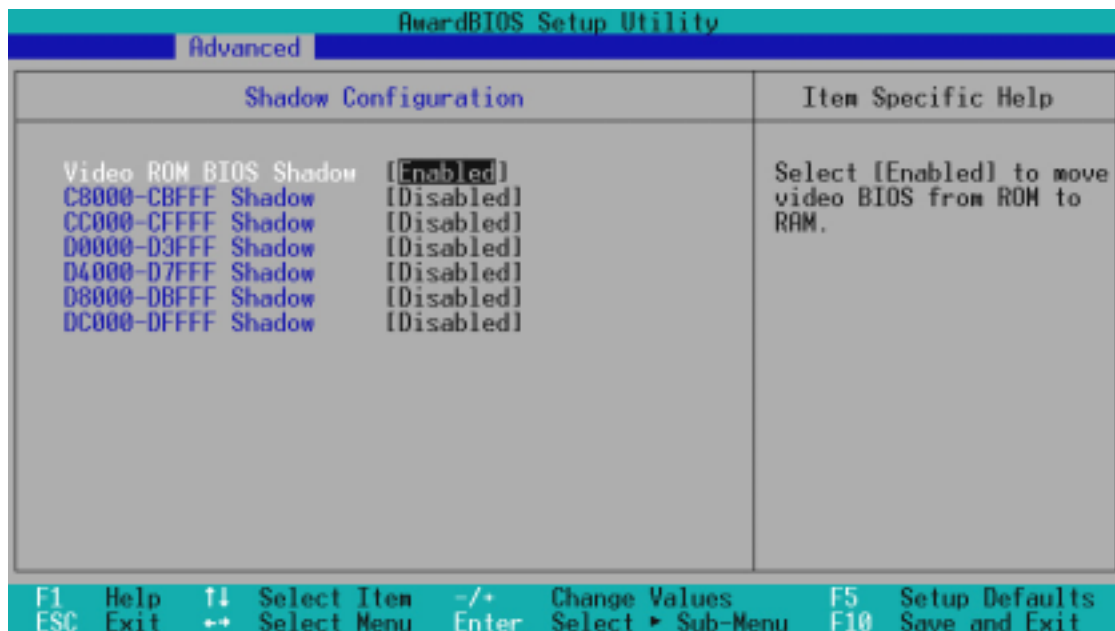

Video ROM BIOS Shadow [Enabled]

This field allows you to change the video BIOS location from ROM to RAM. Relocating to RAM enhances system performance, as information access is faster than the ROM. Configuration options: [Disabled] [Enabled]

C8000-DFFFF Shadow [Disabled]

These fields are used for shadowing other expansion card ROMs. If you install other expansion cards with ROMs on them, you will need to know which addresses the ROMs use to shadow them specifically. Shadowing a ROM reduces the memory available between 640K and 1024K by the amount used for this purpose. Configuration options: [Disabled] [Enabled]

4. BIOS SETUP

4.5 Power Menu

The Power menu allows you to reduce power consumption. This feature turns off the video display and shuts down the hard disk after a period of inactivity.

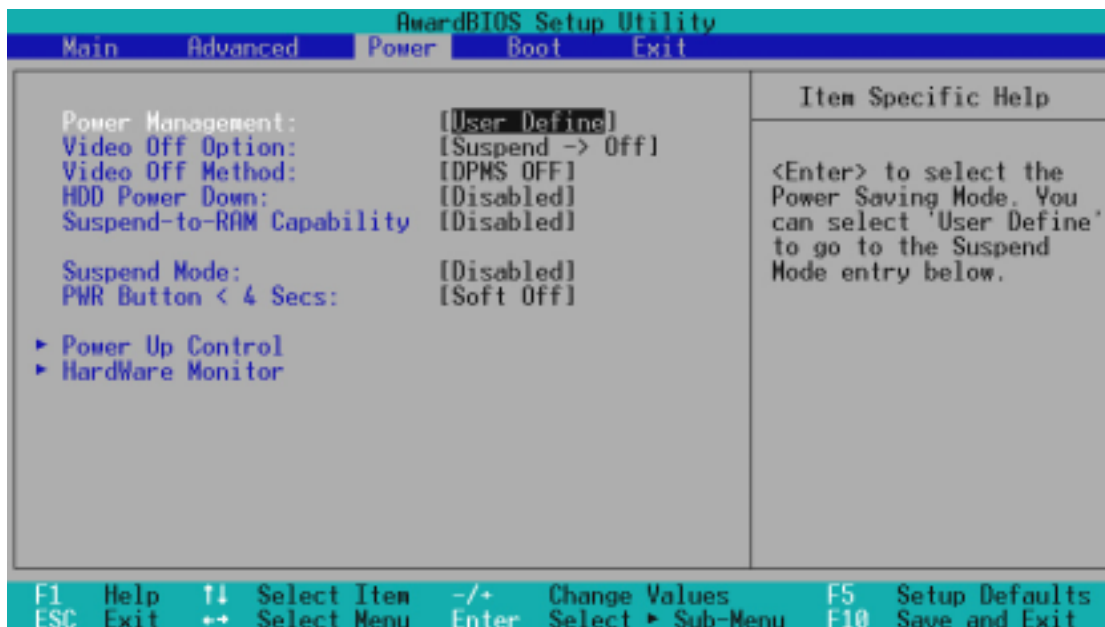

Power Management [User Define]

This option must be enabled to use any of the automatic power saving features. If this menu item is set to [Disabled], power management features will not function regardless of other field settings on this menu. The [User Define] option allows you to make your own selections in the Power menu. When set to [Max Saving], system power will be conserved to its greatest amount. The **Suspend Mode** field will then be set to predefined value that ensures maximum power savings.

This field acts as the master control for the power management modes. [Max Saving] puts the system into power saving mode after a brief period of system inactivity; [Min Saving] is almost the same as [Max Saving] except that the system inactivity period is longer; [Disabled] disables the power saving features; [User Define] allows you to set power saving options according to your preference. Configuration options: [User Define] [Disabled] [Min Saving] [Max Saving]

IMPORTANT: Advanced Power Management (APM) should be installed to keep the system time updated when the computer enters suspend mode activated by the BIOS Power Management. For DOS environments, you need to add the statement, DEVICE=C:\DOS\POWER.EXE, to your CONFIG.SYS file. For Windows 3.x and Windows 95, you need to install Windows with the APM feature. For Windows 98 and later, APM is automatically installed. A battery and power cord icon labeled “Power Management” will appear in the “Control Panel.” Choose “Advanced” in the Power Management Properties dialog box.

4. BIOS SETUP

Video Off Option [Suspend -> Off]

This field determines when to activate the video off feature for monitor power management. Configuration options: [Always On] [Suspend -> Off]

Video Off Method [DPMS OFF]

This field defines the video off features. The DPMS (Display Power Management System) feature allows the BIOS to control the video display card if it supports the DPMS feature. [Blank Screen] only blanks the screen (use this for monitors without power management or “green” features. If set up in your system, your screen saver will not display with [Blank Screen] selected). [V/H SYNC+Blank] blanks the screen and turns off vertical and horizontal scanning. Configuration options: [Blank Screen] [V/H SYNC+Blank] [DPMS Standby] [DPMS Suspend] [DPMS OFF] [DPMS Reduce ON]

HDD Power Down [Disabled]

Shuts down any IDE hard disk drives in the system after a period of inactivity as set in this user-configurable field. This feature does not affect SCSI hard drives. Configuration options: [Disabled] [1 Min] [2 Min] [3 Min]...[15 Min]

Suspend-to-RAM Capability [Disabled]

Suspend-to-RAM (STR) is an energy-saving feature. In Suspend-to-RAM state, all devices on the computer are turned off, except for the system RAM. Thus, the PC consumes less than 5 Watts of power. [Auto] allows the BIOS to provide STR support, but to make the STR feature function, your operating system, device drivers, and power supply all have to support this feature. Please make sure your power supply can supply at least 720mA on the +5VSB lead. If your OS, power supply, and the expansion cards you use on the motherboard do not support the STR function, you may leave this field on the default setting [Disabled]. Configuration options: [Auto] [Disabled]

Suspend Mode [Disabled]

Sets the time period before the system goes into suspend mode. Configuration options: [Disabled] [30 Sec] [1 Min]... [40 Min]

PWR Button < 4 Secs [Soft Off]

When set to [Soft off], the ATX switch can be used as a normal system power-off button when pressed for less than 4 seconds. [Suspend] allows the button to have a dual function where pressing less than 4 seconds will place the system in sleep mode. Regardless of the setting, holding the ATX switch for more than 4 seconds will power off the system. Configuration options: [Soft off] [Suspend]

4. BIOS SETUP

4.5.1 Power Up Control

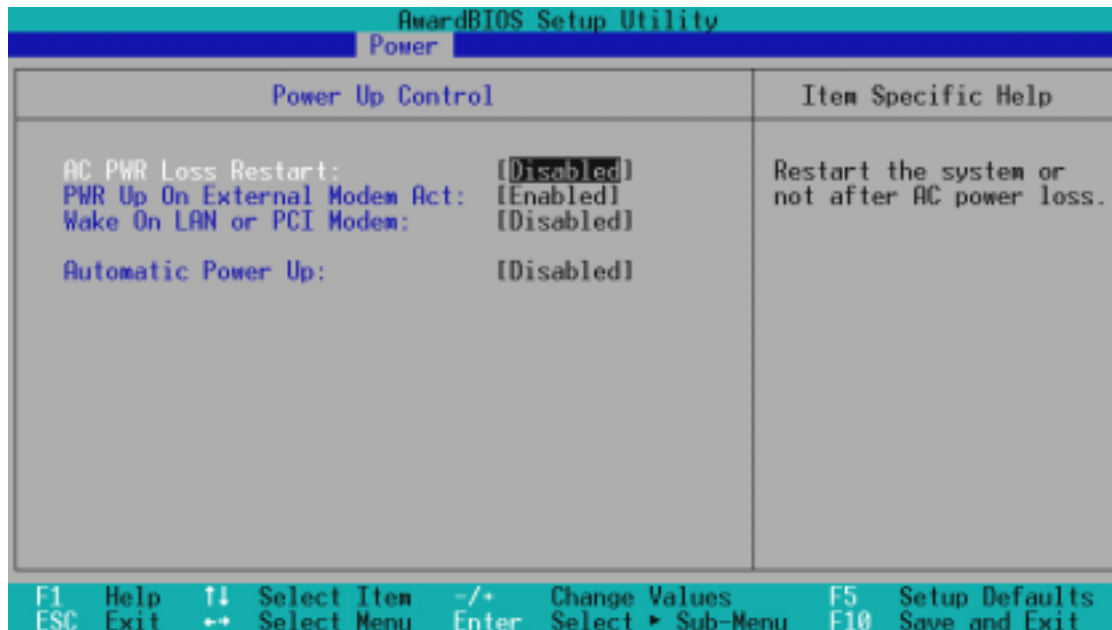

AC PWR Loss Restart [Disabled]

This allows you to set whether you want your system to reboot after the power has been interrupted. [Disabled] leaves your system off and [Enabled] reboots your system. [Previous State] sets your system back to the state it is before the power interruption. Configuration options: [Disabled] [Enabled] [Previous State]

PWR Up On External Modem Act [Enabled]

This allows either settings of [Enabled] or [Disabled] for powering up the computer when the modem receives a call while the computer is in Soft-off mode. **NOTE:** The computer cannot receive or transmit data until the computer and applications are fully running. Thus connection cannot be made on the first try. Turning an external modem off and then back on while the computer is off causes an initialization string that will also cause the system to power on. Configuration options: [Disabled] [Enabled]

Wake On LAN or PCI Modem [Disabled]

Wake-On-LAN/PCI Modem allows your computer to be booted from another computer via a network by sending a wake-up frame or signal. Configuration options: [Disabled] [Enabled]

IMPORTANT: This feature requires an optional network interface card with Wake-On-LAN and an ATX power supply with at least 720mA +5V standby power.

4. BIOS SETUP

Automatic Power Up [Disabled]

This allows an unattended or automatic system power up. You may configure your system to power up at a certain time of the day by selecting [Everyday] or at a certain time and day by selecting [By Date]. **NOTE:** *Automatic Power Up* will not work if the system is powered down by operating systems, such as Windows 98, that have ACPI support enabled. Configuration options: [Disabled] [Everyday] [By Date]

4. BIOS SETUP

4.5.2 Hardware Monitor

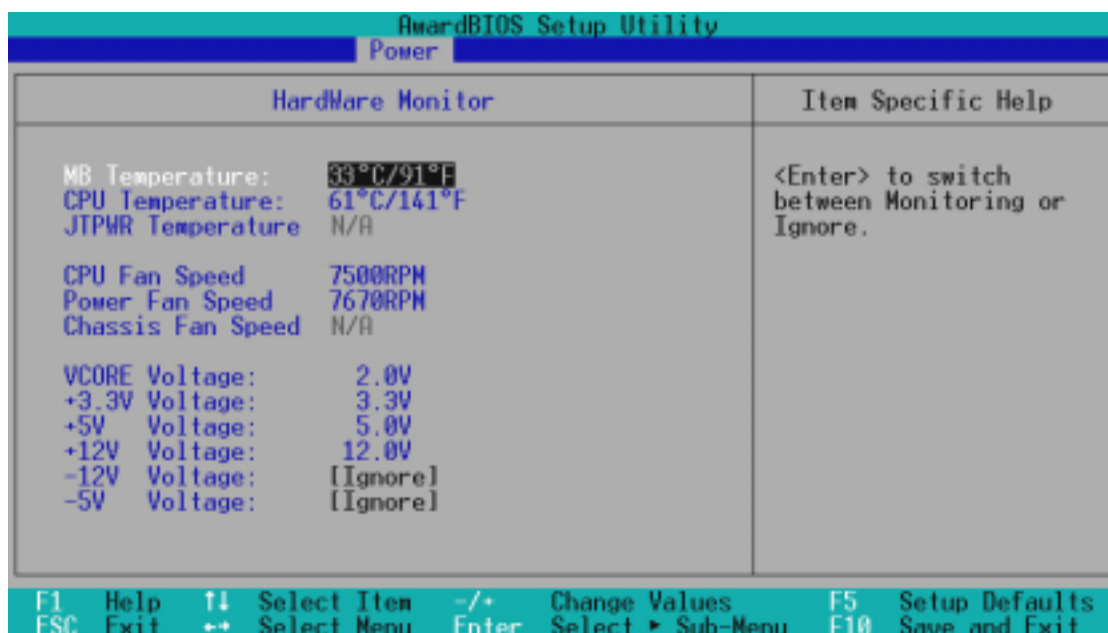

MB Temperature [xxx°C/xxx°F] **CPU Temperature [xxx°C/xxx°F]** **JTPWR Temperature [xxx°C/xxx°F]**

The onboard hardware monitor is able to detect the MB (motherboard), CPU and power supply temperatures. Set to [Ignore] only if necessary.

CPU Fan Speed [xxxxRPM] **Power Fan Speed [xxxxRPM]** **Chassis Fan Speed [xxxxRPM]**

The onboard hardware monitor is able to detect the CPU fan speed, power supply fan speed, and the chassis fan speed in rotations per minute (RPM). The presence of the fans is automatically detected. Set to [Ignore] only if necessary.

VCore Voltage, +3.3V Voltage, +5V Voltage, +12V Voltage [xx.xV] **-12V Voltage, -5V Voltage [Ignore]**

The onboard hardware monitor is able to detect the voltage output by the onboard voltage regulators. Set to [Ignore] only if necessary.

NOTE: If any of the monitored items is out of range, an error message will appear: “Hardware Monitor found an error. Enter Power setup menu for details”. You will then be prompted to “Press **F1** to continue, **DEL** to enter SETUP”.

4. BIOS SETUP

4.6 Boot Menu

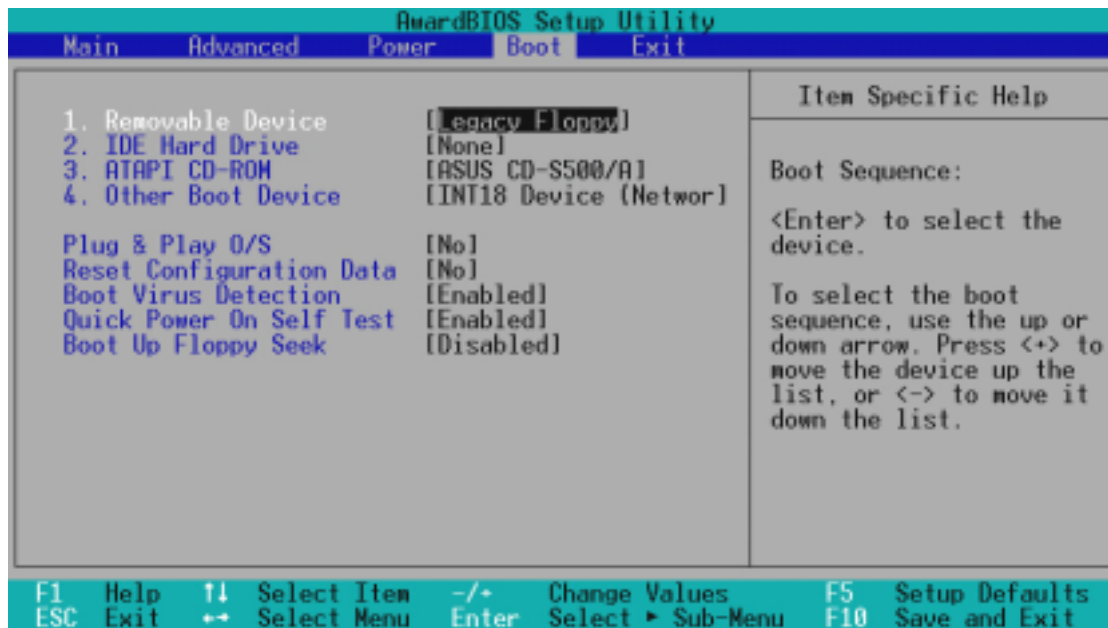

Boot Sequence

The Boot menu allows you to select among the four possible types of boot devices listed using the up and down arrow keys. By using the <+> or <Space> key, you can promote devices and by using the <-> key, you can demote devices. Promotion or demotion of devices alters the priority which the system uses to search for a boot device on system power up. Configuration fields include **Removable Devices**, **IDE Hard Drive**, **ATAPI CD-ROM**, and **Other Boot Device**.

Removable Device [Legacy Floppy]

Configuration options: [Disabled] [Legacy Floppy] [LS120] [ZIP-100] [ATAPI MO]

IDE Hard Drive

This field allows you to select which IDE hard disk drive to use in the boot sequence. Pressing [Enter] will show the product IDs of all connected IDE hard disk drives.

ATAPI CD-ROM

This field allows you to select which ATAPI CD-ROM drive to use in the boot sequence. Pressing [Enter] will show the product IDs of all your connected ATAPI CD-ROM drives.

Other Boot Device Select [INT18 Device (Network)]

Configuration options: [Disabled] [SCSI Boot Device] [INT18 Device (Network)] [LANDesk (R) Service Agent]

4. BIOS SETUP

Plug & Play O/S [No]

This field allows you to use a Plug-and-Play (PnP) operating system to configure the PCI bus slots instead of using the BIOS. When [Yes] is selected, interrupts may be reassigned by the OS. When a non-PnP OS is installed or you want to prevent reassigning of interrupt settings, select the default setting of [No]. Configuration options: [No] [Yes]

Reset Configuration Data [No]

The Extended System Configuration Data (ESCD) contain information about non-PnP devices. It can also hold the complete record of how the system was configured the last time it was booted. Select [Yes] only if you want to clear these data during the Power-On Self Test (POST). Configuration options: [No] [Yes]

Boot Virus Detection [Enabled]

This field allows you to set boot virus detection, ensuring a virus-free boot sector. The system halts and displays a warning message when it detects a virus. If this occurs, you can either allow the operation to continue or use a virus-free bootable floppy disk to restart and investigate your system. Configuration options: [Disabled] [Enabled]

Quick Power On Self Test [Enabled]

This field speeds up the Power-On-Self Test (POST) routine by skipping retesting a second, third, and fourth time. Configuration options: [Disabled] [Enabled]

Boot Up Floppy Seek [Disabled]

When enabled, the BIOS will seek the floppy disk drive to determine whether the drive has 40 or 80 tracks. Configuration options: [Disabled] [Enabled]

4. BIOS SETUP

4.7 Exit Menu

Once you have made all of your selections from the various menus in the Setup program, you should save your changes and exit Setup. Select **Exit** from the menu bar to display the following menu:

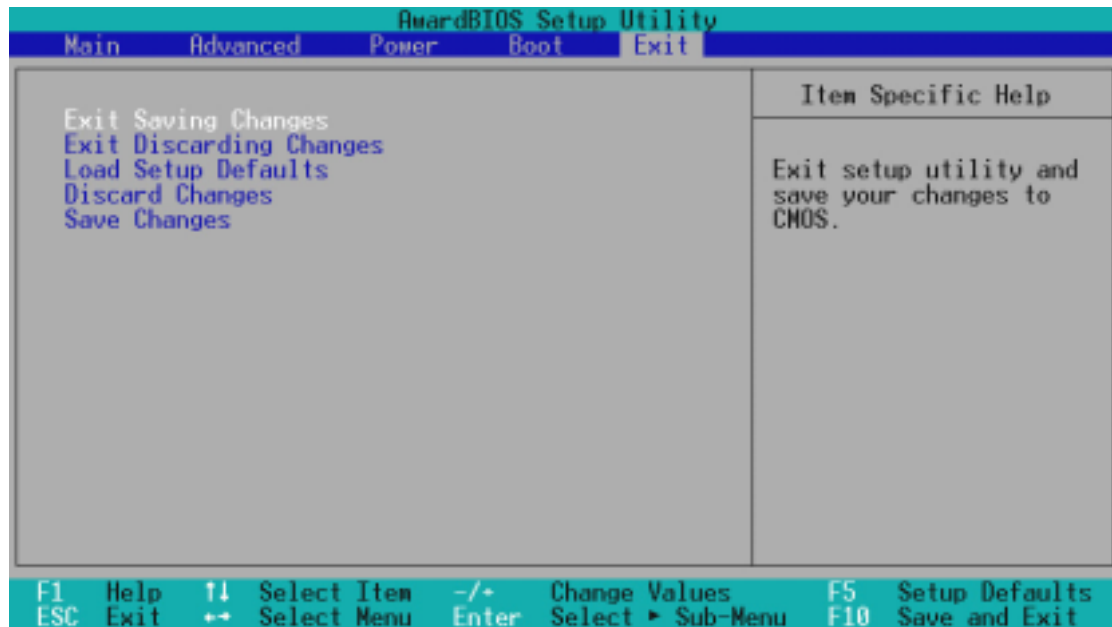

NOTE: Pressing <Esc> does not exit this menu. You must select one of the options from this menu or <F10> from the legend bar to exit this menu.

Exit Saving Changes

Once you are finished making your selections, choose this option from the Exit menu to ensure the values you selected are saved to the CMOS RAM. The CMOS RAM is sustained by an onboard backup battery and stays on even when the PC is turned off. Once this option is selected, a confirmation is asked. Select [Yes] to save changes and exit.

NOTE: If you attempt to exit the Setup program without saving your changes, the program will prompt you with a message asking if you want to save your changes before exiting. Pressing <Enter> will then save changes while exiting.

Exit Discarding Changes

This option should only be used if you do not want to save the changes you have made to the Setup program. If you have made changes to fields other than system date, system time, and password, the system will ask for confirmation before exiting.

4. BIOS SETUP

Load Setup Defaults

This option allows you to load the default values for each of the parameters on the Setup menus. When this option is selected or if <F5> is pressed, a confirmation is requested. Select [Yes] to load default values. You can now select **Exit Saving Changes** or make other changes before saving the values to the non-volatile RAM.

Discard Changes

This option allows you to discard the selections you made and restore the values you previously saved. After selecting this option, a confirmation is requested. Select [Yes] to discard any changes and load the previously saved values.

Save Changes

This option saves your selections without exiting the Setup program. You can then return to other menus and make changes. After selecting this option, all selections are saved and a confirmation is requested. Select [Yes] to save any changes to the non-volatile RAM.

5. SOFTWARE SETUP

5.1 Operating Systems

You should always use the latest operating system and updates when using new hardware to ensure full compliancy. You may use any version of Windows 98, but for Windows 95, you must use OSR 2.0 or later. For Windows NT 4.0, you must use Service Pack 3.0 or later.

5.1.1 Windows 98 First Time Installation

When you start Windows for the first time after the installation of your motherboard, Windows 98 will detect the onboard audio and video chips and may attempt to install a driver from its system registry. When prompted to restart, select **No** and then follow the normal setup procedures later in this section.

NOTE: The screen displays in this and the following section may not reflect exactly the screen contents displayed on your screen.

5. SOFTWARE SETUP

5.2 K7V Series Motherboard Support CD

NOTE: The support CD contents are subject to change at any time without notice.

To begin using your support CD disc, just insert it into your CD-ROM drive and the support CD installation menu should appear. If the menu does not appear, double-click or run **D:\ASSETUP.EXE** (assuming that your CD-ROM drive is drive **D:**).

5.2.1 Installation Menu



- **Show MB Information:** Allows you to view information about your motherboard, such as product name, BIOS version, and CPU.
- **Browse CD Content:** Allows you to view the contents of the CD.
- **Registry patch for VIA Chipset:** Installs VIA Chipset Functions Registry patch.
- **VIA PCI IRQ Routing Miniport Driver:** Installs VIA IRQ Routing Miniport Driver.
- **AUDIO Driver (Optional):** Installs the necessary audio drivers for the onboard audio CODEC.
- **PC-Cillin 98:** Installs the PC-cillin virus protection software. View the online help for more information.
- **Acrobat Reader Vx.x:** Installs the Adobe Acrobat Reader software necessary to view user's manuals saved in PDF format. Updated or other language versions of this motherboard's manual is available in PDF format at any of our web sites.
- **IDE Driver:** Installs VIA Bus Master PCI IDE Driver.
- **AGP Miniport Driver:** Installs the necessary AGP miniport driver under Windows 9x.
- **ASUS PC Probe x:** Installs a smart utility to monitor your computer's fan, temperature, and voltages.
- **YAMAHA XGStudio (Optional):** Installs the Yamaha XGplayer for playing MIDI files, audio files, movie files and audio CDs. See online help for more information.
- **EXIT:** Exits the CD installation menu.

Additional CD Content: Flash BIOS writer in the **FLASH** folder.

5. SOFTWARE SETUP

5.3 Registry patch for VIA Chipset

Insert the Support CD that came with your motherboard into your CD-ROM drive or double-click the CD drive icon in **My Computer** to bring up the setup screen.

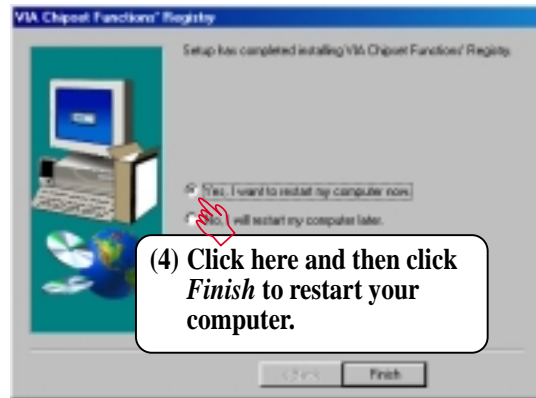
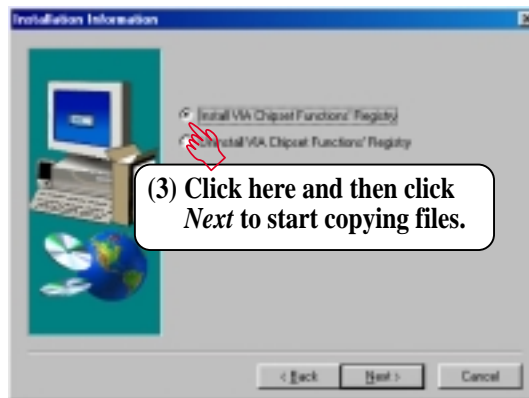
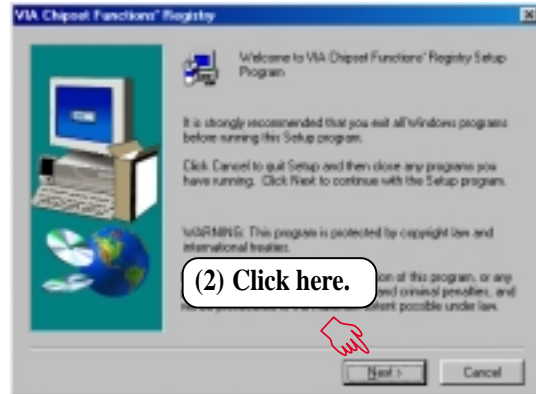

NOTE: You may choose to restart your computer later when this option is offered, especially if you still want to install other drivers and/or software. You may not, however, be able to use immediately the devices associated with the drivers or software because these drivers need to be enabled. These drivers are enabled when Windows starts/restarts.

5. SOFTWARE SETUP

5.4 VIA PCI IRQ Routing Miniport Driver

Insert the Support CD that came with your motherboard into your CD-ROM drive or double-click the CD drive icon in **My Computer** to bring up the setup screen.

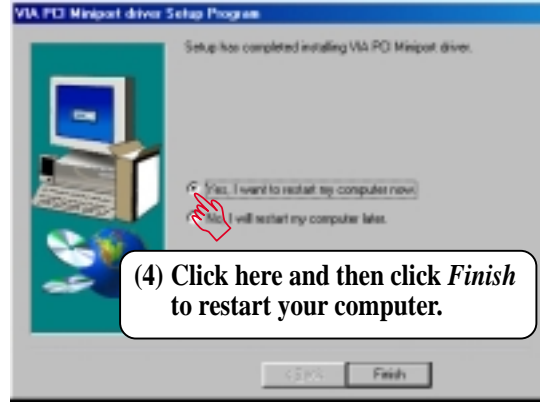
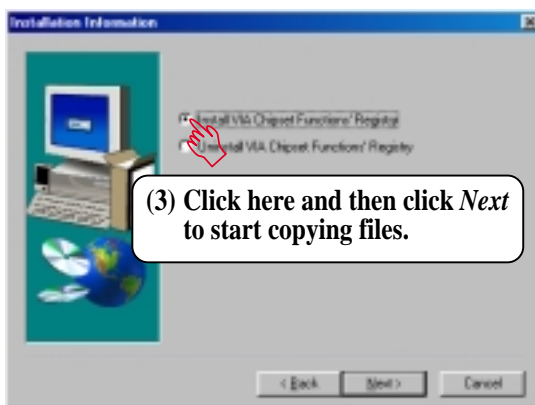
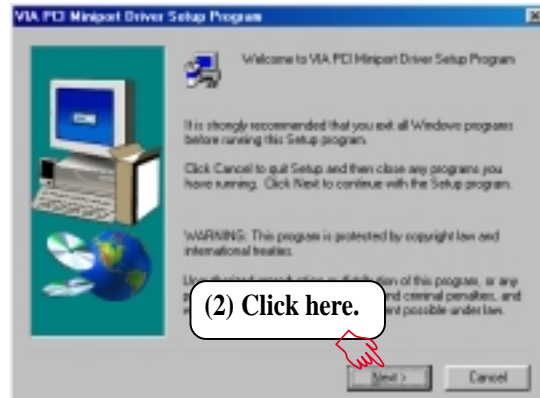

NOTE: You may choose to restart your computer later when this option is offered, especially if you still want to install other drivers and/or software. You may not, however, be able to use immediately the devices associated with the drivers or software because these drivers need to be enabled. These drivers are enabled when Windows starts/restarts.

5. SOFTWARE SETUP

5.5 AUDIO Driver (only with onboard audio option)

Insert the Support CD that came with your motherboard into your CD-ROM drive or double-click the CD drive icon in **My Computer** to bring up the setup screen.

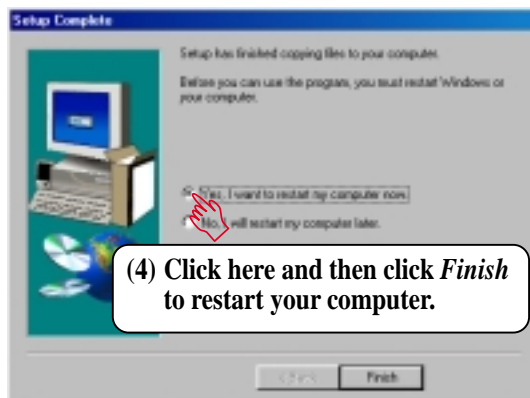
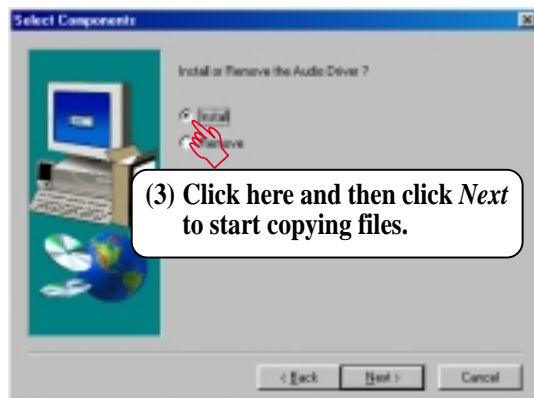
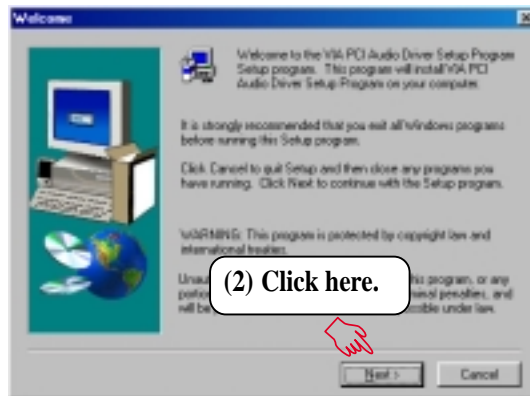

NOTE: You may choose to restart your computer later when this option is offered, especially if you still want to install other drivers and/or software. You may not, however, be able to use immediately the devices associated with the drivers or software because these drivers need to be enabled. These drivers are enabled when Windows starts/restarts.

5. SOFTWARE SETUP

5.6 PC-cillin 98

Insert the Support CD that came with your motherboard into your CD-ROM drive or double-click the CD drive icon in **My Computer** to bring up the setup screen.

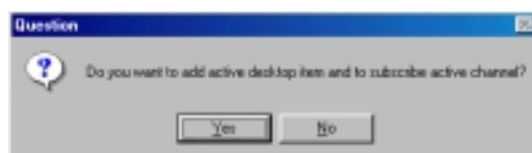
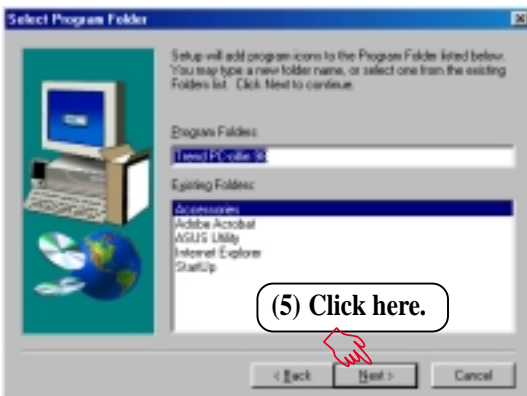
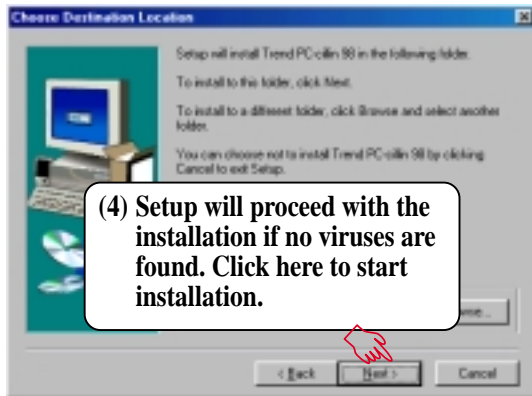
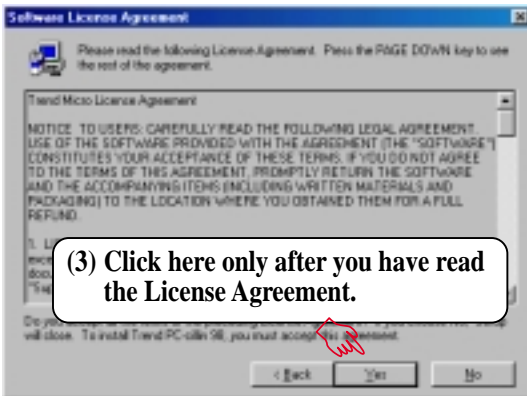

(6) & (7) Select the preferred features by clicking the appropriate buttons.

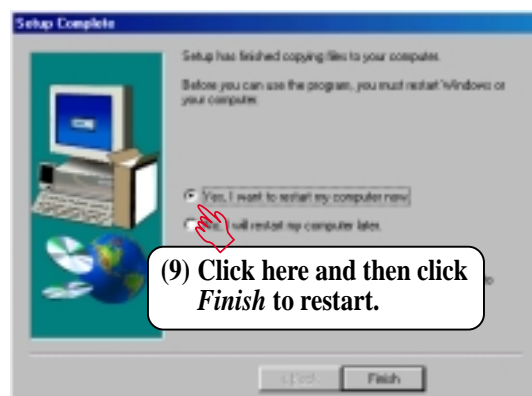
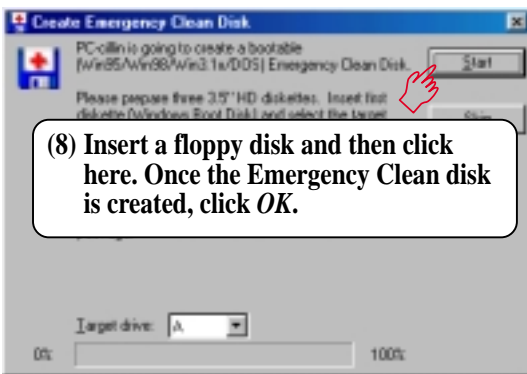
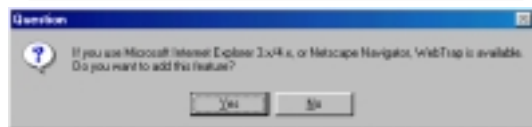

5. SOFTWARE SETUP

5.7 Acrobat Reader Vx.x

Insert the Support CD that came with your motherboard into your CD-ROM drive or double-click the CD drive icon in **My Computer** to bring up the setup screen.

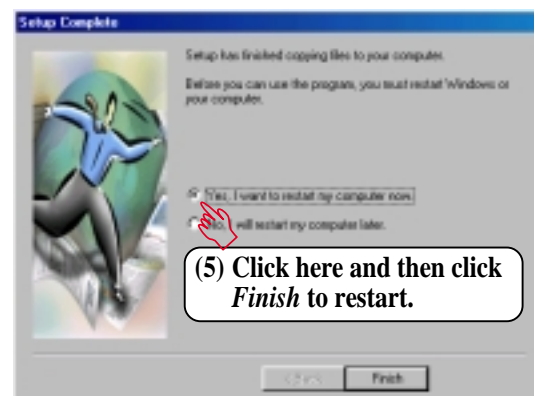
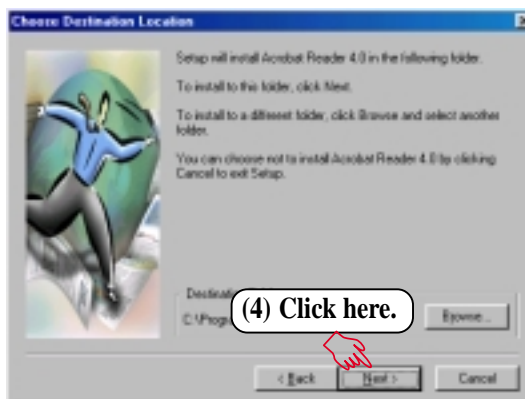
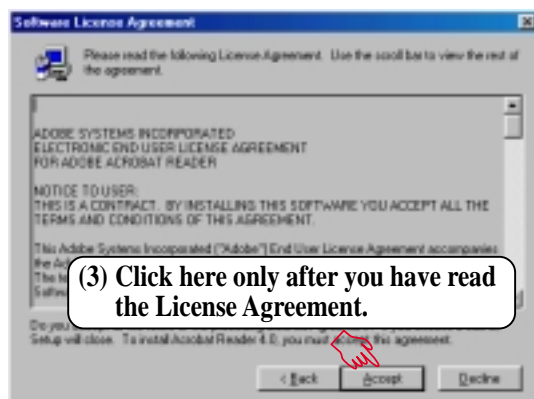
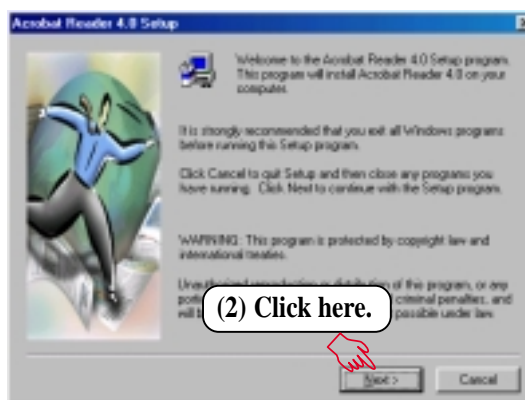

5. SOFTWARE SETUP

5.8 IDE Driver

Insert the Support CD that came with your motherboard into your CD-ROM drive or double-click the CD drive icon in **My Computer** to bring up the setup screen.

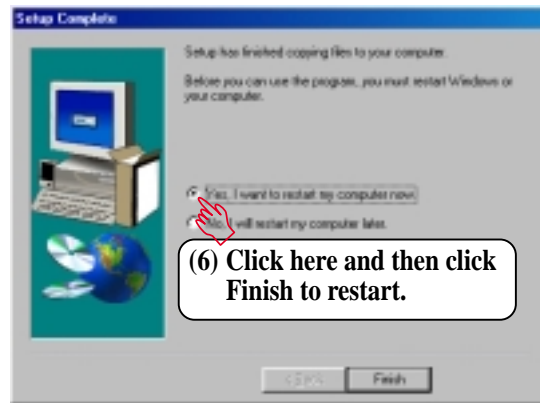
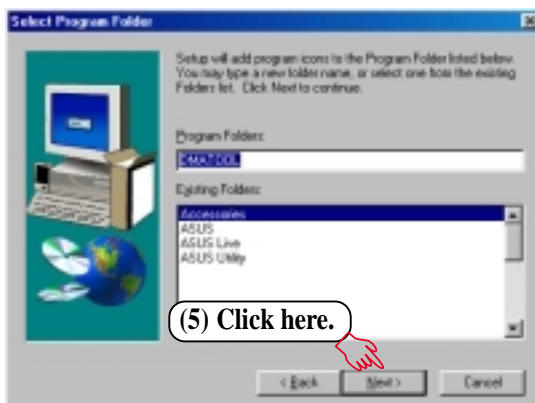
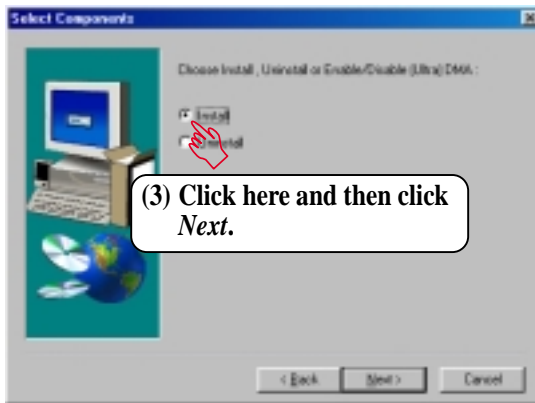

5. SOFTWARE SETUP

5.9 AGP Miniport Driver

Insert the Support CD that came with your motherboard into your CD-ROM drive or double-click the CD drive icon in **My Computer** to bring up the setup screen.

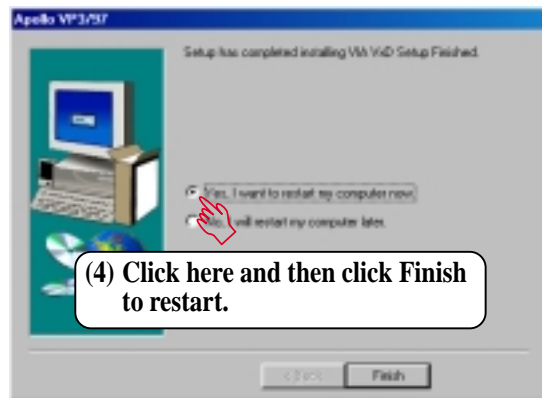
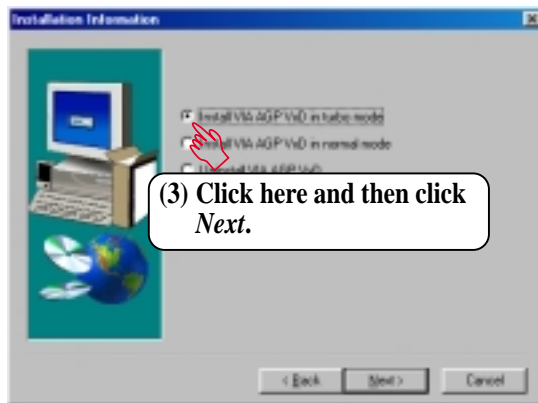

5. SOFTWARE SETUP

5.11 YAMAHA XGStudio (only with onboard audio option)

Insert the Support CD that came with your motherboard into your CD-ROM drive or double-click the CD drive icon in **My Computer** to bring up the setup screen.

NOTE: Make sure that you have uninstalled any old version of the YAMAHA SoftSynthesizer/XGplayer before installing this version. If you can't uninstall your old version using the procedures in **5.12 Uninstalling Programs**, see the README.TXT files under the Yamaha folder of your support CD for uninstallation information.

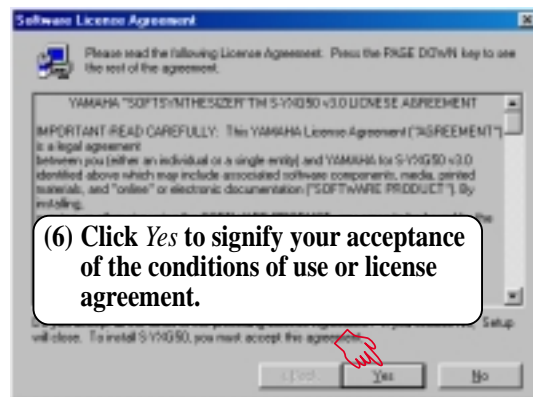
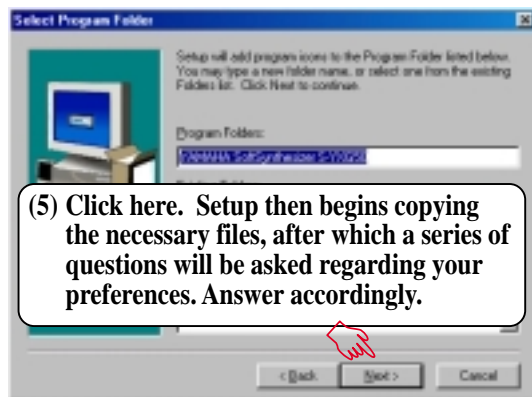
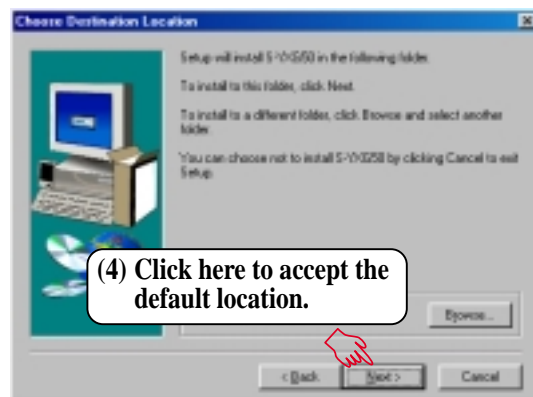
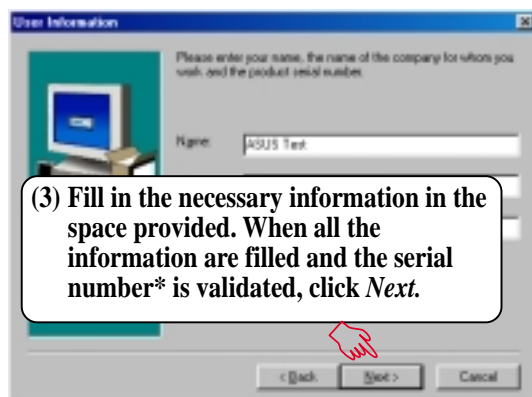
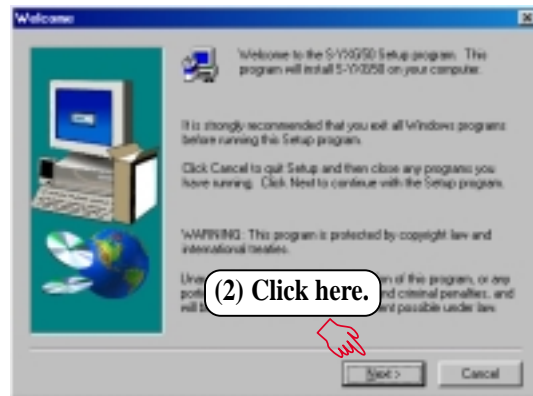

*The product serial number can be found on this software's license agreement card.

5. SOFTWARE SETUP

5.12 Uninstalling Programs

Add/Remove Programs is a basic component within Windows. You may use this function if a program does not provide its own uninstallation program.

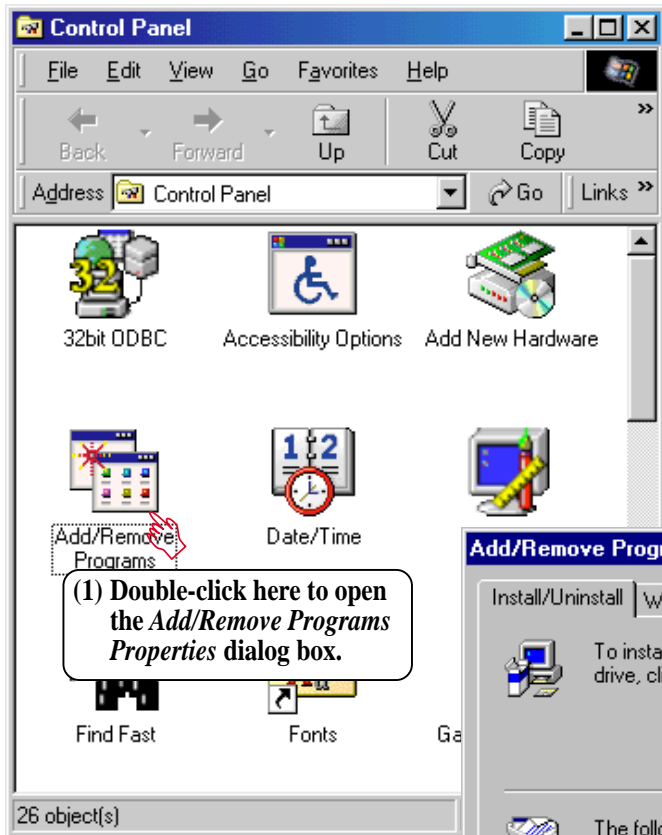

(1) Double-click here to open the Add/Remove Programs Properties dialog box.

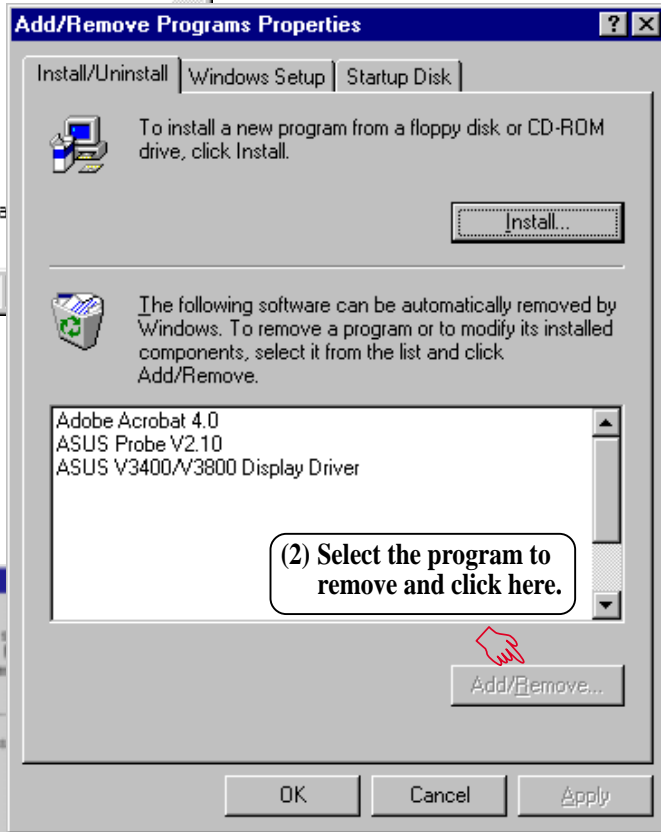

(2) Select the program to remove and click here.

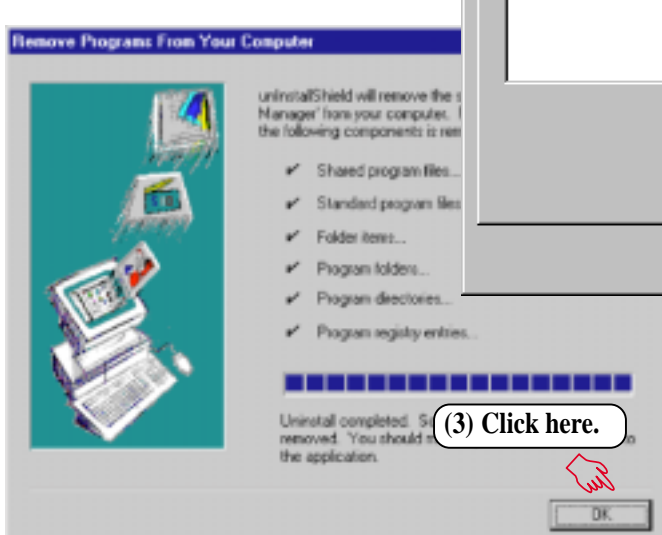

(3) Click here.

6. SOFTWARE REFERENCE

6.1 ASUS PC Probe

ASUS PC Probe is a convenient utility to continuously monitor your computer system's vital components, such as fan rotations, voltages, and temperatures. It also has a utility that lets you review useful information about your computer, such as hard disk space, memory usage, and CPU type, CPU speed, and internal/external frequencies through the DMI Explorer.

6.1.1 Starting ASUS PC Probe

When ASUS PC Probe starts, a splash screen appears allowing you to select whether to show the screen again when you open PC Probe or not. To bypass this startup screen, clear the **Show up in next execution** check box.

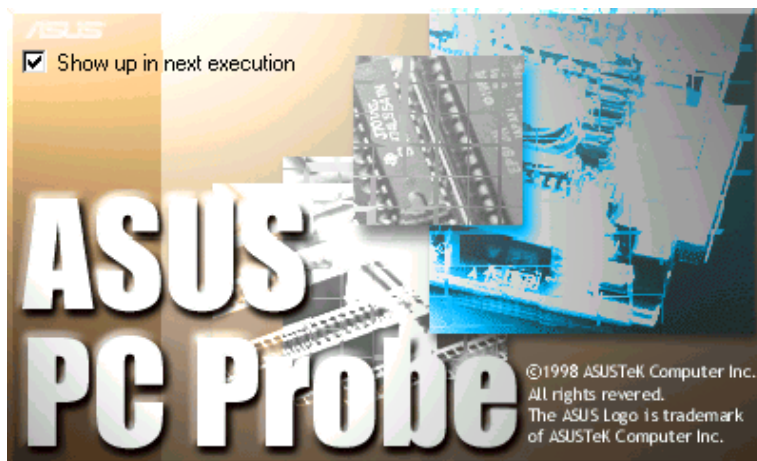

To open **ASUS PC Probe**, click the Windows **Start** button, point to **Programs**, and then **ASUS Utility**, and then click **Probe Vx.xx**.

The PC Probe icon  will appear on the taskbar's system tray indicating that ASUS PC Probe is running. Clicking the icon will allow you to see the status of your PC.



6. SOFTWARE REFERENCE

6.1.2 Using ASUS PC Probe

Monitoring

Monitor Summary

Shows a summary of the items being monitored.



Temperature Monitor

Shows the PC's temperature (for supported processors only).

Temperature Warning threshold adjustment
(Move the slider up to increase the threshold level or down to decrease the threshold level)



Fan Monitor

Shows the PC's fan rotation.

Fan Warning threshold adjustment
(Move the slider up to increase the threshold level or down to decrease the threshold level)



Voltage Monitor

Shows the PC's voltages.



6. SOFTWARE REFERENCE

Settings

Lets you set threshold levels and polling intervals or refresh times of the PC's temperature, fan rotation, and voltages.



CPU Cooling System Setup

Lets you select when to enable software CPU cooling. When **When CPU Overheated** is selected, the CPU cooling system is enabled whenever the CPU temperature reaches the threshold value.

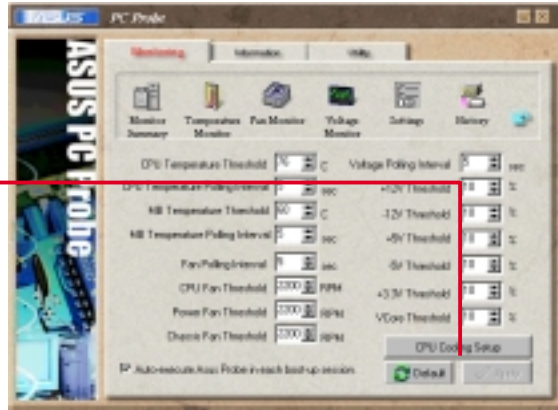

6. SW REFERENCE
ASUS PC Probe

History

Lets you record the monitoring activity of a certain component of your PC for future reference.

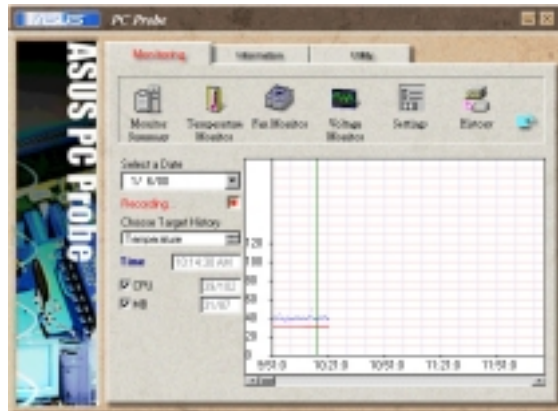

Fan Control

Lets you enable/disable Smart Fan Control. Smart Fan Control adjusts the fan speed automatically based on the current CPU temperature and predefined threshold.



Information

Hard Drives

Shows the used and free space of the PC's hard disk drives and the file allocation table or file system used.



6. SOFTWARE REFERENCE

Memory

Shows the PC's memory load, memory usage, and paging file usage.



Device Summary

Shows a summary of devices in your PC.



DMI Explorer

Shows information pertinent to the PC, such as CPU type, CPU speed, and internal/external frequencies, and memory size.



Utility

Lets you run programs outside of the ASUS Probe modules. To run a program, click **Execute Program**. **NOTE:** This feature is currently unavailable.



6. SOFTWARE REFERENCE

6.1.3 ASUS PC Probe Task Bar Icon

Right clicking the PC Probe icon will bring up a menu to open or exit ASUS PC Probe and pause or resume all system monitoring.



When the ASUS PC Probe senses a problem with your PC, portions of the ASUS PC Probe icon changes to red, the PC speaker beeps, and the ASUS PC Probe monitor is displayed.

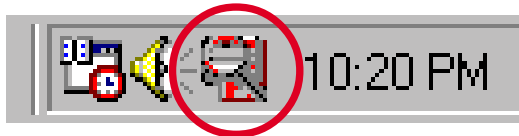

6. SOFTWARE REFERENCE

6.2 YAMAHA XGStudio



The XGplayer that is installed when you choose this option is an application that is used to playback multimedia files. The XGplayer allows playback of MIDI files (.mid, .rmi), audio files (.wav, .mp3), movie files (.avi, .mpg) and audio CDs all from a single application. With MIDI files, you can mix, arrange (change voices/effects) and attach MIDI files to e-mails. Also, its links to various Internet services allows you to listen to music on web sites or purchase music easily.

6.3.1 Using YAMAHA XGplayer

To set up the S-YXG50 SoftSynthesizer to match your system's performance (for example, playback sound, quality priority/CPU load reduction priority), click **Start**, point to **Programs**, point to **YAMAHA SoftSynthesizer S-YXG50**, and then click **S-YXG50 Setup**. You may also right-click the YAMAHA SXG Driver icon  on the taskbar and then click **SoftSynthesizer Setup**.

To get help on the SoftSynthesizer settings, click **Start**, point to **Programs**, point to **YAMAHA SoftSynthesizer S-YXG50**, and then click **S-YXG50 Help**.

To start the YAMAHA XGplayer, click **Start**, point to **Programs**, point to **YAMAHA SoftSynthesizer S-YXG50**, and then click **XGplayer**. You may also right-click the YAMAHA SXG Driver icon  on the taskbar and then click **XGplayer**.

For details on the YAMAHA XGplayer, click the Help icon  on the Main Panel. You may also right-click the YAMAHA SXG Driver icon  on the taskbar and then click **SoftSynthesizer Help**.

6.3.2 YAMAHA XGplayer Main Panel

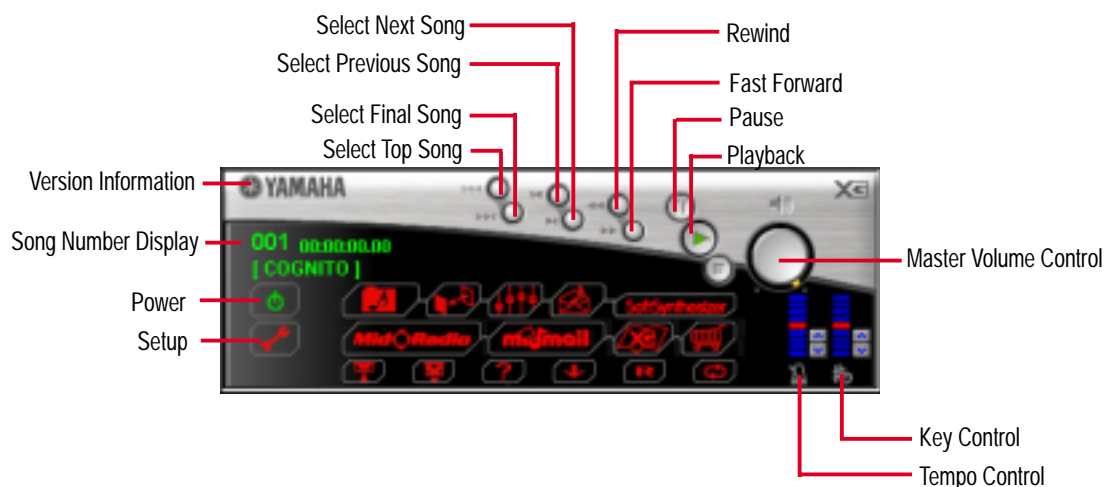

6. SOFTWARE REFERENCE

6.3.3 YAMAHA XGplayer Mixer Panel

To open the Mixer Panel, click the Open Mixer icon  on the Main Panel.

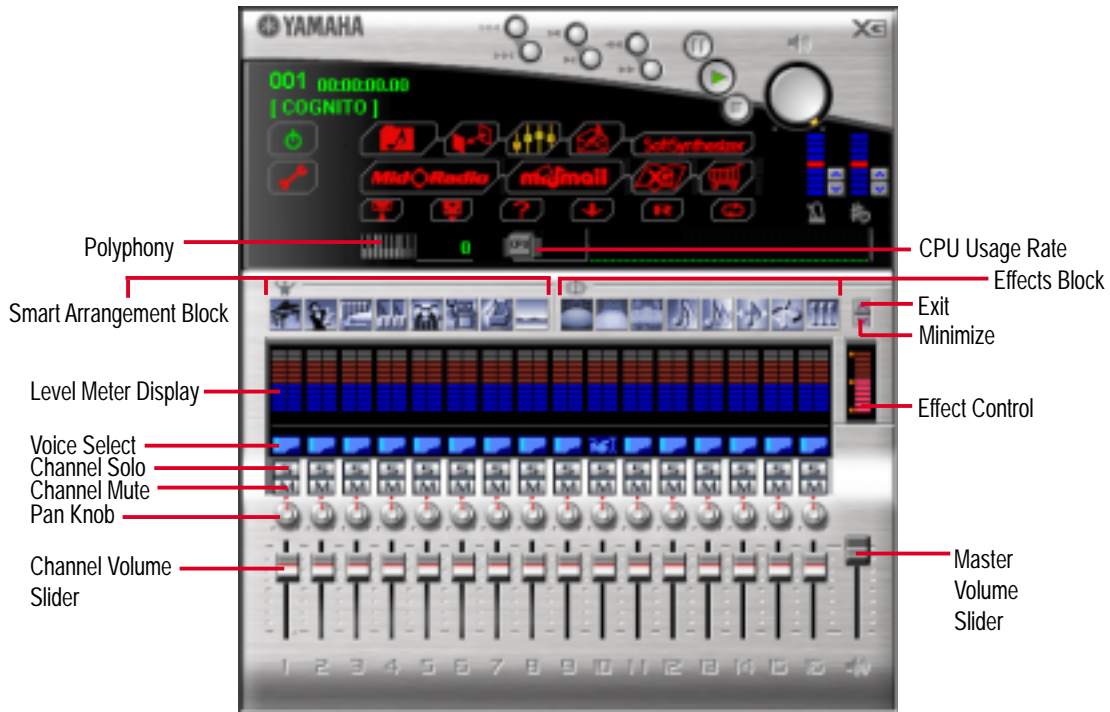

6.3.4 YAMAHA XGplayer Minimize Panel

To open the Minimize Panel, click the Minimize icon  on the Main Panel.

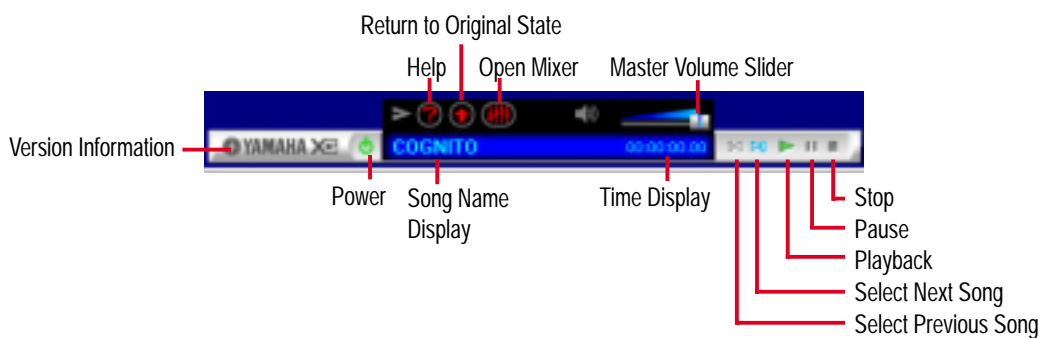

6. SOFTWARE REFERENCE

6.3.5 Troubleshooting

Cannot install

- Do you have the required hardware, such as hard disk and memory?
- Do you have the required software, such as MS-DOS and Windows?
- Installation may not be possible if you have insufficient space on your hard disk. Delete unneeded files to increase the free space on your disk.

Does not start

- Do you have the required hardware, such as hard disk and memory?
- Do you have the required software, such as MS-DOS and Windows?
- Were you able to install using the specified procedure?

No sound

- Is the MIDI driver correctly installed?
- Is the tone generator set correctly?
- Is volume set to zero in the XGstudio Player or XGstudio Mixer panels?
- If you are using an external tone generator, is the serial or MIDI cable and the audio cables connected correctly?
- Are the volumes of your tone generator, audio playback system, and application raised?
- If you have connected an external tone generator via a serial cable, is the rear panel select switch set correctly? (For the name of the select switch, refer to the owner's manual for your external tone generator.)
- If you are using a Soft Synthesizer, is it set so that the computer sound output is heard correctly?

7. APPENDIX

7.1 PCI-L101 Fast Ethernet Card

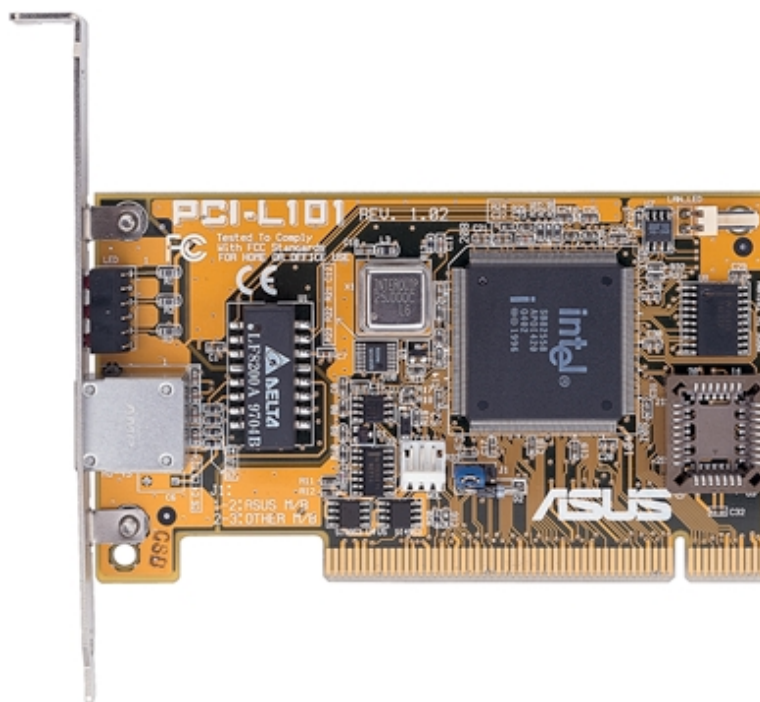

7. APPENDIX
ASUS LAN Card

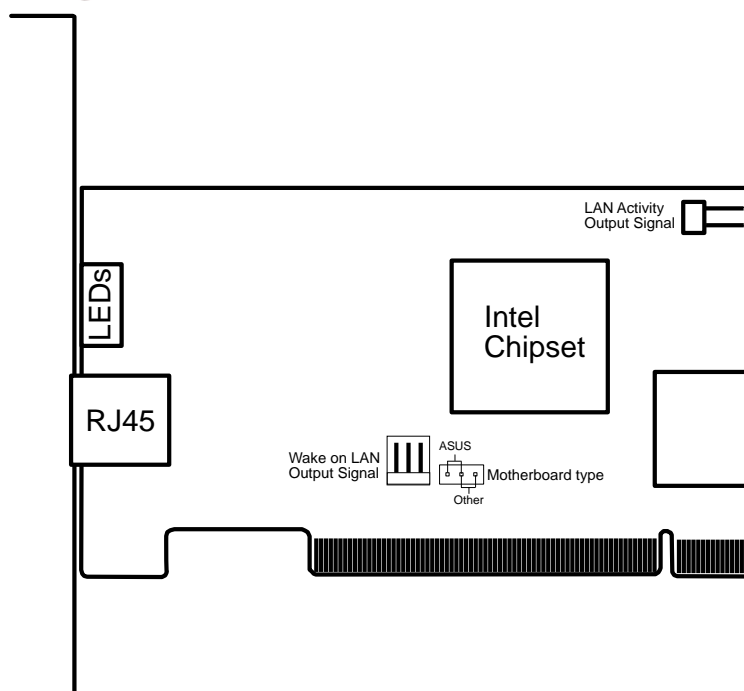

If you are using the ASUS PCI-L101 on an ASUS motherboard, leave the jumper on its default setting of “ASUS.” If you are using another brand of motherboard, set the jumper to “Other.” Connect the Wake on LAN (WOL) output signal to the motherboard’s WOL_CON in order to utilize the wake on LAN feature of the motherboard. Connect the LAN activity output signal (LAN_LED) to the system cabinet’s front panel LAN_LED in order to display the LAN data activity.

7. APPENDIX

7.1.1 Features

- Intel 82558 Ethernet LAN Controller (Fully integrated 10BASE-T/100BASE-TX)
- Wake-On-LAN Remote Control Function Supported
- PCI Bus Master Complies to PCI Local Bus Rev. 2.1 specifications
- Consists of MAC & PHY (10/100Mbps) interfaces
- Complies to IEEE 802.3 10BASE-T and IEEE 802.3u 100BASE-TX interfaces
- Fully supports 10BASE-T & 100BASE-TX operations through a single RJ45 port
- Supports 32-bit Bus Master Technology / PCI Rev. 2.1
- Enhancements on ACPI & APM
- Adheres to PCI Bus Power Management Interface Rev. 1.0, ACPI Rev. 1.0, and Device Class Power Management Rev. 1.0
- IEEE 802.3u auto-negotiation for 10Mbps/100Mbps Network Data Transfer Rates.
- Provides LED indicators for monitoring network conditions
- Plug and Play

7.1.2 Software Driver Support

- **NetWare ODI Drivers** - Novell Netware 3.x, 4.x, DOS, OS/2 Client
- **NDIS 2.01 Drivers** - Microsoft LAN Manager, Microsoft Windows 3.11, IBM LAN Server
- **NDIS 3.0 Drivers** - Microsoft Windows NT, Microsoft Windows 95, Microsoft Windows 3.11

7.1.3 Question and Answer

Q: What is Wake-On-LAN ?

A: The Wake-On-LAN feature provides the capability to remotely power on systems supporting Wake-On-LAN by simply sending a wake-up frame. With this feature, remotely uploading/downloading data to/from systems during off-peak hours will be feasible.

Q: What can Wake-On-LAN do for you ?

A: Wake-On-LAN is a remote management tool with advantages that can reduce system management workload, provide flexibility to the system administrator's job, and then of course save you time-consuming efforts and costs.

Q: What components does Wake-On-LAN require to be enable?

A: To enable Wake-On-LAN function, your system requires Ethernet LAN adapter card that can activate Wake-On-LAN function, a client with Wake-On-LAN capability, and software such as LDCM Rev. 3.10 or up that can trigger wake-up frame.

7. APPENDIX

7.2 Modem Riser

7.2.1 56K Software Modem

The Modem Riser (MR) is a high-speed PC communication peripheral which works with AMC'97/MC'97 compliant codecs. With this software modem, you can connect your computer to a remote location, receiving data at up to 56 Kbps in V.90 or K56flex modes.

7.2.2 Primary/Secondary MR

There are two types of modem risers: primary MR and secondary MR. In appearance, the primary MR has a crystal onboard but the secondary does not. If your motherboard has an audio codec and no PCI audio chipset onboard, you may use the secondary MR; otherwise, you should use the primary MR.

Layout of Primary MR

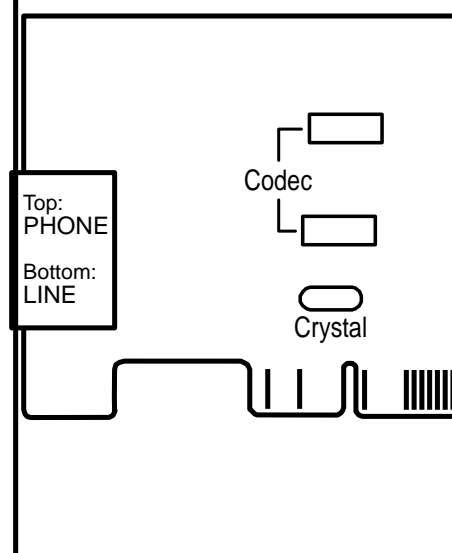

7. APPENDIX
Modem Riser

7.2.3 Hardware Installation Procedure



1. Power OFF your computer.
2. Open the computer chassis and remove the metal plate on the AMR expansion slot.
3. Carefully align the MR card's connector to the AMR slot and press firmly.
4. Secure the MR card onto the chassis with the screw removed in step 2.
5. Connect the MR card's **LINE** connector to a telephone wall jack. Connect the **PHONE** connector to a telephone (optional).
6. Replace the computer chassis.

7. APPENDIX

7.2.4 Software Setup in Windows 98

The Modem Riser supports the Plug and Play feature. It allows your computer to automatically set the optimal configurations for the MR and communication software. Follow the procedure below to install the modem driver.

1. Power ON the computer after the hardware installation is completed.
2. Windows 98 will automatically detect the modem and display a “PCI Card” message under “Add New Hardware Found”.
3. Select **Search for the best driver for your device** and click **Next**.
4. Insert the Support CD that came with your motherboard into your CD-ROM drive. Enter the path **E:\Modem\Win98** (assuming that your CD-ROM drive is drive E:) for the MR driver.
5. After the driver is located, click **Next** and then click **Finish**.
6. Restart your computer. Double click the modem icon at the bottom-right corner of the window. 
7. Click the **Settings** tab. Select your country and language. Click **OK**.
8. Click **Start**, point to **Settings**, click **Control Panel**, double click **Modems**, click the **General** tab, and click **Motorola SM56 AC-L Modem**.
9. Click **Diagnostic** and then click the designated COM port as shown.
10. Click **More Info...**. If the computer system successfully communicates with the modem, responses will be displayed as shown.

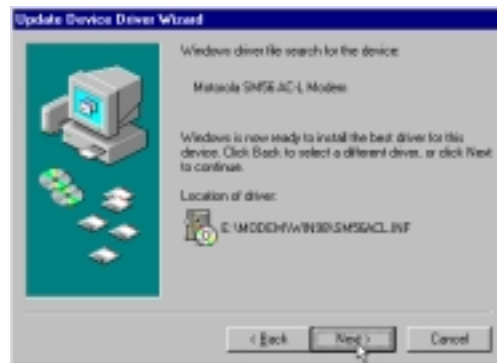
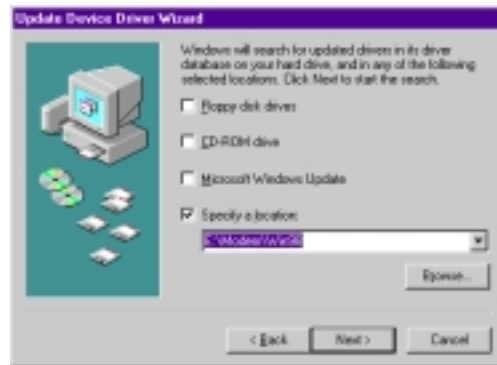

7. APPENDIX

7.3 Glossary

1394

1394 is the IEEE designation for the high performance serial bus at 12.5, 25 or 50MBytes/sec speeds. This serial bus defines both a back plane physical layer and a point-to-point cable-connected virtual bus. The primary application of the cable version is the integration of I/O connectivity at the back panel of personal computers using a low-cost, scalable, high-speed serial interface. The 1394 standard also provides new services such as live connect/disconnect capability for external devices including disk drives, printers and hand-held peripherals such as scanners and cameras. This is a new standard to complement the slower USB interface and to compete with the more expensive SCSI interface.

AC97 (Audio Codec '97)

AC '97 is the next step in enabling PCs with audio quality comparable to consumer electronics devices. The specification defines new cost-effective options to help integrate the components necessary to support next-generation auto-intensive PC applications such as DVD, 3-D multiplayer gaming and interactive music. The specification also defines new extensions supporting modem and docking to help both desktop and mobile manufacturers adopt these new technologies more quickly and cost-effectively. This specification uses software emulation to compete with the PCI SoundBlaster specification.

ACPI (Advanced Configuration and Power Interface)

The ACPI specification defines a cross-platform interface designed to support many operating systems. ACPI defines a flexible and abstract hardware interface that provides a standard way to integrate power management features throughout a PC system, including hardware, operating system and application software. This enables the system to automatically turn ON and OFF peripherals such as CD-ROMs, network cards, hard disk drives, and printers, as well as consumer devices connected to the PC such as VCRs, TVs, phones, and stereos. With this technology, peripherals will also be able to activate the PC. For example, inserting a tape into a VCR can turn on the PC, which could then activate a large-screen TV and high-fidelity sound system.

AGP (Accelerated Graphics Port)

An interface specification that enables high-performance 3D graphics on mainstream PCs. AGP was designed to offer the necessary bandwidth and latency to perform texture mapping directly from system memory.

Bus	Bus Frequency	Bandwidth	Data Transfer Rate
PCI	33MHz	33MHz	133MByte/sec
AGP 1X	66MHz	66MHz	266MByte/sec
AGP 2X	66MHz	133MHz	512MByte/sec
AGP 4X	66MHz	266MHz	1024MByte/sec

BIOS (Basic Input/Output System)

BIOS is a set of routines that affect how the computer transfers data between computer components, such as memory, disks, and the display adapter. The BIOS instructions are built into the computer's read-only memory. BIOS parameters can be configured by the user through the BIOS Setup program. The BIOS can be updated using the provided utility to copy a new BIOS file into the EEPROM.

Bit (Binary Digit)

Represents the smallest unit of data used by the computer. A bit can have one of two values: 0 or 1.

7. APPENDIX

Boot

Boot means to start the computer operating system by loading it into system memory. When the manual instructs you to “boot” your system (or computer), it means to turn ON your computer. “Reboot” means to restart your computer. When using Windows 95 or later, selecting “Restart” from “Start | Shut Down...” will reboot your computer.

Bus Master IDE

PIO (Programmable I/O) IDE requires that the CPU be involved in IDE access and waiting for mechanical events. Bus master IDE transfers data to/from the memory without interrupting the CPU. Bus master IDE driver and bus master IDE hard disk drives are required to support bus master IDE mode.

Byte (Binary Term)

One byte is a group of eight contiguous bits. A byte is used to represent a single alphanumeric character, punctuation mark, or other symbol.

COM Port

COM is a logical device name used by to designate the computer serial ports. Pointing devices, modems, and infrared modules can be connected to COM ports. Each COM port is configured to use a different IRQ and address assignment.

Concurrent PCI

Concurrent PCI maximizes system performance with simultaneous CPU, PCI and ISA bus activities. It includes multi-transaction timing, enhanced write performance, a passive release mechanism and support for PCI 2.1 compliant delayed transactions. Concurrent PCI provides increased bandwidth, reduced system latencies, improves video and audio performance, and improves processing of host based applications.

CPU (Central Processing Unit)

The CPU, sometimes called “Processor,” actually functions as the “brain” of the computer. It interprets and executes program commands and processes data stored in memory. Currently, there are socket 370 (for Pentium III FC-PGA and Celeron-PPGA), socket 7 (for Pentium, AMD, Cyrix, IBM), slot 1 (for Pentium II and III), slot 2 (for Xeon), and slot A (for AMD) processors.

Device Driver

A device driver is a special set of instructions that allows the computer’s operating system to communicate with devices such as VGA, audio, printer, or modem.

DOS (Disk Operating System)

DOS is the foundation on which all other programs and software applications operate, including Windows. DOS is responsible for allocating system resources such as memory, CPU time, disk space, and access to peripheral devices. For this reason, DOS constitutes the basic interface between you and your computer.

DRAM (Dynamic Random Access Memory)

There are several different types of DRAM such as, EDO DRAM (Extended Data Output DRAM), SDRAM (Synchronous DRAM), and RDRAM (Rambus DRAM).

Flash ROM

The flash ROM is designed to be a resident program and can be updated by a specific programming method. Normally, the flash ROM is used for system BIOS which initiates hardware devices and sets up necessary parameters for the OS. Since the contents of flash ROM can be modified, users are able to update the BIOS by themselves.

IDE (Integrated Drive Electronics)

IDE devices integrate the drive control circuitry directly on the drive itself, eliminating the need for a separate adapter card (in the case for SCSI devices). UltraDMA/33 IDE devices can achieve up to 33MB/Sec transfer.

7. APPENDIX

LPT Port (Line Printer Port)

Logical device name reserved by DOS for the computer parallel ports. Each LPT port is configured to use a different IRQ and address assignment.

MMX

A set of 57 new instructions based on a technique called Single Instruction, Multiple Data (SIMD), which is built into the new Intel Pentium PP/MT (P55C) and Pentium II (Klamath) CPU as well as other x86-compatible microprocessors. The MMX instructions are designed to accelerate multimedia and communications applications, such as 3D video, 3D sound, video conference.

OnNow

The OnNow design initiative is a comprehensive, system-wide approach to system and device power control. OnNow is a term for PC that is always ON but appears OFF and responds immediately to user or other requests. The OnNow design initiative involves changes that will occur in the Microsoft Windows operating system, device drivers, hardware, and applications, and also relies on the changes defined in the Advanced Configuration and Power Interface (ACPI) specification.

PC100

SDRAM is Intel's goal is to ensure that memory subsystems continue to support evolving platform requirements and to assure that memory does not become a bottleneck to system performance. It is especially important to ensure that the PC memory roadmap evolves together with the performance roadmaps for the processors, I/O and graphics.

PCI Bus (Peripheral Component Interconnect Local Bus)

PCI bus is a specification that defines a 32-bit data bus interface. PCI is a standard widely used by expansion card manufacturers.

PCI Bus Master

The PCI Bus Master can perform data transfer without local CPU help and furthermore, the CPU can be treated as one of the Bus Masters. PCI 2.1 supports concurrent PCI operation to allow the local CPU and bus master to work simultaneously.

Plug and Play BIOS

The ISA bus architecture requires the allocation of memory and I/O address, DMA channels and interrupt levels among multiple ISA cards. However, configuration of ISA cards is typically done with jumpers that change the decode maps for memory and I/O space and steer the DMA and interrupt signals to different pins on the bus. Further, system configuration files may need to be updated to reflect these changes. Users typically resolve sharing conflicts by referring to documentation provided by each manufacturer. For the average user, this configuration process can be unreliable and frustrating. Plug and play (PnP) BIOS eliminates the ISA add-on card hardware conflict problem. The PnP BIOS uses a memory block to define and remember each card's configuration, which allows the user to change the card's IRQs and DMA in BIOS either automatically or manually.

POST (Power On Self Test)

When you turn ON the computer, it will first run through the POST, a series of software-controlled diagnostic tests. The POST checks system memory, the motherboard circuitry, the display, the keyboard, the diskette drive, and other I/O devices.

PS/2 Port

PS/2 ports are based on IBM Micro Channel Architecture. This type of architecture transfers data through a 16-bit or 32-bit bus. A PS/2 mouse and/or keyboard may be used on ATX motherboards.

RDRAM (Rambus DRAM)

Developed by Rambus, Inc., this type of memory can deliver up to 1.6GB of data per second. RDRAM is the first interface standard that can be directly implemented on high performance VLSI components such as, CMOS DRAMs, memory controllers, and graphics/video ICs.

7. APPENDIX

ROM (Read Only Memory)

ROM is nonvolatile memory used to store permanent programs (called firmware) used in certain computer components. Flash ROM (or EEPROM) can be reprogrammed with new programs (or BIOS).

SCSI (Small Computer System Interface)

High speed multi-threaded I/O interface defined by the X3T9.2 committee of the American National Standards Institute (ANSI) for connecting many peripheral devices. The standard started from 10MBytes/sec to 160MBytes/sec available today.

SDRAM (Synchronous DRAM)

The SDRAM features a fully synchronous operation referenced to a positive edge clock whereby all operations are synchronized at a clock input which enables the coexistence of high performance and a simple user interface. SDRAM takes memory access away from the CPU's control; internal registers in the chips accept the request, and let the CPU do something else while the data requested is assembled for the next time the CPU talks to the memory. As they work on their own clock cycle, the rest of the system can be clocked faster. There is a version optimized for video cards, and main memory for motherboards.

SPD for SDRAM module

Serial Presence Detect (SPD) is most like an ID detect for SDRAM module, it using a EEPROM component on DIMM module for storing module configuration information inside. The Serial Presence Detect function is implemented using a 2048 bit EEPROM component. This nonvolatile storage device contains data programmed by the DIMM manufacturer that identifies the module type and various SDRAM organization and timing parameters.

SSE (Streaming SIMD Extensions)

A set of new instructions added to existing architectures that enables a better visual experience with an accelerated 3D geometry pipeline and support for new applications, such as real-time video encoding and speech recognition.

System Disk

A system disk contains the core file of an operating system and is used to boot up the operating system.

UltraDMA

Ultra DMA/33 is a "synchronous DMA" protocol designed by Intel. This function is included into Intel's PIIX4 chipset. The traditional IDE transfer only uses one edge of the data stroke as the data transfer. Ultra DMA/33 uses both edges of data strobe when the data is transferred. Hence, the data transfer rate is double of the PIO mode 4 or DMA mode 2 (16.6MB/s x2 = 33MB/s) on ATA-2 devices.

Ultra ATA/66, also known as Ultra DMA/66, is an extension of current Ultra ATA/33 interface. This new high-speed interface has doubled the Ultra ATA/33 burst data transfer rate to 66.6 Mbytes/sec and maximized disk performance under current PCI local bus environment

USB (Universal Serial Bus)

A 4-pin serial cable bus that allows up to 127 plug and play computer peripherals such as keyboard, mouse, joystick, scanner, printer, modem, and monitor to share a bandwidth through a host scheduled token based protocol. This allows attaching or detaching while the host and other peripherals are in operation. Supports synchronous and asynchronous transfer types over the same set of wires up to 12Mbit/sec. USB 2.0 provides twice the transfer rate compared to USB 1.0 and competes with the 1394 standard.

Wake-On-LAN

Computer will automatically wake-up upon receiving a wake-up packet through a Network interface when it is under power soft-off, suspend or sleep mode.