

**CROSSBLADE
RANGER**

ASUS[®]

Motherboard

Copyright © 2014 ASUSTeK COMPUTER INC. All Rights Reserved.

No part of this manual, including the products and software described in it, may be reproduced, transmitted, transcribed, stored in a retrieval system, or translated into any language in any form or by any means, except documentation kept by the purchaser for backup purposes, without the express written permission of ASUSTeK COMPUTER INC. ("ASUS").

Product warranty or service will not be extended if: (1) the product is repaired, modified or altered, unless such repair, modification or alteration is authorized in writing by ASUS; or (2) the serial number of the product is defaced or missing.

ASUS PROVIDES THIS MANUAL "AS IS" WITHOUT WARRANTY OF ANY KIND, EITHER EXPRESS OR IMPLIED, INCLUDING BUT NOT LIMITED TO THE IMPLIED WARRANTIES OR CONDITIONS OF MERCHANTABILITY OR FITNESS FOR A PARTICULAR PURPOSE. IN NO EVENT SHALL ASUS, ITS DIRECTORS, OFFICERS, EMPLOYEES OR AGENTS BE LIABLE FOR ANY INDIRECT, SPECIAL, INCIDENTAL, OR CONSEQUENTIAL DAMAGES (INCLUDING DAMAGES FOR LOSS OF PROFITS, LOSS OF BUSINESS, LOSS OF USE OR DATA, INTERRUPTION OF BUSINESS AND THE LIKE), EVEN IF ASUS HAS BEEN ADVISED OF THE POSSIBILITY OF SUCH DAMAGES ARISING FROM ANY DEFECT OR ERROR IN THIS MANUAL OR PRODUCT.

SPECIFICATIONS AND INFORMATION CONTAINED IN THIS MANUAL ARE FURNISHED FOR INFORMATIONAL USE ONLY, AND ARE SUBJECT TO CHANGE AT ANY TIME WITHOUT NOTICE, AND SHOULD NOT BE CONSTRUED AS A COMMITMENT BY ASUS. ASUS ASSUMES NO RESPONSIBILITY OR LIABILITY FOR ANY ERRORS OR INACCURACIES THAT MAY APPEAR IN THIS MANUAL, INCLUDING THE PRODUCTS AND SOFTWARE DESCRIBED IN IT.

Products and corporate names appearing in this manual may or may not be registered trademarks or copyrights of their respective companies, and are used only for identification or explanation and to the owners' benefit, without intent to infringe.

Offer to Provide Source Code of Certain Software

This product contains copyrighted software that is licensed under the General Public License ("GPL"), under the Lesser General Public License Version ("LGPL") and/or other Free Open Source Software Licenses. Such software in this product is distributed without any warranty to the extent permitted by the applicable law. Copies of these licenses are included in this product.

Where the applicable license entitles you to the source code of such software and/or other additional data, you may obtain it for a period of three years after our last shipment of the product, either

(1) for free by downloading it from <http://support.asus.com/download>

or

(2) for the cost of reproduction and shipment, which is dependent on the preferred carrier and the location where you want to have it shipped to, by sending a request to:

ASUSTeK Computer Inc.
Legal Compliance Dept.
15 Li Te Rd.,
Beitou, Taipei 112
Taiwan

In your request please provide the name, model number and version, as stated in the About Box of the product for which you wish to obtain the corresponding source code and your contact details so that we can coordinate the terms and cost of shipment with you.

The source code will be distributed WITHOUT ANY WARRANTY and licensed under the same license as the corresponding binary/object code.

This offer is valid to anyone in receipt of this information.

ASUSTeK is eager to duly provide complete source code as required under various Free Open Source Software licenses. If however you encounter any problems in obtaining the full corresponding source code we would be much obliged if you give us a notification to the email address gpl@asus.com, stating the product and describing the problem (please DO NOT send large attachments such as source code archives, etc. to this email address).

Contents

Safety information.....	vi
About this guide.....	vii
CROSSBLADE RANGER specifications summary.....	ix
Package contents.....	xiii
Installation tools and components.....	xiv
Chapter 1: Product Introduction	
1.1 Special features.....	1-1
1.1.1 Product highlights.....	1-1
1.1.2 ROG Gaming Features.....	1-2
1.1.3 ROG Exclusive Features.....	1-3
1.1.4 ASUS Special Features.....	1-3
1.1.5 ROG rich bundled software.....	1-4
1.2 Motherboard overview.....	1-5
1.2.1 Before you proceed.....	1-5
1.2.2 Motherboard layout.....	1-6
1.2.3 Central Processing Unit (CPU).....	1-8
1.2.4 System memory.....	1-9
1.2.5 Expansion slots.....	1-21
1.2.6 Onboard buttons and switches.....	1-23
1.2.7 Jumpers.....	1-27
1.2.8 Onboard LEDs.....	1-27
1.2.9 Internal connectors.....	1-35
Chapter 2: Basic Installation	
2.1 Building your PC system.....	2-1
2.1.1 Motherboard installation.....	2-1
2.1.2 APU installation.....	2-3
2.1.3 APU heatsink and fan assembly installation.....	2-4
2.1.4 DIMM installation.....	2-6
2.1.5 ATX Power connection.....	2-7
2.1.6 SATA device connection.....	2-8
2.1.7 Front I/O Connector.....	2-9
2.1.8 Expansion Card installation.....	2-10
2.2 BIOS update utility.....	2-11
2.3 Motherboard rear and audio connections.....	2-12
2.3.1 Rear I/O connection.....	2-12
2.3.2 Audio I/O connections.....	2-13
2.4 Starting up for the first time.....	2-17
2.5 Turning off the computer.....	2-17

Chapter 3: BIOS setup

3.1	Knowing BIOS	3-1
3.2	BIOS setup program	3-2
	3.2.1 EZ Mode	3-3
	3.2.2 Advanced Mode	3-4
3.3	My Favorites	3-7
3.4	Extreme Tweaker menu	3-8
3.5	Main menu	3-15
3.6	Advanced menu	3-18
	3.6.1 CPU Configuration	3-19
	3.6.2 SATA Configuration	3-20
	3.6.3 USB Configuration	3-22
	3.6.4 NB Configuration	3-23
	3.6.5 Onboard Devices Configuration	3-24
	3.6.6 APM Configuration	3-25
	3.6.7 Network Stack	3-26
	3.6.8 ROG Effects	3-26
3.7	Monitor menu	3-27
3.8	Boot menu	3-30
3.9	Tool menu	3-36
	3.9.1 ASUS EZ Flash 2 Utility	3-36
	3.9.2 Secure Erase	3-36
	3.9.3 Setup Animator [Disabled]	3-37
	3.9.4 Graphics Card Information	3-37
	3.9.5 ASUS Overclocking Profile	3-38
	3.9.6 ASUS SPD Information	3-39
3.10	Exit menu	3-40
3.11	Updating BIOS	3-41

Chapter 4: Software support

4.1	Installing an operating system	4-1
4.2	Support DVD information	4-1
	4.2.1 Running the support DVD	4-1
	4.2.2 Obtaining the software manuals	4-2
4.3	Software information	4-3
4.4	AI Suite 3	4-3
4.5	Dual Intelligent Processors 5	4-6
4.6	ROG audio features	4-22
4.7	Sonic Radar II	4-28

4.8	GameFirst III	4-30
4.9	KeyBot.....	4-33
4.10	ASUS Media Streamer	4-35
4.11	ASUS Disk Unlocker	4-37
4.12	RAMDisk	4-38
4.13	MemTweakIt.....	4-41
4.14	ROG CPU-Z.....	4-43

Chapter 5: RAID support

5.1	RAID configurations	5-1
5.1.1	RAID definitions	5-1
5.1.2	Installing Serial ATA hard disks	5-2
5.1.3	Setting the RAID item in BIOS	5-2
5.2	Install the RAID driver during Windows® OS installation.....	5-6

Appendices

Notices	A-1
ASUS contact information.....	A-4

Safety information

Electrical safety

- To prevent electrical shock hazard, disconnect the power cable from the electrical outlet before relocating the system.
- When adding or removing devices to or from the system, ensure that the power cables for the devices are unplugged before the signal cables are connected. If possible, disconnect all power cables from the existing system before you add a device.
- Before connecting or removing signal cables from the motherboard, ensure that all power cables are unplugged.
- Seek professional assistance before using an adapter or extension cord. These devices could interrupt the grounding circuit.
- Ensure that your power supply is set to the correct voltage in your area. If you are not sure about the voltage of the electrical outlet you are using, contact your local power company.
- If the power supply is broken, do not try to fix it by yourself. Contact a qualified service technician or your retailer.

Operation safety

- Before installing the motherboard and adding devices on it, carefully read all the manuals that came with the package.
- Before using the product, ensure all cables are correctly connected and the power cables are not damaged. If you detect any damage, contact your dealer immediately.
- To avoid short circuits, keep paper clips, screws, and staples away from connectors, slots, sockets and circuitry.
- Avoid dust, humidity, and temperature extremes. Do not place the product in any area where it may become wet.
- Place the product on a stable surface.
- If you encounter technical problems with the product, contact a qualified service technician or your retailer.

About this guide

This user guide contains the information you need when installing and configuring the motherboard.

How this guide is organized

This guide contains the following parts:

- **Chapter 1: Product introduction**
This chapter describes the features of the motherboard and the new technology it supports. It includes description of the switches, jumpers, and connectors on the motherboard.
- **Chapter 2: Basic Installation**
This chapter lists the hardware setup procedures that you have to perform when installing system components.
- **Chapter 3: BIOS setup**
This chapter tells how to change system settings through the BIOS Setup menus. Detailed descriptions of the BIOS parameters are also provided.
- **Chapter 4: Software support**
This chapter describes the contents of the support DVD that comes with the motherboard package and the software.
- **Chapter 5: RAID support**
This chapter describes the RAID configurations.

Where to find more information

Refer to the following sources for additional information and for product and software updates.

1. **ASUS website**
The ASUS website (www.asus.com) provides updated information on ASUS hardware and software products.
2. **Optional documentation**
Your product package may include optional documentation, such as warranty flyers, that may have been added by your dealer. These documents are not part of the standard package.

Conventions used in this guide

To ensure that you perform certain tasks properly, take note of the following symbols used throughout this manual.



DANGER/WARNING: Information to prevent injury to yourself when trying to complete a task.



CAUTION: Information to prevent damage to the components when trying to complete a task



IMPORTANT: Instructions that you **MUST** follow to complete a task.



NOTE: Tips and additional information to help you complete a task.

Typography

Bold text

Indicates a menu or an item to select.

Italics

Used to emphasize a word or a phrase.

<Key>

Keys enclosed in the less-than and greater-than sign means that you must press the enclosed key.

Example: <Enter> means that you must press the Enter or Return key.

<Key1> + <Key2> + <Key3>

If you must press two or more keys simultaneously, the key names are linked with a plus sign (+).

CROSSBLADE RANGER specifications summary

CPU	<p>AMD® FM2+ Socket for AMD® A-series/Athlon™ Series processors Supports AMD® Turbo Core Technology 3.0 Supports up to 4 cores CPU</p> <p>* Refer to www.asus.com for AMD CPU support list.</p>
Chipset	<p>AMD® A88X FCH (Bolton-D4)</p>
Memory	<p>Dual channel memory architecture 4 x DDR3 DIMM, max. 64GB, DDR3 2666 (O.C.) / 2400 (O.C.) / 2250 (O.C.) / 2200 (O.C.) / 2133 / 1866 / 1600 / 1333 MHz, non-ECC, un-buffered memory Supports AMD® Memory Profile (AMP) memory</p> <p>* The max. 64GB memory capacity can be supported with DIMMs of 16GB (or above). ASUS will update the QVL once the DIMMs are available on the market.</p> <p>** Hyper DIMM support is subject to the physical characteristics of individual CPUs.</p> <p>*** Refer to www.asus.com or this user manual for the memory QVL (Qualify Vendor List).</p>
Expansion slots	<p>2 x PCI Express 3.0*/2.0 x16 slots (Red, single at x16 or dual at x8/x8 mode) 1 x PCI Express 2.0 x16 slot (Black, max. at x4 mode) 2 x PCI Express 2.0 x1 slots 2 x PCI slots</p> <p>* Only FM2+ processors can support PCIe 3.0 speed rate.</p>
Graphics	<p>Integrated AMD® Radeon™ HD8000/7000 Series Graphics in A-series APU</p> <p>Multi-VGA output support: HDMI/DVI/D-Sub port</p> <ul style="list-style-type: none"> - Supports HDMI with max. resolution of 4096x2160* @24Hz / 1920x1200 @60Hz - Supports Dual-link DVI with max. resolution of 2560x1600 @60Hz - Supports D-Sub with max. resolution of 1920x1600 @60Hz - Maximum shared memory of 2GB - Supports AMD® Dual Graphics technology <p>* Only FM2+ APU can support up to 4096 x 2160 resolution display via the HDMI port.</p> <p>** Refer to www.amd.com for the discrete GPUs which support Dual Graphics technology.</p>
Multi-GPU support	<p>Support AMD® 3-Way CrossFireX™ Technology</p>
Storage	<p>AMD® A88X FCH:</p> <ul style="list-style-type: none"> - 8 x Serial ATA 6Gb/s connectors with RAID 0, RAID 1, RAID 5, RAID 10 and JBOD support
LAN	<p>Intel® Gigabit LAN controller Anti-surge LANGuard ROG GameFirst III</p>

(continued on the next page)

CROSSBLADE RANGER specifications summary

<p>Audio</p>	<p>ROG SupremeFX Audio 8-Channel High Definition Audio</p> <ul style="list-style-type: none"> - SupremeFX Shielding Technology - ELNA® Premium Audio Capacitors - Content Protection for Full Rate lossless DVD Audio, Blu-ray DVD, and HD-DVD audio content playback - Jack-detection, Multi-streaming, and Front Panel Jack-retasking, - Optical S/PDIF out port at back panel <p>Audio Features:</p> <ul style="list-style-type: none"> - Sonic Radar II - Sonic Studio - Sonic SoundStage - Sonic SenseAmp - DTS Connect
<p>USB</p>	<p>ASMedia® USB 3.0 controller:</p> <ul style="list-style-type: none"> - 2 x USB 3.0 ports (2 ports at back panel, Blue) <p>AMD® A88X FCH:</p> <ul style="list-style-type: none"> - 4 x USB 3.0 ports (2 ports at back panel, Blue; 2 ports at mid-board, Red) - 8 x USB 2.0 ports (2 ports at back panel, 6 ports at mid-board)
<p>ROG Exclusive Features</p>	<p>Extreme Engine Digi+ III:</p> <ul style="list-style-type: none"> - Full digital CPU/DRAM power - NexFET™ Power Block MOSFET - New Alloy Chokes - 10K Black Metallic Capacitors <p>KeyBot:</p> <ul style="list-style-type: none"> - CPU Level Up - XMP - DirectKey <p>ROG Extreme OC kit:</p> <ul style="list-style-type: none"> - LN2 mode - Slow mode <p>Probit</p> <p>UEFI BIOS features:</p> <ul style="list-style-type: none"> - Extreme Tweaker - Tweaker's Paradise - ROG SSD Secure Erase - GPU.DIMM Post - O.C. Profile - Graphics Card information Preview <p>ROG USB BIOS FlashBack</p> <p>ROG RAMDisk</p>

(continued on the next page)

CROSSBLADE RANGER specifications summary

<p>ASUS Unique Features</p>	<p>ASUS Dual Intelligent Processors 5</p> <ul style="list-style-type: none"> - 5-Way Optimization tuning key perfectly consolidates TPU, EPU, DIGI+ Power Control, Fan Xpert 3, and Turbo App <p>ASUS Exclusive Features</p> <ul style="list-style-type: none"> - AI Suite 3 - MemOK! - USB 3.0 Boost - USB Charger+ - AI Charger+ - HomeCloud - Push Notice - Disk Unlocker <p>ASUS Quiet Thermal Solution</p> <ul style="list-style-type: none"> - ASUS Fanless Design: Stylish Heatpipe & MOS Heatsink Solution - ASUS Fan Xpert3 <p>ASUS EZ DIY</p> <ul style="list-style-type: none"> - ASUS UEFI BIOS EZ Mode featuring friendly graphics user interface - ASUS CrashFree BIOS 3 - ASUS EZ Flash 2 <p>ASUS Q-Design</p> <ul style="list-style-type: none"> - ASUS Q-Code, Q-Shield, Q-Connector, Q-LED, Q-Slot, Q-DIMM
<p>Back I/O Ports</p>	<p>1 x PS/2 keyboard/mouse combo port</p> <p>2 x USB 2.0 ports</p> <p>1 x USB BIOS Flashback button</p> <p>1 x Optical S/PDIF out</p> <p>1 x HDMI port</p> <p>1 x RGB (VGA) port</p> <p>1 x DVI-D (DVI) port</p> <p>4 x USB 3.0 ports (Blue)</p> <p>1 x Anti-surge LAN (RJ45) port</p> <p>6 x 8-channel golden plated audio jacks</p>

(continued on the next page)

CROSSBLADE RANGER specifications summary

Internal Connectors	<ul style="list-style-type: none"> 1 x USB 3.0 connector (supports additional two USB 3.0 ports) 3 x USB 2.0 connectors (support additional six USB 2.0 ports, two connectors share with ROG_EXT header) 1 x ROG Extension (ROG_EXT) header 8 x SATA 6Gb/s connectors 1 x 4-pin CPU fan connector 1 x 4-pin CPU optional fan connector 3 x 4-pin Chassis fan connectors 1 x 24-pin EATX power connector 1 x 8-pin EATX 12V Power connector 1 x Clear CMOS button 1 x Power-on button 1 x Reset button 1 x MemOK! button 1 x Slow mode 1 x LN2 mode 1 x DRCT header 1 x Front panel audio connector (AAFP) 1 x System panel connector 7 x Probelts measurement points 1 x TPM connector 1 x Sonic SoundStage button 1 x KeyBot button
BIOS Features	<p>64 Mb Flash ROM, UEFI AMI BIOS, PnP, DMI 2.7, WfM 2.0, SM BIOS 2.7, ACPI 5.0, Multi-language BIOS, ASUS EZ Flash 2, ASUS CrashFree BIOS 3, My Favorites, Quick Note, Last Modified log, F12 PrintScreen, F3 Shortcut functions, and ASUS DRAM SPD (Serial Presence Detect) memory information</p>
Operating System	<ul style="list-style-type: none"> Windows® 8.1 Windows® 8 Windows® 7
Software	<ul style="list-style-type: none"> Drivers ROG GameFirst III ROG RAMDisk ROG CPU-Z Kaspersky® Anti-Virus DAEMON Tools Pro Standard ASUS WebStorage Home Cloud ASUS Utilities
Form Factor	<p>ATX Form Factor, 12 in. x 9.6 in. (30.5 cm x 24.4 cm)</p>



Specifications are subject to change without notice.

Package contents



Check your motherboard package for the following items.

Motherboard	ROG CROSSBLADE RANGER
Cables	2 x 2-in-1 SATA 6 Gb/s cables
Accessories	1 x I/O Shield
	1 x 12-in-1 ROG cable label
	1 x 2-in-1 Q-Connector kit
	1 x ROG Door Hanger
	1 x ROG Mouse Mat
Application DVD	ROG motherboard support DVD
Documentation	User guide

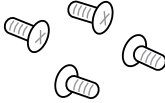

If any of the above items is damaged or missing, contact your retailer.

Installation tools and components

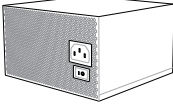
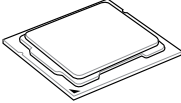
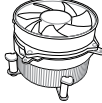
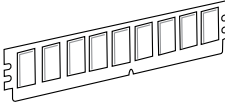
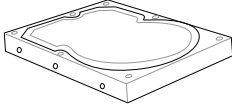
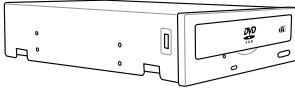
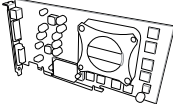
	
1 bag of screws	Phillips (cross) screwdriver
	
PC chassis	Power supply unit
	
AMD FM2+ CPU	AMD FM2+ compatible CPU Fan
	
DDR3 DIMM	SATA hard disk drive
	
SATA optical disc drive (optional)	Graphics card (optional)



The tools and components in the table above are not included in the motherboard package.

Product introduction

1

1.1 Special features

1.1.1 Product highlights

Republic of Gamers

The Republic of Gamers offers you the best of the best. We offer the best hardware engineering, the fastest performance, the most innovative ideas, and we welcome the best gamers to join in. In the Republic of Gamers, mercy rules are only for the weak, and bragging rights means everything. We believe in making statements and we excel in competitions. If your character matches our trait, then join the elite Republic of Gamers and make your presence felt.

AMD® A-series accelerated processors with AMD® Radeon™ HD8000/HD7000 Series graphics

This motherboard supports AMD® A-series accelerated processor with AMD® Radeon™ HD8000/HD7000 Series graphics. This revolutionary APU (Accelerated Processing Unit) combines processing power, energy-efficient design to enable accelerated performance and an industry-leading visual experience. It features Dual-channel DDR3 memory support and accelerates data transfer rate up to 5GT/s.

AMD® A88X FCH (Bolton-D4) chipset

AMD® A88X FCH (Bolton-D4) is designed to support up to 5GT/s interface speed and AMD® CrossFireX™ multi-GPU technology. It also supports 8 x SATA 6Gb/s ports and 4 x USB 3.0 ports.

PCIe® 3.0

PCIe® 3.0 (PCIe 3.0) is the PCIe bus standard that provides twice the performance and speed of PCIe 2.0. It provides an optimal graphics performance, unprecedented data speed and seamless transition with its complete backward compatibility to PCIe 1.0/2.0 devices.

CrossFire™ On-Demand

This motherboard features a unique PCIe 3.0 bridge chip to support CrossFireX™ multi-GPU graphics cards for an unrivalled gaming performance. With the AMD® A88X platform to optimize the PCIe allocation of multiple GPUs, it supports up to 3-WAY CrossFireX™ configuration.

Complete USB 3.0 integration

This motherboard offers you the strategic USB 3.0 accessibility for both the front and rear panels, allowing you to experience the convenience of the latest plug and play connectivity solution at speed up to ten times faster than USB 2.0.

1.1.2 ROG Gaming Features

SupremeFX 2014

The re-engineered ROG-exclusive SupremeFX audio technology features an onboard 8-channel high-definition sound of true audiophile-grade performance that is equal in power, clarity, and range to dedicated sound cards. Its unique Red Line Shielding and special metallic cover provides pristine sound and a highly attractive look for the motherboard that is in keeping with the ROG style. The Japan-made premium ELNA capacitor ensures warm natural sound with exceptional clarity for all your gaming and multimedia activities. SupremeFX revolutionizes the way you hear games, movies, music, and even other people via chat - letting you rule and discover a totally whole new dimension of superior audio.

Sonic Radar II

Sonic Radar II features the exclusive audio enhancement that enhances in-game sound for better hearing awareness. It has a customizable user interface with a stealthy overlay display that shows what opponents and teammates are up to including information on the precise direction and origin of gunshots, footsteps, and call-outs when playing first person shooting (FPS) games.

Sonic Studio

Sonic Studio is an audio tuning software that simulates 7.1 channels even through a stereo (2.0-channel) headset with its virtual surround-sound function. It comes with six superb audio controls including Reverb, Bass Boost, Equalizer, Voice Clarity, Smart EQ, and Virtual Surround.

Sonic SoundStage

Sonic SoundStage is an on-board solution that improves audio experience when you connect your front-panel headset. It works with any operating system and on any game. You can choose from any of the four presets or manually fine tune your own setting to fire up your game.

Sonic SenseAmp

Sonic SenseAmp is an exclusive ROG invention that automatically detects your headset's impedance and adjusts the built-in amp accordingly. Sonic SenseAmp makes tuning your high-quality headphones as simple as plugging them in.

GameFirst III

ASUS GameFirst III is a network management software that features four preset packet prioritized profiles (Optimization, Game, Media Streaming and File Sharing) facilitating user's need. Users can also manually allocate bandwidth and adjust priority settings of each application to run faster and smoother.

Intel® Ethernet

This LAN solution from Intel features high TCP and UDP throughput with lower CPU utilization for a smooth networking experience. It has advanced features including advanced interrupt-handling, low-power consumption, and Intel Stable Image Platform Program (SIPP) support thanks to its compatibility with the Intel CPU and chipset.

1.1.3 ROG Exclusive Features

Extreme Engine Digi+ III

Extreme Engine Digi+ III offers you a hardcore power delivery for a challenging and extreme gaming enjoyment. It utilizes the best components such as NexFET™ Power Block MOSFETs, new alloy chokes, and super-premium 10K black metallic solid state capacitors. The NexFET™ Power Block MOSFETs combine great durability and up to 90% efficiency under normal operation. Super-premium 10K Black Metallic solid state capacitors are forged for overclocking and the most extreme demands, lasting up to five times longer than generic capacitors with 20% wider temperature tolerance.

RAMDisk

RAMDisk reserves part of system memory and turns it into actual storage, so you can place favorite app and game cache files in it to enjoy high-speed RAM performance while accessing them. With the Dynamic Memory Allocation function, it can also release the unused memory of RAMDisk back to the system when needed. Plus, this extends SSD lifespan and keeps your main storage optimized for really important tasks, and you get auto data backup and restore.



NOTE: RAMDisk only supports 64-bit operating systems.

1.1.4 ASUS Special Features

AI Suite 3

With its user-friendly interface, ASUS AI Suite 3 consolidates all the exclusive ASUS features into one simple-to-use software package. It allows you to supervise fan speed control, voltage and sensor readings. This all-in-one software offers diverse and ease to use functions, with no need to switch back and forth between different utilities.

USB 3.0 Boost

ASUS USB 3.0 Boost, which supports USB 3.0 standard UASP (USB Attached SCSI Protocol), significantly increases a USB device's transfer speed up to 170% faster than the already impressive USB 3.0 transfer speed. It automatically accelerates data speeds for compatible USB 3.0 peripherals without the need for any user interaction.

USB BIOS Flashback

USB BIOS Flashback offers a hassle-free updating solution for your ultimate convenience. Install a USB storage device containing the BIOS file, press the BIOS Flashback button for about three seconds, and the UEFI BIOS is automatically updated even without entering the existing BIOS or operating system. It also allows you to regularly check for UEFI BIOS updates, and download the latest BIOS automatically.

Auto Tuning

ROG's Auto Tuning technology unleashes the true power of your AMD APU with just few clicks. No matter which kind of game you're playing, the friendly and intuitive interface helps you win on the battlefield. Enabled by the TurboV Processing Unit (TPU), Auto Tuning adjusts the CPU frequencies and ratios to offer precise voltage control and advanced CPU performance monitoring, efficiently enhancing system performance with the most stable overclocking profile — so you enjoy superb stability and high speeds while gaming.

1.1.5 ROG rich bundled software

KeyBot

KeyBot is a built-in microprocessor that provides instant upgrade to your keyboard. You can configure and assign macros to specific keys on your keyboard to perform specific or several task at the same time. You can also configure your PC to wake up in CPU Level UP, XMP, or directly to BIOS mode.



This feature supports USB keyboards only.

Kaspersky® Anti-Virus

Kaspersky® Anti-Virus Personal offers premium anti virus protection for individual users and home offices. It is based on advanced anti virus technologies. The product incorporates the Kaspersky® Anti-Virus engine, which is renowned for malicious program detection rates that are among the industry's highest.

DAEMON Tools Pro Standard

DAEMON Tools Pro offers essential functionality to backup CD, DVD and Blu-ray discs. It converts optical media into virtual discs and emulates devices to work with the virtual copies. DAEMON Tools Pro organizes data, music, video, and photo collections on a PC, notebook, or netbook.

ROG CPU-Z

ROG CPU-Z is a customized ROG version utility authorized by Intel's CPU Identification (CPUID) that allows you to gather information of the main devices of your system. It gives you the information and status of your CPU, motherboard, memory, and the whole component. Use the ROG look of reporting your system's current information with ROG CPU-Z.

MemTweakIt

MemTweakIt is a DRAM efficiency tool that allows you to read DRAM timings and allows you to post and share your DRAM configuration scores to the ROG website.

DTS Connect

To get the most out of your audio entertainment across all formats and quality levels, DTS Connect combines two enabling technologies, DTS Neo:PC™ up mixes stereo sources (CDs, MP3s, WMAs, internet radio) into as many as 7.1 channels of incredible surround sound. Consumers can connect their PC to a home theatre system. DTS Interactive is capable of performing multichannel encoding of DTS bitstreams on personal computers, and sending encoded bitstreams out of a digital audio connection (such as S/PDIF or HDMI) designed to deliver audio to an external decoder.

1.2 Motherboard overview

1.2.1 Before you proceed

Take note of the following precautions before you install motherboard components or change any motherboard settings.



-
- Unplug the power cord from the wall socket before touching any component.
 - Before handling components, use a grounded wrist strap or touch a safely grounded object or a metal object, such as the power supply case, to avoid damaging them due to static electricity.
 - Hold components by the edges to avoid touching the ICs on them.
 - Whenever you uninstall any component, place it on a grounded antistatic pad or in the bag that came with the component.
 - Before you install or remove any component, ensure that the ATX power supply is switched off or the power cord is detached from the power supply. Failure to do so may cause severe damage to the motherboard, peripherals, or components.
-

1.2.2 Motherboard layout

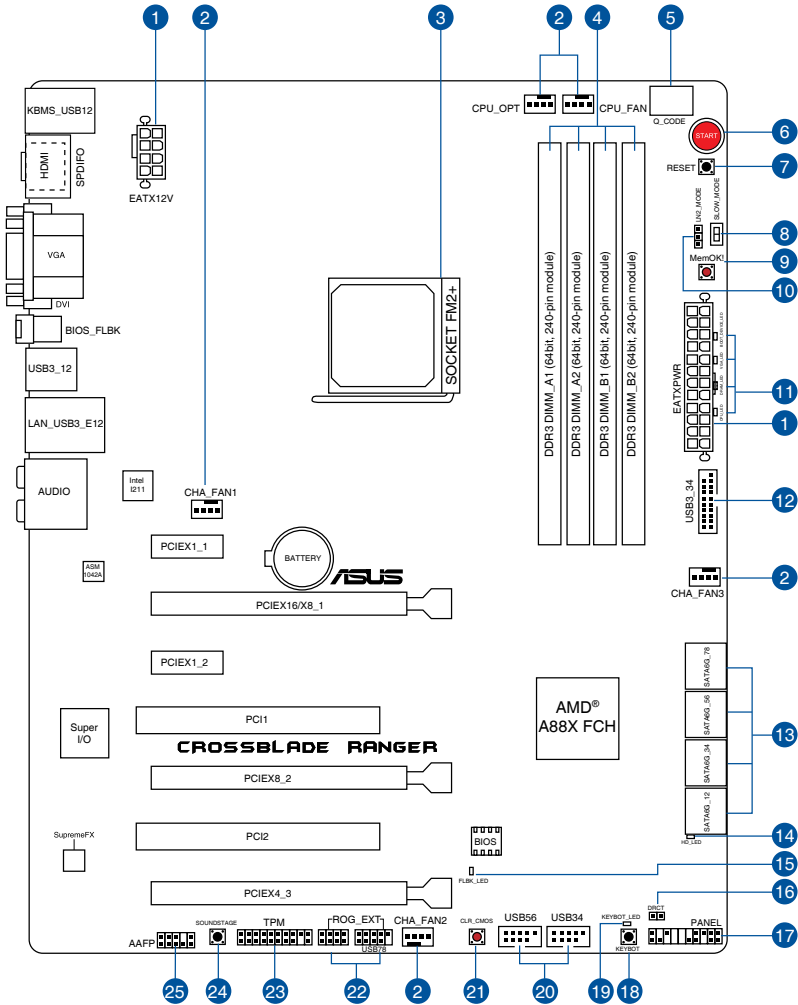

Refer to **Internal connectors** and **Rear I/O connection** for more information about rear panel connectors and internal connectors.

Layout contents

Connectors/Jumpers/Buttons and switches/Slots	Page
1. ATX power connectors (24-pin EATXPWR; 8-pin EATX12V)	1-40
2. CPU, chassis, and optional fan connectors (4-pin CPU_FAN; 4-pin CPU_OPT; 4-pin CHA_FAN1-3)	1-39
3. AMD FM2+ CPU Socket	1-8
4. DDR3 DIMM slots	1-9
5. Q_Code LED	1-29
6. Power-on button (START)	1-23
7. RESET button	1-23
8. Slow Mode switch	1-26
9. MemOK! button	1-24
10. LN2 Mode Jumper (3-pin LN2_MODE)	1-27
11. Q LEDs (BOOT_DEVICE_LED, VGA_LED, DRAM_LED, CPU_LED)	1-28
12. USB 3.0 connectors (20-1 pin USB3_12)	1-36
13. AMD® A88X Serial ATA 6 Gb/s connectors (7-pin SATA6G_1-8 [red])	1-35
14. Hard Disk LED (HD_LED)	1-27
15. BIOS Flashback LED (FLBK_LED)	1-29
16. Direct connector (2-pin DRCT)	1-38
17. System panel connector (20-8 pin PANEL)	1-41
18. KeyBot button (KEYBOT)	1-25
19. KeyBot LED (KEYBOT_LED)	1-28
20. USB 2.0 connectors (10-1 pin USB34; USB56; USB78)	1-37
21. Clear CMOS button (CLR_CMOS)	1-25
22. ROG Extension connector (18-1 pin ROG_EXT)	1-42
23. TPM connector (20-1 pin TPM)	1-42
24. Sonic SoundStage button (SOUNDSTAGE)	1-26
25. Front panel audio connector (10-1 pin AAFP)	1-38

1.2.3 Central Processing Unit (CPU)

The motherboard comes with an AMD FM2+ socket designed for AMD® A-series and Athlon™ Series processors.

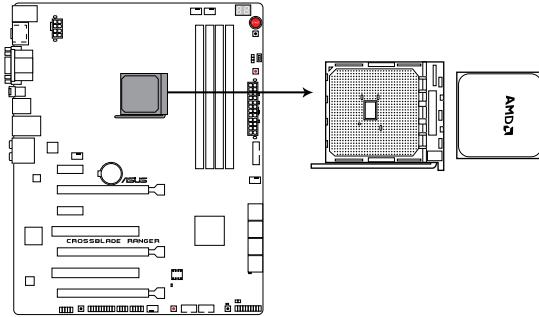

CROSSBLADE RANGER CPU socket FM2+



Ensure that you use a APU designed for the FM2+ socket. The APU fits in only one correct orientation. DO NOT force the APU into the socket to prevent bending the pins and damaging the APU!

1.2.4 System memory

The motherboard comes with four Double Data Rate 3 (DDR3) Dual Inline Memory Modules (DIMM) slots.



A DDR3 module is notched differently from a DDR or DDR2 module. DO NOT install a DDR or DDR2 memory module to the DDR3 slot.

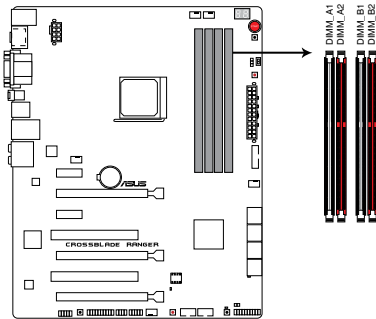

CROSSBLADE RANGER 240-pin DDR3 DIMM sockets

Recommended memory configurations

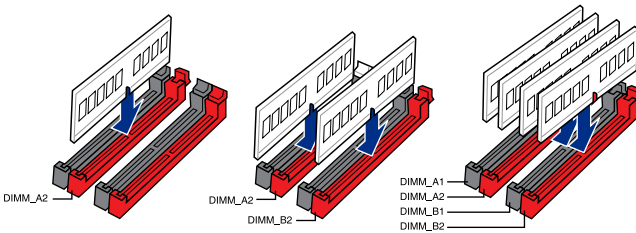

Memory configurations

You may install 1 GB, 2 GB, 4 GB and 8 GB unbuffered and non-ECC DDR3 DIMMs into the DIMM sockets.



-
- You may install varying memory sizes in Channel A and Channel B. The system maps the total size of the lower-sized channel for the dual-channel configuration. Any excess memory from the higher-sized channel is then mapped for single-channel operation.
 - Always install DIMMs with the same CAS latency. For optimal compatibility, we recommend that you install memory modules of the same version or date code (D/C) from the same vendor. Check with the retailer to get the correct memory modules.
 - Due to the memory address limitation on 32-bit Windows OS, when you install 4GB or more memory on the motherboard, the actual usable memory for the OS can be about 3GB or less. For effective use of memory, we recommend that you do any of the following:
 - a) Use a maximum of 3GB system memory if you are using a 32-bit Windows OS.
 - b) Install a 64-bit Windows OS when you want to install 4GB or more on the motherboard.
 - c) For more details, refer to the Microsoft® support site at <http://support.microsoft.com/kb/929605/en-us>.
 - This motherboard does not support DIMMs made up of 512Mb (64MB) chips or less (Memory chip capacity counts in Megabit, 8 Megabit/Mb = 1 Megabyte/MB).
-



-
- The default memory operation frequency is dependent on its Serial Presence Detect (SPD), which is the standard way of accessing information from a memory module. Under the default state, some memory modules for overclocking may operate at a lower frequency than the vendor-marked value. To operate at the vendor-marked or at a higher frequency, refer to section 3.4 **Extreme Tweaker** menu for manual memory frequency adjustment.
 - For system stability, use a more efficient memory cooling system to support a full memory load (4 DIMMs) or overclocking condition.
-

CROSSBLADE RANGER Motherboard Qualified Vendors Lists (QVL)

DDR3 2666 (O.C.) MHz capability

Vendors	Part No.	Size	SS/DS	Chip Brand	Chip NO.	Timing	Voltage	DIMM socket support (optional)		
								1DIMM	2DIMMs	4DIMMs
CORSAIR	CMD16GX3M4A2666C10 (Ver4.13)	4GB	DS	-	-	10-12-12-31	1.65V	.	.	.
G.SKILL	F3-2666C11Q-16GTXD(XMP)	16GB (4x4GB)	DS	-	-	11-13-13-35	1.65V	.	.	.

DDR3 2400 (O.C.) MHz capability

Vendors	Part No.	Size	SS/DS	Chip Brand	Chip NO.	Timing	Voltage	DIMM socket support (optional)		
								1DIMM	2DIMMs	4DIMMs
KINGMAX	FLLE88F-C8KCAA HAIS (XMP)	2GB	SS	-	-	10-11-10-30	1.8V	.	.	.
G.SKILL	F3-2400C10D-8GTX(XMP)	8GB (2x4GB)	SS	-	-	10-12-12-31	1.65V	.	.	.
G.SKILL	F3-19200CL 10Q-32GBZHD (XMP)	8GB	DS	-	-	10-12-12-31	1.65V	.	.	.
CORSAIR	CMGTX8(XMP)	8GB (2GBx 4)	SS	-	-	10-12-10-27	1.65V	.	.	.
CORSAIR	CMD16GX3M2A2400C9 (Ver4.21)	8GB	DS	-	-	10-12-12-31	1.65V	.	.	.
CORSAIR	CMD32GX3M4A2400C10 (Ver5.29)	8GB	DS	-	-	10-12-12-31	1.65V	.	.	.
CORSAIR	CMY16GX3M2A2400C10R (Ver4.21)	8GB	DS	-	-	10-12-12-31	1.65V	.	.	.
GEIL	GET34GB2400C9DC (XMP)	2GB	DS	-	-	9-11-9-27	1.65V	.	.	.
KINGSTON	KHX24C11T2K2/8X (XMP)	4GB	DS	-	-	-	1.65V	.	.	.
ADATA	AX3U2400GW8G11	16GB (2 x 8GB)	DS	-	-	11-13-13-35	1.65V	.	.	.

DDR3 2250 (O.C.) MHz capability

Vendors	Part No.	Size	SS/DS	Chip Brand	Chip NO.	Timing	Voltage	DIMM socket support (optional)		
								1DIMM	2DIMMs	4DIMMs
KINGSTON	KHX2250C9D3T1K2/4GX (XMP)	16GB (2 x 8GB)	DS	-	-	11-13-13-35	1.65V	.	.	.

DDR3 2200 (O.C.) MHz capability

Vendors	Part No.	Size	SS/DS	Chip Brand	Chip NO.	Timing	Voltage	DIMM socket support (optional)		
								1DIMM	2DIMMs	4DIMMs
GEIL	GET34GB2200C9DC (XMP)	2GB	DS	-	-	9-10-9-28	1.65V	.	.	.
GEIL	GET38GB2200C9ADC (XMP)	4GB	DS	-	-	9-11-9-28	1.65V	.	.	.
KINGMAX	FLKE85F-B8KJAA-FEIS (XMP)	2GB	DS	-	-	-	-	.	.	.
KINGMAX	FLKE85F-B8KHA EEIH (XMP)	4GB (2x2GB)	DS	-	-	-	1.5V-1.7V	.	.	.
KINGMAX	FLKE85F-B8KJA FEIH (XMP)	4GB (2x2GB)	DS	-	-	-	1.5V-1.7V	.	.	.

DDR3 2133 MHz capability

Vendors	Part No.	Size	SS/ DS	Chip Brand	Chip NO.	Timing	Voltage	DIMM socket support (optional)		
								1DIMM	2DIMMs	4DIMMs
A-DATA	AX3U2133GC2G9B-DG2 (XMP)	2GB	SS	-	-	9-11-9-27	1.55- 1.75V	.	.	.
CORSAIR	CMT16GX3M4X2133C9 (XMP1.3)	16GB (4GBx4)	DS	-	-	9-11-10-27	1.50V	.	.	.
CORSAIR	CMT4GX3M2A2133C9 (XMP)	4GB (2x2GB)	DS	-	-	9-10-9-24	1.65V	.	.	.
CORSAIR	CMT4GX3M2B2133C9 (XMP)	4GB (2x2GB)	DS	-	-	9-10-9-27	1.50V	.	.	.
CORSAIR	CMT8GX3M2B2133C9 (XMP)	8GB (4GBx2)	DS	-	-	9-11-9-27	1.50V	.	.	.
G.SKILL	F3-17000CL9Q-16GBZH (XMP1.3)	16GB (4GBx4)	DS	-	-	9-11-10-28	1.65V	.	.	.
KINGSTON	KHX2133C11D3T1K2/16GX (XMP)	16GB (8GBx2)	DS	-	-	-	1.6V	.	.	.
KINGSTON	KHX2133C9AD3T1K2/4GX (XMP)	4GB (2x2GB)	DS	-	-	-	1.65V	.	.	.
KINGSTON	KHX2133C9AD3X2K2/4GX (XMP)	4GB (2x2GB)	DS	-	-	9-11-9-27	1.65V	.	.	.
KINGSTON	KHX2133C9AD3T1K4/8GX (XMP)	8GB (4x2GB)	DS	-	-	9-11-9-27	1.65V	.	.	.
KINGSTON	KHX2133C9AD3T1FK4/8GX (XMP)	8GB (4x2GB)	DS	-	-	-	1.65V	.	.	.
PATRIOT	PGD38G2133C11K (XMP)	16GB (4GBx4)	DS	-	-	11-11-11-30	1.65V	.	.	.
Team	TXD34096M2133HC9N-L	4GB	DS	SEC 128 HCH9	K4B2G0846D	9-11-11-28	1.65V	.	.	.
KINGSTON	KHX21C11T1BK2/16X (XMP)	16GB (8GBx2)	DS	-	-	-	1.6V	.	.	.
KINGSTON	KHX21C11T1BK2/8X (XMP)	8GB (4GBx2)	DS	-	-	-	1.6V	.	.	.
Team	TXD34096M2133HC9N-L	4GB	DS	SEC 128 HCH9	K4B2G0846D	9-11-11-28	1.65V	.	.	.
KINGSTON	KHX2133C11D3K4/16GX (XMP)	16GB (4GBx4)	DS	-	-	-	1.65V	.	.	.
ADATA	AX3U2133XC4G10-2X (XMP)	4GB	DS	-	-	10-11-11-30	1.65V	.	.	.
ADATA	AX3U2133XW8G10-2X (XMP)	8GB	DS	-	-	10-11-11-30	1.65V	.	.	.
ADATA	AX3U2133XW8G10	16GB (2x8GB)	DS	-	-	10-11-11-30	1.65V	.	.	.
Team	TLD38G2133HC11ABK	8GB	DS	-	-	11-11-11-31	1.65V	.	.	.
G.SKILL	F3-2133C11Q-32GZL (XMP)	8GB	DS	-	-	11-11-11-31	1.5V	.	.	.
KINGSTON	KHX21C11T3K4/32X	8GB	DS	-	-	-	1.65V	.	.	.

DDR3 1866 MHz capability

Vendor	Part No.	Size	SS/ DS	Chip Brand	Chip NO.	Timing	Voltage	DIMM socket support (optional)		
								1DIMM	2DIMMs	4DIMMs
CORSAIR	CMT4GX3M2A1866C9 (XMP)	4GB (2x2GB)	DS	-	-	9-9-9-24	1.65V	.	.	.
CORSAIR	CMT6GX3MA1866C9 (XMP)	6GB (3x2GB)	DS	-	-	9-9-9-24	1.65V	.	.	.
CORSAIR	CMZ8GX3M2A1866C9 (XMP)	8GB (2x4GB)	DS	-	-	9-10-9-27	1.50V	.	.	.
G.SKILL	F3-14900CL9Q-16GBZL (XMP1.3)	16GB (4GBx4)	DS	-	-	9-10-9-28	1.5V	.	.	.
G.SKILL	F3-14900CL10Q2-64GBZLD (XMP1.3)	64GB (8GBx8)	DS	-	-	10-11-10-30	1.5V	.	.	.
G.SKILL	F3-14900CL9D-8GBXL (XMP)	8GB (2x4GB)	DS	-	-	9-10-9-28	1.5V	.	.	.
G.SKILL	F3-14900CL9Q-8GBXL (XMP)	8GB (2GBx4)	DS	-	-	9-9-9-24	1.6V	.	.	.
KINGSTON	KHX1866C9D3K4/16GX (XMP)	16GB (4GBx4)	DS	-	-	-	1.65V	.	.	.
KINGSTON	KHX1866C9D3T1K3/6GX (XMP)	6GB (3x2GB)	DS	-	-	-	1.65V	.	.	.
KINGSTON	KHX1866C11D3P1K2/8G	8GB (4GBx2)	DS	-	-	-	1.5V	.	.	.
KINGSTON	KHX1866C9D3K2/8GX (XMP)	8GB (4GBx2)	DS	-	-	-	1.65V	.	.	.
CRUCIAL	BLE4G3D1869DE1TX0.16FMD (XMP)	4GB	DS	-	-	9-9-9-27	1.5V	.	.	.
CRUCIAL	BLT4G3D1869DT2TXOB.16FMR (XMP)	4GB	DS	-	-	9-9-9-27	1.5V	.	.	.
AMD	AP38G1869U2K	8GB (4GBx2)	DS	-	-	9-10-9-27	1.5V	.	.	.
ADATA	AX3U1866XW8G10	16GB (2x8GB)	DS	-	-	10-11-10-30	1.5V	.	.	.
PATRIOT	PV138G186C9KPD0000326	4GB	DS	-	-	-	1.5V	.	.	.
Team	TLD34G1866H9KBK	4GB	DS	-	-	9-11-9-27	1.5V	.	.	.
Team	TLD38G1866HC10SBK	8GB	DS	-	-	10-11-10-30	1.5V	.	.	.
CRUCIAL	BLT4G3D1869DT1TX0.13FKD (XMP)	4GB	DS	-	-	9-9-9-27	1.5V	.	.	.
KINGSTON	KHX18C10T3K4/32X	8GB	DS	-	-	-	1.5V	.	.	.

DDR3 1600 MHz capability

Vendor	Part No.	Size	SS/ DS	Chip Brand	Chip NO.	Timing	Voltage	DIMM socket support (optional)		
								1DIMM	2DIMMs	4DIMMs
A-DATA	AM2U16BC2P1	2GB	SS	A-DATA	3CCD-1509A EL1126T	-	-	.	.	.
A-DATA	AX3U1600XB2G79-2X (XMP)	4GB (2x2GB)	DS	-	-	7-9-7-21	1.55V-1.75V	.	.	.
A-DATA	AM2U16BC4P2	4GB	DS	A-DATA	3CCD-1509A EL1126T	-	-	.	.	.
A-DATA	AX3U1600GC4G9-2G (XMP)	8GB (2x4GB)	DS	-	-	9-9-9-24	1.55V-1.75V	.	.	.
A-DATA	AX3U1600XC4G79-2X (XMP)	8GB (2x4GB)	DS	-	-	7-9-7-21	1.55V-1.75V	.	.	.
CORSAIR	TR3X3G1600C8D (XMP)	3GB (3x1GB)	SS	-	-	8-8-8-24	1.65V	.	.	.
CORSAIR	CMD12GX3M6A1600C8 (XMP)	12GB (6x2GB)	DS	-	-	8-8-8-24	1.65V	.	.	.
CORSAIR	CMZ32GX3M4X1600C10 (XMP)	32GB (8GBx4)	DS	-	-	10-10-10- 27	1.50V	.	.	.
CORSAIR	CMP4GX3M2A1600C8 (XMP)	4GB (2x2GB)	DS	-	-	8-8-8-24	1.65V	.	.	.
CORSAIR	CMP4GX3M2A1600C9 (XMP)	4GB (2x2GB)	DS	-	-	9-9-9-24	1.65V	.	.	.
CORSAIR	CMP4GX3M2C1600C7 (XMP)	4GB (2x2GB)	DS	-	-	7-8-7-20	1.65V	.	.	.
CORSAIR	CMX4GX3M2A1600C9 (XMP)	4GB (2x2GB)	DS	-	-	9-9-9-24	1.65V	.	.	.
CORSAIR	CMX4GX3M2A1600C9 (XMP)	4GB (2x2GB)	DS	-	-	9-9-9-24	1.65V	.	.	.
CORSAIR	TR3X6G1600C8 G (XMP)	6GB (3x2GB)	DS	-	-	8-8-8-24	1.65V	.	.	.
CORSAIR	TR3X6G1600C8D G (XMP)	6GB (3x2GB)	DS	-	-	8-8-8-24	1.65V	.	.	.
CORSAIR	TR3X6G1600C9 G (XMP)	6GB (3x2GB)	DS	-	-	9-9-9-24	1.65V	.	.	.
CORSAIR	CMP8GX3M2A1600C9 (XMP)	8GB (2x4GB)	DS	-	-	9-9-9-24	1.65V	.	.	.
CORSAIR	CMZ8GX3M2A1600C7R (XMP)	8GB (2x4GB)	DS	-	-	7-8-7-20	1.50V	.	.	.
CORSAIR	CMX8GX3M4A1600C9 (XMP)	8GB (4x2GB)	DS	-	-	9-9-9-24	1.65V	.	.	.
Crucial	BL25664BN1608.16FF (XMP)	6GB (3x2GB)	DS	-	-	-	-	.	.	.
G.SKILL	F3-12800CL9D-2GBNQ (XMP)	2GB (2x1GB)	SS	-	-	9-9-9-24	1.5V	.	.	.
G.SKILL	F3-12800CL7D-4GBRH (XMP)	4GB (2x2GB)	SS	-	-	7-7-7-24	1.6V	.	.	.
G.SKILL	F3-12800CL7D-4GBECO (XMP)	4GB (2x2GB)	DS	-	-	7-7-8-24	XMP 1.35V	.	.	.
G.SKILL	F3-12800CL7D-4GBRM (XMP)	4GB (2x2GB)	DS	-	-	7-8-7-24	1.6V	.	.	.
G.SKILL	F3-12800CL8D-4GBRM (XMP)	4GB (2x2GB)	DS	-	-	8-8-8-24	1.60V	.	.	.
G.SKILL	F3-12800CL9D-4GBECO (XMP)	4GB (2x2GB)	DS	-	-	9-9-9-24	XMP 1.35V	.	.	.
G.SKILL	F3-12800CL9D-4GBRL (XMP)	4GB (2x2GB)	DS	-	-	9-9-9-24	1.5V	.	.	.
G.SKILL	F3-12800CL9T-6GBNQ (XMP)	6GB (3x2GB)	DS	-	-	9-9-9-24	1.5V -1.6V	.	.	.
G.SKILL	F3-12800CL7D-8GBRH (XMP)	8GB (2x4GB)	DS	-	-	7-8-7-24	1.6V	.	.	.
G.SKILL	F3-12800CL8D-8GBECO (XMP)	8GB (2x4GB)	DS	-	-	8-8-8-24	XMP 1.35V	.	.	.
G.SKILL	F3-12800CL9D-8GBRL (XMP)	8GB (2x4GB)	DS	-	-	9-9-9-24	1.5V	.	.	.
GEIL	GET316GB1600C9QC (XMP)	16GB (4x4GB)	DS	-	-	9-9-9-28	1.6V	.	.	.
GEIL	GV34GB1600C8DC(XMP)	2GB	DS	-	-	8-8-8-28	1.6V	.	.	.
HYNIX	HMT351U6CFR8C-PB	4GB	DS	HYNIX	H5TQ2G83CFR PBC	-	-	.	.	.
KINGMAX	F L G D 4 5 F - B 8 M F 7 MAEH(XMP)	1GB	SS	-	-	7	-	.	.	.

(continued on the next page)

DDR3 1600 MHz capability

Vendor	Part No.	Size	SS/ DS	Chip brand Chip NO.		Timing	Voltage	DIMM socket support (optional)		
								1DIMM	2DIMMs	4DIMMs
KINGMAX	FLGE85F-B8KJ9A FEIS(XMP)	2GB	DS	-	-	-	-	.	.	.
KINGMAX	FLGE85F-B8MF7 MEEH(XMP)	2GB	DS	-	-	7	-	.	.	.
KINGSTON	KHX1600C9D3P1K2/4G	4GB (2x2GB)	SS	-	-	-	1.5V	.	.	.
KINGSTON	KHX1600C9D3K3/12GX (XMP)	12GB (3x4GB)	DS	-	-	9-9-9-27	1.65V	.	.	.
KINGSTON	KHX1600C9D3T1BK3/12GX (XMP)	12GB (3x4GB)	DS	-	-	9-9-9-27	1.65V	.	.	.
KINGSTON	KHX1600C9D3K4/16GX (XMP)	16GB (4GBx4)	DS	-	-	-	1.65V	.	.	.
KINGSTON	KHX1600C9AD3/2G	2GB	DS	-	-	-	1.65V	.	.	.
KINGSTON	KVR1600D3N11/2G-ES	2GB	DS	KTC	D1288JNPDL9U	11-11-11-28	1.35V -1.5V	.	.	.
KINGSTON	KHX1600C7D3K2/4GX (XMP)	4GB (2x2GB)	DS	-	-	-	1.65V	.	.	.
KINGSTON	KHX1600C8D3K2/4GX (XMP)	4GB (2x2GB)	DS	-	-	8	1.65V	.	.	.
KINGSTON	KHX1600C8D3T1K2/4GX (XMP)	4GB (2x2GB)	DS	-	-	8	1.65V	.	.	.
KINGSTON	KHX1600C9D3K2/4GX (XMP)	4GB (2x2GB)	DS	-	-	9	1.65V	.	.	.
KINGSTON	KHX1600C9D3L2/4GX (XMP)	4GB (2x2GB)	DS	-	-	9	XMP 1.35V	.	.	.
KINGSTON	KHX1600C9D3X2K2/4GX (XMP)	4GB (2x2GB)	DS	-	-	9-9-9-27	1.65V	.	.	.
KINGSTON	KHX1600C9D3T1K3/6GX (XMP)	6GB (3x2GB)	DS	-	-	-	1.65V	.	.	.
KINGSTON	KHX1600C9D3K3/6GX (XMP)	6GB (3x2GB)	DS	-	-	9	1.65V	.	.	.
KINGSTON	KHX1600C9D3T1BK3/6GX (XMP)	6GB (3x2GB)	DS	-	-	9-9-9-27	1.65V	.	.	.
KINGSTON	KHX1600C9D3K2/8GX (XMP)	8GB (2x4GB)	DS	-	-	9-9-9-27	1.65V	.	.	.
KINGSTON	KHX1600C9D3P1K2/8G	8GB (2x4GB)	DS	-	-	-	1.5V	.	.	.
Super Talent	WA160UX6G9	6GB (3x2GB)	DS	-	-	9	-	.	.	.
Transcend	JM1600KLN-8GK	8GB (4GBx2)	DS	Transcend	TK483PCW3	-	-	.	.	.
SanMax	SMD-4G68HP-16KZ	4GB	DS	HYNIX	H5TQ2G83BFR PBC	-	-	.	.	.
AMD	AE32G1609U1-U	2GB	SS	-	23EY4587MB6H11503M	9-9-9-24	1.5V	.	.	.
AMD	AE34G1609U2-U	4GB	DS	AMD	23EY4587MB6H11503M	9-9-9-24	1.5V	.	.	.
ASint	SLZ302G08-EGN1C	2GB	SS	Asint	SLZ302G08-GN1C	-	-	.	.	.
Asint	SLZ3128M8-EGJ1D (XMP)	2GB	DS	Asint	3128M8-GJ1D	9-9-9-24	1.6V	.	.	.
Asint	SLA302G08-EGG1C (XMP)	4GB	DS	Asint	302G08-GG1C	-	-	.	.	.
Asint	SLA302G08-EGJ1C (XMP)	4GB	DS	Asint	302G08-GJ1C	-	-	.	.	.
ASint	SLA302G08-EGN1C	4GB	DS	Asint	SLA302G08-GN1C	-	-	.	.	.
ASint	SLB304G08-EGN1B	8GB	DS	Asint	SLB304G08-GN1B	-	-	.	.	.
Elixir	M2P2G64CB8HC9N-DG (XMP)	2GB	DS	-	-	-	-	.	.	.
Elixir	M2X8G64CB8HB5N-DG (XMP)	8GB	DS	Elixir1213	N2CB4G8BOBN-DG	-	-	.	.	.
Mushkin	998659 (XMP)	6GB (3x2GB)	DS	-	-	9-9-9-24	-	.	.	.
Mushkin	998659 (XMP)	6GB (3x2GB)	DS	-	-	9-9-9-24	1.5 -1.6V	.	.	.
PATRIOT	PGD316G1600ELK (XMP)	32GB (8GBx4)	DS	-	-	9-9-9-24	1.65V	.	.	.
PATRIOT	PGS34G1600LLKA	4GB (2x2GB)	DS	-	-	7-7-7-20	1.7V	.	.	.

(continued on the next page)

DDR3 1600 MHz capability

Vendor	Part No.	Size	SS/DS	Chip Brand	Chip No.	Timing	Voltage	DIMM socket support (optional)		
								1DIMM	2DIMMs	4DIMMs
Silicon Power	SP002GBLTU160V02 (XMP)	2GB	SS	S-POWER	20YT5NG-1201	-	-	.	.	.
Silicon Power	SP004GBLTU160V02 (XMP)	4GB	DS	S-POWER	20YT5NG-1201	-	-	.	.	.
Apacer	78.B1GE3.9L10C	4GB	DS	Apacer KZCC	AM5D5908DEQSCCK	-	-	.	.	.
KINGSTON	KHX16C9K2/16	16GB (8GBx2)	DS	-	-	-	1.5V	.	.	.
Elixir	M2X8G64CB8HBSN-DG (XMP)	8GB	DS	Elixir 1213	N2CB4G8BOBN-DG	-	-	.	.	.
APACER	8GB UNB PC3-12800 CL11	8GB	DS	APACER	AM5D6008BQQSCCK	-	-	.	.	.
CORSAIR	CMZ8GX3M1A1600C10 (XMP)	8GB	DS	-	-	10-10 -10-27	1.50V	.	.	.
Transcend	8G DDR31600 DIMM CL11	8GB	DS	SEC 222 HYKO	6MD9639W	-	-	.	.	.
Transcend	8G DDR31600 DIMM CL11	8GB	DS	Transcend	E223X8B0648S	-	-	.	.	.
ADATA	AD3U1600C2G11-B	2GB	SS	-	N/A	-	-	.	.	.
ADATA	AD3U1600W4G11-B	4GB	SS	ADATA	F209X8BR6413	-	-	.	.	.
ADATA	AD3U1600C4G11-B	4GB	DS	-	N/A	-	-	.	.	.
ADATA	AD3U1600W8G11-B	8GB	DS	ADATA	F211X8B0640A	-	-	.	.	.
TEAM	TED34G1600HC11BK	4GB	DS	-	-	11-11 -11-28	-	.	.	.
TEAM	TLD34G1600HC9BK (XMP)	4GB	DS	-	-	9-9-24	1.5V	.	.	.
MICRON	MT8JTF51264AZ-1G6E1	4GB	SS	MICRON	D9QBJ	-	-	.	.	.
MICRON	MT16JTF1G64AZ-1G6E1	8GB	DS	MICRON	D9QBJ	-	-	.	.	.
Transcend	TS512MLK64W6H	4GB	SS	SEC 234 HYKO	K4B4GO8468	-	-	.	.	.
Transcend	TS1GLK64W6H	8GB	DS	SEC 234 HYKO	K4B4GO8468	-	-	.	.	.
ADATA	AX3U1600GW8G9	16GB (2x8GB)	DS	-	-	9-9-9-24	1.5V	.	.	.
ADATA	AXDU1600GW8G9B	16GB (2x8GB)	DS	-	-	11-11 -11-28	1.5V	.	.	.
Asint	SLA304G08-ENG1B	4GB	SS	Asint	304G08-1N1301	-	-	.	.	.
Asint	SLB304G08-EGJ1B	8GB	DS	-	-	-	-	.	.	.
PATRIOT	PV332G160C9QK	8GB	DS	-	-	-	1.5V	.	.	.
APACER	4GB UNB PC3-12800 CL11	4GB	SS	APACER	AM5D6008BQQSCCK	-	-	.	.	.
G.SKILL	F3-12800CL10S-8GBXL (XMP)	8GB	DS	-	-	10-10 -10-30	-	.	.	.
KINGSTON	KVR16N11/4 (Low Profile)	4GB	DS	KINGSTON	D2568GEROPGGBU	-	1.5V	.	.	.
KINGSTON	KHX16C10B1K2/16X (XMP)	8GB	DS	-	-	-	1.5V	.	.	.
KINGSTON	KHX16C9P1K2/16 (XMP)	8GB	DS	-	-	-	1.5V	.	.	.
PSC	AL9F8L93B-GN2E	4GB	SS	PSC	XHP284C3G-M	-	-	.	.	.
PSC	ALAF8L93B-GN2E	8GB	DS	PSC	XHR425C3G-M	-	-	.	.	.
Elixir	M2P2G64CB8HC9N-DG	2GB	DS	-	-	-	-	.	.	.

DDR3 1333 MHz capability

Vendor	Part No.	Size	SS/DS	Chip Brand	Chip No.	Timing	Voltage	DIMM socket support (optional)		
								1DIMM	2DIMMs	4DIMMs
A-DATA	AD31333001GOU	1GB	SS	A-Data	AD30908C8D-151C E0906	-	-	.	.	.
A-DATA	AD3U1333C2G9	2GB	SS	A-DATA	3CCD-1509HNA1126L	-	-	.	.	.
A-DATA	AM2U139C2P1	2GB	SS	ADATA	3CCD-1509A EL1127T	-	-	.	.	.
A-DATA	AX3U1333C2G9-BP	2GB	SS	-	-	-	-	.	.	.
A-DATA	AD31333G001GOU	3GB (3x1GB)	SS	-	-	8-8-8-24	1.65-1.85V	.	.	.

(continued on the next page)

DDR3 1333 MHz capability

Vendor	Part No.	Size	SS/ DS	Chip Brand	Chip No.	Timing	Voltage	DIMM socket support (optional)		
								1DIMM	2DIMMs	4DIMMs
A-DATA	AXDU1333GC2G9-2G (XMP)	4GB (2x2GB)	SS	-	-	9-9-9-24	1.25V-1.35V (low voltage)	•	•	
A-DATA	AD31333G002GMU	2GB	DS	-	-	8-8-8-24	1.65-1.85V	•		
A-DATA	AD6311C1624EV	4GB	DS	A-Data	3CCA-1509A	-	-	•	•	•
A-DATA	AM2U139C4P2	4GB	DS	ADATA	3CCD-1509A EL1127T	-	-	•	•	•
A-DATA	SU3U1333W8G9-B	8GB	DS	ELPIDA	J4208BASE-DJ-F	-	-	•	•	•
Apacer	78.A1GC6.9L1	2GB	DS	Apacer	AM5D5808DEWSBG	-	-	•	•	•
Apacer	78.A1GC6.9L1	2GB	DS	Apacer	AM5D5808FEQSBG	9	-	•	•	•
Apacer	AU02GFA33C9NBNCG	2GB	DS	Apacer	AM5D5808APOSBG	-	-	•	•	•
Apacer	78.B1GDE.9L10C	4GB	DS	Apacer	AM5D5908CEHSBG	-	-	•	•	•
Corsair	TR3X3G1333C9 G	3GB (3x1GB)	SS	-	-	9-9-9-24	1.50V	•	•	•
Corsair	TR3X6G1333C9 G	6GB (3x2GB)	SS	-	-	9-9-9-24	1.50V	•	•	•
Corsair	CMD24GX3M6A1333C9 (XMP)	24GB (6x4GB)	DS	-	-	9-9-9-24	1.60V	•	•	•
Corsair	TW3X4G1333C9D G	4GB (2x2GB)	DS	-	-	9-9-9-24	1.50V	•	•	•
Corsair	CM3X4GA1333C9N2	4GB	DS	Corsair	256MBDCJGELC0401136	9-9-9-24	-	•	•	•
Corsair	CMX4GX3M1A1333C9	4GB	DS	-	-	9-9-9-24	1.50V	•	•	•
Corsair	CMD8GX3M4A1333C7	8GB (4x2GB)	DS	-	-	7-7-7-20	1.60V	•	•	•
Crucial	CT12864BA1339.8FF	1GB	SS	Micron	9FF22D9KPT	9	-	•	•	•
Crucial	CT25664BA1339.16FF	2GB	DS	Micron	9KF27D9KPT	9	-	•	•	•
Crucial	BL25664BN1337.16FF (XMP)	6GB (3x2GB)	DS	-	-	7-7-7-24	1.65V	•	•	•
Elpida	EBJ10UE8EDF0-DJ-F	1GB	SS	ELPIDA	J1108EDSE-DJ-F	-	1.35V (low voltage)	•	•	•
Elpida	EBJ21UE8EDF0-DJ-F	2GB	DS	ELPIDA	J1108EDSE-DJ-F	-	1.35V (low voltage)	•	•	•
G-Skill	F3-10600CL8D-2GBHK (XMP)	1GB	SS	G.SKILL	-	-	-	•	•	•
G-Skill	F3-10600CL9D-2GBNQ	2GB (2x1GB)	SS	-	-	9-9-9-24	1.5V	•	•	•
G-Skill	F3-10666CL8D-4GBECO (XMP)	4GB (2x2GB)	DS	-	-	8-8-8-24	XMP 1.35V	•	•	•
G-Skill	F3-10666CL7D-8GBRH (XMP)	8GB (2x4GB)	DS	-	-	7-7-7-21	1.5V	•	•	•
GEIL	GV32GB1333C9DC	2GB (2x1GB)	DS	-	-	9-9-9-24	1.5V	•	•	•
GEIL	GG34GB1333C9DC	4GB (2x2GB)	DS	GEIL	GL1L128M88BA12N	9-9-9-24	1.3V (low voltage)	•	•	•
GEIL	GV34GB1333C9DC	4GB (2x2GB)	DS	-	-	9-9-9-24	1.5V	•	•	•
GEIL	GVP34GB1333C7DC	4GB (2x2GB)	DS	-	-	7-7-7-24	1.5V	•	•	•
Hynix	HMT112U6TFR8A-H9	1GB	SS	Hynix	H5TC1G83TFRH9A	-	1.35V (low voltage)	•	•	•
Hynix	HMT325U6BFR8C-H9	2GB	SS	Hynix	H5TQ2G83BFRH9C	-	-	•	•	•
Hynix	HMT125U6TFR8A-H9	2GB	DS	Hynix	H5TC1G83TFRH9A	-	1.35V (low voltage)	•	•	•
Hynix	HMT351U6BFR8C-H9	4GB	DS	Hynix	H5TQ2G83BFRH9C	-	-	•	•	•
Kingmax	FLFD45F-B8KL9 NAES	1GB	SS	Kingmax	KKB8FNWBFGNX-27A	-	-	•	•	•
Kingmax	FLFE85F-C8KF9 CAES	2GB	SS	Kingmax	KFC8FMFXF-DXX-15A	-	-	•	•	•
Kingmax	FLFE85F-C8KL9 NAES	2GB	SS	Kingmax	KFC8FNLXF-DXX-15A	-	-	•	•	•
Kingmax	FLFE85F-C8KM9 NAES	2GB	SS	Kingmax	KFC8FNMXF-BXX-15A	-	-	•	•	•
Kingmax	FLFE85F-B8KL9 NEES	2GB	DS	Kingmax	KKB8FNWBFGNX-26A	-	-	•	•	•
Kingmax	FLFF65F-C8KL9 NEES	4GB	DS	Kingmax	KFC8FNLXF-DXX-15A	-	-	•	•	•
Kingmax	FLFF65F-C8KM9 NEES	4GB	DS	Kingmax	KFC8FNMXF-BXX-15A	-	-	•	•	•

(continued on the next page)

DDR3 1333 MHz capability

Vendor	Part No.	Size	SS/DS	Chip Brand	Chip NO.	Timing	Voltage	DIMM socket support (optional)		
								1DIMM	2DIMMs	4DIMMs
KINGSTON	KVR1333D3N9/1G (Low Profile)	1GB	SS	ELPIDA	J1108BDBG-DJ-F	9	1.5V	.	.	.
KINGSTON	KVR1333D3N9/2G (Low Profile)	2GB	SS	Hynix	H5TQ2G83AFRH9C	9	-	.	.	.
KINGSTON	KVR1333D3S8N9/2G	2GB	SS	Micron	IID77 D9L GK	-	1.5V	.	.	.
KINGSTON	KVR1333D3S8N9/2G-SP (Low Profile)	2GB	SS	ELPIDA	J2108BCSE-DJ-F	-	1.5V	.	.	.
KINGSTON	KVR1333D3N9/2G (Low Profile)	2GB	DS	ELPIDA	J1108BFBG-DJ-F	9	1.5V	.	.	.
KINGSTON	KVR1333D3N9/2G	2GB	DS	KTC	D1288JPNDPLD9U	9	1.5V	.	.	.
KINGSTON	KVR1333D3N9/2G	2GB	DS	ELPIDA	J1108BDSE-DJ-F	9	1.5V	.	.	.
KINGSTON	KVR1333D3N9/2G-SP (Low Profile)	2GB	DS	KTC	D1288JEMFNGD9U	-	1.5V	.	.	.
KINGSTON	KVR1333D3N9/2G-SP (Low Profile)	2GB	DS	KINGSTON	D1288JPSFPGD9U	-	1.5V	.	.	.
KINGSTON	KHX1333C7D3K2/4GX (XMP)	4GB (2x2GB)	DS	-	-	7	1.65V	.	.	.
KINGSTON	KHX1333C9D3UK2/4GX (XMP)	4GB (2x2GB)	DS	-	-	9	XMP 1.25V	.	.	.
KINGSTON	KVR1333D3N9/4G (Low Profile)	4GB	DS	ELPIDA	J2108BCSE-DJ-F	9	1.5V	.	.	.
KINGSTON	KVR1333D3N9/4G (Low Profile)	4GB	DS	ELPIDA	J2108BCSE-DJ-F	-	1.5V	.	.	.
KINGSTON	KVR1333D3N9/4G	4GB	DS	KTC	D2568JENCNGD9U	-	1.5V	.	.	.
KINGSTON	KVR1333D3N9/4G	4GB	DS	Hynix	H5TQ2G83AFR	-	-	.	.	.
KINGSTON	KVR1333D3N9/4G-SP (Low Profile)	4GB	DS	KINGSTON	D2568JENCPGD9U	-	1.5V	.	.	.
Micron	MT4JTF12864AZ-1G4D1	1GB	SS	Micron	OJD12D9L GK	-	-	.	.	.
Micron	MT8JTF12864AZ-1G4F1	1GB	SS	Micron	9FF27D9KPT	9	-	.	.	.
Micron	MT8JTF25664AZ-1G4D1	2GB	SS	Micron	OJD12D9L GK	-	-	.	.	.
Micron	MT8JTF25664AZ-1G4M1	2GB	SS	MICRON	IJM22 D9PFJ	-	-	.	.	.
Micron	MT16JTF25664AZ-1G4F1	2GB	DS	Micron	9KF27D9KPT	9	-	.	.	.
Micron	MT16JTF51264AZ-1G4D1	4GB	DS	Micron	OLD22D9L GK	-	-	.	.	.
NANYA	NT4GC64B8HG0NF-CG	4GB	DS	NANYA	NT5CB256M8GN-CG	-	-	.	.	.
PSC	AL7F8G73F-DJ2	1GB	SS	PSC	A3P1GF3FGF	-	-	.	.	.
PSC	AL8F8G73F-DJ2	2GB	DS	PSC	A3P1GF3FGF	-	-	.	.	.
SAMSUNG	M378B2873FHS-CH9	1GB	SS	SAMSUNG	K4B1G0846F	-	-	.	.	.
SAMSUNG	M378B5773DHO-CH9	2GB	SS	SAMSUNG	K4B2G0846D	-	-	.	.	.
SAMSUNG	M378B5673FHO-CH9	2GB	DS	SAMSUNG	K4B1G0846F	-	-	.	.	.
SAMSUNG	M378B5273CHO-CH9	4GB	DS	SAMSUNG	K4B2G0846C	-	-	.	.	.
Super Talent	W1333UA1GH	1GB	SS	Hynix	H5TQ1G83TFR	9	-	.	.	.
Super Talent	W1333UX2G8(XMP)	2GB (2x1GB)	SS	-	-	8	-	.	.	.
Super Talent	W1333UB2GS	2GB	DS	SAMSUNG	K4B1G0846F	9	-	.	.	.
Super Talent	W1333UB4GS	4GB	DS	SAMSUNG	K4B2G0846C	-	-	.	.	.
Super Talent	W1333UX6GM	6GB (3x2GB)	DS	Micron	0BF27D9KPT	9-9-9-24	1.5V	.	.	.
Transcend	JM1333KLN-2G	2GB	SS	Hynix	H5TQ2G83BZRH9C	-	-	.	.	.
Transcend	TS256MLK64V3U	2GB	DS	Micron	9GF27D9KPT	-	-	.	.	.
Transcend	TS1GLK64V3H	8GB	DS	Micron	IVD22D9PBC	-	-	.	.	.
KINGSTEK	KSTD3PC-10600	2GB	SS	MICRON	PE911-125E	-	-	.	.	.
AMD	AE32G1339U1-U	2GB	SS	AMD	23EY4587MB3H11503M	9-9-9-24	1.5V	.	.	.
AMD	AE34G1339U2-U	4GB	DS	AMD	23EY4587MB3H11503M	9-9-9-24	1.5V	.	.	.
ASint	SLZ302G08-EDJ1C	2GB	SS	Asint	SLZ302G08-DJ1C	-	-	.	.	.

(continued on the next page)

DDR3 1333 MHz capability

Vendor	Part No.	Size	SS/ DS	Chip Brand	Chip NO.	Timing	Voltage	DIMM socket support (optional)		
								1DIMM	2DIMMs	4DIMMs
ASint	SLA302G08-EDJ1C	4GB	DS	Asint	SLA302G08-DJ1C	-	-	.	.	.
ASint	SLB304G08-EDJ1B	8GB	DS	Asint	SLB304G08-DJ1B	-	-	.	.	.
Elixir	M2F2G64CB88B7N-CG	2GB	SS	Elixir	N2CB2G80BN-CG	-	-	.	.	.
Elixir	M2F2G64CB88D7N-CG	2GB	SS	Elixir	N2CB2G80DN-CG	-	-	.	.	.
Elixir	M2F2G64CB88G7N-CG	2GB	SS	Elixir	N2CB2G80GN-CG	-	-	.	.	.
Elixir	M2F4G64CB88B5N-CG	4GB	DS	Elixir	N2CB2G80BN-CG	-	-	.	.	.
Elixir	M2F4G64CB88D5N-CG	4GB	DS	Elixir	N2CB2G80DN-CG	-	-	.	.	.
Kingshare	KSRPCD313332G	2GB	DS	PATRIOT	PM128M8D385-15	-	-	.	.	.
Kingtiger	2GB DIMM PC3-10666	2GB	DS	SAMSUNG	SEC 904 HCH9 K4B1G0846D	-	-	.	.	.
Kingtiger	KTG2G1333PG3	2GB	DS	-	-	-	-	.	.	.
Markvision	BMD32048M1333C9-1123	2GB	DS	Markvision	M3D1288P-13	-	-	.	.	.
Markvision	BMD34096M1333C9-1124	4GB	DS	Markvision	M3D2568E-13	-	-	.	.	.
PATRIOT	PSD32G13332H	2GB	DS	-	-	-	-	.	.	.
PATRIOT	PG38G1333EL(XMP)	8GB	DS	-	-	9-9-9-24	1.5V	.	.	.
RAMAXEL	RMR1870ED48E8F-1333	2GB	DS	ELPIDA	J1108BDBG-DJ-F	-	-	.	.	.
RAMAXEL	RMR1870EC58E9F-1333	4GB	DS	ELPIDA	J2108BCSE-DJ-F	-	-	.	.	.
RIDATA	C304627CB1AG22Fe	2GB	DS	RIDATA	N/A	9	-	.	.	.
RIDATA	E304459CB1AG32Cf	4GB	DS	RIDATA	N/A	9	-	.	.	.
Silicon Power	SP002GBLTU133V02	2GB	SS	S-POWER	20YT3NG-1202	-	-	.	.	.
Silicon Power	SP002GBLTU133S02	2GB	DS	Elixir	N2CB1680AN-C6	-	-	.	.	.
Silicon Power	SP004GBLTU133V02	4GB	DS	S-POWER	20YT3NG-1201	-	-	.	.	.
TAKEMS	TMS2GB364D081-107EY	2GB	DS	-	-	7-7-7-20	1.5V	.	.	.
TAKEMS	TMS2GB364D082-138EW	2GB	DS	-	-	8-8-8-24	1.5V	.	.	.
UMAX	E41302GP0-73BDB	2GB	DS	UMAX	U2S24D30TP-13	-	-	.	.	.
WINTEC	3WVS31333-2G-CNR	2GB	DS	AMPO	AM3420803-13H	-	-	.	.	.
Transcend	8G DDR3 1333 DIMM CL9	8GB	DS	Transcend	E207X8B0643Y	-	-	.	.	.
Transcend	8G DDR3 1333 DIMM CL9	8GB	DS	-	N/A	-	-	.	.	.
HMD	HMDD302GU648S1B9C-MEX	2GB	SS	ERTH	256X8DDR3 WT	-	1.5V	.	.	.
HMD	HMDD304GU648S1B9C-MEX	4GB	SS	UUJK	512X8DDR3 WT	-	1.5V	.	.	.
HMD	HMDD308GU648D1B9C-MEX	8GB	DS	FFCT	512X8DDR3 WT	-	1.5V	.	.	.
TEAM	TED34G1333HC9BK	4GB	DS	-	-	9-9-9-24	-	.	.	.
TEAM	TED38G1333HC9BK	8GB	DS	-	-	9-9-9-24	1.5V	.	.	.
Asint	SLA304G08-EDJ1B	4GB	SS	Asint	304G08-DJ1B1301	-	-	.	.	.



Side(s): SS - Single-sided DS - Double-sided

DIMM support:

- **1 DIMM:** Supports one (1) module inserted into any slot as Single-channel memory configuration. **We suggest that you install the module into A2 slot.**
 - **2 DIMMs:** Supports two (2) modules inserted into either the red slots or the black slots as one pair of Dual-channel memory configuration. **We suggest that you install the modules into slots A2 and B2 for better compatibility.**
 - **4 DIMMs:** Supports four (4) modules inserted into both the red and black slots as two pairs of Dual-channel memory configuration.
-



Visit the ASUS website for the latest QVL.

1.2.5 Expansion slots



Unplug the power cord before adding or removing expansion cards. Failure to do so may cause you physical injury and damage motherboard components.

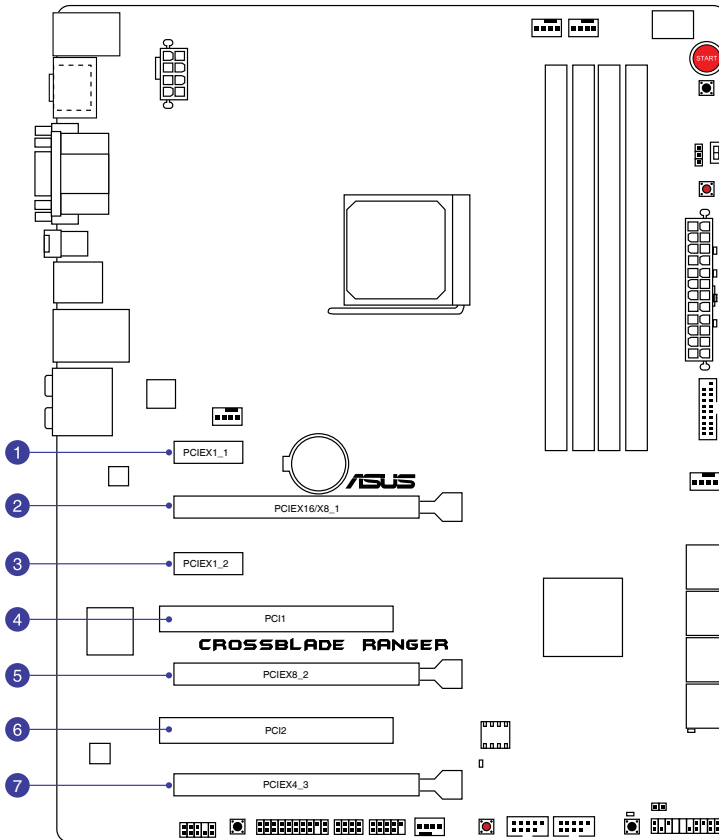

Slot No.	Slot Description
1	PCIe 2.0 x1_1 slot
2	PCIe 3.0/2.0 x16/x8_1 slot
3	PCIe 2.0 x1_2 slot
4	PCI slot 1
5	PCIe 3.0/2.0 x8_2 slot
6	PCI slot 2
7	PCIe 2.0 x4_3 slot

VGA Configuration	PCIe operating mode		
	Single VGA	CrossFireX™	3-WAY CrossFireX™
PCIEX16/X8_1	x16	x16	x8
PCIEX8_2	–	–	x8
PCIEX4_3	–	x4	x4



- We recommend that you provide sufficient power when running CrossFireX™ mode.
- Connect a chassis fan to the motherboard connector labeled CHA_FAN1-3 when using multiple graphics cards for better thermal environment.
- Only FM2+ processors can support PCIe 3.0 speed rate.



PCIEX16/X8_1 slot switches to x8 mode when PCIEX8_2 slot is occupied.

IRQ assignments for this motherboard

	A	B	C	D	E	F	G	H
PCIEX16	–	–	shared	–	–	–	–	–
PCIEX8	–	–	–	shared	–	–	–	–
PCIEX4	shared	–	–	–	–	–	–	–
PCIEX1_1	shared	–	–	–	–	–	–	–
ASM USB3.0	–	shared	–	–	–	–	–	–
Intel LAN Controller	–	–	shared	–	–	–	–	–
PCIEX1_2	–	–	–	shared	–	–	–	–
HD Audio	shared	–	–	–	–	–	–	–
SATA Controller	–	–	–	shared	–	–	–	–
OnChip XHCI Controller 1	–	–	shared	–	–	–	–	–
OnChip XHCI Controller 2	–	shared	–	–	–	–	–	–
OnChip USB EHCI	–	shared	–	–	–	–	–	–
OnChip USB OHCI	–	–	shared	–	–	–	–	–

1.2.6 Onboard buttons and switches

Onboard buttons allow you to fine-tune performance when working on a bare or open-case system. This is ideal for overclockers and gamers who continually change settings to enhance system performance.

1. Power-on button (START)

The motherboard comes with a power-on button that allows you to power up or wake up the system. The button also lights up when the system is plugged to a power source indicating that you should shut down the system and unplug the power cable before removing or installing any motherboard component.

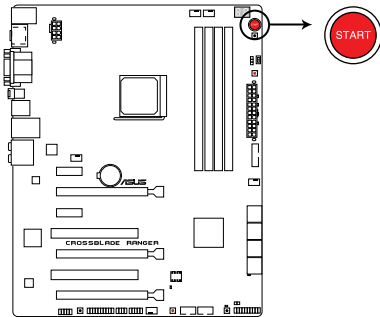

CROSSBLADE RANGER Power-on button

2. RESET button (RESET)

Press the reset button to reboot the system.

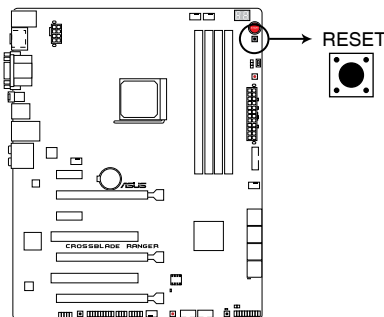

CROSSBLADE RANGER Reset button

3. MemOK! button (MemOK!)

Installing DIMMs that are not compatible with the motherboard may cause system boot failure. Press the MemOK! button until the memory compatibility tuning for successful boot.

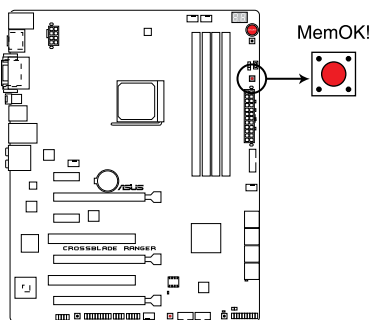

CROSSBLADE RANGER MemOK! button



- Turn off the system and reinstall the DIMM before using the MemOK! function.
- The MemOK! button does not function under Windows® OS environment.
- During the tuning process, the system loads and tests failsafe memory settings. It takes about 30 seconds for the system to test one set of failsafe settings. If the test fails, the system reboots and test the next set of failsafe settings.
- Due to memory tuning requirement, the system automatically reboots when each timing set is tested. If the installed DIMMs still fail to boot after the whole tuning process, replace the DIMMs with ones recommended in the Memory QVL (Qualified Vendors Lists) in this user manual or on the ASUS website at www.asus.com.
- If you turn off the computer and replace DIMMs during the tuning process, the system continues memory tuning after turning on the computer. To stop memory tuning, turn off the computer and unplug the power cord for about 5–10 seconds.
- If your system fails to boot up due to BIOS overclocking, press the MemOK! button to boot and load the BIOS default settings. A message will appear during POST reminding you that the BIOS has been restored to its default settings.
- We recommend that you download and update to the latest BIOS version from the ASUS website at www.asus.com after using the MemOK! function.

4. Clear CMOS button (CLR_CMOS)

Press this button to clear the BIOS setup information only when the systems hangs due to overclocking.

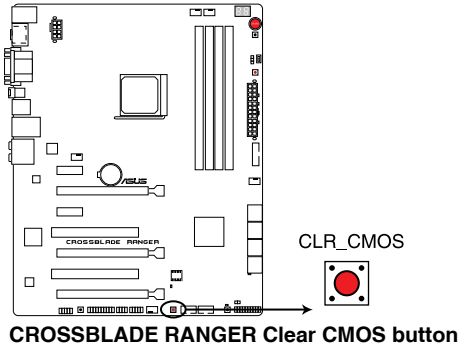

5. KeyBot button (KeyBot)

Press this button to activate the KeyBot feature.

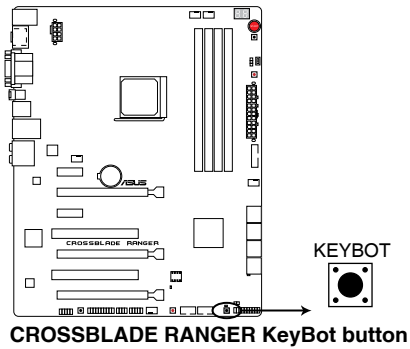

-
- The KeyBot feature supports USB keyboards only.
 - For more information about the KeyBot feature, refer to the Software Support chapter of this user guide.
-

6. Sonic SoundStage button (SOUNDSTAGE)

Press this button to activate the Sonic SoundStage feature.

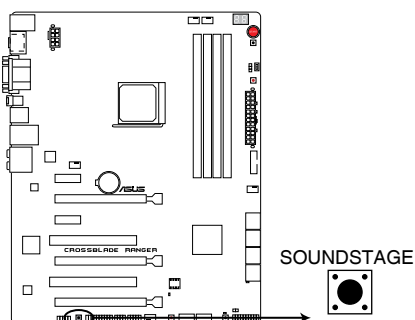

CROSSBLADE RANGER Sonic SoundStage button



- The debug code on the Q-Code LED shows the current Sonic SoundStage profile when you press the Sonic SoundStage button.
- For more information about Sonic SoundStage, refer to section **4.6 ROG audio features** of this user guide.

7. Slow Mode switch

Slow Mode switch allows your system to provide better overclocking margins when using the LN2 cooling system. When enabled, the Slow Mode switch prevents the system from crashing, slows down the CPU, and the system's tuner will make the adjustments.

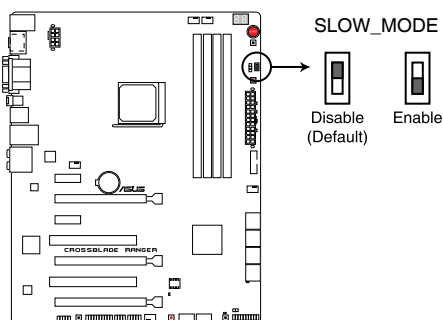

CROSSBLADE RANGER Slow mode switch



Ensure to set the LN2 Mode jumper to [Enable] before using the Slow Mode switch.

1.2.7 Jumpers

1. LN2 Mode Jumper (3-pin LN2)

When enabled, the LN2 Mode jumper allows your system to eliminate the cold bugs in the processor during POST. It allows the processor to run at an extremely low temperature and helps the system boot fast.

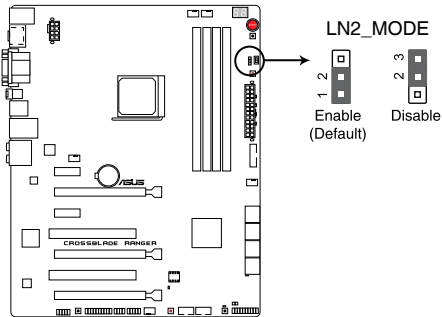

CROSSBLADE RANGER LN2 mode setting

1.2.8 Onboard LEDs

1. Hard Disk LED (HD_LED)

The Hard Disk LED is designed to indicate the hard disk activity. It blinks when data is being written into or read from the hard disk drive. The LED does not light up when there is no hard disk drive connected to the motherboard or when the hard disk drive does not function.

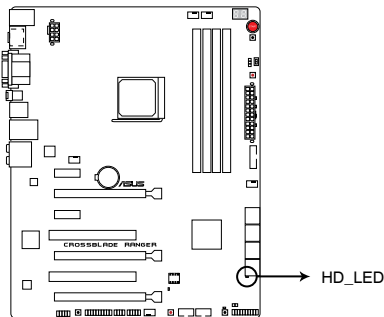

CROSSBLADE RANGER Hard Disk LED

2. Q LEDs (BOOT_DEVICE_LED, VGA_LED, DRAM_LED, CPU_LED)

Q LEDs check key components (CPU, DRAM, VGA card, and booting devices) in sequence during motherboard booting process. If an error is found, the corresponding LED flashes until the problem is solved. This user-friendly design provides an intuitive way to locate the root problem within seconds.

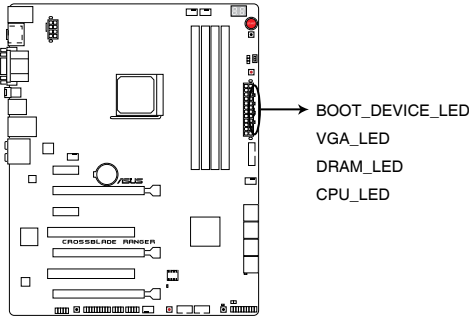

**CROSSBLADE RANGER CPU/DRAM/
BOOT_DEVICE/VGA/HD LED**

3. KeyBot LED (KEYBOT_LED)

This LED lights up when the KeyBot button is pressed.

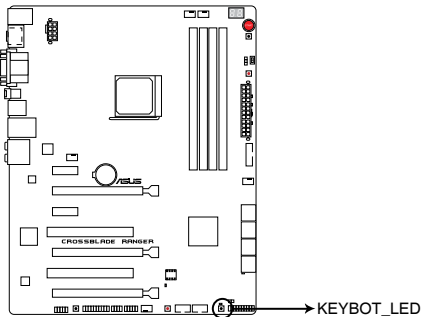

CROSSBLADE RANGER KeyBot LED

4. USB BIOS Flashback LED (FLBK_LED)

This LED flashes when you press the BIOS Flashback button for BIOS update.

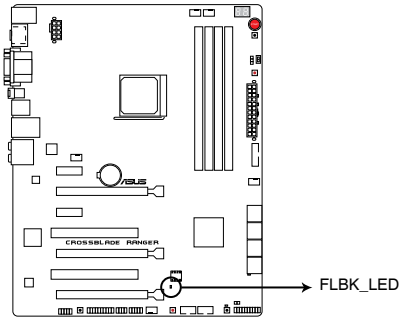

CROSSBLADE RANGER BIOS Flashback LED

5. Q-Code LED (Q_CODE)

The Q-Code LED design provides you with a 2-digit error code that displays the system status. Refer to the Q-Code table on the following page for details.

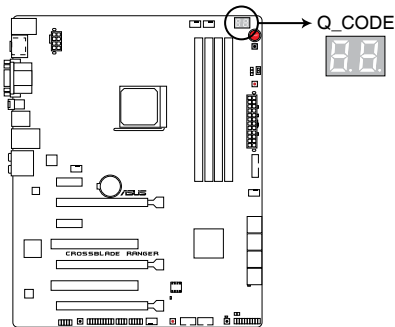

CROSSBLADE RANGER Q-Code LED

Q-Code table

Code	Description
00	Not used
01	Power on. Reset type detection (soft/hard).
02	AP initialization before microcode loading
03	System Agent initialization before microcode loading
04	PCH initialization before microcode loading
06	Microcode loading
07	AP initialization after microcode loading
08	System Agent initialization after microcode loading
09	PCH initialization after microcode loading
0B	Cache initialization
0C – 0D	Reserved for future AMI SEC error codes
0E	Microcode not found
0F	Microcode not loaded
10	PEI Core is started
11 – 14	Pre-memory CPU initialization is started
15 – 18	Pre-memory System Agent initialization is started
19 – 1C	Pre-memory PCH initialization is started
2B – 2F	Memory initialization
30	Reserved for ASL (see ASL Status Codes section below)
31	Memory Installed
32 – 36	CPU post-memory initialization
37 – 3A	Post-Memory System Agent initialization is started
3B – 3E	Post-Memory PCH initialization is started
4F	DXE IPL is started
50 – 53	Memory initialization error. Invalid memory type or incompatible memory speed
54	Unspecified memory initialization error
55	Memory not installed
56	Invalid CPU type or Speed
57	CPU mismatch
58	CPU self test failed or possible CPU cache error
59	CPU micro-code is not found or micro-code update is failed

(continued on the next page)

Q-Code table

Code	Description
10	PEI Core is started
11 – 14	Pre-memory CPU initialization is started
15 – 18	Pre-memory System Agent initialization is started
19 – 1C	Pre-memory PCH initialization is started
2B – 2F	Memory initialization
30	Reserved for ASL (see ASL Status Codes section below)
31	Memory Installed
32 – 36	CPU post-memory initialization
37 – 3A	Post-Memory System Agent initialization is started
3B – 3E	Post-Memory PCH initialization is started
4F	DXE IPL is started
50 – 53	Memory initialization error. Invalid memory type or incompatible memory speed
54	Unspecified memory initialization error
55	Memory not installed
56	Invalid CPU type or Speed
57	CPU mismatch
58	CPU self test failed or possible CPU cache error
59	CPU micro-code is not found or micro-code update is failed
5A	Internal CPU error
5B	Reset PPI is not available
5C – 5F	Reserved for future AMI error codes
E0	S3 Resume is started (S3 Resume PPI is called by the DXE IPL)
E1	S3 Boot Script execution
E2	Video repost
E3	OS S3 wake vector call
E4 – E7	Reserved for future AMI progress codes
E8	S3 Resume Failed
E9	S3 Resume PPI not Found
EA	S3 Resume Boot Script Error
EB	S3 OS Wake Error
EC – EF	Reserved for future AMI error codes

(continued on the next page)

Q-Code table

Code	Description
F0	Recovery condition triggered by firmware (Auto recovery)
F1	Recovery condition triggered by user (Forced recovery)
F2	Recovery process started
F3	Recovery firmware image is found
F4	Recovery firmware image is loaded
F5 – F7	Reserved for future AMI progress codes
F8	Recovery PPI is not available
F9	Recovery capsule is not found
FA	Invalid recovery capsule
FB – FF	Reserved for future AMI error codes
60	DXE Core is started
61	NVRAM initialization
62	Installation of the PCH Runtime Services
63 – 67	CPU DXE initialization is started
68	PCI host bridge initialization
69	System Agent DXE initialization is started
6A	System Agent DXE SMM initialization is started
6B – 6F	System Agent DXE initialization (System Agent module specific)
70	PCH DXE initialization is started
71	PCH DXE SMM initialization is started
72	PCH devices initialization
73 – 77	PCH DXE Initialization (PCH module specific)
78	ACPI module initialization
79	CSM initialization
7A – 7F	Reserved for future AMI DXE codes
90	Boot Device Selection (BDS) phase is started
91	Driver connecting is started
92	PCI Bus initialization is started
93	PCI Bus Hot Plug Controller Initialization
94	PCI Bus Enumeration
95	PCI Bus Request Resources

(continued on the next page)

Q-Code table

Code	Description
96	PCI Bus Assign Resources
97	Console Output devices connect
98	Console input devices connect
99	Super IO Initialization
9A	USB initialization is started
9B	USB Reset
9C	USB Detect
9D	USB Enable
9E – 9F	Reserved for future AMI codes
A0	IDE initialization is started
A1	IDE Reset
A2	IDE Detect
A3	IDE Enable
A4	SCSI initialization is started
A5	SCSI Reset
A6	SCSI Detect
A7	SCSI Enable
A8	Setup Verifying Password
A9	Start of Setup
AA	Reserved for ASL (see ASL Status Codes section below)
AB	Setup Input Wait
AC	Reserved for ASL (see ASL Status Codes section below)
AD	Ready To Boot event
AE	Legacy Boot event
AF	Exit Boot Services event
B0	Runtime Set Virtual Address MAP Begin
B1	Runtime Set Virtual Address MAP End
B2	Legacy Option ROM Initialization
B3	System Reset
B4	USB hot plug
B5	PCI bus hot plug

(continued on the next page)

Q-Code table

Code	Description
B6	Clean-up of NVRAM
B7	Configuration Reset (reset of NVRAM settings)
B8– BF	Reserved for future AML codes
D0	CPU initialization error
D1	System Agent initialization error
D2	PCH initialization error
D3	Some of the Architectural Protocols are not available
D4	PCI resource allocation error. Out of Resources
D5	No Space for Legacy Option ROM
D6	No Console Output Devices are found
D7	No Console Input Devices are found
D8	Invalid password
D9	Error loading Boot Option (LoadImage returned error)
DA	Boot Option is failed (StartImage returned error)
DB	Flash update is failed
DC	Reset protocol is not available

ACPI/ASL Checkpoints

Code	Description
0x01	System is entering S1 sleep state
0x02	System is entering S2 sleep state
0x03	System is entering S3 sleep state
0x04	System is entering S4 sleep state
0x05	System is entering S5 sleep state
0x10	System is waking up from the S1 sleep state
0x20	System is waking up from the S2 sleep state
0x30	System is waking up from the S3 sleep state
0x40	System is waking up from the S4 sleep state
0xAC	System has transitioned into ACPI mode. Interrupt controller is in PIC mode.
0xAA	System has transitioned into ACPI mode. Interrupt controller is in APIC mode.

1.2.9 Internal connectors

1. AMD® A88X Serial ATA 6 Gb/s connectors (7-pin SATA6G_1-8 [red])

These connectors connect to Serial ATA 6 Gb/s hard disk drives via Serial ATA 6 Gb/s signal cables.

If you installed Serial ATA hard disk drives, you can create a RAID 0, 1, 5, and 10 configuration through the onboard AMD® A88X chipset.

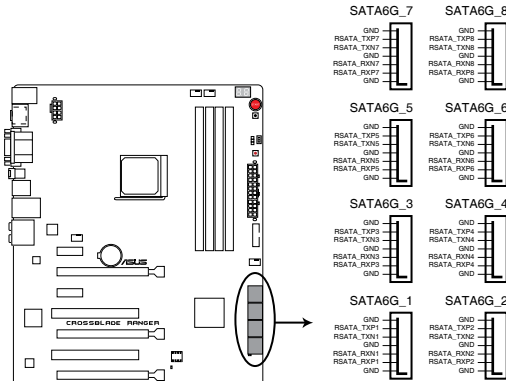

CROSSBLADE RANGER SATA 6.0Gb/s connectors

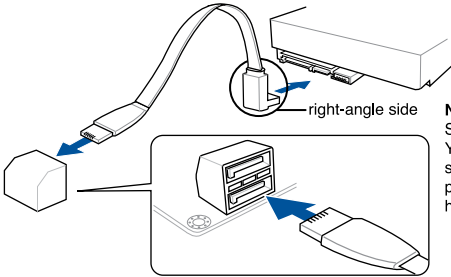

NOTE: Connect the right-angle side of SATA signal cable to SATA device. You may also connect the right-angle side of SATA cable to the onboard SATA port to avoid mechanical conflict with huge graphics cards.



- These connectors are set to **[AHCI]** by default. If you intend to create a Serial ATA RAID set using these connectors, set the SATA Mode item in the BIOS to **[RAID]**. Refer to section **SATA Configuration** for details.
- Before creating a RAID set, refer to section **RAID configurations** or the manual bundled in the motherboard support DVD.
- When using NCQ, set the SATA Mode in the BIOS to **[AHCI]**. Refer to section **SATA Configuration** for details.

2. USB 3.0 connector (20-1 pin USB3_12)

This connector allows you to connect a USB 3.0 module for additional USB 3.0 front or rear panel ports. With an installed USB 3.0 module, you can enjoy all the benefits of USB 3.0 including faster data transfer speeds of up to 5Gbps, faster charging time for USB-chargeable devices, optimized power efficiency, and backward compatibility with USB 2.0.

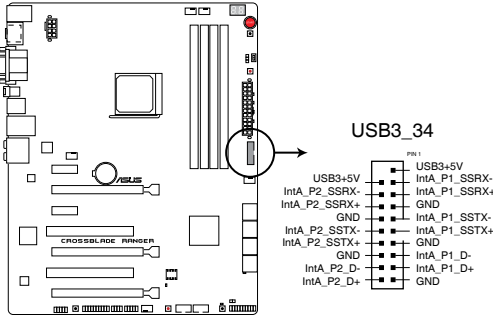

CROSSBLADE RANGER USB3.0 front panel connector



The USB 3.0 module is purchased separately.



You can connect the ASUS front panel USB 3.0 bracket to this connector to obtain the front panel USB 3.0 solution.

3. USB 2.0 connectors (10-1 pin USB34, USB56, USB78)

These connectors are for USB 2.0 ports. Connect the USB module cable to any of these connectors, then install the module to a slot opening at the back of the system chassis. These USB connectors comply with USB 2.0 specification that supports up to 480 MBps connection speed.

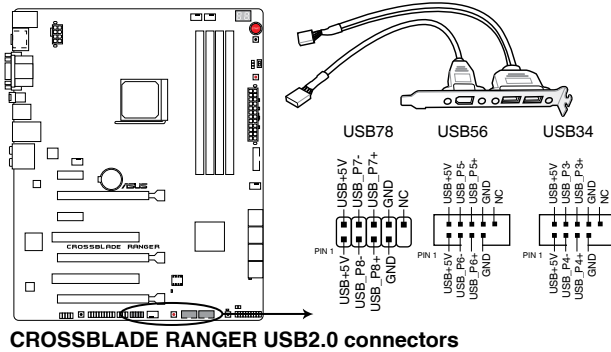

CROSSBLADE RANGER USB2.0 connectors



Never connect a 1394 cable to the USB connectors. Doing so will damage the motherboard!



You can connect the front panel USB cable to the ASUS Q-Connector (USB) first, and then install the Q-Connector (USB) to the USB connector onboard if your chassis supports front panel USB ports.



2 x USB 2.0 ports (USB78) at mid-board shares with ROG extension (ROG_EXT) port.

4. Front panel audio connector (10-1 pin AAFP)

This connector is for a chassis-mounted front panel audio I/O module that supports either HD Audio or legacy AC'97 audio standard. Connect one end of the front panel audio I/O module cable to this connector.

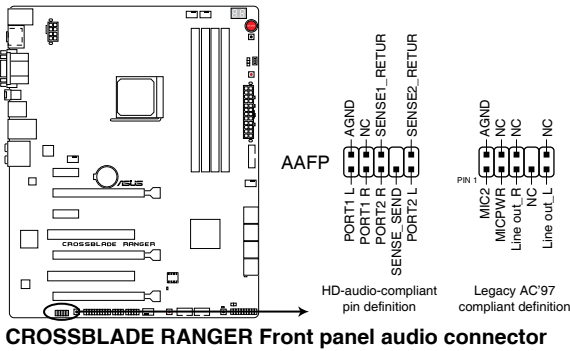

- We recommend that you connect a high-definition front panel audio module to this connector to avail of the motherboard's high-definition audio capability.
- If you want to connect a high-definition or an AC'97 front panel audio module to this connector, set the **Front Panel Type** item in the BIOS setup to **[HD]** or **[AC97]**.

5. Direct connector (2-pin DRCT)

This connector is for the chassis-mounted button that supports the DirectKey function. Connect the button cable that supports DirectKey, from the chassis to this connector on the motherboard.

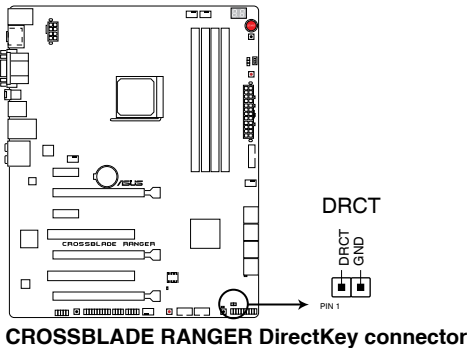

Ensure that your chassis comes with the button cable that supports the DirectKey feature. Refer to the technical documentation that came with the chassis for details.

6. CPU, chassis, and optional fan connectors (4-pin CPU_FAN; 4-pin CPU_OPT; 4-pin CHA_FAN1-3)

Connect the fan cables to the fan connectors on the motherboard, ensuring that the black wire of each cable matches the ground pin of the connector.

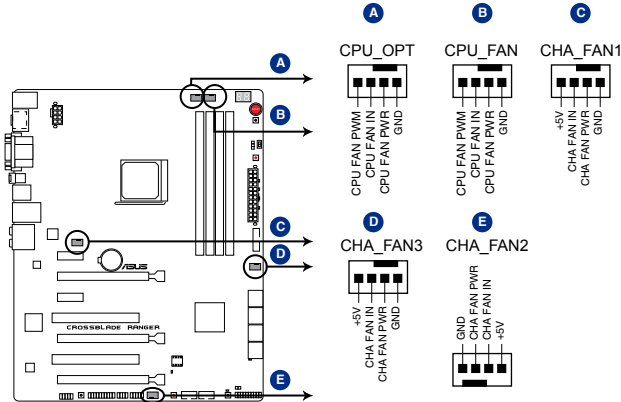

CROSSBLADE RANGER Fan connectors



- DO NOT forget to connect the fan cables to the fan connectors. Insufficient air flow inside the system may damage the motherboard components. These are not jumpers! Do not place jumper caps on the fan connectors!
- Ensure to fully insert the 4-pin CPU fan cable to the CPU fan connector.



The CPU_FAN connector supports the CPU fan of maximum 1A (12 W) fan power.

7. ATX power connectors (24-pin EATXPWR; 8-pin EATX12V)

These connectors are for ATX power supply plugs. The power supply plugs are designed to fit these connectors in only one orientation. Find the proper orientation and push down firmly until the connectors completely fit.

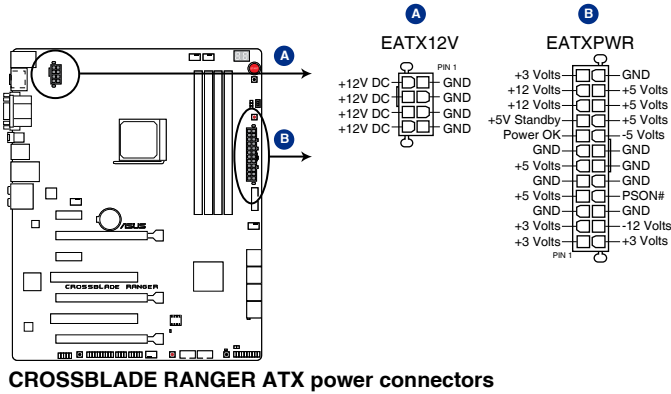

CROSSBLADE RANGER ATX power connectors



- For a fully configured system, we recommend that you use a power supply unit (PSU) that complies with ATX 12 V Specification 2.0 (or later version) and provides a minimum power of 350 W.
- Do not forget to connect the 4-pin/8-pin EATX12 V power plug. Otherwise, the system will not boot.
- We recommend that you use a PSU with a higher power output when configuring a system with more power-consuming devices. The system may become unstable or may not boot up if the power is inadequate.
- If you want to use two or more high-end PCIe x16 cards, use a PSU with 1000W power or above to ensure the system stability.
- If you are uncertain about the minimum power supply requirement for your system, refer to the Recommended Power Supply Wattage Calculator at <http://support.asus.com/PowerSupplyCalculator/PSCalculator.aspx?SLanguage=en-us> for details.

8. System panel connector (20-8 pin PANEL)

This connector supports several chassis-mounted functions.

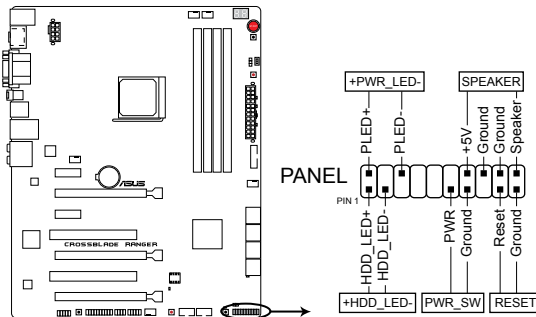

CROSSBLADE RANGER System panel connector

- **System power LED (2-pin PWR_LED)**

This 2-pin connector is for the system power LED. Connect the chassis power LED cable to this connector. The system power LED lights up when you turn on the system power, and blinks when the system is in sleep mode.

- **Hard disk drive activity LED (2-pin HDD_LED)**

This 2-pin connector is for the HDD Activity LED. Connect the HDD Activity LED cable to this connector. The HDD LED lights up or flashes when data is read from or written to the HDD.

- **System warning speaker (4-pin SPEAKER)**

This 4-pin connector is for the chassis-mounted system warning speaker. The speaker allows you to hear system beeps and warnings.

- **ATX power button/soft-off button (2-pin PWRSW)**

This connector is for the system power button. Pressing the power button turns the system on or puts the system in sleep or soft-off mode depending on the BIOS settings. Pressing the power button for more than four seconds while the system is ON turns the system OFF.

- **Reset button (2-pin RESET)**

This 2-pin connector is for the chassis-mounted reset button for system reboot without turning off the system power.

9. ROG Extension - ROG_EXT connector (18-1 pin ROG_EXT)

This connector is for the Front Base.

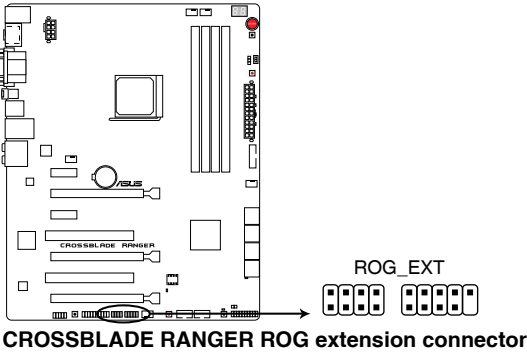

- The Front Base is purchased separately.
- Visit www.asus.com for more information about the Front Base.

10. TPM connector (20-1 pin TPM)

This connector supports a Trusted Platform Module (TPM) system, which securely store keys, digital certificates, passwords and data. A TPM system also helps enhance the network security, protects digital identities, and ensures platform integrity.

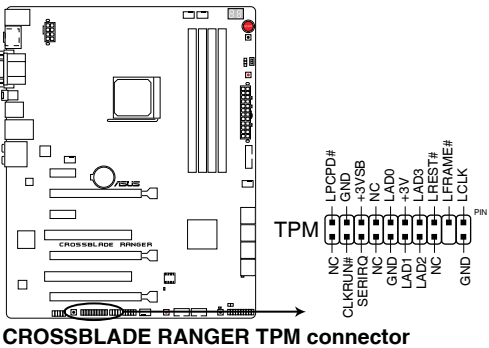

- The TPM module is purchased separately.

Basic Installation

2

2.1 Building your PC system

2.1.1 Motherboard installation



The diagrams in this section are for reference only. The motherboard layout may vary with models, but the installation steps are the same for all models.

1. Install the ASUS Q-Shield to the chassis rear I/O panel.

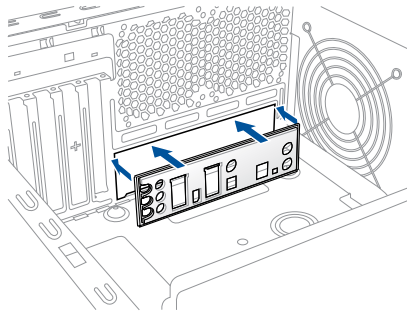

2. Place the motherboard into the chassis, ensuring that its rear I/O ports are aligned to the chassis' rear I/O panel.

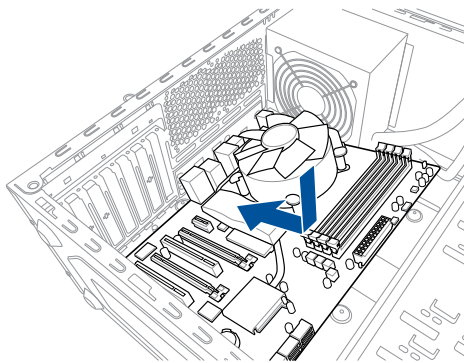

3. Place nine screws into the holes indicated by circles to secure the motherboard to the chassis.

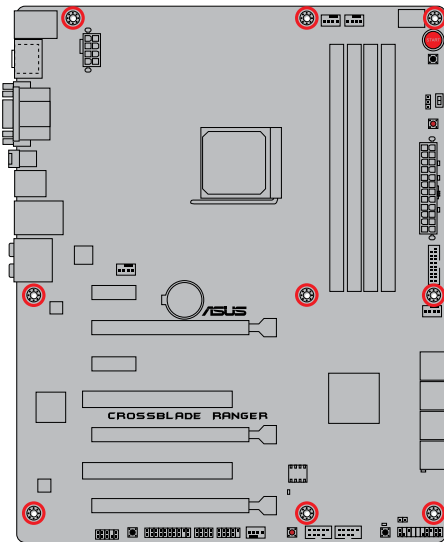
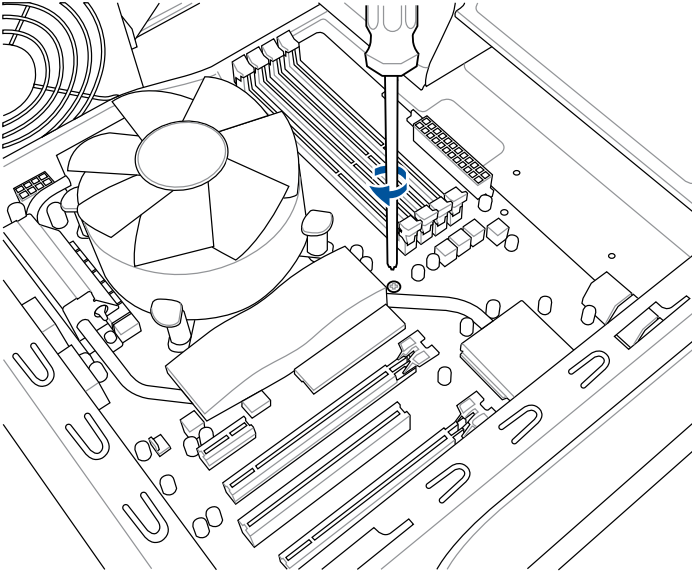

DO NOT over tighten the screws! Doing so can damage the motherboard.

2.1.2 APU installation



Ensure that you use an APU designed for the FM2+ socket. The APU fits in only one correct orientation. DO NOT force the APU into the socket to prevent bending the pins and damaging the APU!

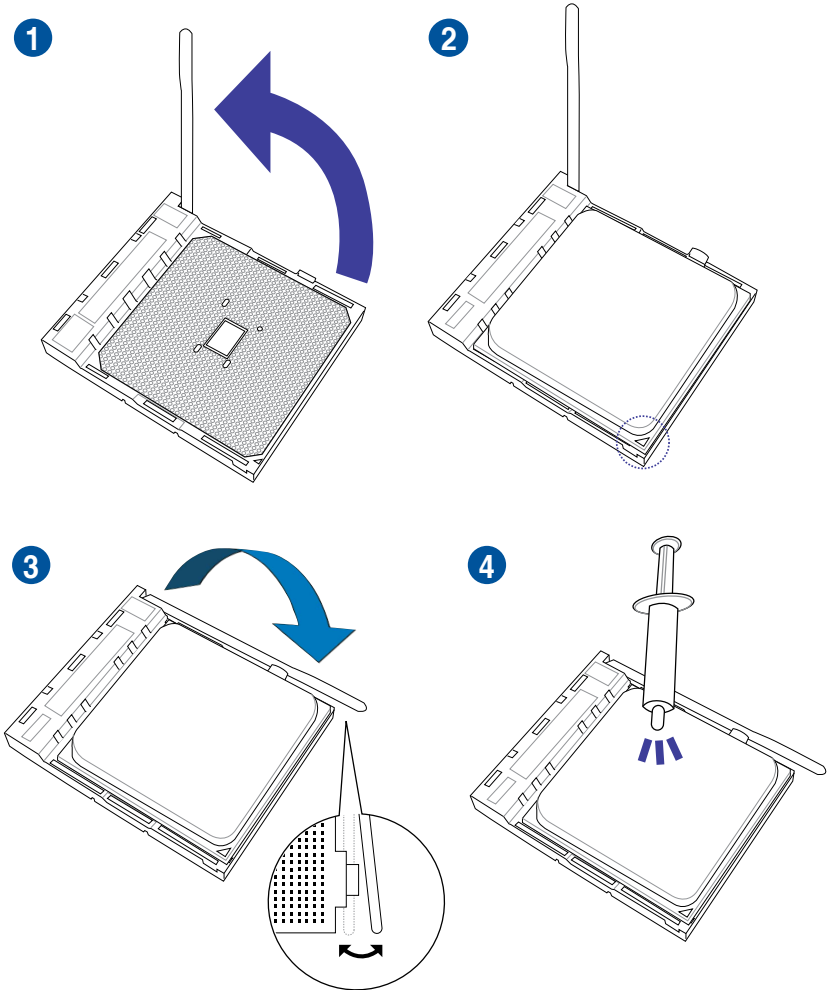

2.1.3 APU heatsink and fan assembly installation

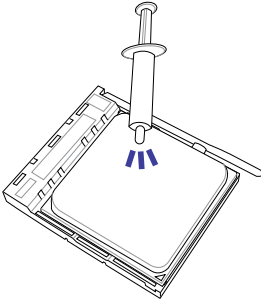

Apply the Thermal Interface Material to the APU heatsink and APU before you install the heatsink and fan if necessary.

To install the APU heatsink and fan assembly

1

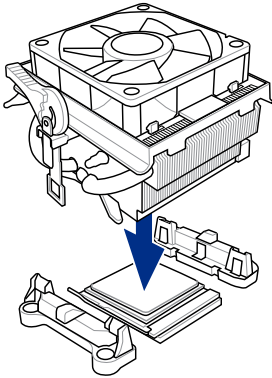

2

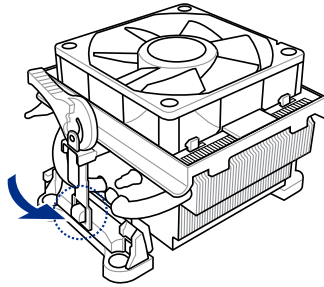

3

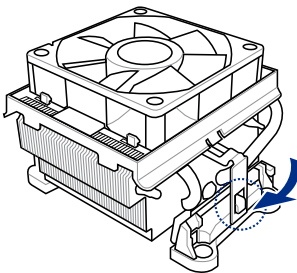

4

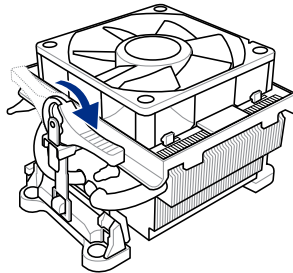

5

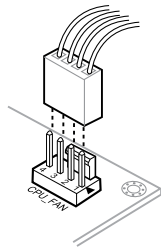

To uninstall the APU heatsink and fan assembly

1

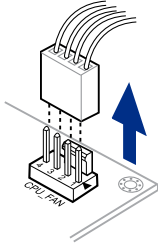

2

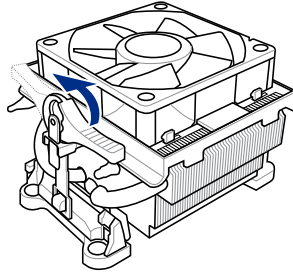

3

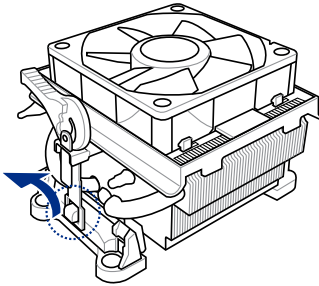

4

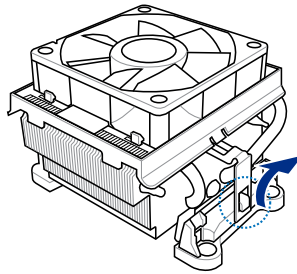

5

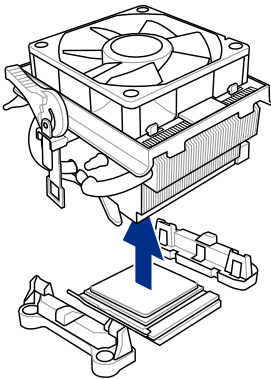

2.1.4 DIMM installation

1

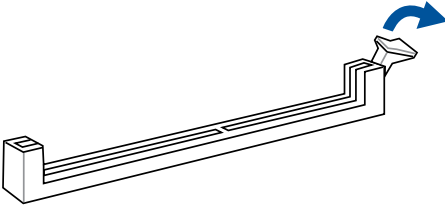

2

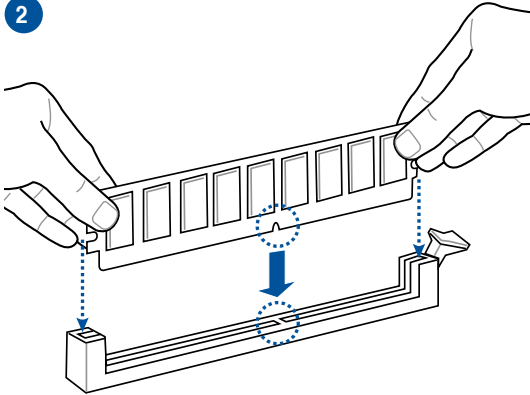

3

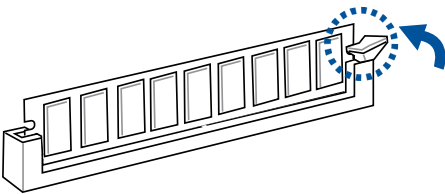

To remove a DIMM

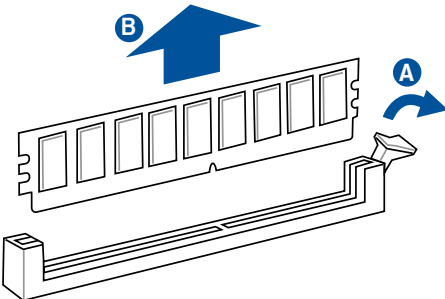

2.1.5 ATX Power connection

1

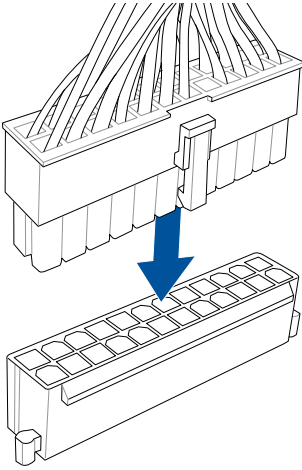

2

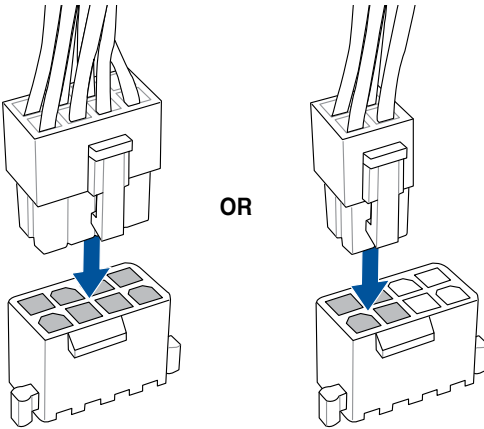

2.1.6 SATA device connection

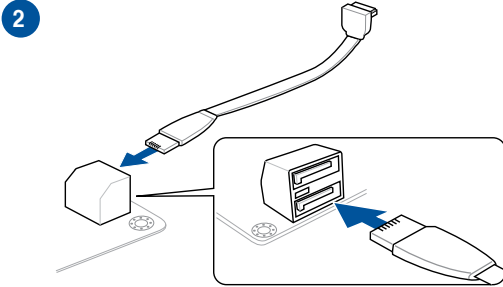
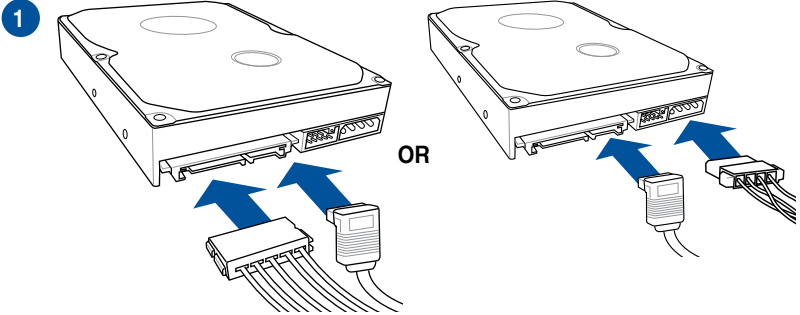

2.1.7 Front I/O Connector

To install ASUS Q-Connector

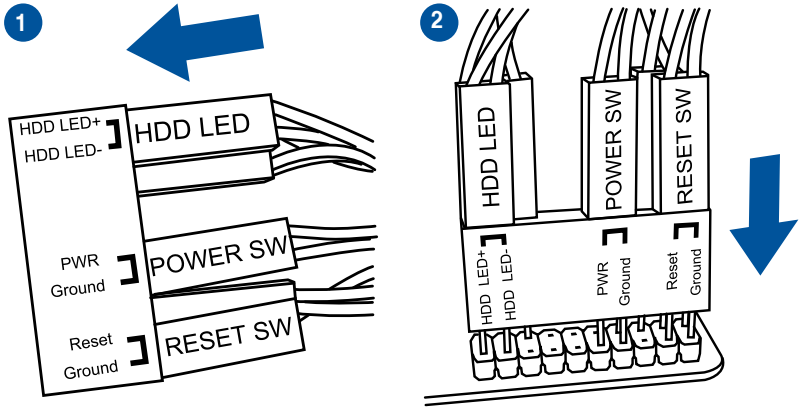

To install USB 2.0 connector

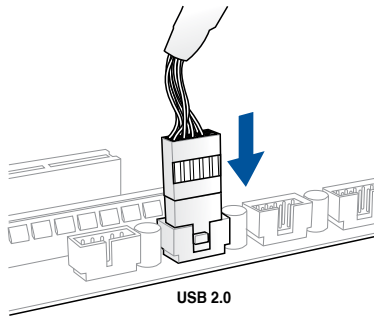

To install front panel audio connector

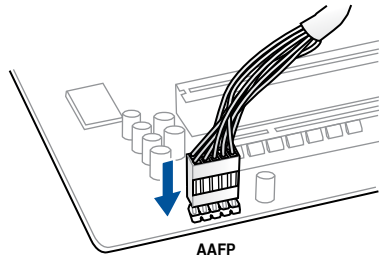

To install USB 3.0 connector

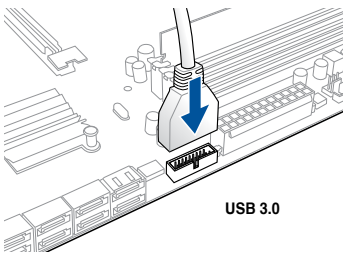

2.1.8 Expansion Card installation

To install PCIe x16 cards

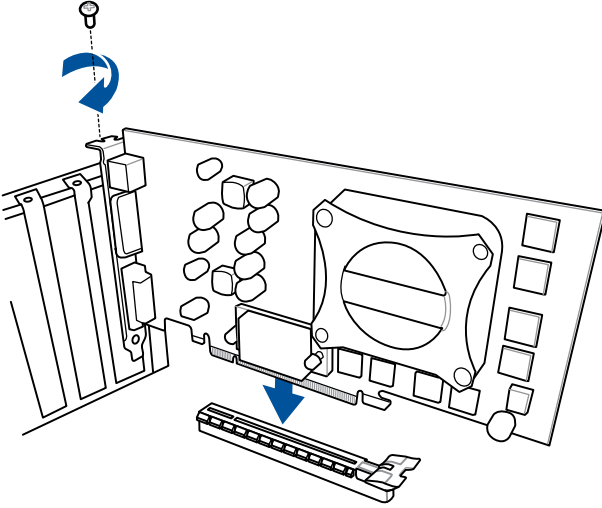

To install PCIe x1 cards

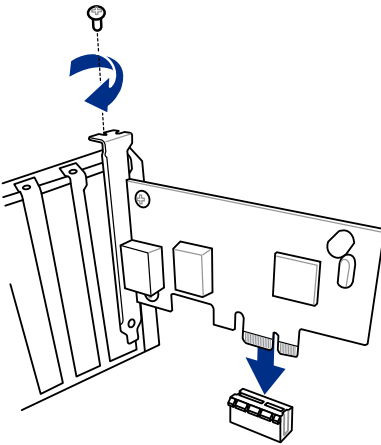

To install PCI cards

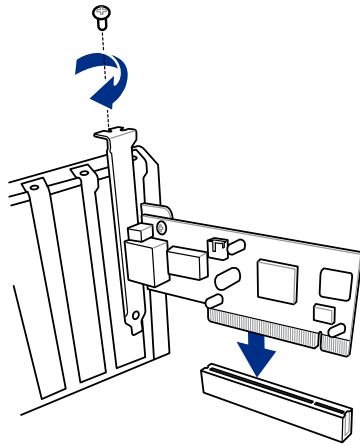

2.2 BIOS update utility

USB BIOS Flashback

USB BIOS Flashback allows you to easily update the BIOS without entering the existing BIOS or operating system. Simply insert a USB storage device to the USB port, press the USB BIOS Flashback button for three seconds, and the BIOS is updated automatically.

To use USB BIOS Flashback:

1. Download the latest BIOS file from the ASUS website.
2. Extract and rename the BIOS image file to **CROSLDR.CAP**.
3. Copy **CROSLDR.CAP** to the root directory of your USB storage device.
4. Turn off the system and connect the USB storage device to the USB BIOS Flashback port.
5. Press the USB BIOS Flashback button.



A flashing light indicates that the BIOS Flashback function is enabled. The light goes out when the process of updating the BIOS is complete.

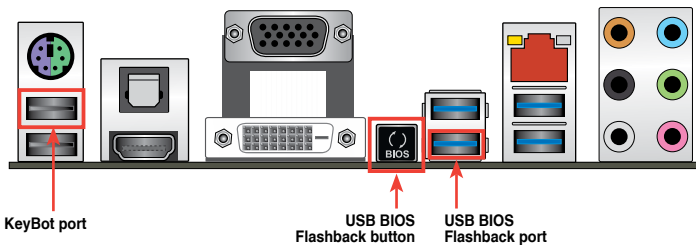

- For more BIOS update utilities in BIOS setup, refer to the section **Updating BIOS** in Chapter 3.
- Connect your USB keyboard on the KeyBot port if you want to use the KeyBot feature.



Updating BIOS may have risks. If the BIOS program is damaged during the process and results to the system's failure to boot up, please contact your local ASUS Service Center.

2.3 Motherboard rear and audio connections

2.3.1 Rear I/O connection

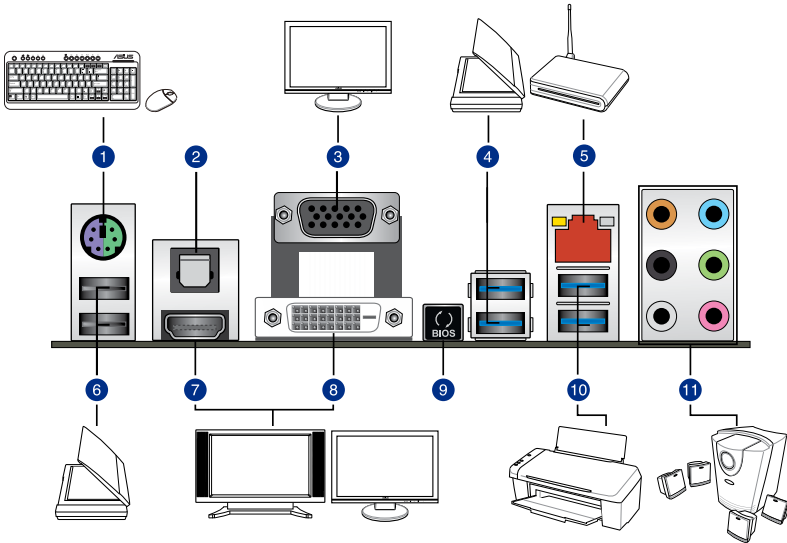

Rear panel connectors

1. PS/2 Keyboard/Mouse combo port
2. Optical S/PDIF OUT port
3. VGA port
4. Intel® USB 3.0 ports 1 and 2. Lower port supports the USB BIOS Flasback feature.
5. LAN (RJ-45) port*
6. Intel® USB 2.0 ports 1 and 2. Upper port supports the KeyBot feature.
7. HDMI port
8. DVI port
9. USB BIOS Flashback button
10. ASMedia® USB 3.0 ports 1 and 2.
11. Audio I/O ports**

* and **: Refer to the tables on the next page for LAN port LEDs, and audio port definitions.



- Due to USB 3.0 controller limitation, USB 3.0 devices can only be used under Windows® OS environment and after the USB 3.0 driver installation.
- USB 3.0 devices can only be used as data storage only.
- We strongly recommend that you connect USB 3.0 devices to USB 3.0 ports for faster and better performance for your USB 3.0 devices.

* LAN ports LED indications

Activity Link LED		Speed LED	
Status	Description	Status	Description
OFF	No link	OFF	10 Mbps connection
ORANGE	Linked	ORANGE	100 Mbps connection
BLINKING	Data activity	GREEN	1 Gbps connection

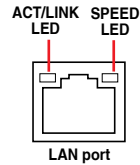

** Audio 2.1, 4.1, 5.1 or 7.1-channel configuration

Port	Headset 2.1-channel	4.1-channel	5.1-channel	7.1-channel
Light Blue	Line In	Line In	Line In	Line In
Lime	Line Out	Front Speaker Out	Front Speaker Out	Front Speaker Out
Pink	Mic In	Mic In	Mic In	Mic In
Orange	–	–	Center/Sub woofer	Center/Sub woofer
Black	–	Rear Speaker Out	Rear Speaker Out	Rear Speaker Out
Gray	–	–	–	Side Speaker Out

2.3.2 Audio I/O connections

Audio I/O ports

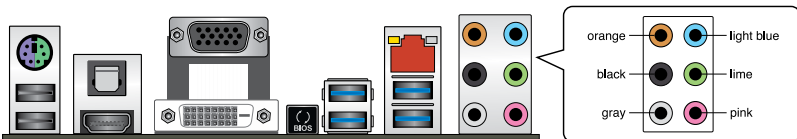

Connect to Headphone and Mic



Connect to Stereo Speakers

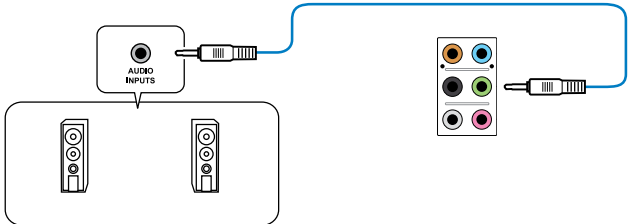

Connect to 2.1 channel Speakers

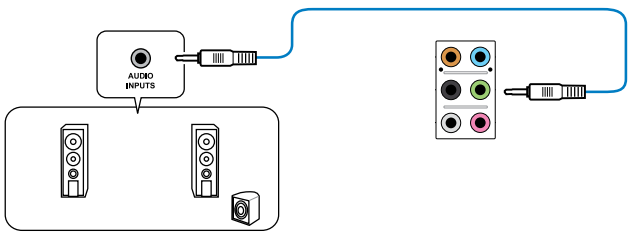

Connect to 4.1 channel Speakers

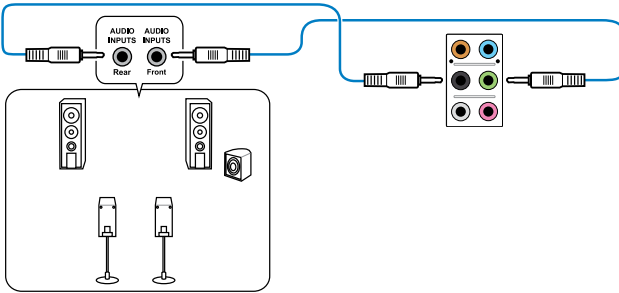

Connect to 5.1 channel Speakers

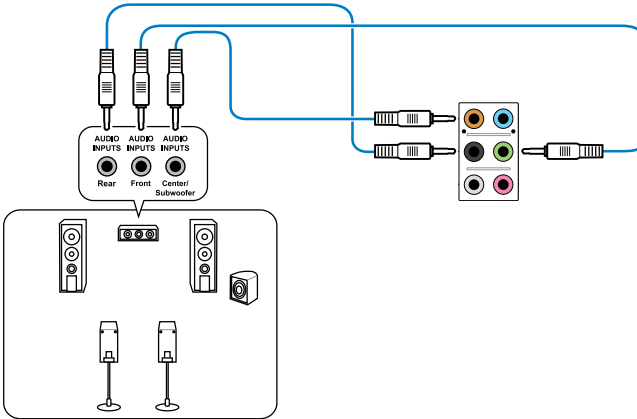

Connect to 7.1 channel Speakers

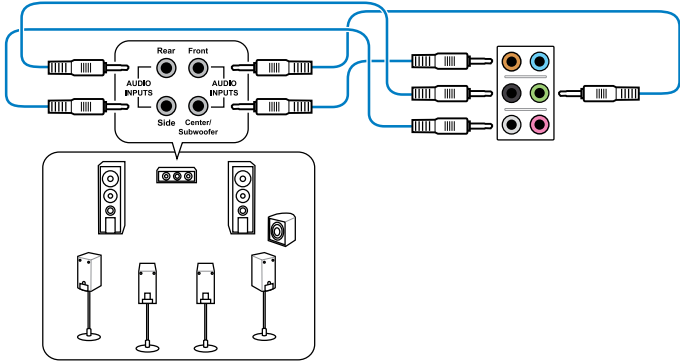

2.4 Starting up for the first time

1. After making all the connections, replace the system case cover.
2. Ensure that all switches are off.
3. Connect the power cord to the power connector at the back of the system chassis.
4. Connect the power cord to a power outlet that is equipped with a surge protector.
5. Turn on the devices in the following order:
 - a. Monitor
 - b. External SCSI devices (starting with the last device on the chain)
 - c. System power
6. After applying power, the system power LED on the system front panel case lights up. For systems with ATX power supplies, the system LED lights up when you press the ATX power button. If your monitor complies with the “green” standards or if it has a “power standby” feature, the monitor LED may light up or change from orange to green after the system LED turns on.

The system then runs the power-on self tests (POST). While the tests are running, the BIOS beeps (refer to the BIOS beep codes table) or additional messages appear on the screen. If you do not see anything within 30 seconds from the time you turned on the power, the system may have failed a power-on test. Check the jumper settings and connections or call your retailer for assistance.

BIOS Beep	Description
One short beep	VGA detected Quick boot set to disabled No keyboard detected
One continuous beep followed by two short beeps then a pause (repeated)	No memory detected
One continuous beep followed by three short beeps	No VGA detected
One continuous beep followed by four short beeps	Hardware component failure

7. At power on, hold down the <Delete> key to enter the BIOS Setup. Follow the instructions in Chapter 3.

2.5 Turning off the computer

While the system is ON, press the power button for less than four seconds to put the system on sleep mode or soft-off mode, depending on the BIOS setting. Press the power button for more than four seconds to let the system enter the soft-off mode regardless of the BIOS setting.

BIOS setup

3

3.1 Knowing BIOS



The new ASUS UEFI BIOS is a Unified Extensible Interface that complies with UEFI architecture, offering a user-friendly interface that goes beyond the traditional keyboard-only BIOS controls to enable a more flexible and convenient mouse input. You can easily navigate the new UEFI BIOS with the same smoothness as your operating system. The term “BIOS” in this user manual refers to “UEFI BIOS” unless otherwise specified.

BIOS (Basic Input and Output System) stores system hardware settings such as storage device configuration, overclocking settings, advanced power management, and boot device configuration that are needed for system startup in the motherboard CMOS. In normal circumstances, the default BIOS settings apply to most conditions to ensure optimal performance. **DO NOT change the default BIOS settings** except in the following circumstances:

- An error message appears on the screen during the system bootup and requests you to run the BIOS Setup.
- You have installed a new system component that requires further BIOS settings or update.



Inappropriate BIOS settings may result to instability or boot failure. **We strongly recommend that you change the BIOS settings only with the help of a trained service personnel.**



When downloading or updating the BIOS file, rename it as **CROSBLDR.CAP** for this motherboard.

3.2 BIOS setup program

Use the BIOS Setup to update the BIOS or configure its parameters. The BIOS screen include navigation keys and brief onscreen help to guide you in using the BIOS Setup program.

Entering BIOS at startup

To enter BIOS Setup at startup, press <Delete> or <F2> during the Power-On Self Test (POST). If you do not press <Delete> or <F2>, POST continues with its routines.

Entering BIOS Setup after POST

To enter BIOS Setup after POST:

- Press <Ctrl>+<Alt>+<Delete> simultaneously.
- Press the reset button on the system chassis.
- Press the power button to turn the system off then back on. Do this option only if you failed to enter BIOS Setup using the first two options.



-
- The BIOS setup screens shown in this section are for reference purposes only, and may not exactly match what you see on your screen.
 - Ensure that a USB mouse is connected to your motherboard if you want to use the mouse to control the BIOS setup program.
 - If the system becomes unstable after changing any BIOS setting, load the default settings to ensure system compatibility and stability. Select the **Load Optimized Defaults** item under the **Exit** menu or press hotkey <F5>. See section **Exit Menu** for details.
 - If the system fails to boot after changing any BIOS setting, try to clear the CMOS and reset the motherboard to the default value. See section **Onboard buttons** for more information on how to erase the RTC RAM via the Clear CMOS button.
 - The BIOS setup program does not support the bluetooth devices.
-

BIOS menu screen

The BIOS Setup program can be used under two modes: **EZ Mode** and **Advanced Mode**. Press <F7> to change between the two modes.

3.2.1 EZ Mode

The EZ Mode provides you an overview of the basic system information, and allows you to select the display language, system performance mode, fan profile and boot device priority. To access the Advanced Mode, click **Advanced Mode(F7)** or press <F7>.



The default screen for entering the BIOS setup program can be changed. Refer to the **Setup Mode** item in section **Boot menu** for details.

The screenshot shows the ASUS UEFI BIOS Utility - EZ Mode interface. The interface is divided into several sections:

- Information:** Displays system details such as CROSSBLADE RANGER BIOS Ver. 0501, AMD A8-5600K APU with Radeon(tm) HD Graphics, Speed: 3600 Mhz, and Memory: 1024 MB (DDR3 1333MHz).
- CPU Temperature:** Shows a temperature of 77°C.
- CPU Voltage:** Shows a voltage of 1.362 V.
- Motherboard Temperature:** Shows a temperature of 33°C.
- DRAM Status:** Lists DIMM slots A1 through A4, all showing N/A.
- SATA Information:** Lists SATA ports P1 through P8, all showing N/A.
- EZ System Tuning:** Allows selection of system performance modes: Performance, Quiet, and Energy Saving. The current mode is Normal.
- Boot Priority:** Allows selection of boot devices. The current boot priority is 3SYSTEM USB Flash Disk (7639MB).
- FAN Profile:** Shows CPU FAN (3391 RPM), CHA1 FAN (N/A), and CHA3 FAN (N/A).
- CPU FAN:** A graph showing fan speed (0-100%) vs. temperature (0-100°C). A "Manual Fan Tuning" button is present.
- Navigation:** Buttons for Default(F5), Save & Exit(F10), and Advanced Mode(F7) are at the bottom.

Callouts and their descriptions:

- Displays the CPU/motherboard temperature, CPU voltage output, CPU/chassis/power fan speed, and SATA information
- Selects the display language of the BIOS setup program
- Displays the system properties of the selected mode. Click < or > to switch EZ System Tuning modes
- Creates storage RAID and configures system overclocking
- Displays the CPU Fan's speed. Click the button to manually tune the fans
- Saves the changes and resets the system
- Click to go to Advanced mode
- Click to display boot devices
- Selects the boot device priority
- Loads optimized default settings



The boot device options vary depending on the devices you installed to the system.

3.2.2 Advanced Mode

The Advanced Mode provides advanced options for experienced end-users to configure the BIOS settings. The figure below shows an example of the Advanced Mode. Refer to the following sections for the detailed configurations.



To switch from EZ Mode to Advanced Mode, click **Advanced Mode(F7)** or press **F7** hotkey.

The screenshot shows the UEFI BIOS Utility in Advanced Mode. The interface is dark-themed with red accents. At the top, there is a menu bar with options: My Favorites, Extreme Tweaker, Main, Advanced, Monitor, Boot, Tool, and Exit. A Quick Note (F9) scroll bar is visible on the right. The main area displays various settings such as LN2 Mode (Disabled), Target CPU Speed (3600MHz), Target DRAM Speed (1333MHz), AI Overclock Tuner (Auto), Memory Frequency, CPU Ratio, NB Frequency, EPU Power Saving Mode (Disabled), GPU Boost (Auto), and Xtreme Tweaking (OC Tuner and DRAM Timing Control). A Hardware Monitor section on the right shows CPU, Memory, and Voltage status. A bottom status bar includes 'Last Modified', 'EzMode(F7)', and 'Version 2.16.1240. Copyright (C) 2014 American Megatrends, Inc.'.

Configuration fields
Pop-up Menu
Menu bar Language MyFavorite(F3) Qfan Control(F6) EZ Tuning Wizard(F11) Scroll bar Hot Keys
Quick Note (F9)
Sub-menu item General help
Menu items Last modified settings Goes back to EZ Mode
Displays the CPU temperature, CPU, and memory voltage output

Menu bar

The menu bar on top of the screen has the following main items:

My Favorites	For saving the frequently-used system settings and configuration.
Extreme Tweaker	For changing the overclocking settings
Main	For changing the basic system configuration
Advanced	For changing the advanced system settings
Monitor	For displaying the system temperature, power status, and changing the fan settings.
Boot	For changing the system boot configuration
Tool	For configuring options for special functions
Exit	For selecting the exit options and loading default settings

Menu items

The highlighted item on the menu bar displays the specific items for that menu. For example, selecting **Main** shows the Main menu items.

The other items (My Favorites, Extreme Tweaker, Advanced, Monitor, Boot, Tool, and Exit) on the menu bar have their respective menu items.

Submenu items

A greater than sign (>) before each item on any menu screen means that the item has a submenu. To display the submenu, select the item and press <Enter>.

Language

This button above the menu bar contains the languages that you can select for your BIOS. Click this button to select the language that you want to display in your BIOS screen.

MyFavorite(F3)

This button above the menu bar shows all BIOS items in a Tree Map setup. Select frequently-used BIOS settings and save it to MyFavorite menu.



Refer to section **My Favorites** for more information.

Qfan Control(F6)

This button above the menu bar displays the current settings of your fans. Use this button to manually tweak the fans to your desired settings.

EZ Tuning Wizard(F11)

This button above the menu bar allows you to view and tweak the overclocking settings of your system. It also allows you to change the motherboard's SATA mode from AHCI to RAID mode.

Quick Note (F9)

This button above the menu bar allows you to key in notes of the activities that you have done in BIOS.



- The quick Note function does not support the following keyboard functions: delete, cut, copy and paste.
- You can only use the alphanumeric characters to enter your notes.

Hot keys

This button above the menu bar contains the navigation keys for the BIOS setup program. Use the navigation keys to select items in the menu and change the settings.

Scroll bar

A scroll bar appears on the right side of a menu screen when there are items that do not fit on the screen. Press the Up/Down arrow keys or <Page Up> / <Page Down> keys to display the other items on the screen.

General help

At the top right corner of the menu screen is a brief description of the selected item. Use <F12> key to capture the BIOS screen and save it to the removable storage device.

Configuration fields

These fields show the values for the menu items. If an item is user-configurable, you can change the value of the field opposite the item. You cannot select an item that is not user-configurable.

A configurable field is highlighted when selected. To change the value of a field, select it and press <Enter> to display a list of options.

Last Modified button

This button shows the items that you last modified and saved in BIOS Setup.

3.3 My Favorites

My Favorites is your personal space where you can easily save and access your favorite BIOS items.

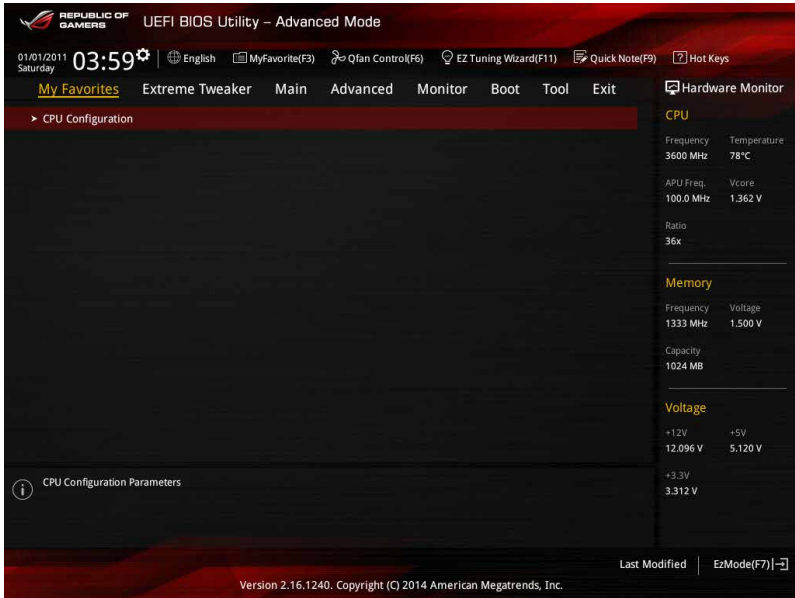

Adding items to My Favorites

To add frequently-used BIOS items to My Favorites:

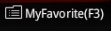
1. Press <F3> on your keyboard or click  to open Setup Tree Map screen.
2. On the Setup Tree Map screen, select the BIOS items that you want to save in My Favorites screen then click the plus sign (“+”) to save it in My Favorites screen.



You cannot add the following items to My Favorite items:

- Items with submenu options
- User-managed items such as language and boot order
- Configuration items such as Memory SPD Information, system time and date.

3.4 Extreme Tweaker menu

The Extreme Tweaker menu items allow you to configure overclocking-related items.



Be cautious when changing the settings of the Extreme Tweaker menu items. Incorrect field values can cause the system to malfunction.



The configuration options for this section vary depending on the CPU and DIMM model you installed on the motherboard.

Scroll down to display other BIOS items.

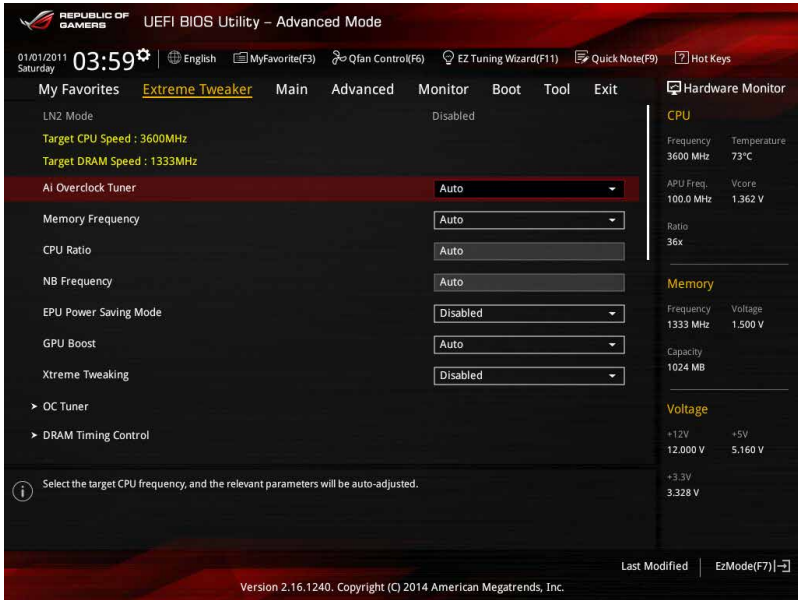

Ai Overclock Tuner [Auto]

Allows you to select the CPU overclocking options to achieve the desired CPU internal frequency. Configuration options:

- [Auto] Loads the optimal settings for the system.
- [Manual] Allows you to individually set overclocking parameters.
- [D.O.C.P.] CPU Bus, CPU ratio and memory parameters will be auto optimized.



- The [D.O.C.P.] option appears only when you install a memory module with XMP support.
- When the **Ai Overclock Tuner** is set to [Manual], the following items appear.

APU Frequency [100]

Allows you to adjust the APU frequency to enhance the system performance. Use the <+> and <-> keys to adjust the value. You can also key in the desired value using the numeric keypad. The values range from 90.0MHz to 300.0MHz.

Memory Frequency [Auto]

Allows you to set the memory operating frequency. The configuration options vary with the **APU Frequency** item settings. Configuration options: [Auto] [DDR3-800MHz] [DDR3-1066MHz] [DDR3-1333MHz] [DDR3-1600MHz] [DDR3-1866MHz] [DDR3-2133MHz] [DDR3-2400MHz]



Selecting a very high memory frequency may cause the system to become unstable! If this happens, revert to the default setting.

CPU Ratio [Auto]

Allows you to adjust non-turbo ratio. Use the <+> and <-> keys to adjust the value. You can also key in the desired value using the numeric keypad.

NB Frequency [Auto]

Allows you to adjust the NB frequency. Use the <+> and <-> keys to adjust the value. You can also key in the desired value using the numeric keypad.

EPU Power Saving Mode [Disabled]

Allows you to enable or disable the EPU power saving function. Configuration options: [Auto] [Light Power Saving Mode] [Medium Power Saving Mode] [Max Saving Mode]

GPU Boost [Auto]

- [Auto] Automatic configuration.
- [Turbo Mode] Set to [Turbo Mode] to achieve better 3D performance.
- [Extreme Mode] Set to [Extreme Mode] for the excellent visual experience.
- [Manual Mode] Set to [Manual Mode] if you want to manually select the desired GPU Engine frequency.

Xtreme Tweaking [Disabled]

This item may help improve some benchmarks performance. Configuration options: [Enabled] [Disabled]

OC Tuner

OC Tuner automatically overclocks the frequency and voltage of CPU and DRAM for enhancing the system performance. Configuration options: [OK] [Cancel]

DRAM Timing Control

The subitems in this menu allow you to set the DRAM timing control features. Use the <+> and <-> keys to adjust the value. To restore the default setting, type [auto] using the keyboard and press the <Enter> key.

Primary Timings

DRAM CAS# Latency [Auto]

Configuration options: [Auto] [5] – [16]

DRAM RAS# to CAS# Delay [Auto]

Configuration options: [Auto] [2] – [19]

DRAM RAS# PRE Time [Auto]

Configuration options: [Auto] [5] – [19]

DRAM RAS# ACT Time [Auto]

Configuration options: [Auto] [8] – [42]

DRAM COMMAND Mode [Auto]

Configuration options: [Auto] [1] – [2]

Secondary Timings

DRAM Row Cycle Time [Auto]

Configuration options: [Auto] [10] – [58]

DRAM READ to PRE Time [Auto]

Configuration options: [Auto] [4] – [12]

DRAM RAS# to RAS# Delay [Auto]

Configuration options: [Auto] [1] – [9]

DRAM WRITE to READ Delay [Auto]

Configuration options: [Auto] [4] – [12]

DRAM CAS# Write Latency [Auto]

Configuration options: [Auto] [5] – [17]

DRAM WRITE Recovery Time [Auto]

Configuration options: [Auto] [5 DRAM Clock] [6 DRAM Clock] [7 DRAM Clock] [8 DRAM Clock] [10 DRAM Clock] [12 DRAM Clock] [14 DRAM Clock] [16 DRAM Clock] [18 DRAM Clock]

DRAM FOUR ACT WIN Time [Auto]

Configuration options: [Auto] [6] [8] [10] [12] [14] – [44]

DRAM REF Cycle Time [Auto]

Configuration options: [Auto] [90ns] [110ns] [160ns] [300ns] [350ns]

Third Timings

CKE drive strength [Auto]

Configuration options: [Auto] [1.00x] [1.25x] [1.50x] [2.00x]

CS/ODT drive strength [Auto]

Configuration options: [Auto] [1.00x] [1.25x] [1.50x] [2.00x]

address/command drive strength [Auto]

Configuration options: [Auto] [1.00x] [1.25x] [1.50x] [2.00x]

MEMCLK drive strength [Auto]

Configuration options: [Auto] [1.00x] [1.25x] [1.50x] [2.00x]

Data drive strength [Auto]

Configuration options: [Auto] [0.75x] [1.00x] [1.25x] [1.50x]

DQS drive strength [Auto]

Configuration options: [Auto] [0.75x] [1.00x] [1.25x] [1.50x]

Processor on-die termination [Auto]

Configuration options: [Auto] [240 ohms +/- 20%] [120 ohms +/- 20%]
[80 ohms +/- 20%] [60 ohms +/- 20%]

CKE setup time [Auto]

Configuration options: [Auto] [1/2 MEMCLK DELAY] [1 MEMCLK DELAY]

CKE fine delay [Auto]

Configuration options: [Auto] [0]

CS/ODT setup time [Auto]

Configuration options: [Auto] [1/2 MEMCLK DELAY] [1 MEMCLK DELAY]

CS/ODT fine delay [Auto]

Configuration options: [Auto] [0]

address/command setup time [Auto]

Configuration options: [Auto] [1/2 MEMCLK DELAY] [1 MEMCLK DELAY]

address/command fine delay [Auto]

Configuration options: [Auto] [0]

GPU.DIMM Post

Automatically detects and displays the information about the devices or memory installed on the PCIe and DIMM slots. The field shows N/A if there are no devices installed on the slots.

DIGI+ Power Control**CPU Load Line Calibration [Auto]**

Load Line is defined by AMD® specification and affects CPU power voltage. The CPU working voltage decreases proportionally to CPU loading. Higher Load Line calibration could get higher voltage and good overclocking performance, but increases the CPU and VRM thermal conditions. This item allows you to adjust the voltage range from the following percentages to boost the system performance: 0% (Regular), 20% (Medium), 40% (High) and 100% (Extreme). Configuration options: [Auto] [Regular] [Medium] [High] [Extreme]



The actual performance boost may vary depending on your CPU specification.



DO NOT remove the thermal module. The thermal conditions should be monitored.

CPU/NB Load Line Calibration [Auto]

Allows you to select the CPU/NB Load Line Calibration mode. Configuration options: [Auto] [Regular] [Medium] [High] [Extreme]

CPU Current Capability [100%]

This item provides wider total power range for overclocking. A higher value brings a wider total power range and extends the overclocking frequency range simultaneously. Configuration options: [100%] [110%] [120%] [130%] [140%]

CPU/NB Current Capability [100%]

This item provides wider total power range for overclocking. A higher value brings a wider total power range and extends the overclocking frequency range simultaneously. Configuration options: [100%] [110%] [120%] [130%]

CPU Power Phase Control [Optimized]

Phase number is the number of working VRM phase. Increase the phase number under heavy system loading to get more transient and better thermal performance. Reduce the phase number under light system loading to increase VRM efficiency.

[Standard] Proceeds to phase control depending on the CPU loading.

[Optimized] Loads the ASUS optimized phase tuning profile.

[Extreme] Proceeds to the full phase mode.

[Manual Adjustment] Allows manual adjustment.

CPU Voltage Frequency [Auto]

Switching frequency will affect the VRM transient response and thermal condition. Setting a higher frequency gets a faster transient response.

[Auto] Allows you to enable or disable the Spread Spectrum item.

[Manual] Allows you to manually set the frequency with a 10k Hz interval.

VRM Spread Spectrum [Off]

This item appears only when you set the CPU Voltage Frequency item to [Auto] and allows you to enable the spread spectrum to enhance system stability.

CPU Power Duty Control [T.Probe]

[T.Probe] Maintains the VRM thermal balance.

[Extreme] Maintains the VRM current balance.

CPU Power Thermal Control [125]

A higher temperature brings a wider CPU power thermal range and extends the overclocking tolerance to enlarge the O.C. potential. Use the <+> and <-> keys to adjust the value. The values range from 125 to 135.

DRAM Current Capability [100%]

A higher value brings a wider total power range, and extends the overclocking range simultaneously. Configuration options: [100%] [110%] [120%] [130%]

DRAM Voltage Frequency [Auto]

Allows you to adjust the DRAM switching frequency. Assign a fixed high DRAM frequency to increase the O.C. range, or a low DRAM frequency for a better system stability. When this item is set to [Manual], DRAM Fixed Frequency Mode[300] appear Configuration options: [Auto] [Manual]

DRAM Power Phase Control [Optimized]

- [Optimized] Loads the ASUS optimized phase tuning profile.
- [Extreme] Proceeds to the full phase mode.

CPU Voltage [Offset Mode]

- [Manual Mode] Allows you to set a fixed CPU voltage.
- [Offset Mode] Allows you to set the Offset voltage.

CPU Offset Mode Sign [+]

This item appears only when you set the **CPU Voltage** item to [Offset Mode].

- [+] To offset the voltage by a positive value.
- [-] To offset the voltage by a negative value.

CPU Offset Voltage [Auto]

This item appears only when you set the **CPU Voltage** item to [Offset Mode] and allows you to set the Offset voltage. The values range from 0.00625V to 0.500V with a 0.00625V interval.

CPU Manual Voltage [Auto]

This item appears only when you set the **CPU Voltage** item to [Manual Mode] and allows you to set a fixed CPU voltage. The values range from 0.800V to 1.900V with a 0.00625V interval.



Refer to the CPU documentation before setting the CPU voltage. Setting a high voltage may damage the CPU permanently, and setting a low voltage may make the system unstable.

VDDNB Offset Mode Sign [+]

This item appears only when you set the **CPU Voltage** item to [Offset Mode].

- [+] To offset the voltage by a positive value.
- [-] To offset the voltage by a negative value.

VDDNB Offset Voltage [Auto]

This item appears only when you set the **CPU Voltage** item to [Offset Mode] and allows you to set the VDDNB Offset voltage. The values range from 0.00625V to 0.500V with a 0.00625V interval.

VDDNB Manual Voltage [Auto]

This item appears only when you set the **CPU Voltage** item to [Manual Mode] and allows you to set a fixed VDDNB voltage. The values range from 0.800V to 1.900V with a 0.00625V interval.

DRAM Voltage [Auto]

Allows you to set the DRAM voltage. The values range from 1.35V to 2.135V with a 0.005V interval.

SB 1.1V Voltage [Auto]

Allows you to set the Southbridge 1.1V voltage. The values range from 1.1V to 1.4V with a 0.01V interval.

1.1VSB Voltage [Auto]

Allows you to set the 1.1Vsb voltage. The values range from 1.1000V to 1.4000V with a 0.1V interval.

APU1.2V Voltage [Auto]

Allows you to set the APU (Accelerated Processor Unit) 1.2V voltage. The values range from 1.2000V to 1.8000V with a 0.01V interval.

VDDA Voltage [Auto]

Allows you to set the VDDA voltage. The values range from 2.5000V to 2.8000V with a 0.1V interval.

NB VREF Voltage [Auto]

Allows you to set the NB VREF voltage with a 0.005V interval.

DRAM VREFCA Voltage [Auto]

Allows you to set the DRAM VREFCA voltage with a 0.005V interval.

DRAM VREFDQ Voltage [Auto]

Allows you to set the DRAM VREFDQ voltage with a 0.005V interval.



-
- The values of the **CPU Offset Voltage**, **CPU Manual Voltage**, **VDDNB Offset Voltage**, **VDDNB Manual Voltage**, **DRAM Voltage**, **SB 1.1V Voltage**, **1.1VSB Voltage**, **APU1.2V Voltage**, **VDDA Voltage**, **NB VREF Voltage**, **DRAM VREFCA Voltage**, and **DRAM VREFDQ Voltage** items are labeled in a different color, indicating the risk levels of high voltage settings.
 - The system may need better cooling system to work stably under high voltage settings.
-

3.5 Main menu

The Main menu screen appears when you enter the Advanced Mode of the BIOS Setup program. The Main menu provides you an overview of the basic system information, and allows you to set the system language and security settings.

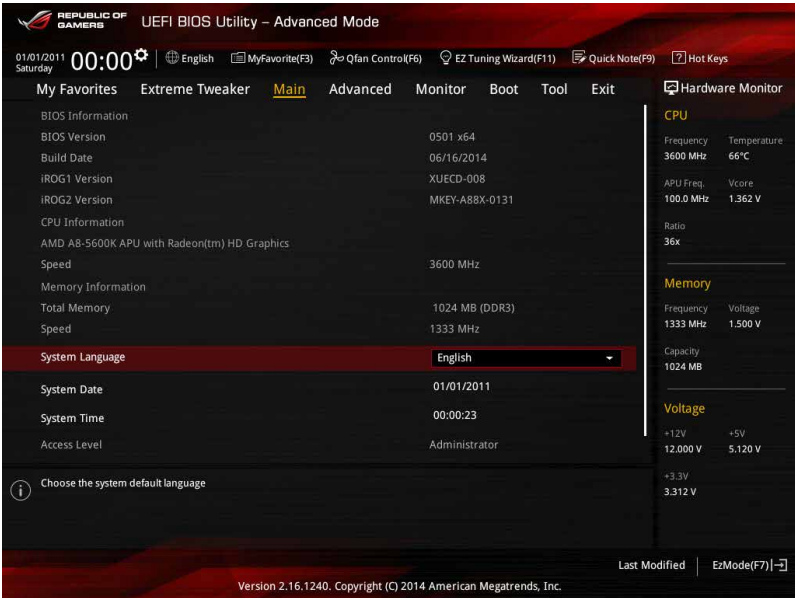

Security

The Security menu items allow you to change the system security settings.

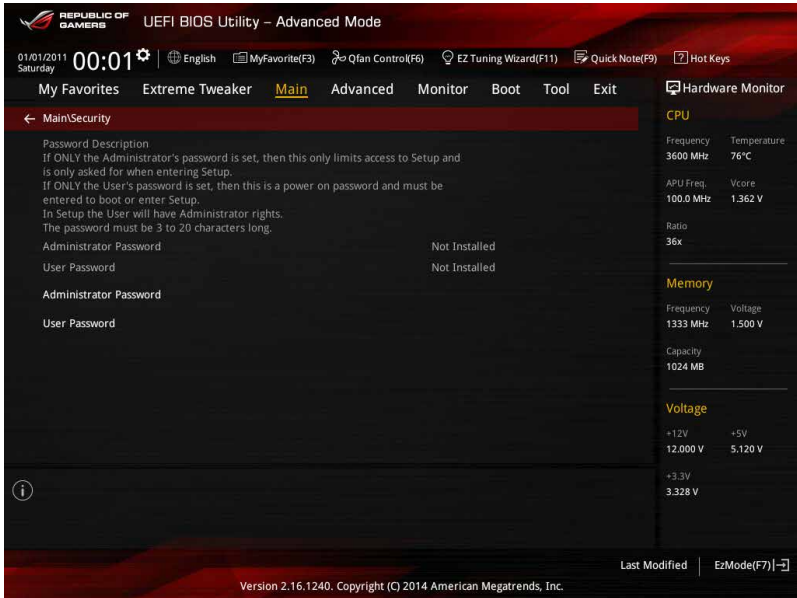

- If you have forgotten your BIOS password, erase the CMOS Real Time Clock (RTC) RAM to clear the BIOS password. See section 1.2.6 **Onboard buttons and switches** for information on how to erase the RTC RAM via the Clear CMOS button.
- The Administrator or User Password items on top of the screen show the default [Not Installed]. After you set a password, these items show [Installed].

Administrator Password

If you have set an administrator password, we recommend that you enter the administrator password for accessing the system. Otherwise, you might be able to see or change only selected fields in the BIOS setup program.

To set an administrator password:

1. Select the **Administrator Password** item and press <Enter>.
2. From the **Create New Password** box, key in a password, then press <Enter>.
3. Confirm the password when prompted.

To change an administrator password:

1. Select the **Administrator Password** item and press <Enter>.
2. From the **Enter Current Password** box, key in the current password, then press <Enter>.
3. From the **Create New Password** box, key in a new password, then press <Enter>.
4. Confirm the password when prompted.

To clear the administrator password, follow the same steps as in changing an administrator password, but press <Enter> when prompted to create/confirm the password. After you clear the password, the **Administrator Password** item on top of the screen shows **Not Installed**.

User Password

If you have set a user password, you must enter the user password for accessing the system. The User Password item on top of the screen shows the default Not Installed. After you set a password, this item shows Installed.

To set a user password:

1. Select the **User Password** item and press <Enter>.
2. From the **Create New Password** box, key in a password, then press <Enter>.
3. Confirm the password when prompted.

To change a user password:

1. Select the **User Password** item and press <Enter>.
2. From the **Enter Current Password** box, key in the current password, then press <Enter>.
3. From the **Create New Password** box, key in a new password, then press <Enter>.
4. Confirm the password when prompted.

To clear the user password, follow the same steps as in changing a user password, but press <Enter> when prompted to create/confirm the password. After you clear the password, the **User Password** item on top of the screen shows **Not Installed**.

3.6 Advanced menu

The Advanced menu items allow you to change the settings for the CPU and other system devices.



Be cautious when changing the settings of the Advanced menu items. Incorrect field values can cause the system to malfunction.

The screenshot displays the ROG UEFI BIOS Utility in Advanced Mode. The top bar includes the ROG logo, the title 'UEFI BIOS Utility – Advanced Mode', and a status bar with the date '01/01/2011 Saturday', time '00:05', and language 'English'. Below the status bar are navigation tabs: 'My Favorites', 'Extreme Tweaker', 'Main', 'Advanced' (selected), 'Monitor', 'Boot', 'Tool', and 'Exit'. A 'Hardware Monitor' icon is also present. The left sidebar lists configuration categories: CPU Configuration, SATA Configuration, USB Configuration, NB Configuration, Onboard Devices Configuration, APM, Network Stack, and ROG Effects. The right pane shows detailed hardware information:

- CPU**
 - Frequency: 3600 MHz
 - Temperature: 77°C
 - APU Freq.: 100.0 MHz
 - Vcore: 1.362 V
 - Ratio: 36x
- Memory**
 - Frequency: 1333 MHz
 - Voltage: 1.500 V
 - Capacity: 1024 MB
- Voltage**
 - +12V: +5V
 - 12.000 V: 5.120 V
 - +3.3V: 3.312 V

At the bottom of the screen, it says 'Version 2.16.1240. Copyright (C) 2014 American Megatrends, Inc.' and 'Last Modified | EzMode(F7) | -1'.

3.6.1 CPU Configuration

The items in this menu show the CPU-related information that the BIOS automatically detects.



The items in this menu may vary based on the CPU installed.

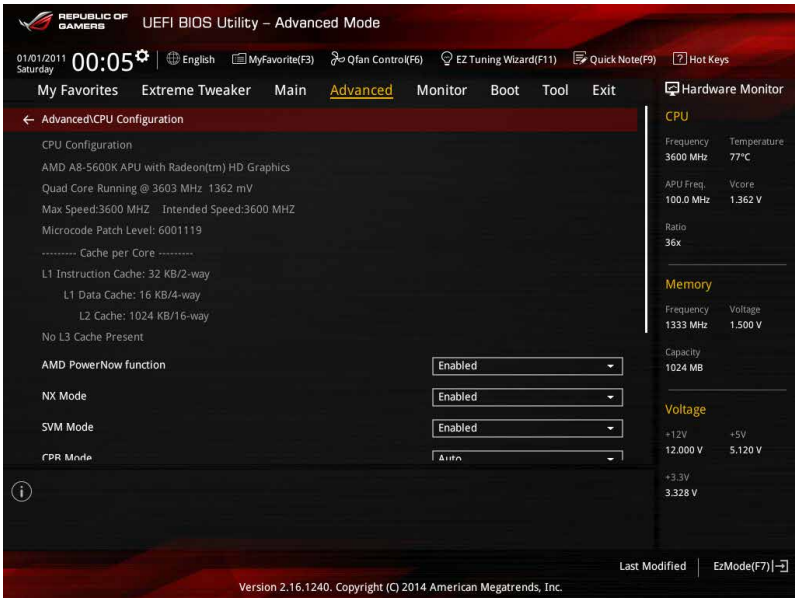

AMD PowerNow function [Enabled]

Enables or disables the AMD PowerNow function. Configuration options: [Enabled] [Disabled]

NX Mode [Enabled]

Enables or disables the No-execute page protection function. Configuration options: [Enabled] [Disabled]

SVM Mode [Enabled]

Allows you to enable or disable CPU virtualization. Configuration options: [Disabled] [Enabled]

CPB Mode [Auto]

Disables the CPB (Core Performance Boost) mode or set it to [Auto] for automatic configuration. Configuration options: [Disabled] [Auto]

APM Master enable [Auto]

Allows you to enable or disable Application Power Management (APM) function. Configuration options: [Auto] [Enabled] [Disabled]

C6 Mode [Enabled]

Enables or disables C6 mode. Configuration options: [Enabled] [Disabled]

IOMMU [Disabled]

Set this item to [Enabled] to show IOMMU Mode. Configuration options: [Enabled] [Disabled]

Bank Interleaving [Enabled]

Enables or disables the bank memory interleaving. Configuration options: [Enabled] [Disabled]

Channel Interleaving [Enabled]

Enables or disables the channel memory interleaving. Configuration options: [Enabled] [Disabled]

Core Leveling Mode [Automatic mode]

Allows you to change the number of working Compute Unit on the system. Configuration options: [Automatic mode] [One core per processor] [One Compute Unit] [One core per Compute Unit]

3.6.2 SATA Configuration

While entering Setup, the BIOS automatically detects the presence of SATA devices. The SATA Port items show **Not Present** if no SATA device is installed to the corresponding SATA port.

Scroll down to display the other BIOS items.

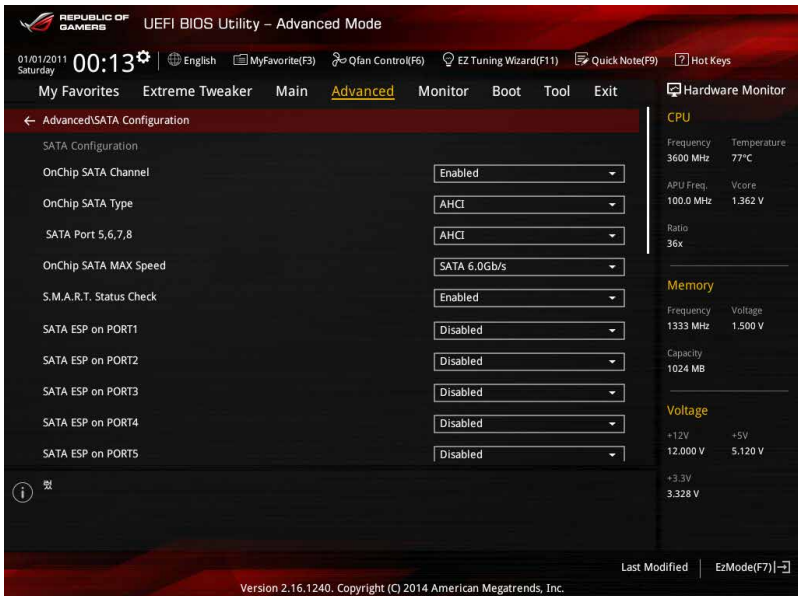

OnChip SATA Channel [Enabled]

Enables or disables onboard channel SATA port. Configuration options: [Disabled] [Enabled]

OnChip SATA Type [AHCI]

Allows you to set the SATA configuration.

- [IDE] Set to [IDE] when you want to use the Serial ATA hard disk drives as Parallel ATA physical storage devices.
- [RAID] Set to [RAID] when you want to create a RAID configuration from the SATA hard disk drives.
- [AHCI] Set to [AHCI] when you want the SATA hard disk drives to use the AHCI (Advanced Host Controller Interface). The AHCI allows the onboard storage driver to enable advanced Serial ATA features that increases storage performance on random workloads by allowing the drive to internally optimize the order of commands.

SATA Port 5, 6, 7, 8 [AHCI]

This item only appears when **OnChip SATA Type** is set to [AHCI]. If SATA ports 5, 6, 7 and 8 are configured as [AHCI], the ports can only be used under OS with driver installed. Set to [IDE] instead of [AHCI] to access devices on SATA ports 5, 6, 7 and 8 before entering OS. Configuration options: [AHCI] [IDE]

OnChip SATA MAX Speed [SATA 6.0Gb/s]

For better HDD compatibility, set the SATA speed to [SATA 3.0Gb/s] to support SATA 3.0Gb/s HDDs or [SATA 6.0Gb/s] to support SATA 6.0Gb/s HDDs. Configuration options: [SATA 6.0Gb/s] [SATA 3.0Gb/s]

S.M.A.R.T. Status Check [Enabled]

S.M.A.R.T. (Self-Monitoring, Analysis and Reporting Technology) is a monitoring system that shows a warning message during POST (Power-on Self Test) when an error occurs in the hard disks. Configuration options: [Disabled] [Enabled]

SATA ESP on Port1~8 [Disabled]

Enable this item to support ESATA. Configuration options: [Enabled] [Disabled]

SATA6G_1 (Red) - SATA6G_8 (Red)

Press <Enter> to rename the AMD SATA ports.

3.6.3 USB Configuration

The items in this menu allow you to change the USB-related features.

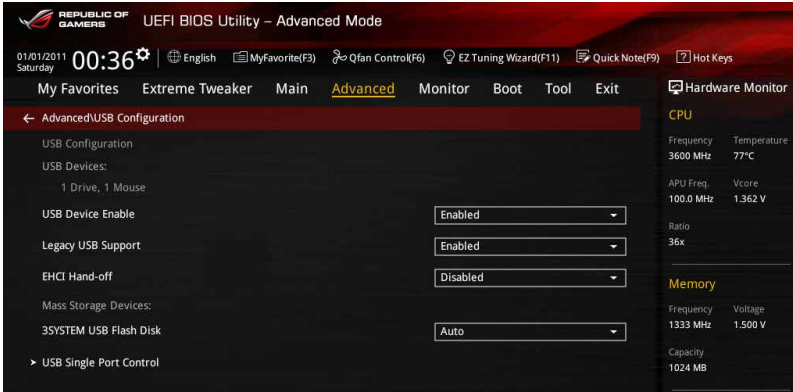

The **USB Devices** item shows the auto-detected values. If no USB device is detected, the item shows **None**.

USB Device Enable [Enabled]

Allows you to enable or disable all USB ports. Configuration options: [Disabled] [Enabled]

Legacy USB Support [Enabled]

[Disabled] The USB devices can be used only for the BIOS setup program. It cannot be recognized in boot devices list.

[Enabled] Enables the support for USB devices on legacy operating systems (OS).

[Auto] Allows the system to detect the presence of USB devices at startup. If detected, the USB controller legacy mode is enabled. If no USB device is detected, the legacy USB support is disabled.

EHCI Hand-off [Disabled]



This item is set to [Disabled] by default for the EHCI (enhanced host controller interface) support by EHCI drivers in operating systems.

[Disabled] Support EHCI by EHCI drivers for operating systems with EHCI support.

[Enabled] Support EHCI by BIOS for operating systems without EHCI support.

USB Single Port Control

Allows you to enable or disable the individual USB ports.



Refer to the **Motherboard layout** section for the location of the USB ports.

3.6.4 NB Configuration

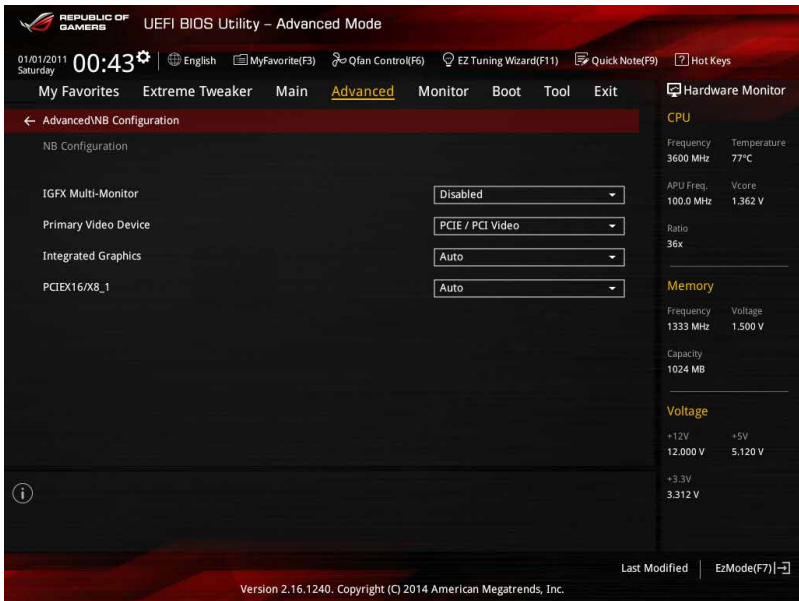

IGFX Multi-Monitor [Disabled]

Enables or disables the Internal Graphics Device Multi-Monitor support for add-on VGA devices. And the memory size of Internal Graphics Device will keep memory reserved. Configuration options: [Disabled] [Enabled]



The **IGFX Multi-Monitor** item must be enabled before using AMD® Dual Graphics technology.

Primary Video Device [PCIe / PCI Video]

Selects the primary display device. Configuration options: [IGFX Video] [PCIe / PCI Video]

Integrated Graphics [Auto]

Enables the integrated graphics controller. Configuration options: [Auto] [Force]

PCIEX16/X8_1 [Auto]

Sets the speed mode for the PCIe16_x1 slot. When [Force X16] is selected, the PCIe8_x2 slot will be disabled. Configuration options: [Auto] [Force X16] [Force X8]

3.6.5 Onboard Devices Configuration

Scroll down to view the other BIOS items.

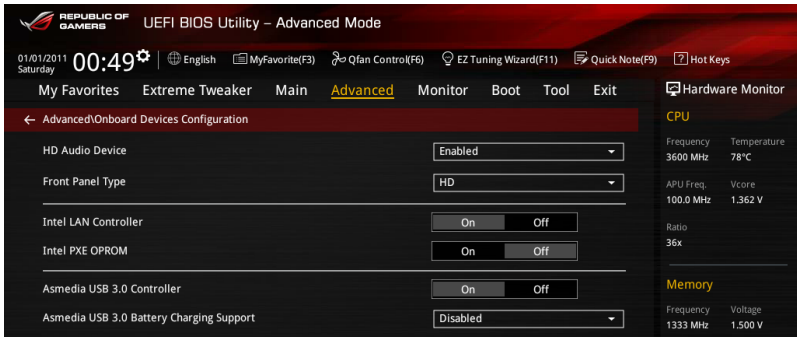

HD Audio Device [Enabled]

[Enabled] Enables the High Definition Audio Controller.

[Disabled] Disables the controller.



The following items appear only when you set the HD Audio Controller to **[Enabled]**.

Front Panel Type [HD]

[HD] Sets the front panel audio connector (AAFP) mode to high definition audio.

[AC97] Sets the front panel audio connector (AAFP) mode to legacy AC'97

Intel LAN Controller [On]

This item allows you to enable or disable the Intel LAN Controller. Configuration options: [On] [Off]

Intel PXE OPROM [Off]

This item appears only when Intel LAN Controller is set to **[On]**. This item allows you to enable or disable the Intel LAN preboot execution environment (PXE) option ROM. Configuration options: [On] [Off]

Asmedia USB 3.0 Controller [On]

[On] Enables the USB 3.0 controller.

[Off] Disables the controller.

Asmedia USB 3.0 Battery Charging Support [Disabled]

This item appears only when you set the previous item to [On] and allows you to enable or disable the ASmedia USB 3.0 Battery Charging Support.

[Enabled] Enables Asmedia USB 3.0 fast battery charging support for USB 3.0 devices complying with the BC 1.1 regulation.

[Disabled] Disables battery charging support.

3.6.6 APM Configuration

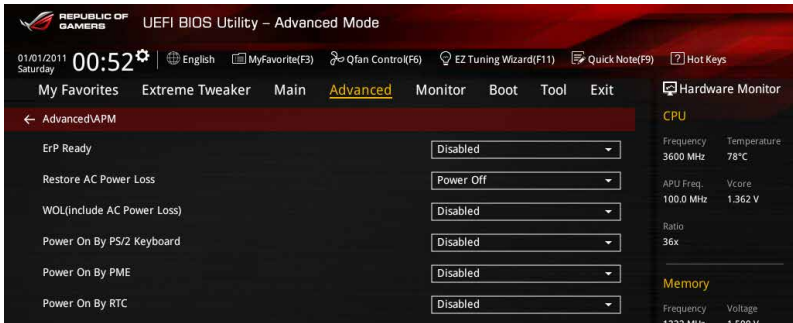

ErP Ready [Disabled]

Enable this item to optimize the power consumption at the S4 or S5 state to get the system ready for the ErP requirement. The system in deep S4 or deep S5 state can be only woken up via the power button. Configuration options: [Disabled] [Enabled(S4+S5)] [Enabled(S5)]

Restore AC Power Loss [Power Off]

[Power Off] The system goes into OFF state after an AC power loss.

[Power On] The system goes into ON state after an AC power loss.

[Last State] The system goes into either OFF or ON state, whatever the system state was before the AC power loss.

WOL (include AC Power Loss) [Disabled]

[Disabled] Disables Wake On LAN after a power failure (G3 state).

[Enabled] Enables Wake On LAN after a power failure (G3 state).

Power On By PME [Disabled]

[Disabled] Disables the PME to wake up by PCI/PCIE devices.

[Enabled] Allows you to turn on the system through a PCI/PCIE LAN or modem card. This feature requires an ATX power supply that provides at least 1A on the +5VSB lead.

Power On By RTC [Disabled]

[Disabled] Disables RTC to generate a wake event.

[Enabled] Generates a wake event and configure the real-time clock (RTC) alarm date.

3.6.7 Network Stack

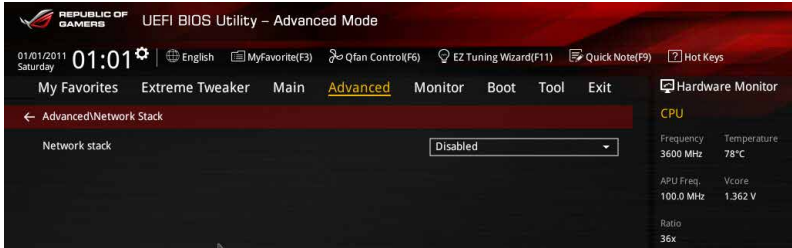

Network Stack [Disabled]

This item allows you to disable or enable the UEFI network stack. Configuration options: [Disabled] [Enabled]

3.6.8 ROG Effects

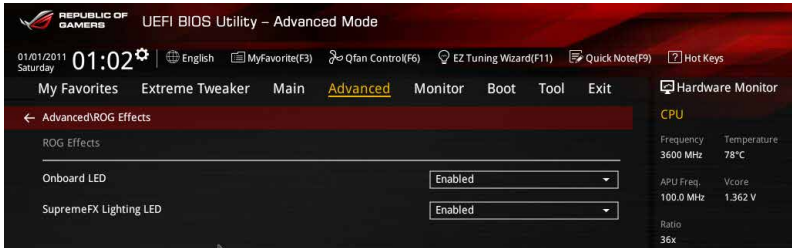

Onboard LED [Enabled]

This item allows you to enable all the onboard LEDs. Configuration options: [Enabled] [Disabled]

SupremeFX Lighting LED [Enabled]

This item allows both Red line LED and SupremeFX logo LED turn on or off at the same time by your setting. Configuration options: [Enabled] [Disabled]

3.7 Monitor menu

The Monitor menu displays the system temperature/power status, and allows you to change the fan settings.

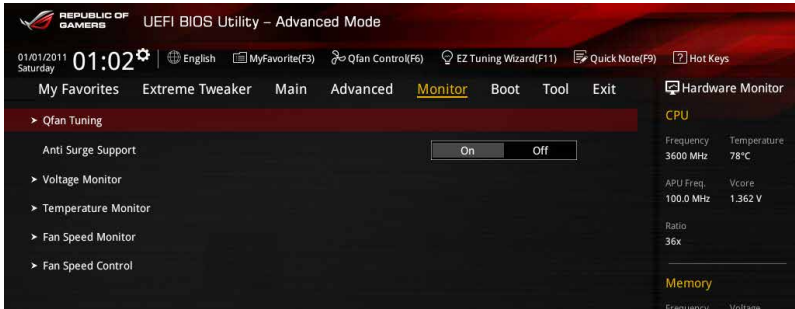

Qfan Tuning

Click this item to automatically detect the lowest speed and configure the minimum duty cycle for each fan.

Anti Surge Support [On]

Enable this item for Over Voltage Protection (OVP) and Under Voltage Protection (UVP) functions. Configuration options: [On] [Off]

Voltage Monitor

CPU Voltage; 3.3V Voltage; 5V Voltage; 12V Voltage

The onboard hardware monitor automatically detects the voltage output through the onboard voltage regulators. Press <Enter> and select [Ignore] if you do not wish to display the detected temperatures.

Temperature Monitor

CPU Temperature; MB Temperature

The onboard hardware monitor automatically detects and displays the CPU and motherboard. Press <Enter> and select [Ignore] if you do not wish to display the detected temperatures.

Fan Speed Monitor

CPU Fan Speed; CPU Optional Fan Speed; Chassis Fan 1-3 Speed

The onboard hardware monitor automatically detects and displays the CPU fan, chassis fan, and optional fan speed in rotations per minute (RPM). If any of the fans is not connected to the motherboard, the field shows [N/A]. These items are not user-configurable. Press <Enter> and select [Ignore] if you do not wish to display the detected temperatures.

Fan Speed Control

CPU Q-Fan Control [Auto]

- [Auto] Detects the type of CPU fan installed and automatically switches the mode control.
- [Disabled] Disables the Q-Fan control.
- [DC Mode] Enables the CPU Q-Fan control feature in DC mode for 3-pin CPU fan.
- [PWM Mode] Enables the CPU Q-Fan control feature in PWM mode for 4-pin CPU fan.



The following items appear only when you set the CPU Q-Fan Control to **[Auto]**.

CPU Fan Speed Lower Limit [200 RPM]

This item allows you to set the low limit warning for CPU Fan speed.

Configuration options: [Ignore] [100 RPM] [200 RPM] [300 RPM] [400 RPM] [500 RPM]

CPU Fan Profile [Standard]

This item allows you to set the appropriate performance level of the CPU fan.

- [Standard] Set to make the CPU fan adjust automatically depending on the CPU temperature.
- [Silent] Set to minimize the fan speed for quiet CPU fan operation.
- [Turbo] Set to achieve maximum CPU fan speed.
- [Manual] Set to assign the detailed fan speed control parameters.



The following items appear only when you set the CPU Fan Profile to **[Manual]**.

CPU Upper Temperature [70]

Use the <+> or <-> keys to adjust the upper limit of the CPU temperature. The values range from 25°C to 75°C.

CPU Fan Max. Duty Cycle (%) [100]

Use the <+> or <-> keys to adjust the maximum CPU fan duty cycle. The values range from 20% to 100%. When the CPU temperature reaches the upper limit, the CPU fan will operate at the maximum duty cycle.

CPU Middle Temperature [25]

Use the <+> or <-> keys to adjust the CPU middle temperature.

CPU Fan Middle. Duty Cycle (%) [20]

Use the <+> or <-> keys to adjust the maximum CPU fan duty cycle. The values range from 20% to 100%. When the CPU temperature reaches the upper limit, the CPU fan will operate at the maximum duty cycle.

CPU Lower Temperature [20]

Displays the lower limit of the CPU temperature.

CPU Fan Min. Duty Cycle(%) [20]

Use the <+> or <-> keys to adjust the minimum CPU fan duty cycle. The values range from 20% to 100%. When the CPU temperature is under 40°C, the CPU fan will operate at the minimum duty cycle.

Chassis Fan 1/2/3 Q-Fan Control [DC Mode]

- [Disabled] Disables the Chassis Q-Fan control feature.
- [DC Mode] Enable the chassis Q-Fan control in DC mode for 3-pin chassis fan.
- [PWM Mode] Enable the chassis Q-Fan control in PWM mode for 4-pin chassis fan.

Chassis Fan 1/2/3 Q-Fan Source [CPU]

The assignment fan will be controlled according to the selected temperature source. Configuration options: [CPU] [MB]

Chassis Fan 1/2/3 Fan Speed Low Limit [600 RPM]

This item appears only when you enable the **Chassis Q-Fan Control** feature and allows you to disable or set the chassis fan warning speed. Configuration options: [Ignore] [200 RPM] [300 RPM] [400 RPM] [500 RPM] [600 RPM]



The following items appears only when you set the Chassis Fan 1/2/3 Q-Fan Control feature to **[DC Mode]** or **[PWM Mode]**.

Chassis Fan 1/2/3 Profile [Standard]

This item allows you to set the appropriate performance level of the chassis fan.

- [Standard] Sets to [Standard] to make the chassis fan automatically adjust depending on the chassis temperature.
- [Silent] Sets to [Silent] to minimize the fan speed for quiet chassis fan operation.
- [Turbo] Sets to [Turbo] to achieve maximum chassis fan speed.
- [Manual] Sets to [Manual] to assign detailed fan speed control parameters.



The following items appear only when you set **Chassis Fan 1/2/3 Profile** to **[Manual]**.

Chassis Fan 1/2/3 Upper Temperature [70]

Use the <+> or <-> keys to adjust the upper limit of the CPU temperature. The values range from 45°C to 75°C.

Chassis Fan 1/2/3 Max. Duty Cycle (%) [100]

Use the <+> or <-> keys to adjust the maximum CPU fan duty cycle. The values range from 60% to 100%. When the CPU temperature reaches the upper limit, the CPU fan will operate at the maximum duty cycle.

Chassis Fan 1/2/3 Middle Temperature [45]

Use the <+> or <-> keys to adjust the Chassis Fan middle temperature.

Chassis Fan 1/2/3 Middle. Duty Cycle (%) [60]

Use the <+> or <-> keys to adjust the maximum CPU fan duty cycle. The values range from 60% to 100%. When the CPU temperature reaches the upper limit, the CPU fan will operate at the maximum duty cycle.

Chassis Fan 1/2/3 Lower Temperature [40]

Displays the lower limit of the CPU temperature.

Chassis Fan 1/2/3 Min. Duty Cycle(%) [60]

Use the <+> or <-> keys to adjust the minimum CPU fan duty cycle. The values range from 60% to 100%. When the CPU temperature is under 40°C, the CPU fan will operate at the minimum duty cycle.

Allow Fan Stop [Disabled]

When this item is set to [Enabled], the selected fan is controlled based on the temperature source.

3.8 Boot menu

The Boot menu items allow you to change the system boot options.

Scroll down to display the other BIOS items.

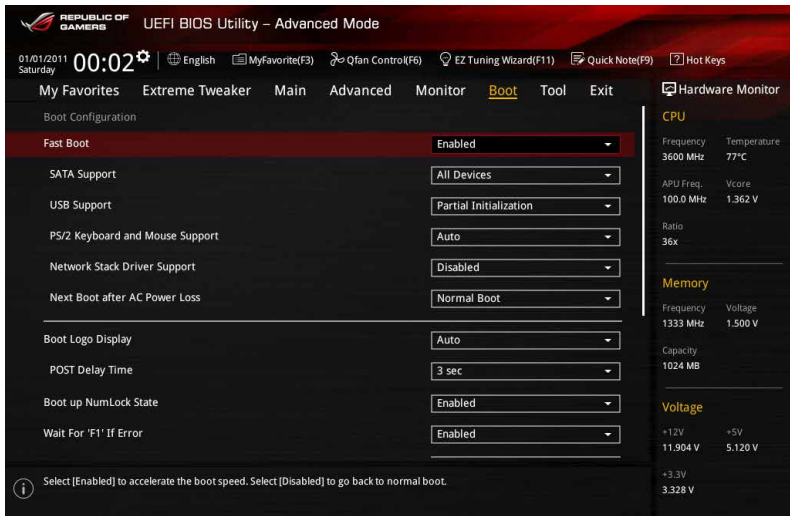

Fast Boot [Enabled]

[Disabled] Allows your system to go back to its normal boot speed.

[Enabled] Allows your system to accelerate the boot speed.



The following items appear only when you set the Fast Boot to **[Enabled]**.

SATA Support [All Devices]

[All Devices] All devices connected to SATA ports are available during POST. This process extends the POST time.

[Hard Drive Only] Only hard drives connected to SATA ports are detected during POST.

[Boot Drive Only] Only boot drives connected to a SATA ports are detected during POST.

USB Support [Partial Initialization]

- [Disabled] All USB devices will not be available until OS boot up for a fastest POST time.
- [Full Initialization] All USB devices will be available during POST. This process will extend the POST time.
- [Partial Initialization] For a faster POST time, only USB ports with keyboard and mouse connections will be detected.

PS/2 Keyboard and Mouse Support [Auto]

Allows you to disable or have full system control of the PS/2 devices' availability during POST. Configuration options: [Auto] [Disabled] [Full Initialization]

Network Stack Driver Support [Disabled]

- [Disabled] Select to skip the network stack driver from loading during POST.
- [Enabled] Select to load the network stack driver during POST.

Next Boot after AC Power Loss [Normal Boot]

- [Normal Boot] Returns to normal boot on the next boot after an AC power loss.
- [Fast Boot] Accelerates the boot speed on the next boot after an AC power loss.

Boot Logo Display [Auto]

- [Auto] Auto adjustments for Windows requirements.
- [Full Screen] Maximize the boot logo size.
- [Disabled] Hid the logo during POST.

Post Delay Time [3 sec]

This item This item allows you to select a desired additional POST waiting time to easily enter the BIOS Setup. You can only execute the POST delay time during normal boot. The values range from 0 to 10 seconds.



This feature only works when set under normal boot.

Boot up NumLock State [Enabled]

- [Enabled] Set the power-on state of the NumLock to [On].
- [Disabled] Set the power-on state of the NumLock to [Off].

Wait For 'F1' If Error [Enabled]

Enable this item for the system to pause until the F1 key is pressed when any error occurs. Configuration options: [Disabled] [Enabled]

DirectKey (DRCT) [Enabled]

- [Enabled] Allow the system to turn on and go to the BIOS setup directly when the reset button is pressed.
- [Disabled] The system will only turn on or off when the reset button is pressed.



You have to connect the 2-pin connector of the chassis reset button cable on the onboard DRCT header to support this function.

Option ROM Messages [Force BIOS]

- [Force BIOS] The Option ROM Messages will be shown during the POST.
- [Keep Current] Only the ASUS logo will be shown during the POST.

Interrupt 19 Capture [Enabled]

Enable this item to allow the option ROMs to trap the interrupt 19. Configuration options: [Enabled] [Disabled]

Setup Mode [Advanced Mode]

- [Advanced Mode] This item allows you to go to Advanced Mode of the BIOS after POST.
- [EZ Mode] This item allows you to go to EZ Mode of the BIOS after POST.

CSM (Compatibility Support Module)

This item allows you to configure the CSM (Compatibility Support Module) items to fully support the various VGA, bootable devices and add-on devices for better compatibility.

Launch CSM [Enabled]

- [Auto] The system automatically detects the bootable devices and the add-on devices.
- [Enabled] For better compatibility, enable the CSM to fully support the non-UEFI driver add-on devices or the Windows® UEFI mode.
- [Disabled] Disable the CSM to fully support the non-UEFI driver add-on devices or the Windows® UEFI mode.

The following items appear only when you set the Launch CSM to **[Enabled]**.

Boot Devices Control [UEFI and Legacy OPROM]

This item allows you to select the type of devices that you want to boot. Configuration options: [UEFI and Legacy OPROM] [Legacy OPROM only] [UEFI only]

Boot from Network Devices [Legacy OPROM first]

This item allows you to select the type of network devices that you want to launch. Configuration options: [Legacy OPROM first] [UEFI driver first] [Ignore]

Boot from Storage Devices [Legacy OPROM first]

This item allows you to select the type of storage devices that you want to launch. Configuration options: [Both, Legacy OPROM first] [Both, UEFI first] [Legacy OPROM first] [UEFI driver first] [Ignore]

Boot from PCIe/PCI Expansion Devices [Legacy OPROM first]

This item allows you to select the type of PCI-E/PCI expansion devices that you want to launch. Configuration options: [Legacy OPROM first] [UEFI driver first]

Secure Boot

This item allows you to configure the Windows® Secure Boot settings and manage its keys to protect the system from unauthorized access and malwares during POST.

OS Type [Windows UEFI mode]

- | | |
|---------------------|--|
| [Windows UEFI Mode] | This item allows you to select your installed operating system. Execute the Microsoft® Secure Boot check. Only select this option when booting on Windows® UEFI mode or other Microsoft® Secure Boot compliant OS. |
| [Other OS] | Get the optimized function when booting on Windows® non-UEFI mode. Microsoft® Secure Boot only supports Windows® UEFI mode. |

Key Management

Clear Secure Boot keys

This item appears only when you load the default Secure Boot keys. This item allows you to clear all default Secure Boot keys.

Save Secure Boot Keys

This item allows you to save the PK (Platform Keys) to a USB storage device.

PK Management

Delete PK

This item allows you to delete the PK from your system. Once the PK is deleted, all the system's Secure Boot keys will not be active.

Configuration options: [Yes] [No]

Load PK from File

This item allows you to load the downloaded PK from a USB storage device.



The PK file must be formatted as a UEFI variable structure with time-based authenticated variable.

KEK Management



Key-exchange Key (KEK) refers to Microsoft® Secure Boot Key-Enrollment Key (KEK).

Delete the KEK

Allows you to delete the KEK from your system.

Configuration options: [Yes] [No]

Load KEK from File

Allows you to load the downloaded KEK from a USB storage device.

Append KEK from File

Allows you to load the additional KEK from a storage device for an additional db and dbx loaded management.



The KEK file must be formatted as a UEFI variable structure with time-based authenticated variable.

DB Management

Delete the DB

Allows you to delete the DB file from your system.

Configuration options: [Yes] [No]

Load DB from File

Allows you to load the downloaded DB from a USB storage device.

Append DB from File

Allows you to load the additional DB from a storage device so that more images can be loaded securely.



The DB file must be formatted as a UEFI variable structure with time-based authenticated variable. DBX Management

DBX Management

Delete the DBX

Allows you to delete the DBX file from your system.

Load DBX from File

Allows you to load the downloaded DBX from a USB storage device.

Configuration options: [Yes] [No]

Append DBX from File

Allows you to load the additional DBX from a storage device so that more DB's images cannot be loaded.



The DBX file must be formatted as a UEFI variable structure with time-based authenticated variable.

Boot Option Priorities

These items specify the boot device priority sequence from the available devices. The number of device items that appears on the screen depends on the number of devices installed in the system.



-
- To access Windows® OS in Safe Mode, press <F8 > after POST (Windows® 8 not supported).
 - To select the boot device during system startup, press <F8> when ASUS Logo appears.
-

Boot Override

These items displays the available devices. The number of device items that appears on the screen depends on the number of devices installed in the system. Click an item to start booting from the selected device.

3.9 Tool menu

The Tools menu items allow you to configure options for special functions. Select an item then press <Enter> to display the submenu.

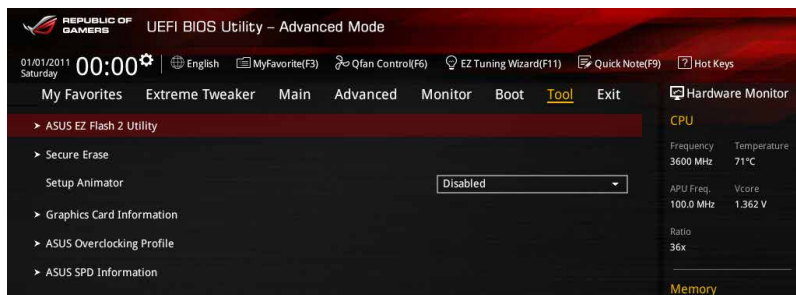

3.9.1 ASUS EZ Flash 2 Utility

Press <Enter> to run ASUS EZ Flash 2.



For more details, refer to section ASUS EZ Flash 2 utility.

3.9.2 Secure Erase

SSD speeds may lower over time as with any storage medium due to data processing. Secure Erase completely and safely cleans your SSD, restoring it to factory performance levels.



Secure Erase is only available in AHCI mode. Ensure to set the SATA mode to AHCI. Click **Advanced > SATA Configuration > AHCI**.

To launch ROG SSD Secure Erase, click **Tool > Secure Erase** on the Advanced mode menu.



Check the ASUS support site for a full list of SSDs tested with Secure Erase. The drive may become unstable if you run Secure Erase on an incompatible SSD.



- The time to erase the contents of your SSD may take a while depending on its size. Do not turn off the system during the process.
- Secure Erase is only supported on AMD SATA port. For more information about AMD SATA ports, refer to section 1.2.2 of this manual.

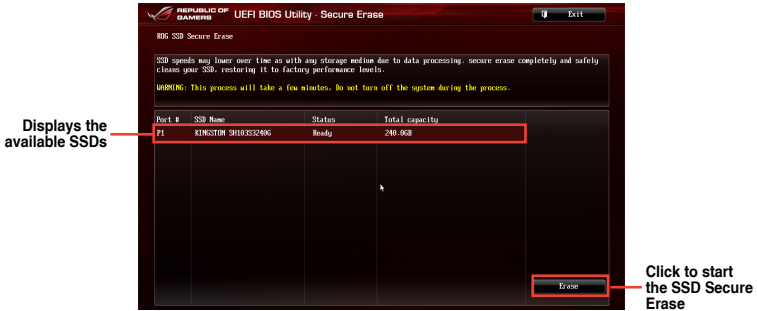

Status definition:

- **Frozen.** The frozen state is the result of a BIOS protective measure. The BIOS guards drives that do not have password protection by freezing them prior to booting. If the drive is frozen, a power off or hard reset of your PC must be performed to proceed with the Secure Erase.
- **Locked.** SSDs might be locked if the Secure Erase process is either incomplete or was stopped. This may be due to a third party software that uses a different password defined by ASUS. You have to unlock the SSD in the software before proceeding with Secure Erase.

3.9.3 Setup Animator [Disabled]

Enables or disables the Setup animator. Configuration options: [Disabled] [Enabled]

3.9.4 Graphics Card Information

This item displays the information about the graphics card installed in your system.

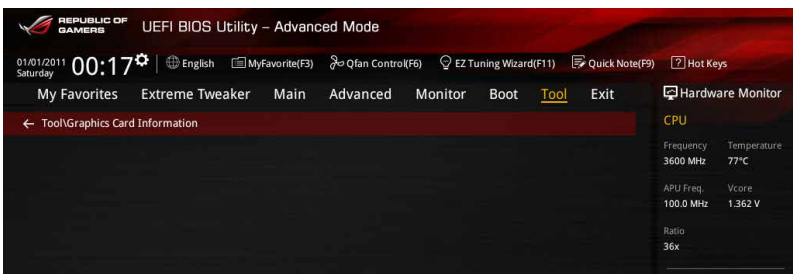

3.9.5 ASUS Overclocking Profile

This item allows you to store or load multiple BIOS settings.

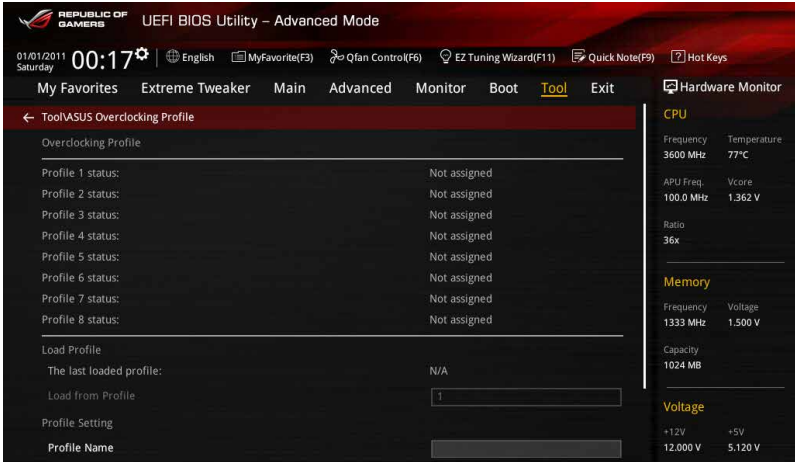

The **Overclocking Profile** items show **Not assigned** if no profile is created.

Load from Profile

Allows you to load the previous BIOS settings saved in the BIOS Flash. Key in the profile number that saved your CMOS settings, press <Enter>, and then select Yes.



- DO NOT shut down or reset the system while updating the BIOS to prevent the system boot failure!
- We recommend that you update the BIOS file only coming from the same memory/CPU configuration and BIOS version.

Profile Name

Key in the profile name to save current BIOS settings to profile 1 to 8.

Save to Profile

Saves the current BIOS settings to profile number 1 to 8.

Load/Save Profile from/to USB Drive

This item allows you to load or save profile from your USB drive, load and save profile to your USB drive.

3.9.6 ASUS SPD Information

Allows you to view the DRAM SPD information.

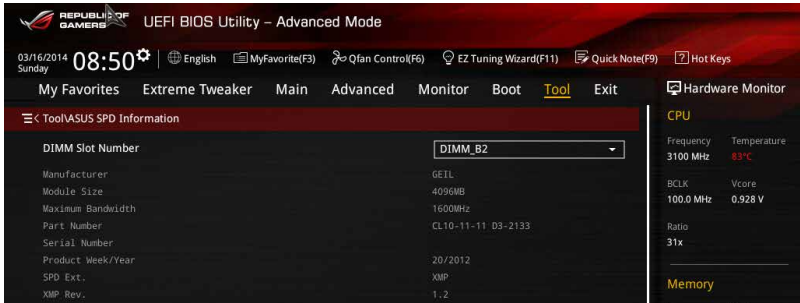

DIMM slot number [DIMM_A2]

Allows you to select the DIMM slot number to show the plugged DRAM Serial Presence Detect (SPD) information. Configuration options: [DIMM_A1] [DIMM_A2] [DIMM_B1] [DIMM_B2]



Some DRAM manufacturers may not be recognized.

3.10 Exit menu

The Exit menu items allow you to load the optimal default values for the BIOS items, and save or discard your changes to the BIOS items. You can access the EZ Mode from the Exit menu.

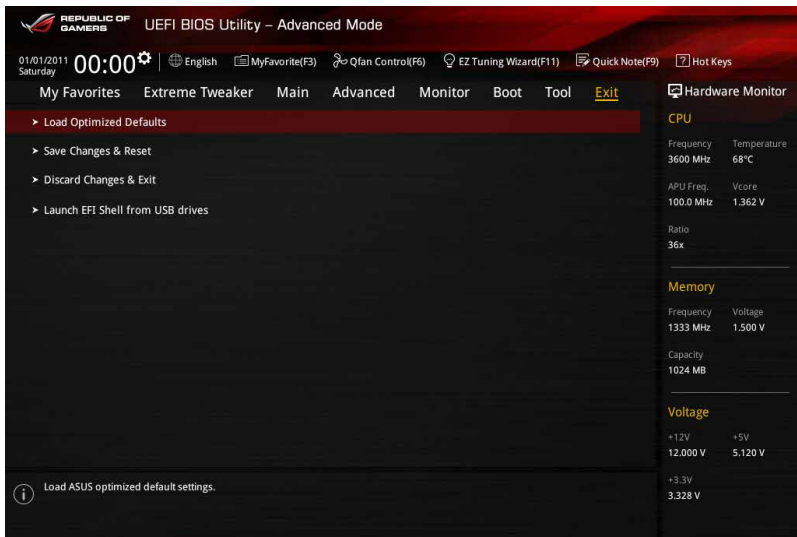

Load Optimized Defaults

This option allows you to load the default values for each of the parameters on the Setup menus. When you select this option or if you press <F5>, a confirmation window appears. Select Yes to load the default values.

Save Changes & Reset

Once you are finished making your selections, choose this option from the Exit menu to ensure the values you selected are saved. When you select this option or if you press <F10>, a confirmation window appears. Select **Yes** to save changes and exit.

Discard Changes & Exit

This option allows you to exit the Setup program without saving your changes. When you select this option or if you press <Esc>, a confirmation window appears. Select **Yes** to discard changes and exit.

Launch EFI Shell from USB drives

This option allows you to attempt to launch the EFI Shell application (shellx64.efi) from one of the available USB devices.

3.11 Updating BIOS

The ASUS website publishes the latest BIOS versions to provide enhancements on system stability, compatibility, and performance. However, BIOS updating is potentially risky. If there is no problem using the current version of BIOS, DO NOT manually update the BIOS. Inappropriate BIOS updating may result to system's failure to boot. Carefully follow the instructions in this chapter to update your BIOS when necessary.



Visit <http://www.asus.com> to download the latest BIOS file for this motherboard.

The following utilities allow you to manage and update the motherboard BIOS setup program.

1. EZ Update: Updates the BIOS in Windows® environment.
2. ASUS EZ Flash 2: Updates the BIOS using a USB flash drive.
3. ASUS CrashFree BIOS 3: Restores the BIOS using the motherboard support DVD or a USB flash drive when the BIOS file fails or gets corrupted.
4. ASUS BIOS Updater: Updates the BIOS in DOS environment using the motherboard support DVD and a USB flash disk drive.

3.11.1 EZ Update

The EZ Update is a utility that allows you to update the motherboard BIOS in Windows® environment.



- EZ Update requires an Internet connection either through a network or an ISP (Internet Service Provider).
 - This utility is available in the support DVD that comes with the motherboard package.
 - Refer to section **EZ Update** for more information.
-

3.11.2 ASUS EZ Flash 2

ASUS EZ Flash 2 allows you to update the BIOS without having to use a bootable floppy disk or an OS-based utility.



Before you start using this utility, download the latest BIOS from the ASUS website at www.asus.com.

To update the BIOS using EZ Flash 2:

1. Insert the USB flash disk that contains the latest BIOS file to the USB port.
2. Enter the Advanced Mode of the BIOS setup program. Go to the Tool menu to select ASUS EZ Flash 2 Utility and press <Enter> to enable it.

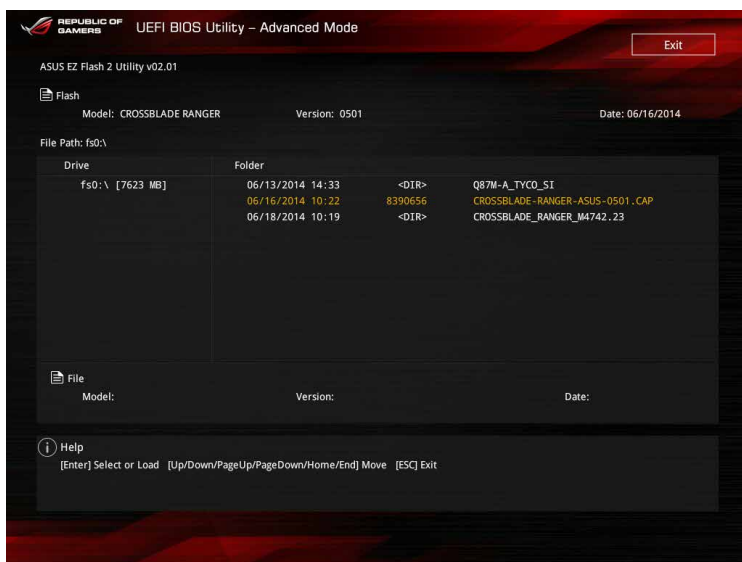

3. Press the Right/Left arrow keys to switch to the Drive field.
4. Press the Up/Down arrow keys to find the USB flash disk that contains the latest BIOS, and then press <Enter>.
5. Press the Right/Left arrow keys to switch to the Folder Info field.
6. Press the Up/Down arrow keys to find the BIOS file, and then press <Enter> to perform the BIOS update process. Reboot the system when the update process is done.



-
- This function can support devices such as a USB flash disk with FAT 32/16 format and single partition only.
 - DO NOT shut down or reset the system while updating the BIOS to prevent system boot failure!
-



Ensure to load the BIOS default settings to ensure system compatibility and stability. Select the Load Optimized Defaults item under the Exit menu. See section **3.10 Exit Menu** for details.

3.11.3 ASUS CrashFree BIOS 3

The ASUS CrashFree BIOS 3 utility is an auto recovery tool that allows you to restore the BIOS file when it fails or gets corrupted during the updating process. You can restore a corrupted BIOS file using the motherboard support DVD or a USB flash drive that contains the BIOS file.



The BIOS file in the motherboard support DVD may be older than the BIOS file published on the ASUS official website. If you want to use the newer BIOS file, download the file at <http://support.asus.com> and save it to a USB flash drive.

Recovering the BIOS

To recover the BIOS:

1. Turn on the system.
2. Insert the motherboard support DVD to the optical drive, or the USB flash drive containing the BIOS file to the USB port.
3. The utility automatically checks the devices for the BIOS file. When found, the utility reads the BIOS file and enters ASUS EZ Flash 2 automatically.
4. The system requires you to enter BIOS Setup to recover the BIOS setting. To ensure system compatibility and stability, we recommend that you press <F5> to load default BIOS values.



DO NOT shut down or reset the system while updating the BIOS! Doing so can cause system boot failure!

3.11.4 ASUS BIOS Updater

ASUS BIOS Updater allows you to update the BIOS in DOS environment.



The screen captures used in this section are for reference only and may not be exactly the same as actually shown on your computer screen.

Before updating BIOS

- Prepare the motherboard support DVD and a USB flash drive.
- Download the latest BIOS file and BIOS Updater from <http://support.asus.com> and save them in your USB flash drive.



NTFS is not supported under DOS environment. Ensure that your USB flash drive is in single partition and in FAT32/16 format.

- Turn off the computer.
- Ensure that your computer has a DVD optical drive.

Booting the system in DOS environment

To boot the system in DOS:

1. Insert the USB flash drive with the latest BIOS file and BIOS Updater to the USB port.
2. Boot your computer then press <F8> to launch the select boot device screen.
3. When the select boot device screen appears, insert the Support DVD into the optical drive then select the optical drive as the boot device.

Please select boot device:

↑ and ↓ to move selection
ENTER to select boot device
ESC to boot using defaults

P2: ST3808110AS (76319MB)
aigo miniking (250MB)
UEFI: (FAT) ASUS DRW-2014L1T(4458MB)
P1: ASUS DRW-2014L1T(4458MB)
UEFI: (FAT) aigo miniking (250MB)
Enter Setup

- When the booting message appears, press <Enter> within five (5) seconds to enter FreeDOS prompt.

```
ISOLINUX 3.20 2006-08-26 Copyright (C) 1994-2005 H. Peter Anvin
A Bootable DVD/CD is detected. Press ENTER to boot from the DVD/CD.
If no key is pressed within 5 seconds, the system will boot next priority
device automatically. boot:
```

- On the FreeDOS prompt, type **d:** then press <Enter> to switch the disk from Drive C (optical drive) to Drive D (USB flash drive).

```
Welcome to FreeDOS (http://www.freedos.org) !
C: /> d:
D: />
```

Updating the BIOS file

To update the BIOS file:

- On the FreeDOS prompt, type **bupdater /pc /g** and press <Enter>.

```
D: /> bupdater /pc /g
```

- On the BIOS Updater screen, press <Tab> to switch from Files panel to Drives panel then select **D:**.

ASUSTeK BIOS Updater for DOS V1.30 [2014/01/01]

Current ROM		Update ROM	
BOARD:	CROSSLDR KANGAR	BOARD:	Unknown
VER:	0501 (H :00 B :00)	VER:	Unknown
DATE:	06/16/2014	DATE:	Unknown

PATH: C:\

Drives panel	Files panel								
C: D:	<table border="1"> <thead> <tr> <th>FILENAME</th> <th>SIZE</th> <th>DATE</th> <th>TIME</th> </tr> </thead> <tbody> <tr> <td>CROSSLDR.CAP</td> <td>8390626</td> <td>2014-06-16</td> <td>21:14:34</td> </tr> </tbody> </table>	FILENAME	SIZE	DATE	TIME	CROSSLDR.CAP	8390626	2014-06-16	21:14:34
FILENAME	SIZE	DATE	TIME						
CROSSLDR.CAP	8390626	2014-06-16	21:14:34						

Note
 [Enter] Select or Load [Tab] Switch [V] Drive Info
 [Up/Down/Home/End] Move [Esc] Exit

- Press <Tab> to switch from Drives panel to Files panel then press <Up/Down or Home/End> keys to select the BIOS file and press <Enter>.

4. After the BIOS Updater checks the selected BIOS file, select **Yes** to confirm the BIOS update.



The BIOS Backup feature is not supported due to security regulations.

5. Select **Yes** then press <Enter>. When BIOS update is done, press <ESC> to exit BIOS Updater.
6. Restart your computer.



DO NOT shut down or reset the system while updating the BIOS to prevent system boot failure.



Ensure to load the BIOS default settings to ensure system compatibility and stability. Select the **Load Optimized Defaults** item under the **Exit** BIOS menu. See section **3.10 Exit menu** for details.

Software support

4

4.1 Installing an operating system



- This motherboard supports Windows® 7, Windows® 8, Windows® 8.1 32/64-bit operating systems (OS).
- Motherboard settings and hardware options vary. Use the setup procedures presented in this chapter for reference only. Refer to your OS documentation for detailed information.

4.2 Support DVD information



The contents of the support DVD are subject to change at any time without notice. Visit www.asus.com for updates.

4.2.1 Running the support DVD



Ensure that you have an Administrator account before running the support DVD in Windows® 7, Windows® 8, or Windows® 8.1 OS.

To run the support DVD:

1. Place the Support DVD into the optical drive.
2. In the **AutoPlay** dialog box, click **Run ASSETUP.exe**.

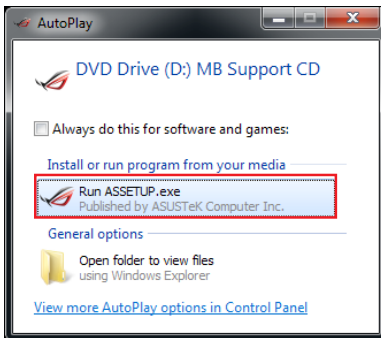

If the **AutoPlay** dialog box does not appear, browse the contents of the support DVD and double-click or tap `\\bin\ASSETUP.EXE` to launch the **ASUS motherboard support DVD** main menu.

Support DVD main menu

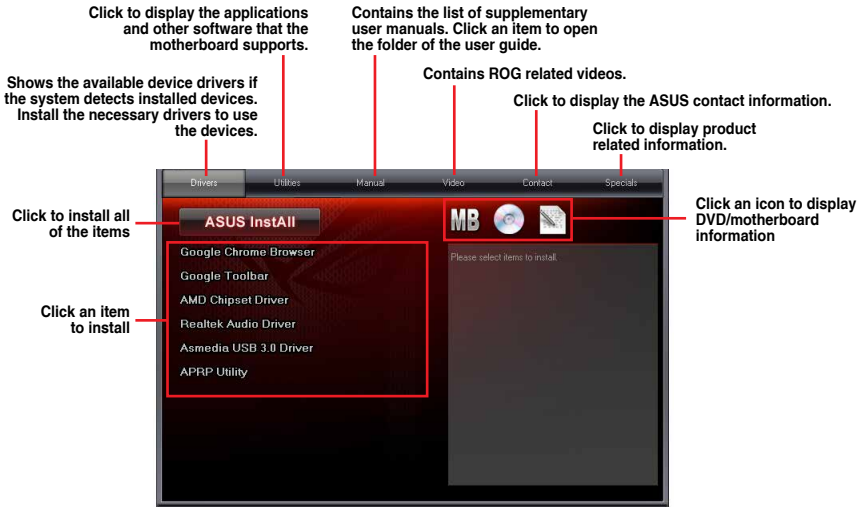

4.2.2 Obtaining the software manuals

The software manuals are included in the support DVD. Follow the instructions below to get the necessary software manuals.



The software manual files are in Portable Document Format (PDF). Install the Adobe® Acrobat® Reader from the **Utilities** tab before opening the files.

To read about your motherboard's utility guide:

1. Click **Manual** tab > **ASUS Motherboard Utility Guide**.



2. From the **Manual** folder, open the folder of the software manual that you wish to read.

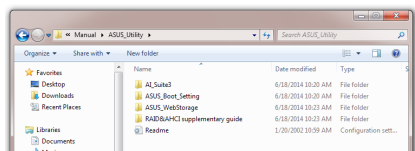

- Some software manuals are provided in different languages. Open the language's folder to view the software manual.

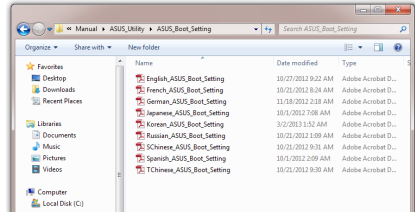

The screenshots in this section are for reference only. The actual software manuals containing in the support DVD vary by models.

4.3 Software information

Most of the applications in the support DVD have wizards that will conveniently guide you through the installation. View the online help or readme file that came with the software application for more information.

4.4 AI Suite 3

AI Suite 3 is an all-in-one interface that integrates several ASUS utilities and allows you to launch and operate these utilities simultaneously.

Installing AI Suite 3



Ensure that you have an Administrator account before installing AI Suite 3 in Windows® 7, Windows® 8, or Windows® 8.1 OS.

To install AI Suite 3 on your computer:

Windows® 7 OS

- Place the Support DVD into the optical drive.
- In the **AutoPlay** dialog box, click **Run ASSETUP.exe** then select the **Utilities** tab

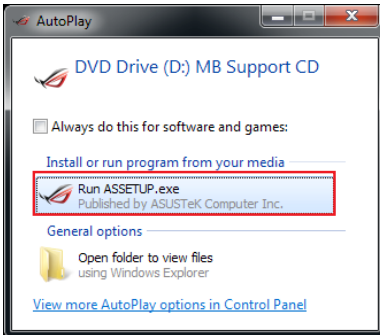

- From the **Utilities** tab, click **ASUS AI Suite 3** then follow the succeeding onscreen instructions.

Windows® 8 / Windows® 8.1 OS

1. Place the Support DVD into the optical drive then follow onscreen instructions.
2. From the **ASUS motherboard support DVD** main menu, select the **Utilities** tab and click **ASUS AI Suite 3**.
3. Follow the succeeding onscreen instructions.

If the **ASUS motherboard support DVD** main menu did not appear, try the following steps:

- a. Go to the **Start Screen** then click or tap the **Desktop** app.
- b. On the lower left corner of the Desktop, click or tap **File Explorer**  then select your DVD drive and tap or double-click the **Setup** application.

Launching AI Suite 3

Windows® 7 OS

From the Desktop, click **Start > All Programs > ASUS > AI Suite 3 > AI Suite 3**.

You can also launch AI Suite 3 in Windows® 7 by clicking  on the Notification area.

Windows® 8 / Windows® 8.1 OS

To launch AI Suite 3 in Windows® 8, tap the **AI Suite 3** app on the Start Screen (or if you're using a mouse, click the **AI Suite 3** app on the Start screen).



AI Suite 3 Main menu

The AI Suite 3 main menu gives you easy-access controls and insight to what's going on with your computer - allowing you to optimize performance settings while at the same time ensuring system stability.

The AI Suite main menu includes a quick-access menu bar that allows you to swiftly launch any of the integrated ASUS utilities. Click or tap  on the top-right corner of the menu to launch the menu bar.



The AI Suite 3 screenshots in this section are for reference only and can vary depending on motherboard model..

Click to launch AI Suite 3 menu bar

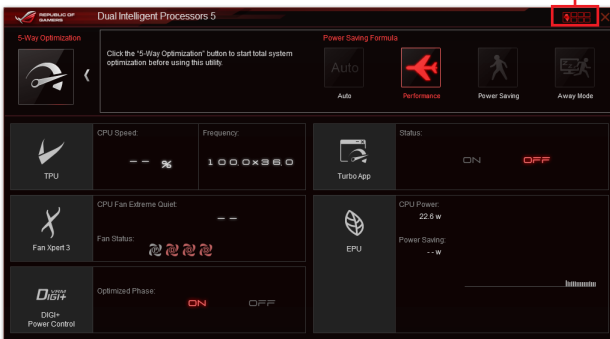

AI Suite 3 main menu bar

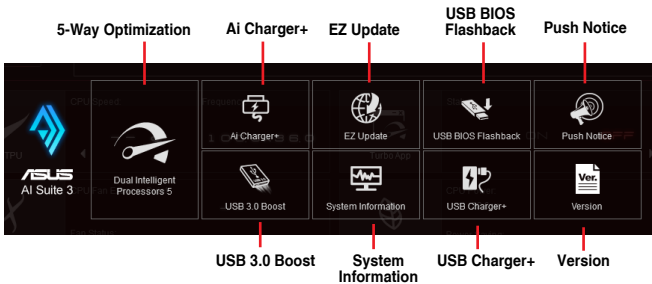

- Some functions in the AI Suite 3 main menu in this user guide may vary depending on the motherboard model.
- Refer to the software manual in the support DVD or visit the ASUS website at www.asus.com for detailed software configuration.

4.5 Dual Intelligent Processors 5

ASUS Dual Intelligent Processors 5 combines TPU, EPU, DIGI+ Power Control, Fan Xpert 3, and Turbo App functions to push the system's performance to its optimal potential. It automatically balances the system's performance, power saving, levels, and fan settings via the user-friendly AI Suite 3 utility.

5-Way Optimization

The 5-Way Optimization function dynamically optimizes your PC based on real-time usage to provide the best system status. It covers the essential areas such as CPU performance, energy saving, stable digital power, cool and quiet fan control, and includes tailored settings for your apps to ensure your PC is ready for gaming, entertainment, productivity, or just about anything.

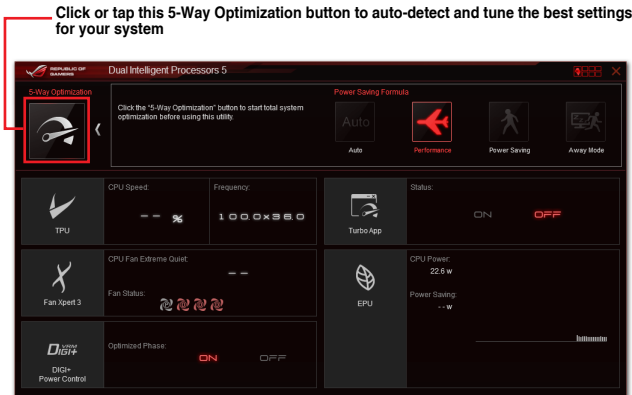

DO NOT remove your fan during the tuning process.

Turbo Processing Unit (TPU)

TPU allows you to manually adjust the CPU frequency and related voltages for an enhanced system stability and a performance boost.



Refer to the CPU documentation before adjusting CPU voltage settings. Setting a high voltage may damage the CPU permanently, and setting a low voltage may lead to an unstable system.



For system stability, the TPU settings are not saved in the BIOS and are not loaded during system bootup. Save your overclocking settings as a TPU profile and manually load this profile after system bootup.

Using TPU

CPU Frequency

Click or tap ◀ or ▶ to adjust the APU Frequency and CPU Ratio

Click or tap ◀ or ▶ to adjust the voltages

Click or tap to load the saved profile

Click or tap to save the adjustment into a profile

Click or tap to undo the adjustments

Click or tap to apply the adjustments

Fan Xpert 3

ASUS Fan Xpert 3 provides customizable settings of your fans for a cooler and more quiet computing environment. With its fan Auto Tuning feature, ASUS Fan Xpert 3 automatically tweaks the settings of CPU and chassis fans to achieve their best cooling performance. ASUS Fan Xpert 3 also supports hardware level PWM/DC combo mode for the CPU and chassis fans. You can also reduce the CPU fan speed below the default minimum for a noiseless operation during light loads.

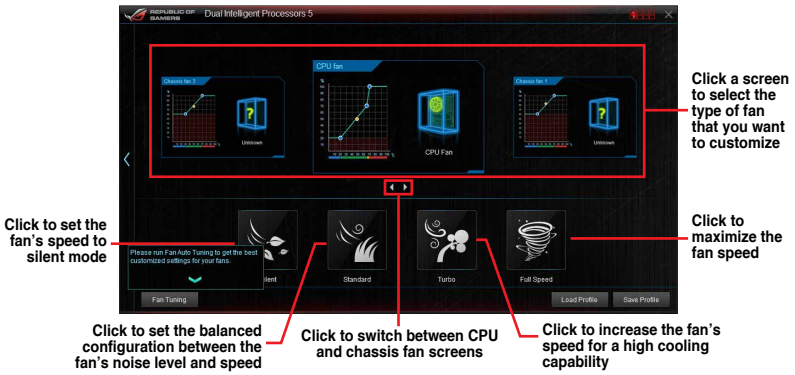

DIGI+ Power Control

ASUS DIGI+ Power Control features the revolutionary and innovative digital VRM and DRAM Voltage controllers. These controllers offers ultra-precise memory and voltage tuning for optimal system efficiency, stability and performance.



The following screens are for reference only. Configuration options varies depending on the motherboard model.

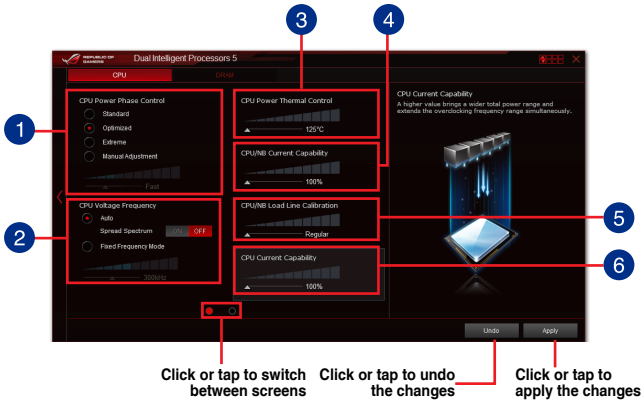

- 1 CPU Power Phase Control**
Increase the phase number under a heavy system load to get more transient and better thermal performance. Reduce the phase number under a light system load to increase the VRM efficiency.
- 2 CPU Voltage Frequency**
Enables spread spectrum to enhance system stability.
- 3 CPU Power Thermal Control**
A higher temperature brings a wider CPU power thermal range and extends the overclocking tolerance to enlarge the overclocking potential.
- 4 CPU/NB Current Capability**
CPU Current Capability provides a wider total power range for overclocking. A higher value brings a wider total power range and extends the overclocking frequency range simultaneously.
- 5 CPU/NB Load-line Calibration**
CPU/NB Load-line controls the behavior of the DRAM controller. Adjust to a high value for better system performance or to a low value for a better power efficiency.
- 6 CPU Current Capability**
A higher value brings a wider total power range and extends the overclocking frequency range simultaneously.

Turbo App

Turbo App allows you customize the system performance, network priority, and audio setting of an application.

When an application is on the Turbo App List, you can allocate the CPU frequency, assign a network priority, and define the audio setting of the selected application.

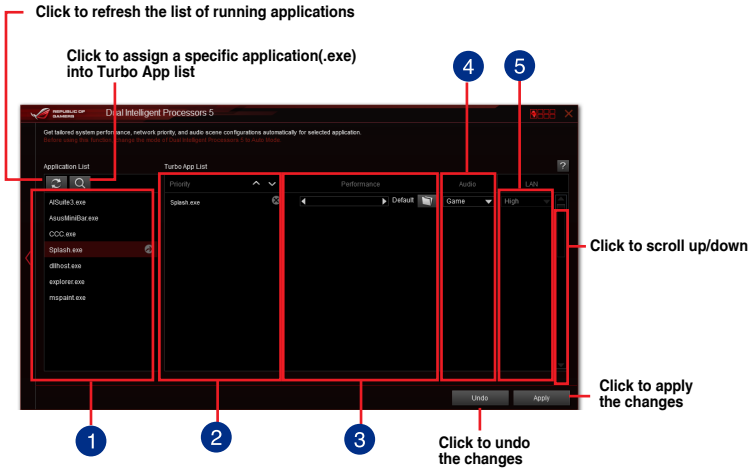

- 1 **Applications list pane**
Displays all the running applications on your system.
- 2 **Turbo App List pane**
Displays the applications added to the Turbo App List.
- * Only applications on the Turbo App List can be configured.
- 3 **Performance pane**
Allows you to assign the CPU performance to a selected application.
- 4 **Audio pane**
Allows you to manually assign a preset audio configuration to a selected application.
- 5 **LAN pane**
Allows you assign the network priority to a selected application.

Energy Processing Unit (EPU)

EPU is a real-time system power-saving chip that automatically detects the current system load and intelligently moderates power usage. It offers a total system-wide energy optimization, reduces fan noise, and extends the lifespan of your hardware components.

Using EPU

Click to configure the settings in Auto mode

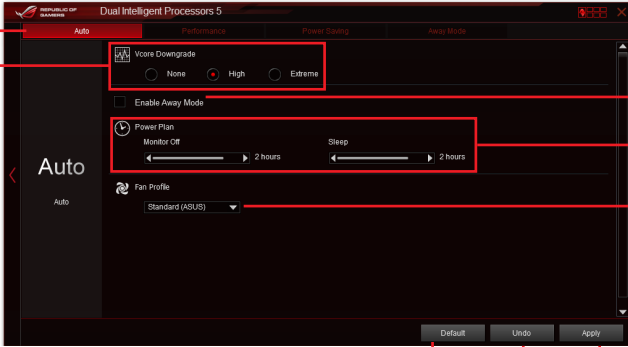

Tick to enable Away Mode

Click ◀ or ▶ to set the power plan

Click ▼ to select a fan profile

Select a setting for Vcore Downgrade

Click to enable the default settings

Click to undo the adjustments

Click to apply the adjustments

USB 3.0 Boost

USB 3.0 Boost technology supports UASP (USB Attached SCSI Protocol) that automatically speeds up the transfer rates of your USB storage devices.

Launching USB 3.0 Boost

To launch USB 3.0 Boost, click or tap  on the top-right corner of the AI Suite 3 main menu, then select **USB 3.0 Boost**.

Using the USB 3.0 Boost

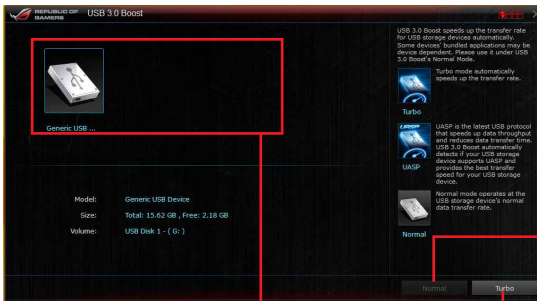

Click to select a USB device

Click to enable the USB device's normal data transfer rate

Click to enable UASP or Turbo Mode to the USB device for a faster data transfer rate



Ensure to connect your USB 3.0 device to the USB 3.0 ports that support USB 3.0 Boost. Refer to the **Rear I/O connection section** of your user guide for more details.



- USB 3.0 Boost automatically detects the USB 3.0 devices that support UASP. For a list of UASP-supported USB 3.0 devices, visit the ASUS website at www.asus.com.
- The data transfer speed varies with USB devices. For a higher data transfer performance, use a USB 3.0 device.

Ai Charger+

This utility allows you to fast-charge your portable BC 1.1* mobile devices on your computer's USB port three times faster than the standard USB devices**.



- * Check your manufacturer if your USB device is a Battery Charging Specification 1.1 (BC 1.1) compliant or compatible device.
- ** Actual charging speeds may vary depending on the charging rate and specifications of your USB device.
- To ensure normal charging function, disconnect and reconnect your USB device every time you enable or disable Ai Charger+.



EZ Update

EZ Update is a utility that allows you to automatically update your motherboard's software, drivers, or BIOS.

With this utility, you can also manually update the BIOS and select the boot logo that will display during POST.

Launching EZ Update

To launch EZ Update, click or tap  on the top-right corner of the AI Suite 3 main menu, then click **EZ Update** on the AI Suite 3 main menu bar.

EZ Update screen

Click to automatically update your motherboard's driver, software and firmware

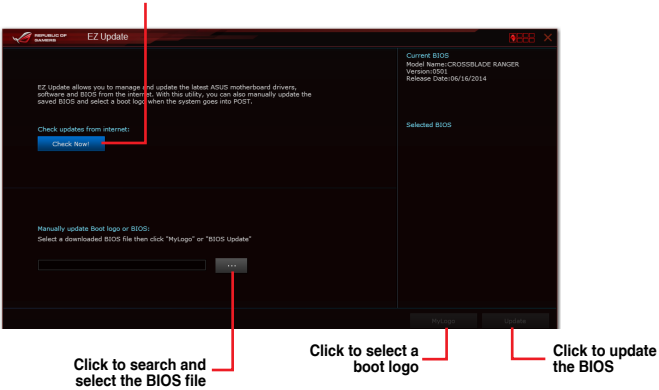

System Information

This utility displays the detailed information and settings of the installed motherboard, CPU, and memory.

Launching the System Information

To launch System Information, click or tap  on the top-right corner of the AI Suite 3 main menu, then select **System Information**.

Viewing the motherboard information

Click or tap the **MB** tab to view the motherboard's information.

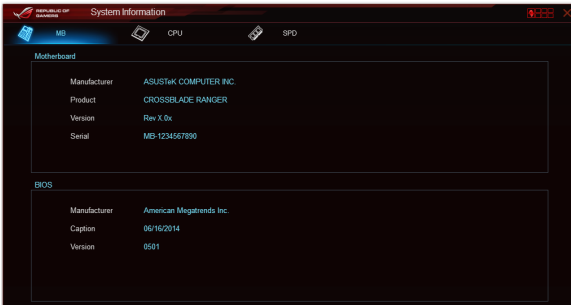

Viewing the CPU information

Click or tap the **CPU** tab to view the processor's information.



Viewing the SPD information

Click or tap the **SPD** tab to view the memory's information.



USB BIOS Flashback

USB BIOS Flashback allows you to check and save the latest BIOS version to a USB storage device. Use this utility to quickly check for the latest available BIOS and set the BIOS download schedule.

Launching USB BIOS Flashback

To launch USB BIOS Flashback, click or tap  on the top-right corner of the AI Suite 3 main menu, then select **USB BIOS Flashback**.



USB BIOS Flashback is available only in selected motherboard models.

Using USB BIOS Flashback

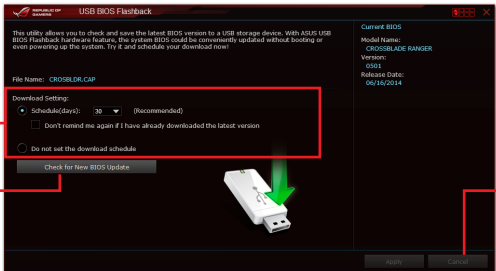

Set a schedule for the BIOS Update download

Click to check for a new BIOS update available for download

Click or tap to cancel the download schedule setting

Click or tap to apply the download schedule setting

Scheduling the BIOS download

1. In the Download Setting field, tick **Schedule (days)** then select the number of days for the BIOS download schedule.
2. Click or tap **Apply** to save the BIOS download schedule. Click or tap **Cancel** to cancel the download schedule.

USB Charger+

USB Charger+ allows you to quick-charge your portable USB devices even if your computer is off, in sleep mode, or in hibernate mode.



Before using USB Charger+, ensure to disable the ErP Ready item in the BIOS. To do this, go to **Advanced > APM > ErP Ready** in the Advanced mode then set this item to [Disabled].



USB Charger+ is available only in selected motherboard models.

Launching USB Charger+

To launch USB Charger+, click or tap  on the top-right corner of the AI Suite 3 main menu, then select **USB Charger+**.

Using USB Charger+

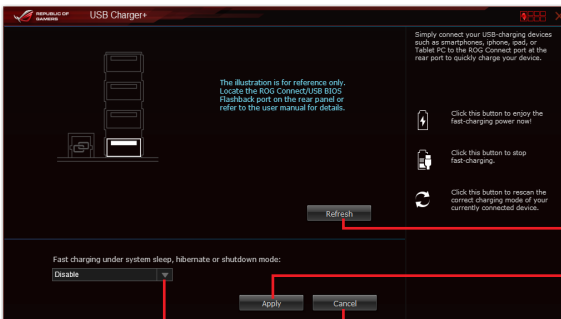

Click or tap to refresh the list

Click or tap to apply the settings

Click or tap to discard the settings

Click or tap to select the type of USB device that you wish to charge when the system is off



Ensure to connect your USB device into the USB port that supports this utility. Refer to section **2.3.1 Rear I/O connection** of your user manual for more details.



- USB Charger+ does not support USB hubs, USB extension cables, and generic USB cables.
- USB Charger+ may not recognize some ASUS devices due to varying design.

Push Notice

This utility allows you get the detailed status of your system to your smart device. You can also send messages to your smart device using this utility.



Before using this utility, ensure that you pair your computer with your smart device. For pairing information, refer to section **Pairing your computer and smart device**.

Launching Push Notice on your computer



To launch Push Notice, click or tap  on the top-right corner of the AI Suite 3 main menu, then select **Push Notice**.

Push Notice screen



The screenshot shows the Push Notice utility window with three columns: PC Mode Alerts, PC Status Alerts, and Message. Each column has settings for function, day, time, and alert message. Annotations include: 'Click or tap to enable Push Notice' pointing to the top-right corner; 'Tick to select the smart device' pointing to the 'Select all' checkbox; 'Click or tap to discard the settings' pointing to the 'Undo' button; and 'Click or tap to apply the settings' pointing to the 'Apply' button.



You can also enable the Push Notice via the Push Notice shortcut on the lower-right corner of your screen. To do this, click or tap << then click or tap  then select .

Pairing your computer and smart device

To pair your computer and smart device:

1. On your smart device, tap  to launch Push Notice.
2. Tap **Push Scan** then tap the name of your computer that you want to pair with.



To pair your computer and smart device, ensure that both are connected to the same wireless network.

Setting up PC Mode alerts of your computer

This feature allows you to restart, shut down, or put your computer to sleep mode and sends an alert to your smart device.

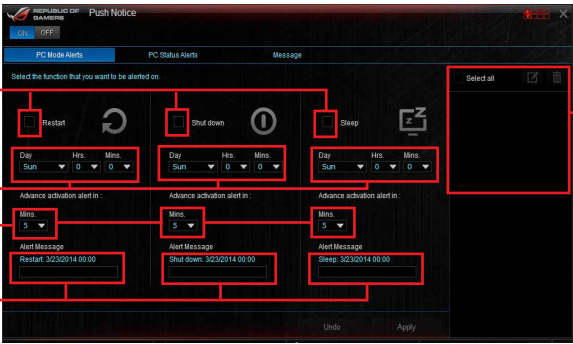

The screenshot shows the 'Push Notice' application interface for configuring 'PC Mode Alerts'. The window title is 'Push Notice' and it has a 'Push Notice' logo in the top left. The main title bar says 'PC Mode Alerts'. Below the title bar, there are three tabs: 'PC Mode Alerts', 'PC Status Alerts', and 'Message'. The 'PC Mode Alerts' tab is active. The interface is divided into three columns, each representing a different PC mode: Restart, Shut down, and Sleep. Each column has a corresponding icon and a 'Select' checkbox. Below each mode, there are three dropdown menus for 'Day', 'Hrs.', and 'Mins.' to set the time for the alert. There is also a 'Mins.' dropdown for 'Advance activation alert in:'. At the bottom of each column, there is a text box for 'Alert Message'. On the right side, there is a 'Message' section with a 'Select all' button and a trash icon. At the bottom of the window, there are 'Undo' and 'Apply' buttons. Red boxes and arrows point to various elements with the following annotations:

- Tick these to enable mode alerts**: Points to the 'Select' checkboxes for Restart, Shut down, and Sleep.
- Set the day and time to enable the PC modes**: Points to the 'Day', 'Hrs.', and 'Mins.' dropdown menus for each mode.
- Set the minutes to send the alert before the PC mode/s activation**: Points to the 'Advance activation alert in: Mins.' dropdown menus.
- Key in your messages for more information**: Points to the 'Alert Message' text boxes.
- Tick to select the smart device**: Points to the 'Select all' button in the Message section.

Setting up PC Status alerts

This feature allows you to send alerts of the unusual activities of the voltage, temperature, and fan settings of your computer to your smart device.

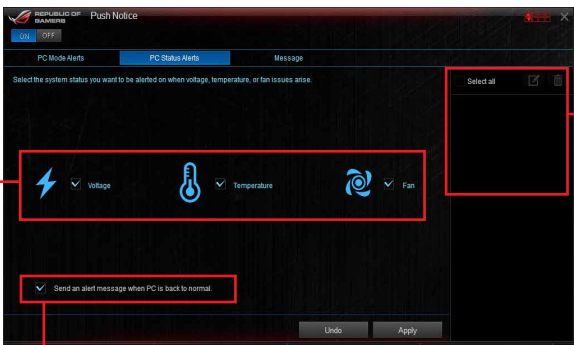



The screenshot shows the 'Push Notice' application interface for configuring 'PC Status Alerts'. The window title is 'Push Notice' and it has a 'Push Notice' logo in the top left. The main title bar says 'PC Status Alerts'. Below the title bar, there are three tabs: 'PC Mode Alerts', 'PC Status Alerts', and 'Message'. The 'PC Status Alerts' tab is active. The interface shows three system status options: Voltage, Temperature, and Fan. Each option has a checkmark and a 'Select' checkbox. Below these options, there is a checkbox for 'Send an alert message when PC is back to normal.'. On the right side, there is a 'Message' section with a 'Select all' button and a trash icon. At the bottom of the window, there are 'Undo' and 'Apply' buttons. Red boxes and arrows point to various elements with the following annotations:

- Tick to select and send alerts to your smart device**: Points to the 'Select' checkboxes for Voltage, Temperature, and Fan.
- Tick to send alert when the selected items are back to its normal status**: Points to the 'Send an alert message when PC is back to normal.' checkbox.
- Tick to select the smart device**: Points to the 'Select all' button in the Message section.

Sending messages to your smart device

This feature allows you to send messages to your smart device.



You can also send messages via the Push Notice messaging shortcut on the lower-right corner of your screen. To do this, click or tap << then click or tap  then select .

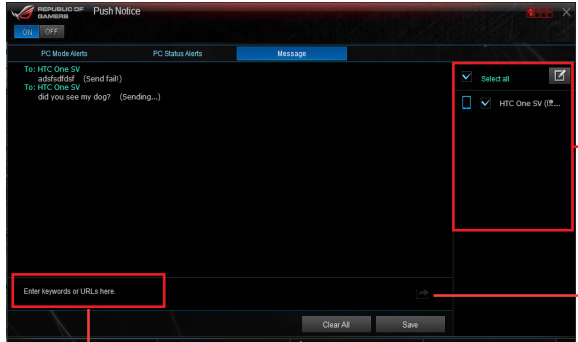

Tick to select the smart device

Click or tap to send your message

Click or tap to key in your message

Viewing your computer status on your smart device

Tap  on your smart device to launch Push Notice.

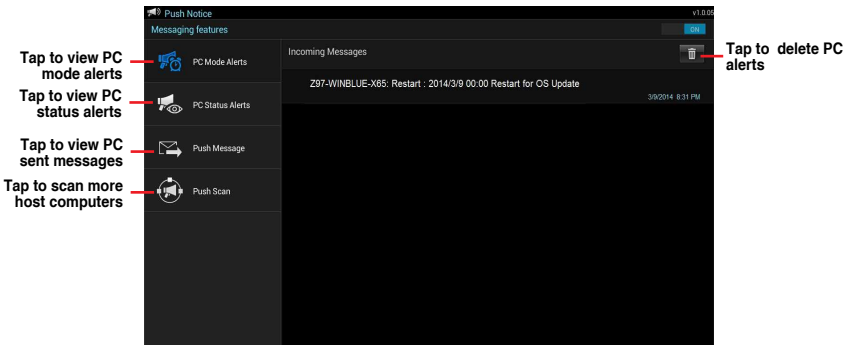

4.6 ROG audio features

Installing the Software

Follow the installation wizard to install the Realtek® Audio Manager driver from the support DVD that is bundled with the motherboard.

If the Realtek® audio software is correctly installed, you will find the Realtek® HD Audio Manager icon on the taskbar. Double-click or tap on the icon to display the Realtek® HD Audio Manager.



Realtek® HD Audio Manager

Sonic Studio

Sonic Studio is an audio suite that offers six audio controls: Reverb, Bass Boost, Equalizer, Voice Clarity, Smart EQ, and Virtual Surround. Virtual Surround is dedicated for 2-channel headset and offers one of the best virtual surround technology for gaming.

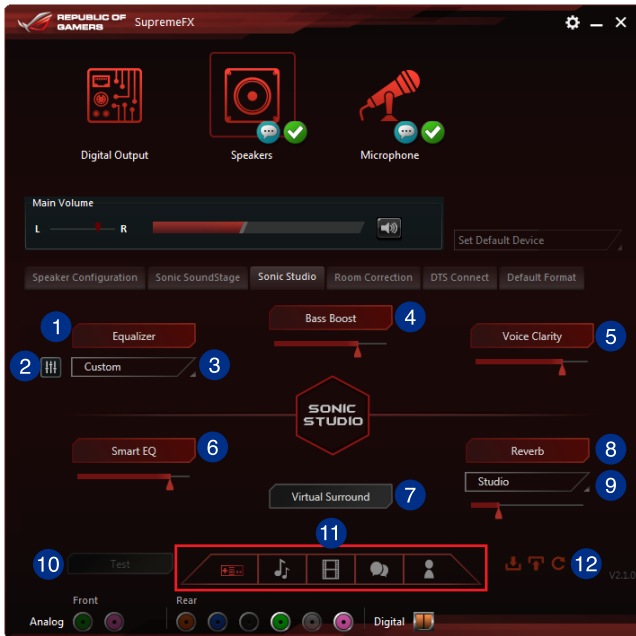

- 1 Equalizer switch**
Click to enable. This item allows you to adjust the parametric EQ settings according to your preference.
- 2 Equalizer advanced settings**
This item available only when the Equalizer switch is enabled. This item allows you to configure the Equalizer settings. You can manually set or customized your setting or choose from any of the preset equalizer settings available.
- 3 Equalizer presets**
Displays the current or selected equalizer preset.
- 4 Bass Boost switch**
Click to boosts the bass effects. Use the slider to adjust the sound of the bass effect.
- 5 Voice Clarity switch**
Click to enable this item. Voice clarity extracts human voice for better dialog/audio communication or to hear vocals more clearly when listening to a music.
- 6 Smart EQ switch**
Dynamically adjust the EQ so you can hear more details.
- 7 Virtual Surround switch**
This item lets you experience 7.1 CH virtual surround from your headset when enabled.
- 8 Reverb switch**
The Reverb effect is part of the Virtual Sound Stage effects that lets you choose other reverb presets.
- 9 Reverb presets**
Click to choice and select a reverb effect from the different environmental spaces for reverb effects.

This item is only available when the Reverb switch is enabled.
- 10 Test tone**
Click this button to start the test for the selected preset profile.
- 11 Preset profiles**
Click any of the preset profiles. Choose from Gaming, music, movie, or communication.
- 12 Profile import/export**
Allows you to Import, export, or revert to the default setting of a profile.

Sonic SenseAmp

Sonic SenseAmp is an exclusive ROG invention that is a built-in headphone AMP on onboard audio with three AMP levels adjustment. It detects your headphone's impedance and adjusts the built-in AMP accordingly.



Sonic SenseAmp only works on front panel.

When you plug a headphone into the front headphone jack, Sonic SenseAmp displays a pop-up window that displays "Detecting headphone impedance".

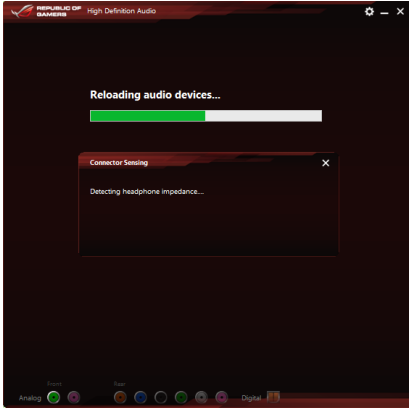

After detecting the headphone's impedance, Sonic SenseAmp displays another pop-up window similar to the one shown below.

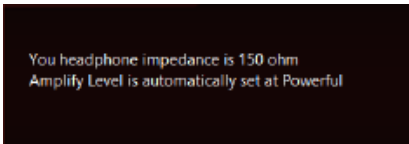

Refer to the table below on the behavior of Sonic SenseAmp when adjusting the impedance of the detected headphone:

32 ohm	Amplify Level is automatically set at Performance
150 ohms	Amplify Level is automatically set at Powerful
> 150 ohms	Amplify Level is automatically set at Extreme
Other device	The device plugged in detected as other device

After you close the pop-window, Sonic SenseAmp enters speaker configuration and displays the adjusted headphone impedance.

Click to manually adjust the amplify level
Displays the impedance of your headphone

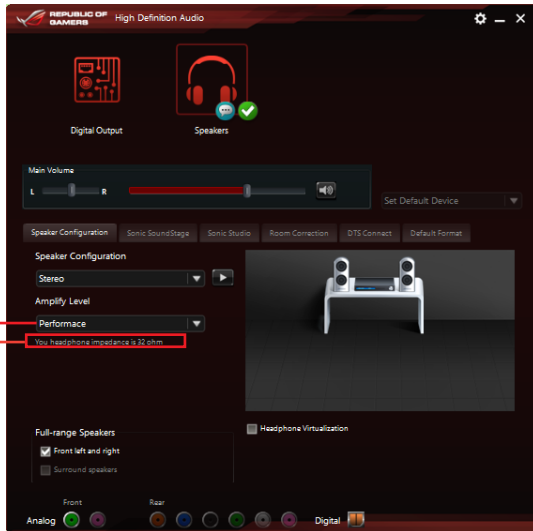

Sonic SoundStage

Sonic SoundStage is a hardware based sound solution for virtual Sound Stage that offers four preset gaming profiles: FPS, Racing, Combat and Sport.



- This feature is only available for front panel Headphone output.
- You can enable this feature by enabling the dedicated SoundStage button on your motherboard. Refer to the section of your motherboard's user guide for the location of the SoundStage button.

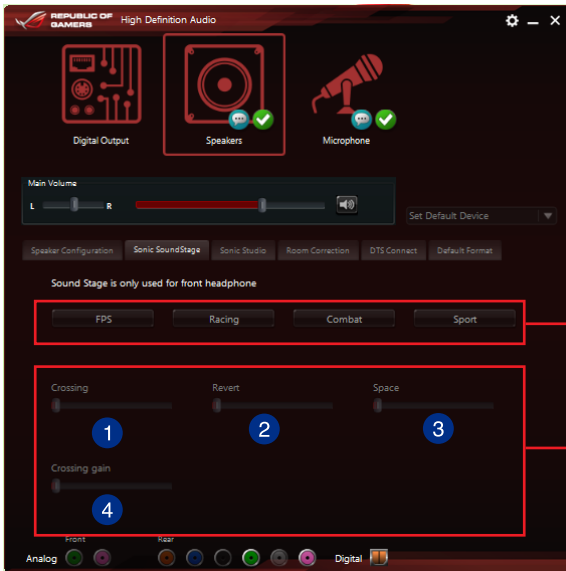

Click any of the four preset gaming profiles

Use the slider to manually adjust the setting of an item

- 1 Crossing**
Move the slider to adjust the amount of cross channel mixing.
- 2 Revert**
Move the slider to revert the main audio source.
- 3 Space**
Move the slider to adjust and virtualize the space sound.
- 4 Crossing gain**
This item only works when Crossing and Revert is enabled. Move the slider to adjust the hardness of the wall.

DTS Connect

DTS Connect delivers excellent audio entertainment across all formats and works with 4, 5.1 and 7.1 channels of incredible surround sound . It also allows you to connect your PC to a home theatre system.

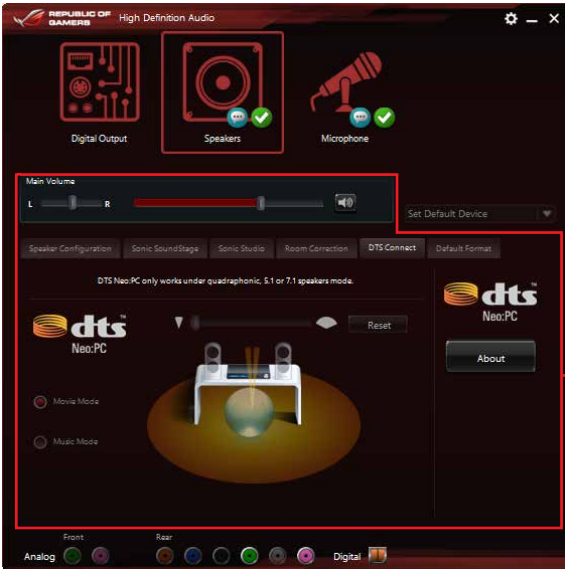

Control settings panel

4.7 Sonic Radar II

Sonic Radar II is designed for First Person Shooting (FPS) games and shows the precise direction and intensity of where a sound is coming from. It features a simple and friendly user-interface and also features sound enhancers to amplify desired sound effects.

Display Menu

Customize the settings for each game including Transparency, Signal, Size, and Remanency.

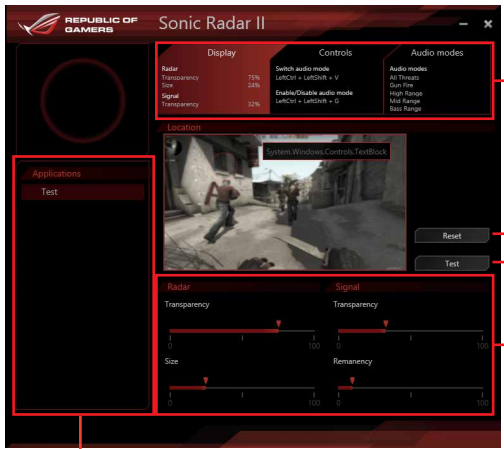

Displays the options available. Click a tab to select an option. Each option has its own settings and menus.

Click to reset to the default settings

Click to start the test tone

Use the sliders to adjust the settings

Displays the list of games

Control Menu

Allows you to configure shortcut keys.



Audio Mode/Radar Selection menu

Allows you to configure the sound enhancers.



Tick to choose the desired sound enhancer



Audio Mode/Radar Selection are enabled with shortcut keys in the game. Refer to the **Controls** tab for more information about the shortcut key settings.

4.8 GameFirst III

GameFirst III is a network management software that features four preset packet prioritized profiles (Optimization, Game, Media Streaming and File Sharing) facilitating different user scenarios. Users can also manually allocate bandwidth and adjust priority settings of each application to run faster and smoother.

To use GameFirst III, double-click  on the desktop.



The screenshot shows the GameFirst III interface with the following callouts:

- Click to open the tabs for different functions:** Points to the top navigation bar with tabs for Application, Network Monitor, Bandwidth Test, and Network Information.
- Click any item for quick view:** Points to the application list table.
- Click to load a preset priority profile and configure its settings:** Points to the 'Select priority profile mode' sidebar with numbered items 1-4.
- Tick to toggle the preset priority profile function on/off:** Points to the 'ON OFF' function switch at the bottom left.
- Use the bar to adjust the bandwidth speed settings or key in the value of the input field:** Points to the bandwidth sliders in the application list.
- Tick to display all the applications:** Points to the 'Show all applications' checkbox at the bottom left.
- Click to reset and load the default settings of the selected profile:** Points to the 'Reset' button at the bottom right.
- Allows you to block traffic of the application or set priority:** Points to the 'priority' column in the application list.

- 1 **Optimization Mode**
Game packets are prioritized and other packets also optimized.
- 2 **Game Mode**
Game packets given top priority.
- 3 **Media Streaming Mode**
Media-streaming packets given top priority.
- 4 **File Sharing Mode**
File-sharing packets given top priority.

Network Monitor

Top 5 application

Displays the top 5 bandwidth consuming applications currently used.

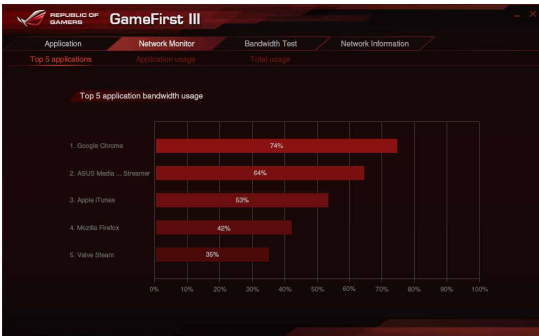

Application usage

Displays the individual downloading and uploading bandwidth of currently used applications.

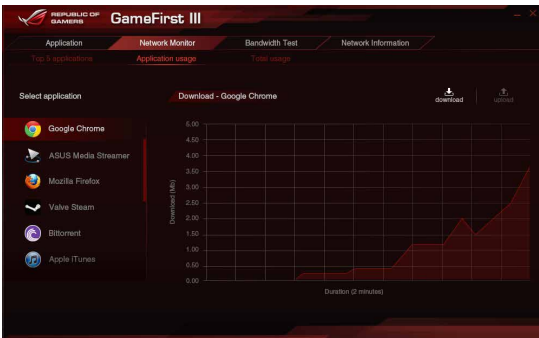

Total usage

Displays the total downloading and uploading bandwidth of the currently used applications.

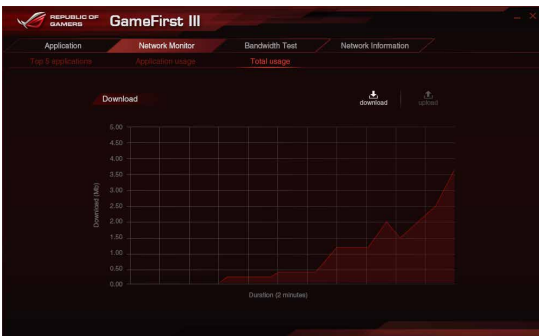

Bandwidth Test

You can use this feature to test the Internet Service Provider (ISP) speed or manually key in the desired uploading/downloading speed and apply the speed if needed.

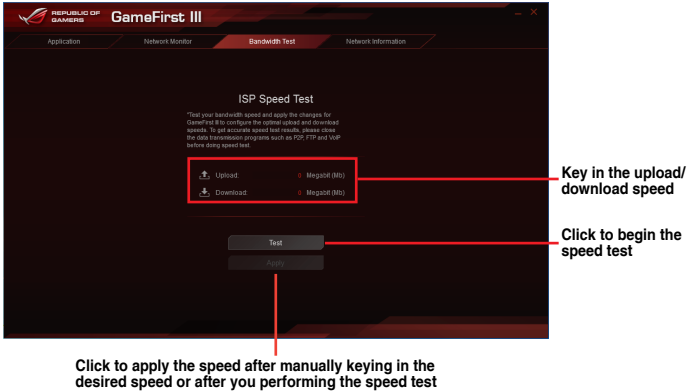

Using the Network Information

Displays information about the physical network card such as speed, physical address, IP address, subnet mask, and default gateway.



4.9 KeyBot

KeyBot is a built-in microprocessor that provides instant upgrade to your keyboard. You can configure and assign macros to specific keys on your keyboard to perform specific or several task at the same time. You can also configure your PC to wake up in CPU Level UP, XMP, or directly to BIOS mode.

To use KeyBot:

1. Press the KeyBot button on the motherboard.



The KeyBot feature is enabled when the KEYBOT_LED light is on.

2. Connect the USB keyboard into the dedicated KeyBot USB port.



Refer to the **Rear I/O connection** or the **USB BIOS Flashback** section for more information about the location of the KeyBot USB port.

3. Double-click  on the desktop to launch the KeyBot application on your PC.

Click to import or export configuration files

Click to configure Macro keys, Smart login, Function keys, and Shortcut settings

Tick to toggle the KeyBot function on/off

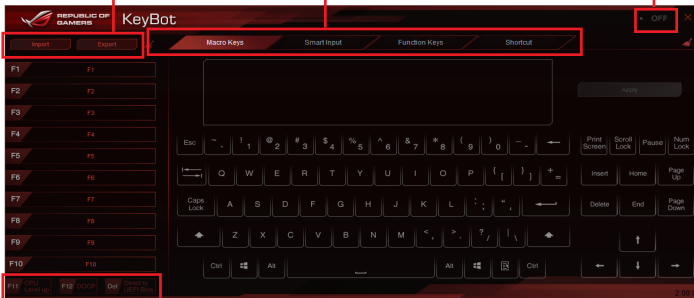

Click any of the items to perform a specific tasks, or click their corresponding keys on the keyboard

Smart Input

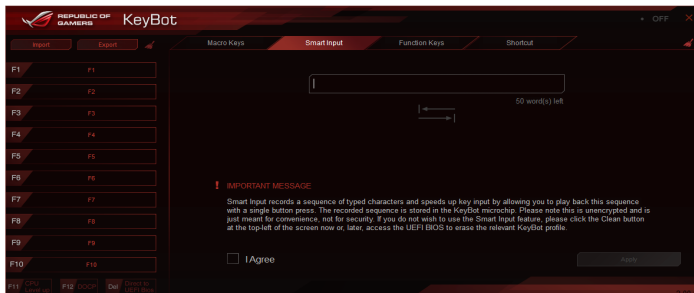

Function Keys

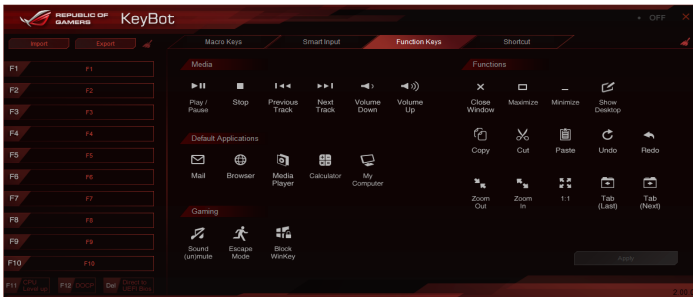

Shortcut

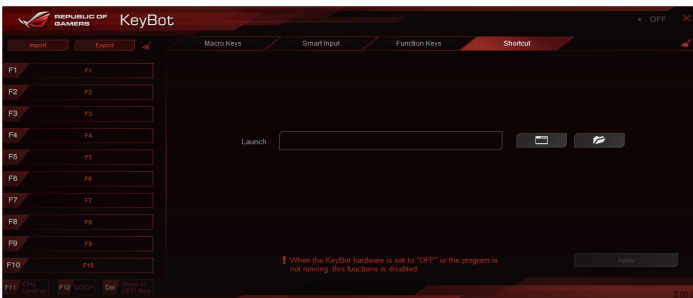

4.10 ASUS Media Streamer

ASUS Media Streamer allows you to enjoy your PC's multimedia content anywhere. You can pipe music from your PC or stream your favorite movie to a smart TV using your PC or smart device.



- Ensure to enable the DLNA setting of your devices first.
- ASUS Media Streamer supports NFC function.



- Ensure to install ASUS HomeCloud on your PC.
- An Internet connection is required to fully utilize this feature.

To use ASUS Media Streamer:

On your computer, click **ASUS HomeCloud** then select **Media Streamer**. On your device, click or tap **Media Streamer**.

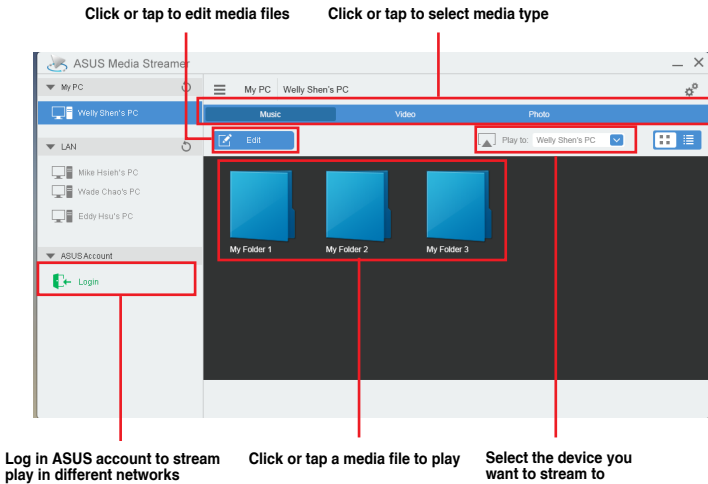

Adding and deleting media files

Drag and drop or tick files to add or delete.

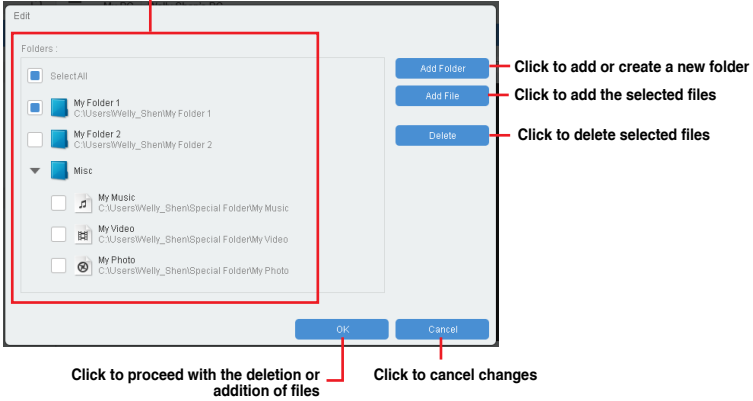

The following media formats are supported: .3gp, .mp4, .m4a, .aac, .ts, .flac, .mp3, .mid, .xmf, .mxmf, .rtttl, .rtx, .ota, .imy, .ogg, .mkv, .wav, .jpg, .gif, .png, .bmp, .webp, .webm

4.11 ASUS Disk Unlocker

This ASUS exclusive utility provides an easy-to-use interface to identify and utilize all drive space in hard disk drives (HDD).



ASUS Disk Unlocker is supported only on Windows® 7 and Windows® 8.



To launch ASUS Disk Unlocker, click  .

Click to open the help file that shows the detailed information on how to use ASUS Disk Unlocker



ASUS Disk Unlocker Help file

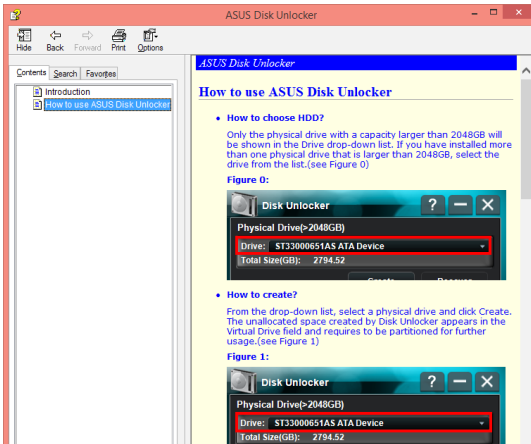

4.12 RAMDisk

RAMDisk is a data-storage software that reserves a part of your system's memory and turns it into a high-speed virtual drive where you can store cache files and game apps for instant access. The Dynamic Memory Allocation function can release the unused memory of RAMDisk back to the system when needed and helps extend the lifespan of your SSD or HDD.



The following folders are not suitable for RAMDisk optimization. Moving them into the RAMDisk might negatively affect the performance of your system.

- **Swap file/Page file:** The swap file is a permanent storage space used as the virtual memory expansion of the system memory. Moving the swap file into the RAM Disk simply defeats the whole purpose of having it and may affect your system's performance.
- **Startup folders:** Since RAMDisk loads during boot up together with the contents of the Junction folders, changing the location of the startup folders may cause system error and disable loading your RAMDisk.



To launch RAMDisk, click

Creating/Deleting a RAMDisk drive

Your RAMDisk drive allows you to place your favorite applications and files into RAM so you can utilize your RAM speed for better read/write performance. The files that are stored inside the RAMDisk are automatically backed up every time your PC is turned off.



The startup time may take a while, depending on the size of your RAMDisk drive.

To create RAMDisk drives:

The screenshot shows the RAMDisk application window. The title bar reads "RAMDisk" and "Junction". The interface includes a "Disk" dropdown menu, a "Size" slider set to 16 MB, a "Dynamic Memory Allocation" checkbox which is checked, and an "Add" button. Below these controls is a table with columns for "Disk", "Size", "Format", and "Delete". The table contains one entry: "F:" with a size of "16MB".

Annotations with red lines pointing to specific UI elements:

- Click to create RAMDisk drives:** Points to the "Disk" dropdown menu.
- Click the drop-down arrow to choose a drive name for your RAMDisk:** Points to the arrow on the "Disk" dropdown.
- Tick to enable Dynamic Memory Allocation function:** Points to the checked checkbox for "Dynamic Memory Allocation".
- Move the slider to the right to set the size allocation:** Points to the "Size" slider.
- Click to finish creating the RAMDisk drive:** Points to the "Add" button.

To delete or format an existing RAMDisk drive:

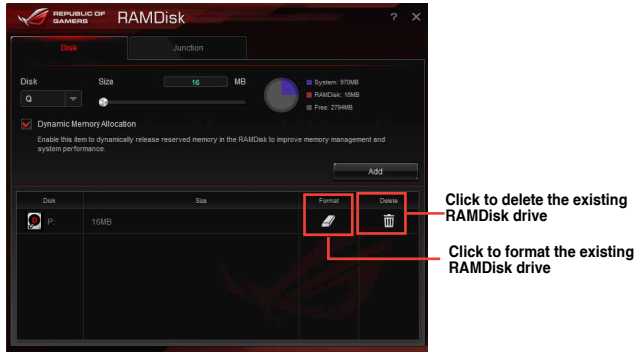

The format function is available only if you enable the Dynamic Memory Allocation function on your disk.

Creating/Deleting a Junction Point

A junction point creates a link that remaps the original contents into the RAMDisk, enabling access to the desired application or data to be done purely within the original file location.

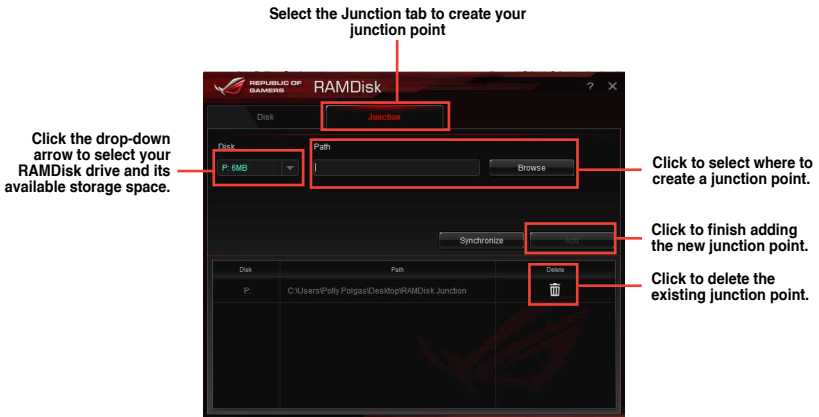

Synchronizing backup files

After creating a junction point, RAMDisk automatically creates a backup folder in the file's original location. Use RAMDisk to manually synchronize updates with these backup files.

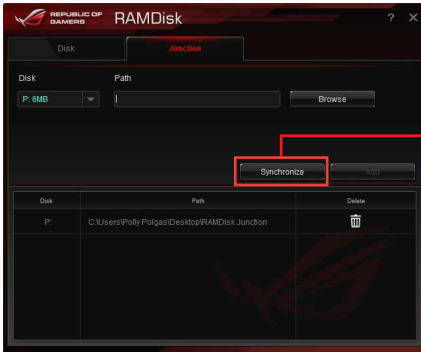

Click Synchronize to update your files

4.13 MemTweakt

MemTweakt is a software that you can use to view all levels of memory timings. You can validate your MemTweakt settings to generate a memory efficiency score that you can share and compare with other users on the ROG website.



MemTweakt functions depends on the chipset on the motherboard. Each chipset has different options.

To use MemTweakt, double-click  on the desktop.

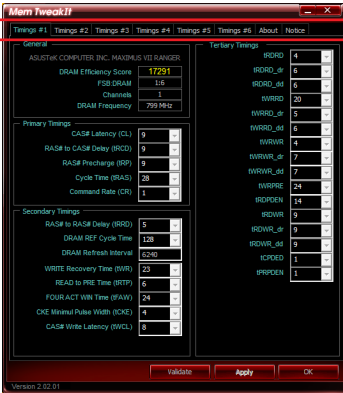

Click a tab to configure the memory timing



Click About tab then click REPUBLIC OF GAMERS to access the official ROG website

Click to exit MemTweakt
Click to apply your settings
Click to validate your settings.

Validating and saving your MemTweakIt settings

To validate and save your configuration online:

1. Launch MemTweakIt and click **Validate**.
2. In **Online Mode**, key in your ASUS account ID and password, and click **Submit**.



Your configuration will be displayed in MemTweakIt webpage.

To validate and save your configuration manually:

1. Launch MemTweakIt and click **Validate**.
2. In **Manual Mode**, click **Save Validation File**.
3. Key in a file name for your configuration file and click **Submit**.
4. Click **validation webpage**.

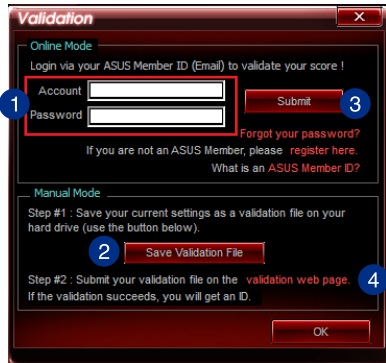

5. In **MemTweakIt - Validation File Upload** window, key in your ASUS account ID and password.
6. Click **Browse**, locate the saved .cvf file, and click **Open**.
7. Click **Submit**.

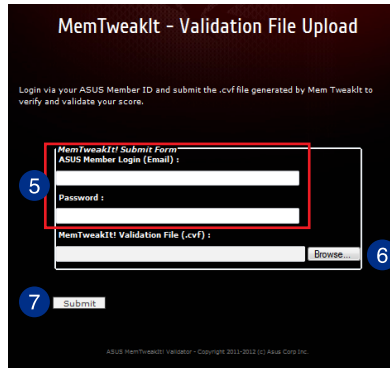

Your configuration will be displayed in MemTweakIt webpage.

4.14 ROG CPU-Z

This utility gathers information about the main devices installed in your system and displays it in an ROG custom layout. ROG CPU-Z provides you information and status of your CPU, motherboard, memory, graphics card, and other components installed in your system. You can generate a report about your system info and send or post it on the CPU-Z website.

To use ROG CPU-Z, double-click  on the desktop.

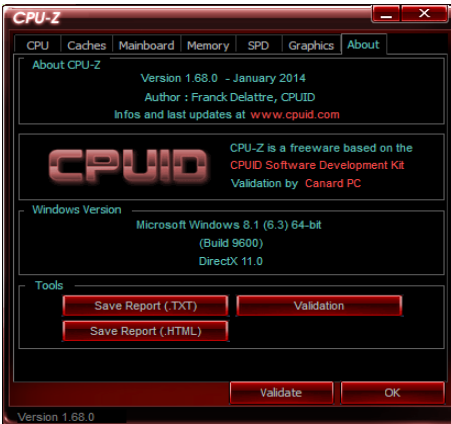
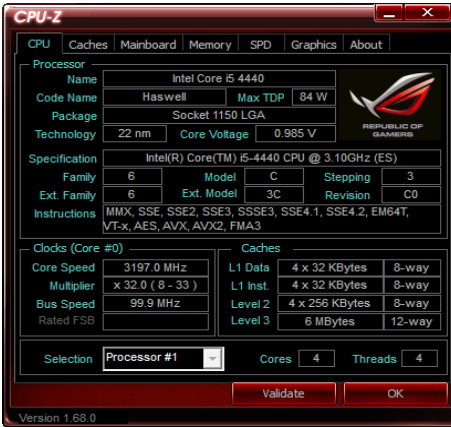

RAID support

5

5.1 RAID configurations

The motherboard comes with the Intel® Rapid Storage Technology that supports RAID 0, RAID 1, RAID 10 and RAID 5 configuration.



If you want to install a Windows® operating system to a hard disk drive included in a RAID set, you have to create a RAID driver disk and load the RAID driver during OS installation.

5.1.1 RAID definitions

RAID 0 (Data striping) optimizes two identical hard disk drives to read and write data in parallel, interleaved stacks. Two hard disks perform the same work as a single drive but at a sustained data transfer rate, double that of a single disk alone, thus improving data access and storage. Use of two new identical hard disk drives is required for this setup.

RAID 1 (Data mirroring) copies and maintains an identical image of data from one drive to a second drive. If one drive fails, the disk array management software directs all applications to the surviving drive as it contains a complete copy of the data in the other drive. This RAID configuration provides data protection and increases fault tolerance to the entire system. Use two new drives or use an existing drive and a new drive for this setup. The new drive must be of the same size or larger than the existing drive.

RAID 5 stripes both data and parity information across three or more hard disk drives. Among the advantages of RAID 5 configuration include better HDD performance, fault tolerance, and higher storage capacity. The RAID 5 configuration is best suited for transaction processing, relational database applications, enterprise resource planning, and other business systems. Use a minimum of three identical hard disk drives for this setup.

RAID 10 is data striping and data mirroring combined without parity (redundancy data) having to be calculated and written. With the RAID 10 configuration you get all the benefits of both RAID 0 and RAID 1 configurations. Use four new hard disk drives or use an existing drive and three new drives for this setup.

5.1.2 Installing Serial ATA hard disks

The motherboard supports Serial ATA hard disk drives. For optimal performance, install identical drives of the same model and capacity when creating a disk array.

To install the SATA hard disks for a RAID configuration:

1. Install the SATA hard disks into the drive bays.
2. Connect the SATA signal cables.
3. Connect a SATA power cable to the power connector on each drive.

5.1.3 Setting the RAID item in BIOS

You must enable the RAID function in the BIOS Setup before creating RAID sets using SATA HDDs. To do this:

1. Enter the BIOS Setup during POST.
2. Go to the **Advanced** menu > **SATA Configuration**, and then press <Enter>.
3. Set the OnChip SATA Type item to [RAID].
4. Save your changes, and then exit the BIOS Setup.



Refer to Chapter 3 for details on entering and navigating through the BIOS Setup

5.1.3 AMD® Option ROM Utility

To enter the AMD® Option ROM utility:

1. Boot up your computer.
2. During POST, press <Ctrl> + <F> to display the utility main menu.

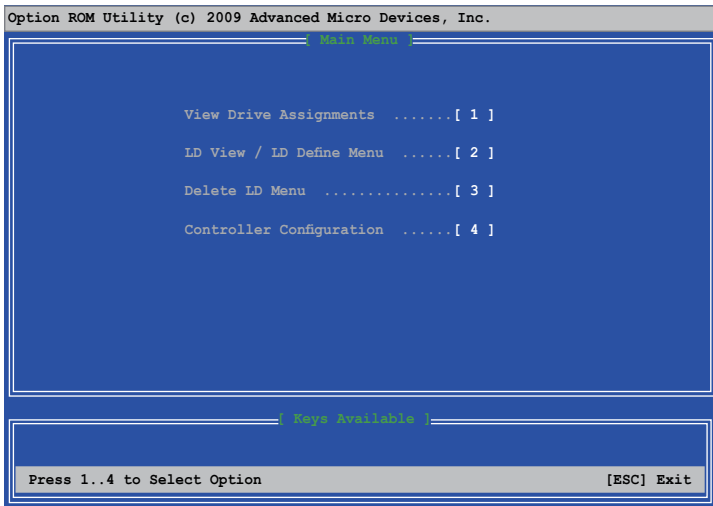

The Main Menu allows you to select an operation to perform. The Main Menu options include:

- **View Drive Assignments:** shows the status of the hard disk drives.
- **LD View / LD Define Menu:** displays the existing RAID set information / creates a RAID 0, RAID 1, or RAID 10 configuration.
- **Delete LD Menu:** deletes a selected RAID set and partition.
- **Controller Configuration:** shows the system resources configuration.

Press <1>, <2>, <3>, or <4> to enter the option you need; press <ESC> to exit the utility.



The RAID BIOS setup screens shown in this section are for reference only, and may not exactly match the items on your screen.



To create a RAID volume using more than four hard disk drives, ensure that the SATA connectors 5/6 are set to [RAID] mode.

Creating a RAID volume

To create a RAID volume:

1. In the Main Menu, press <2> to enter the **LD View / LD Define Menu** function.
2. Press <Ctrl> + <C>, and the following screen appears.

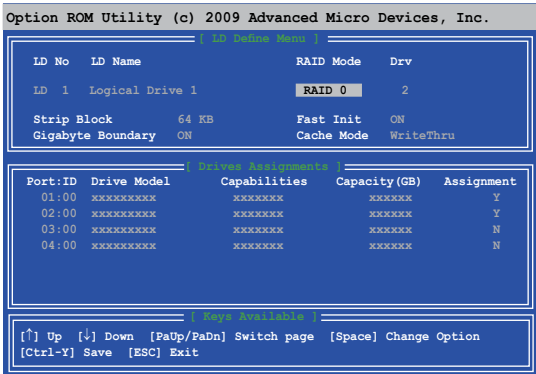

3. Move to the **RAID Mode** item and press <Space> to select a RAID mode to create.
4. Move to the **Assignment** item by using the down arrow key and set **Y** to select the hard disk drives you want to include in the RAID set.
5. Press <Ctrl> + <Y> to save the setting.
6. The utility prompts the following message. Press <Ctrl> + <Y> to input the LD name.

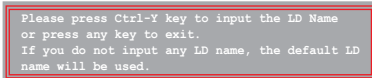

7. Enter an LD name, and then press any key to continue.



8. Press <Ctrl> + <Y> to erase the MBR, or you may press any key to abort the settings.

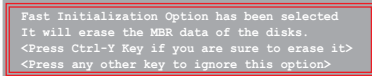

9. Press <Ctrl> + <Y> to enter the screen to modify the array capacity, or press any key to use the maximum capacity.

5.2 Install the RAID driver during Windows® OS installation

To install the RAID driver in Windows® XP:

1. During the OS installation, the system prompts you to press the F6 key to install third-party SCSI or RAID driver.
2. Press <F6>, and then insert the floppy disk with RAID driver into the USB floppy disk drive.
3. When prompted to select the SCSI adapter to install, select the RAID driver for the corresponding OS version.
4. Follow the succeeding screen instructions to complete the installation.

To install the RAID driver for Windows® Vista or later OS:

1. During the OS installation, click **Load Driver** to allow you to select the installation media containing the RAID driver.
2. Insert the USB flash drive with RAID driver into the USB port or the support DVD into the optical drive, and then click **Browse**.
3. Click the name of the device you've inserted, go to **Drivers > RAID**, and then select the RAID driver for the corresponding OS version. Click **OK**.
4. Follow the succeeding screen instructions to complete the installation.



Before loading the RAID driver from a USB flash drive, you have to use another computer to copy the RAID driver from the support DVD to the USB flash drive.

Appendices

Notices

Federal Communications Commission Statement

This device complies with Part 15 of the FCC Rules. Operation is subject to the following two conditions:

- This device may not cause harmful interference.
- This device must accept any interference received including interference that may cause undesired operation.

This equipment has been tested and found to comply with the limits for a Class B digital device, pursuant to Part 15 of the FCC Rules. These limits are designed to provide reasonable protection against harmful interference in a residential installation. This equipment generates, uses and can radiate radio frequency energy and, if not installed and used in accordance with manufacturer's instructions, may cause harmful interference to radio communications. However, there is no guarantee that interference will not occur in a particular installation. If this equipment does cause harmful interference to radio or television reception, which can be determined by turning the equipment off and on, the user is encouraged to try to correct the interference by one or more of the following measures:

- Reorient or relocate the receiving antenna.
- Increase the separation between the equipment and receiver.
- Connect the equipment to an outlet on a circuit different from that to which the receiver is connected.
- Consult the dealer or an experienced radio/TV technician for help.



The use of shielded cables for connection of the monitor to the graphics card is required to assure compliance with FCC regulations. Changes or modifications to this unit not expressly approved by the party responsible for compliance could void the user's authority to operate this equipment.

IC: Canadian Compliance Statement

Complies with the Canadian ICES-003 Class B specifications. This device complies with RSS 210 of Industry Canada. This Class B device meets all the requirements of the Canadian interference-causing equipment regulations.

This device complies with Industry Canada license exempt RSS standard(s). Operation is subject to the following two conditions: (1) this device may not cause interference, and (2) this device must accept any interference, including interference that may cause undesired operation of the device.

Cet appareil numérique de la Classe B est conforme à la norme NMB-003 du Canada. Cet appareil numérique de la Classe B respecte toutes les exigences du Règlement sur le matériel brouilleur du Canada.

Cet appareil est conforme aux normes CNR exemptes de licence d'Industrie Canada. Le fonctionnement est soumis aux deux conditions suivantes :

- (1) cet appareil ne doit pas provoquer d'interférences et
- (2) cet appareil doit accepter toute interférence, y compris celles susceptibles de provoquer un fonctionnement non souhaité de l'appareil.

Canadian Department of Communications Statement

This digital apparatus does not exceed the Class B limits for radio noise emissions from digital apparatus set out in the Radio Interference Regulations of the Canadian Department of Communications.

This class B digital apparatus complies with Canadian ICES-003.

VCCI: Japan Compliance Statement

VCCI Class B Statement

この装置は、クラスB情報技術装置です。この装置は、家庭環境で使用することを目的としていますが、この装置がラジオやテレビジョン受信機に近接して使用されると、受信障害を引き起こすことがあります。

取扱説明書に従って正しい取り扱いをして下さい。

VCCI-B

This is a Class B product based on the standard of the VCCI Council. If this is used near a radio or television receiver in a domestic environment, it may cause radio interference. Install and use the equipment according to the instruction manual.

KC: Korea Warning Statement

B급 기기 (가정용 방송통신기자재)

이 기기는 가정용(B급) 전자파적합기기로서 주로 가정에서 사용하는 것을 목적으로 하며, 모든 지역에서 사용할 수 있습니다.

*당해 무선설비는 전파혼신 가능성이 있으므로 인명안전과 관련된 서비스는 할 수 없습니다.

REACH

Complying with the REACH (Registration, Evaluation, Authorisation, and Restriction of Chemicals) regulatory framework, we published the chemical substances in our products at ASUS REACH website at <http://csr.asus.com/english/REACH.htm>.



DO NOT throw the motherboard in municipal waste. This product has been designed to enable proper reuse of parts and recycling. This symbol of the crossed out wheeled bin indicates that the product (electrical and electronic equipment) should not be placed in municipal waste. Check local regulations for disposal of electronic products.



DO NOT throw the mercury-containing button cell battery in municipal waste. This symbol of the crossed out wheeled bin indicates that the battery should not be placed in municipal waste.

ASUS Recycling/Takeback Services

ASUS recycling and takeback programs come from our commitment to the highest standards for protecting our environment. We believe in providing solutions for you to be able to responsibly recycle our products, batteries, other components as well as the packaging materials. Please go to <http://csr.asus.com/english/Takeback.htm> for detailed recycling information in different regions.

Google™ License Terms

Copyright© 2014 Google Inc. All Rights Reserved.

Licensed under the Apache License, Version 2.0 (the “License”); you may not use this file except in compliance with the License. You may obtain a copy of the License at:

<http://www.apache.org/licenses/LICENSE-2.0>

Unless required by applicable law or agreed to in writing, software distributed under the License is distributed on an “AS IS” BASIS, WITHOUT WARRANTIES OR CONDITIONS OF ANY KIND, either express or implied.

See the License for the specific language governing permissions and limitations under the License.

ASUS contact information

ASUSTeK COMPUTER INC.

Address 15 Li-Te Road, Peitou, Taipei, Taiwan 11259
Telephone +886-2-2894-3447
Fax +886-2-2890-7798
E-mail info@asus.com.tw
Web site www.asus.com.com/

Technical Support

Telephone +86-21-38429911
Fax +86-21-5866-8722, ext. 9101#
Online support <http://www.asus.com/tw/support/>

ASUS COMPUTER INTERNATIONAL (America)

Address 800 Corporate Way, Fremont, CA 94539, USA
Telephone +1-510-739-3777
Fax +1-510-608-4555
Web site <http://www.asus.com/us/>

Technical Support

Support fax +1-812-284-0883
Telephone +1-812-282-2787
Online support <http://www.service.asus.com/>

ASUS COMPUTER GmbH (Germany and Austria)

Address Harkort Str. 21-23, D-40880 Ratingen, Germany
Fax +49-2102-959911
Web site <http://www.asus.com/de>
Online contact <http://eu-rma.asus.com/sales>

Technical Support

Telephone +49-1805-010923*
Support Fax +49-2102-9599-11
Online support <http://www.asus.com/de/support/>

