

970 PRO GAMING/AURA



Motherboard

Copyright © 2015 ASUSTeK COMPUTER INC. All Rights Reserved.

No part of this manual, including the products and software described in it, may be reproduced, transmitted, transcribed, stored in a retrieval system, or translated into any language in any form or by any means, except documentation kept by the purchaser for backup purposes, without the express written permission of ASUSTeK COMPUTER INC. ("ASUS").

Product warranty or service will not be extended if: (1) the product is repaired, modified or altered, unless such repair, modification or alteration is authorized in writing by ASUS; or (2) the serial number of the product is defaced or missing.

ASUS PROVIDES THIS MANUAL "AS IS" WITHOUT WARRANTY OF ANY KIND, EITHER EXPRESS OR IMPLIED, INCLUDING BUT NOT LIMITED TO THE IMPLIED WARRANTIES OR CONDITIONS OF MERCHANTABILITY OR FITNESS FOR A PARTICULAR PURPOSE. IN NO EVENT SHALL ASUS, ITS DIRECTORS, OFFICERS, EMPLOYEES OR AGENTS BE LIABLE FOR ANY INDIRECT, SPECIAL, INCIDENTAL, OR CONSEQUENTIAL DAMAGES (INCLUDING DAMAGES FOR LOSS OF PROFITS, LOSS OF BUSINESS, LOSS OF USE OR DATA, INTERRUPTION OF BUSINESS AND THE LIKE), EVEN IF ASUS HAS BEEN ADVISED OF THE POSSIBILITY OF SUCH DAMAGES ARISING FROM ANY DEFECT OR ERROR IN THIS MANUAL OR PRODUCT.

SPECIFICATIONS AND INFORMATION CONTAINED IN THIS MANUAL ARE FURNISHED FOR INFORMATIONAL USE ONLY, AND ARE SUBJECT TO CHANGE AT ANY TIME WITHOUT NOTICE, AND SHOULD NOT BE CONSTRUED AS A COMMITMENT BY ASUS. ASUS ASSUMES NO RESPONSIBILITY OR LIABILITY FOR ANY ERRORS OR INACCURACIES THAT MAY APPEAR IN THIS MANUAL, INCLUDING THE PRODUCTS AND SOFTWARE DESCRIBED IN IT.

Products and corporate names appearing in this manual may or may not be registered trademarks or copyrights of their respective companies, and are used only for identification or explanation and to the owners' benefit, without intent to infringe.

Offer to Provide Source Code of Certain Software

This product contains copyrighted software that is licensed under the General Public License ("GPL"), under the Lesser General Public License Version ("LGPL") and/or other Free Open Source Software Licenses. Such software in this product is distributed without any warranty to the extent permitted by the applicable law. Copies of these licenses are included in this product.

Where the applicable license entitles you to the source code of such software and/or other additional data, you may obtain it for a period of three years after our last shipment of the product, either

(1) for free by downloading it from <http://www.asus.com/support/download>

or

(2) for the cost of reproduction and shipment, which is dependent on the preferred carrier and the location where you want to have it shipped to, by sending a request to:

ASUSTeK Computer Inc.
Legal Compliance Dept.
15 Li Te Rd.,
Beitou, Taipei 112
Taiwan

In your request please provide the name, model number and version, as stated in the About Box of the product for which you wish to obtain the corresponding source code and your contact details so that we can coordinate the terms and cost of shipment with you.

The source code will be distributed WITHOUT ANY WARRANTY and licensed under the same license as the corresponding binary/object code.

This offer is valid to anyone in receipt of this information.

ASUSTeK is eager to duly provide complete source code as required under various Free Open Source Software licenses. If however you encounter any problems in obtaining the full corresponding source code we would be much obliged if you give us a notification to the email address gpl@asus.com, stating the product and describing the problem (please DO NOT send large attachments such as source code archives, etc. to this email address).

Contents

Safety information.....	iv
About this guide.....	iv
Package contents.....	vi
970 PRO GAMING/AURA specifications summary	vi

Chapter 1: Product Introduction

1.1 Before you proceed	1-1
1.2 Motherboard overview.....	1-1
1.3 Central Processing Unit (CPU)	1-5
1.4 System memory	1-9
1.5 Expansion slots.....	1-12
1.6 Jumpers	1-15
1.7 Connectors	1-17
1.8 Onboard LEDs.....	1-26

Chapter 2: BIOS Information

2.1 Managing and updating your BIOS	2-1
2.2 BIOS setup program	2-6
2.3 My Favorites	2-10
2.4 Main menu	2-11
2.5 Ai Tweaker menu.....	2-13
2.6 Advanced menu	2-18
2.7 Monitor menu	2-24
2.8 Boot menu	2-28
2.9 Tool menu.....	2-33
2.10 Exit menu	2-34

Appendices

Notices	A-1
ASUS contact information.....	A-5

Safety information

Electrical safety

- To prevent electrical shock hazard, disconnect the power cable from the electrical outlet before relocating the system.
- When adding or removing devices to or from the system, ensure that the power cables for the devices are unplugged before the signal cables are connected. If possible, disconnect all power cables from the existing system before you add a device.
- Before connecting or removing signal cables from the motherboard, ensure that all power cables are unplugged.
- Seek professional assistance before using an adapter or extension cord. These devices could interrupt the grounding circuit.
- Ensure that your power supply is set to the correct voltage in your area. If you are not sure about the voltage of the electrical outlet you are using, contact your local power company.
- If the power supply is broken, do not try to fix it by yourself. Contact a qualified service technician or your retailer.

Operation safety

- Before installing the motherboard and adding devices on it, carefully read all the manuals that came with the package.
- Before using the product, ensure all cables are correctly connected and the power cables are not damaged. If you detect any damage, contact your dealer immediately.
- To avoid short circuits, keep paper clips, screws, and staples away from connectors, slots, sockets and circuitry.
- Avoid dust, humidity, and temperature extremes. Do not place the product in any area where it may become wet.
- Place the product on a stable surface.
- If you encounter technical problems with the product, contact a qualified service technician or your retailer.

About this guide

This user guide contains the information you need when installing and configuring the motherboard.

How this guide is organized

This guide contains the following parts:

- **Chapter 1: Product Introduction**
This chapter describes the features of the motherboard and the new technology it supports.
- **Chapter 2: BIOS Information**
This chapter tells how to change system settings through the BIOS Setup menus. Detailed descriptions of the BIOS parameters are also provided.

- **Chapter 3: Software Support**

This chapter describes the contents of the support DVD that comes with the motherboard package and the software.

Where to find more information

Refer to the following sources for additional information and for product and software updates.

1. **ASUS websites**

The ASUS website provides updated information on ASUS hardware and software products. Refer to the ASUS contact information.

2. **Optional documentation**

Your product package may include optional documentation, such as warranty flyers, that may have been added by your dealer. These documents are not part of the standard package.

Conventions used in this guide

To ensure that you perform certain tasks properly, take note of the following symbols used throughout this manual.



DANGER/WARNING: Information to prevent injury to yourself when trying to complete a task.



CAUTION: Information to prevent damage to the components when trying to complete a task.



IMPORTANT: Instructions that you **MUST** follow to complete a task.



NOTE: Tips and additional information to help you complete a task.

Typography

Bold text

Indicates a menu or an item to select.

Italics

Used to emphasize a word or a phrase.

<Key>

Keys enclosed in the less-than and greater-than sign means that you must press the enclosed key.

Example: <Enter> means that you must press the Enter or Return key.

<Key1> + <Key2> + <Key3>

If you must press two or more keys simultaneously, the key names are linked with a plus sign (+).

Package contents

Check your motherboard package for the following items.

Motherboard	ASUS Gaming Motherboard - 970 PRO GAMING/AURA
Cables	2 x Serial ATA 6.0 Gb/s cables 1 x SLI™ bridge
Accessories	1 x I/O Shield 1 x cable label 1 x pack of cable tie 1 x M.2 Screw package
Application DVD	Support DVD
Documentation	User manual



If any of the above items is damaged or missing, contact your retailer.

970 PRO GAMING/AURA specifications summary

CPU	AMD AM3+ FX™/Phenom™ II/Athlon™ II/Sempron™ 100 Series Processors Supports AM3+ 32 nm CPU Supports CPU up to 125 W AMD Cool 'n' Quiet™ Technology * Refer to www.asus.com for CPU support list.
Chipset	AMD® 970+SB950 Chipset
Memory	4 x DIMM, max. 32GB DDR3 2133(OC)*/1866/1600/1333/1066 MHz, non-ECC, un-buffered memory Dual-channel memory architecture * Refer to www.asus.com for the Memory QVL (Qualified Vendors Lists). * Due to OS limitation, when installing total memory of 4GB capacity or more, Windows® 32-bit operation system may only recognize less than 3GB. Install a 64-bit Windows® OS when you want to install 4GB or more memory on the motherboard. * Due to CPU spec., AMD 100 series CPUs support up to DDR3 1066MHz. With ASUS design, this motherboard can support up to DDR3 1333MHz.
System Bus	Up to 4.8 GT/s HyperTransport™ 3
Multi-GPU support	Supports NVIDIA® Quad-GPU SLI™ Technology Supports AMD® Quad-GPU CrossFireX™ Technology
Expansion slots	2 x PCI Express 2.0 x16 slots (supports x16, x8/x8) 2 x PCI Express 2.0 x1 slot 2 x PCI slots

(continued on the next page)

970 PRO GAMING/AURA specifications summary

Storage	<p>AMD SB950 controller:</p> <ul style="list-style-type: none"> - 6 x SATA 6Gb/s port(s) (black) with Raid 0, 1, 5, 10 support - 1 x M.2 Socket 3 with M Key, type 2242/2260/2280 storage devices support (PCIe 2.0 x4)
LAN	<p>Intel I211 Gb LAN Anti-surge LANGuard GameFirst technology</p>
Audio	<p>SupremeFX 8-Channel High Definition Audio CODEC</p> <ul style="list-style-type: none"> - Supports: Jack-detection, Multi-streaming, Front Panel MIC Jack-retasking - High quality 115dB SNR stereo playback output <p>Audio Features :</p> <ul style="list-style-type: none"> - SupremeFX Shielding™ Technology - Headphone AMP - Optical S/PDIF out port at back panel - Sonic Radar II
USB	<p>ASMedia® USB 3.1 controller:</p> <ul style="list-style-type: none"> - 2 x USB 3.1 ports (2 x Type-A at back panel) <p>ASMedia® USB 3.0 controller:</p> <ul style="list-style-type: none"> - 2 x USB 3.0 port(s) (2 at mid-board) <p>AMD SB950 controller:</p> <ul style="list-style-type: none"> - 14 x USB 2.0 port(s) (8 at back panel, black, 6 at mid-board)
Internal I/O connectors	<p>1 x 19-pin USB 3.0/2.0 connector supports additional 2 USB 3.0/2.0 port 3 x USB 2.0/1.1 connectors support additional 6 USB 2.0/1.1 ports 1 x System panel header 1 x Front panel audio connector (AAFP) 6 x SATA 6.0 Gb/s connectors (Black) 1 x M.2 Socket 3 for M Key, type 2242/2260/2280 devices 1 x Water pump connector (4-pin) 1 x CPU fan connector (4-pin) 1 x CPU OPT fan connector (4-pin) 3 x Chassis Fan connectors (4-pin) 1 x COM connector 1 x TPM header 1 x 24-pin EATX Power connector 1 x 8-pin EATX 12V Power connector 1 x Slow Mode header 1 x Safe Boot header 1 x ReTry header 1 x Clear CMOS jumper</p>

(continued on the next page)

970 PRO GAMING/AURA specifications summary

ASUS Gaming Features	<p>Gamer's Guardian</p> <ul style="list-style-type: none"> - DIGI+ VRM - DRAM Overcurrent Protection - ESD Guards on LAN, Audio, KBMS and USB3.1/3.0/2.0 ports - Stainless Steel Back I/O - Q-Design (Q-Shield, Q-DIMM, Q-LED, Q-Slot) <p>Performance Level Up</p> <ul style="list-style-type: none"> - DIGI+ VRM - AI Suite 3 - Fan Xpert 2 - UEFI BIOS EZ Mode (O.C. Tuner, CrashFree BIOS 3, EZ Flash 2) - RAMCache - Speed your game loads - USB 3.1 Boost featuring speedy USB 3.1 transmission <p>ASUS Exclusive Features</p> <ul style="list-style-type: none"> - Disk Unlocker - Push Notice - AI Charger+ - ASUS CPU-Z - Aura: RGB Lighting control
Back panel I/O ports	<p>1 x PS/2 keyboard/mouse combo port 1 x optical SPDIF out 1 x LAN (RJ45) port 2 x USB 3.1 ports (2 x Type-A, Red) 8 x USB 2.0 ports 8-channel audio I/O ports</p>
BIOS features	<p>64 Mb Flash ROM, UEFI BIOS, PnP, DMI2.0, WfM2.0, SM BIOS 2.7, ACPI 2.0a, Multi-language BIOS, ASUS EZ Flash 2, F12 PrintScreen, F3 Shortcut Function and ASUS DRAM SPD (Serial Presence Detect) memory information</p>
Manageability	<p>WfM 2.0, DMI 2.0, WOL by PME, WOR by PME, PXE</p>
Support DVD	<p>Drivers ASUS utilities EZ Update Anti-virus software (OEM version)</p>
Operating system support	<p>Windows® 10 (64-bit) Windows® 8.1 (64-bit) Windows® 7 (64-bit/32-bit)</p>
Form factor	<p>ATX Form Factor, 12" x 9.6" (30.5cm x 24.4cm)</p>



Specifications are subject to change without notice.

Product Introduction

1

1.1 Before you proceed

Take note of the following precautions before you install motherboard components or change any motherboard settings.



-
- Unplug the power cord from the wall socket before touching any component.
 - Before handling components, use a grounded wrist strap or touch a safely grounded object or a metal object, such as the power supply case, to avoid damaging them due to static electricity.
 - Hold components by the edges to avoid touching the ICs on them.
 - Whenever you uninstall any component, place it on a grounded antistatic pad or in the bag that came with the component.
 - Before you install or remove any component, ensure that the ATX power supply is switched off or the power cord is detached from the power supply. Failure to do so may cause severe damage to the motherboard, peripherals, or components.
-

1.2 Motherboard overview

Before you install the motherboard, study the configuration of your chassis to ensure that the motherboard fits into it.



Ensure that you unplug the power cord before installing or removing the motherboard. Failure to do so can cause you physical injury and damage motherboard components.

1.2.1 Placement direction

When installing the motherboard, ensure that you place it into the chassis in the correct orientation. The edge with external ports goes to the rear part of the chassis as indicated in the image below.

1.2.2 Screw holes

Place nine (9) screws into the holes indicated by circles to secure the motherboard to the chassis.



Do not overtighten the screws! Doing so can damage the motherboard.

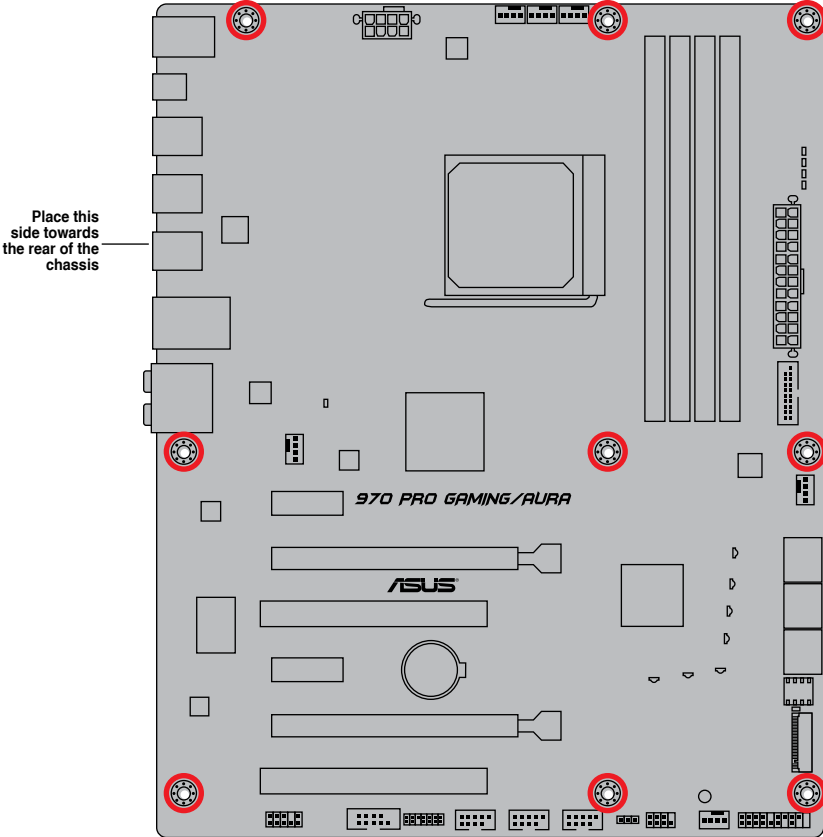

1.2.3 Motherboard layout

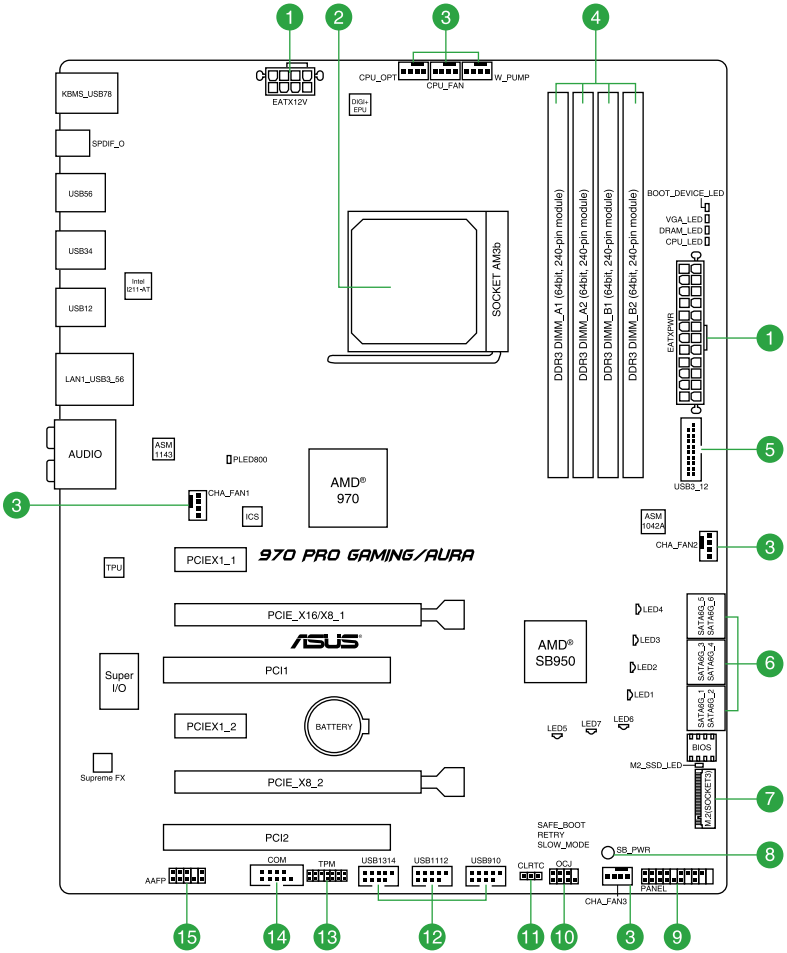

1.2.4 Layout contents

Connectors/Jumpers/Slots/LED		Page
1.	ATX power connectors (24-pin EATXPWR, 8-pin EATX12V)	1-19
2.	AMD AM3+ socket	1-5
3.	CPU, CPU optional, water pump, and chassis fan connectors (4-pin CPU_FAN, 4-pin CPU_OPT, 4-pin w_PUMP, 4-pin CHA_FAN1-3)	1-20
4.	DDR3 DIMM slots	1-9
5.	USB 3.0 connector (20-1 pin USB3_12)	1-22
6.	AMD SB950 Serial ATA 6.0Gb/s connector (SATA6G_1~6 [black])	1-23
7.	M.2 (Socket 3)	1-25
8.	Standby Power LED (SB_PWR)	1-26
9.	System panel connector (20-5 pin PANEL)	1-24
10.	Overclocking Jack (8-1 pin OCJ)	1-16
11.	Clear RTC RAM (3-pin CLRTC)	1-19
12.	USB 2.0 connector (10-1 pin USB910, USB1112, USB1314)	1-22
13.	TPM connector (14-1 pin TPM)	1-21
14.	Serial port connector (10-1 pin COM)	1-20
15.	Front panel audio connector (10-1 pin AAFP)	1-21

1.3 Central Processing Unit (CPU)

This motherboard comes with an AMD AM3+ socket designed for AMD® FX™/Phenom™ II/ Athlon™ II/Sempron™ 100 Series Processors.



The AM3+ socket has a different pinout from the AM2+/AM2 socket. Ensure that you use a CPU designed for the AM3+ socket. The CPU fits in only one correct orientation. **DO NOT** force the CPU into the socket to prevent bending the pins and damaging the CPU!

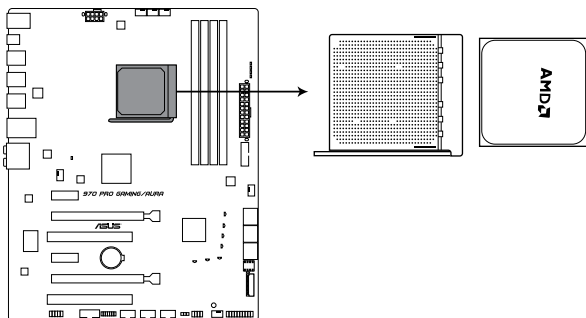

970 PRO GAMING/AURA CPU AM3+



Unplug all power cables before installing the CPU.

1.3.1 Installing the CPU

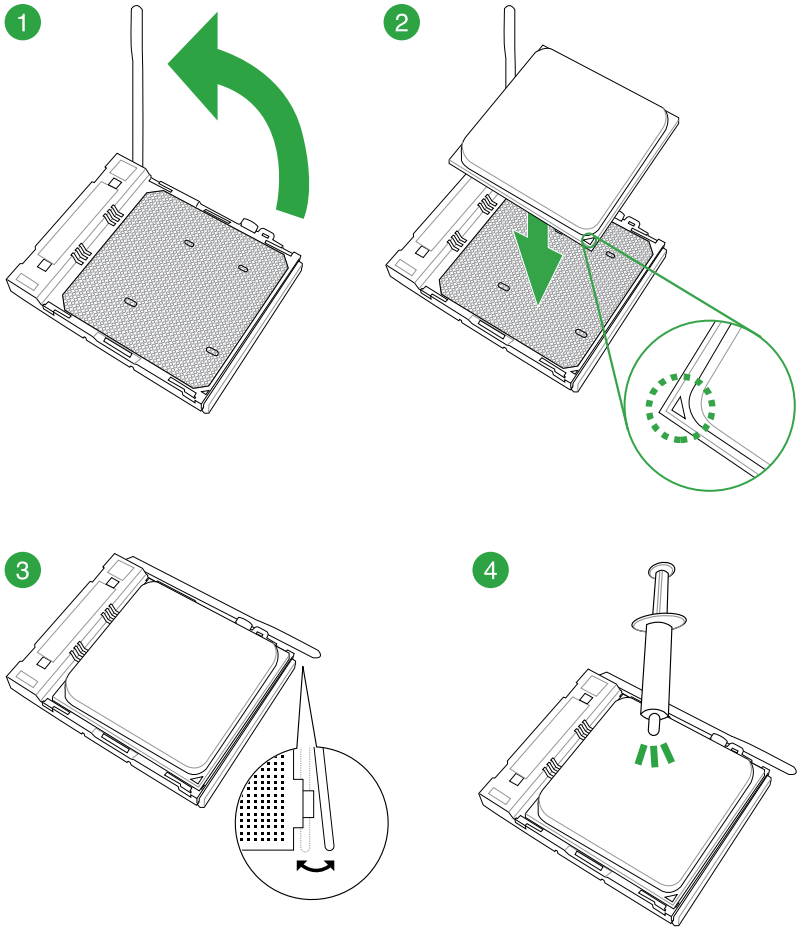

1.3.2 CPU heatsink and fan assembly installation

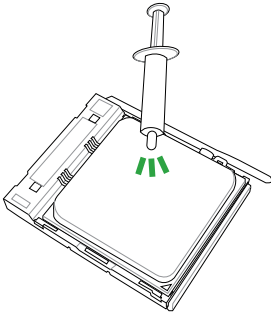

Apply the Thermal Interface Material to the CPU heatsink and CPU before you install the heatsink and fan if necessary.

To install the CPU heatsink and fan assembly

1

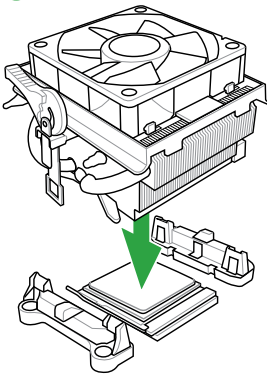

2

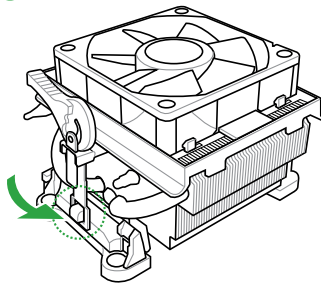

3

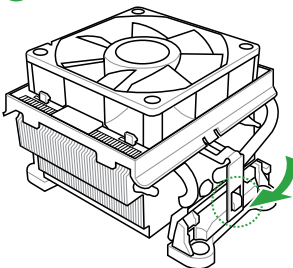

4

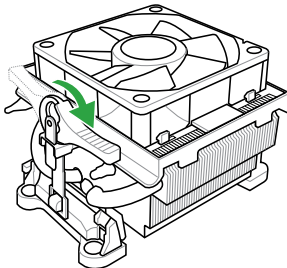

5

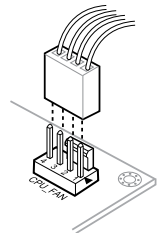

To uninstall the CPU heatsink and fan assembly

1

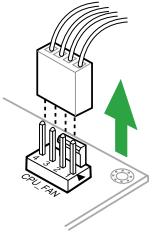

2

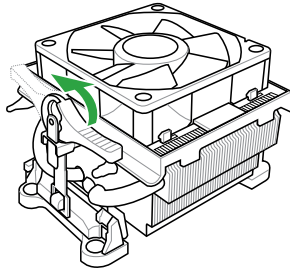

3

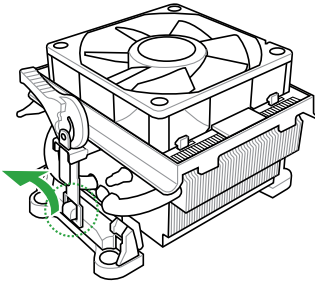

4

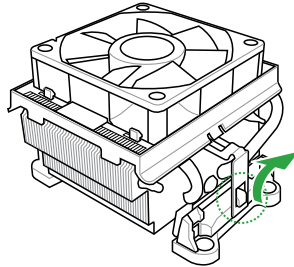

5

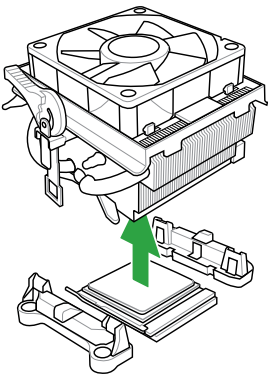

1.4 System memory

1.4.1 Overview

This motherboard comes with four (4) Double Data Rate 3 (DDR3) Dual Inline Memory Module (DIMM) sockets. A DDR3 module is notched differently from a DDR or DDR2 module. DO NOT install a DDR or DDR2 memory module to the DDR3 slot.



To prevent system instability, either install DDR3L DIMMs or DDR3 DIMMs with voltage lower than 1.5V.

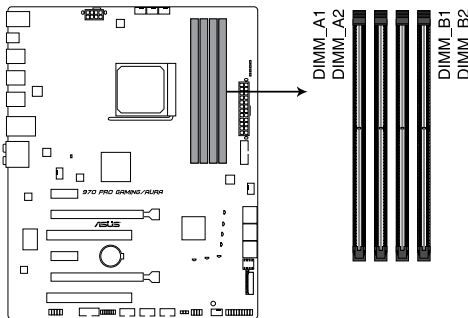

Channel	Sockets
Channel A	DIMM_A1 & DIMM_A2
Channel B	DIMM_B1 & DIMM_B2

970 PRO GAMING/AURA 240-pin DDR3 DIMM socket

Recommended memory configurations

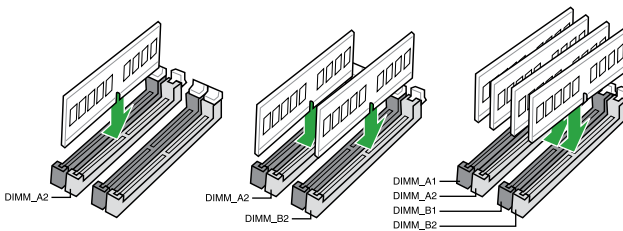

1.4.2 Memory configurations

You may install 1GB, 2GB, 4GB, and 8GB unbuffered non-ECC DDR3 DIMMs into the DIMM sockets.

Visit the ASUS website at www.asus.com for the latest QVL.



-
- You may install varying memory sizes in Channel A and Channel B. The system maps the total size of the lower-sized channel for the dual-channel configuration. Any excess memory from the higher-sized channel is then mapped for single-channel operation.
 - Always install DIMMs with the same CAS latency. For optimal compatibility, we recommend that you install memory modules of the same version or date code (D/C) from the same vendor. Check with the retailer to get the correct memory modules.
 - Due to the memory address limitation on 32-bit Windows® OS, when you install 4GB or more memory on the motherboard, the actual usable memory for the OS can be about 3GB or less. For effective use of memory, we recommend that you do any of the following:
 - Use a maximum of 3GB system memory if you are using a 32-bit Windows® OS.
 - Install a 64-bit Windows® OS if you want to install 4GB or more on the motherboard.
 - This motherboard does not support DIMMs made up of 512 megabits (Mb) chips or less.
-

1.4.3 Installing a DIMM

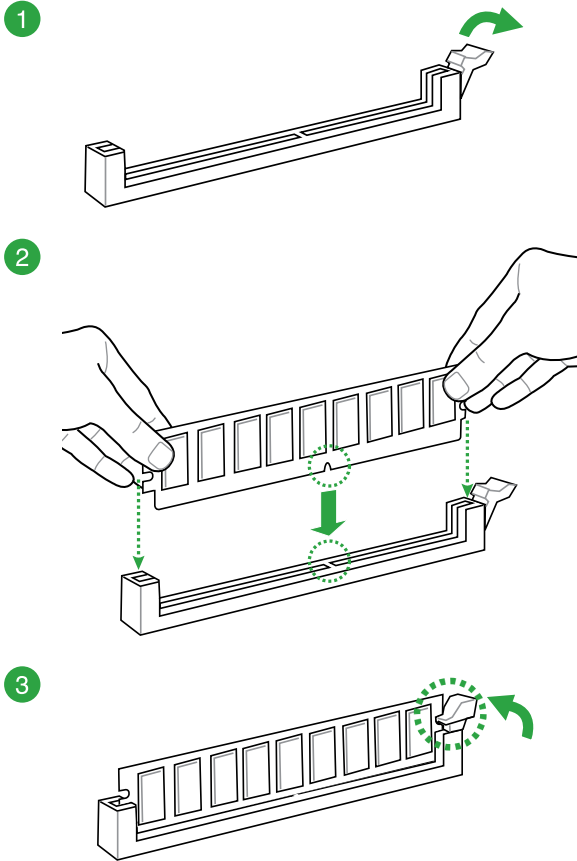

To remove a DIMM

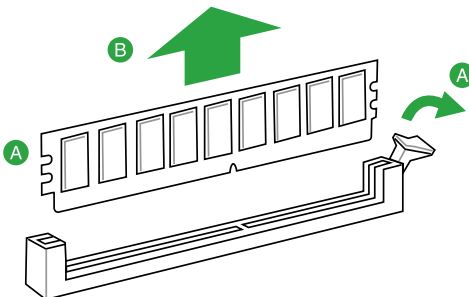

1.5 Expansion slots

In the future, you may need to install expansion cards. The following sub-sections describe the slots and the expansion cards that they support.



Unplug the power cord before adding or removing expansion cards. Failure to do so may cause you physical injury and damage motherboard components.

1.5.1 Installing an expansion card

To install an expansion card:

1. Before installing the expansion card, read the documentation that came with it and make the necessary hardware settings for the card.
2. Remove the system unit cover (if your motherboard is already installed in a chassis).
3. Remove the bracket opposite the slot that you intend to use. Keep the screw for later use.
4. Align the card connector with the slot and press firmly until the card is completely seated on the slot.
5. Secure the card to the chassis with the screw you removed earlier.
6. Replace the system cover.

1.5.2 Configuring an expansion card

After installing the expansion card, configure it by adjusting the software settings.

1. Turn on the system and change the necessary BIOS settings, if any. See Chapter 2 for information on BIOS setup.
2. Assign an IRQ to the card.
3. Install the software drivers for the expansion card.



When using PCI cards on shared slots, ensure that the drivers support "Share IRQ" or that the cards do not need IRQ assignments. Otherwise, conflicts will arise between the two PCI groups, making the system unstable and the card inoperable.

1.5.3 PCI Express 2.0 slots

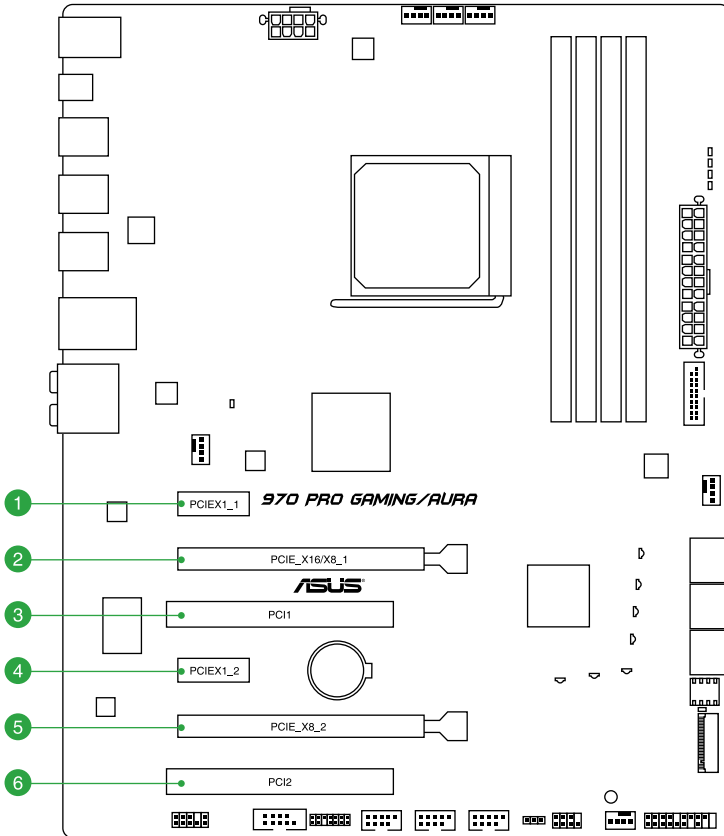

Slot No.	Expansion slot
1	PCIe 2.0 x1_1 slot
2	PCIe 2.0 x16/x8_1 slot
3	PCI 1
4	PCIe 2.0 x1_2 slot
5	PCIe 2.0 x8_2 slot
6	PCI 2

PCI Express 2.0 operating mode		
VGA configuration	PCIe 2.0 x16/x8_1	PCIe 2.0 x8_2
Single VGA/PCIe card	x16 (single VGA recommended)	N/A
Dual VGA/PCIe card	x8	x8



-
- We recommend that you provide sufficient power when running CrossFireX™ mode.
 - Connect a chassis fan to the motherboard connector labeled CHA_FAN1-3 when using multiple graphics cards for better thermal environment.
-

IRQ assignments for this motherboard

	A	B	C	D	E	F	G	H
PCIEX1_1	-	-	-	-	-	-	-	shared
PCIEX16/X8_1	shared	-	-	-	-	-	-	-
PCI1	-	-	-	-	shared	-	-	-
PCIEX1_2	shared	-	-	-	-	-	-	-
PCIEX8_2	-	-	-	-	shared	-	-	-
PCI2	-	-	-	-	-	shared	-	-
M.2 PCIe X4 SLOT	-	-	-	-	shared	-	-	-
HD Audio	shared	-	-	-	-	-	-	-
Intel LAN Controller	-	-	shared	-	-	-	-	-
SATA Controller	-	-	-	shared	-	-	-	-
USB 1.1 Controller 1	-	-	shared	-	-	-	-	-
USB 1.1 Controller 2	-	-	-	-	shared	-	-	-
USB 1.1 Controller 3	-	-	-	-	-	-	shared	-
USB 1.1 Controller 4	-	-	shared	-	-	-	-	-
USB 2.0 Controller 1	-	shared	-	-	-	-	-	-
USB 2.0 Controller 2	-	-	-	-	-	shared	-	-
USB 2.0 Controller 3	-	-	-	-	-	-	-	shared
Asmedia USB 3.1 Controller	shared	-	-	-	-	-	-	-
Asmedia USB 3.0 Controller	-	shared	-	-	-	-	-	-

1.6 Jumpers

1. Clear RTC RAM (3-pin CLRRTC)

This jumper allows you to clear the Real Time Clock (RTC) RAM in CMOS. You can clear the CMOS memory of date, time, and system setup parameters by erasing the CMOS RTC RAM data. The onboard button cell battery powers the RAM data in CMOS, which include system setup information such as system passwords.

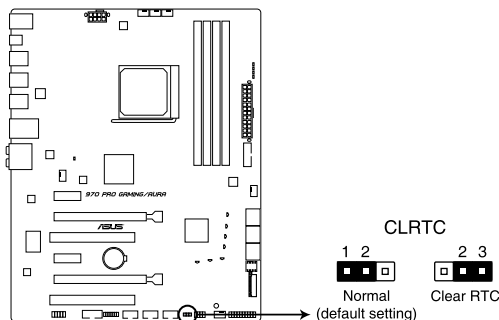

970 PRO GAMING/AURA Clear RTC RAM

To erase the RTC RAM:

1. Turn OFF the computer and unplug the power cord.
2. Move the jumper cap from pins 1–2 (default) to pins 2–3. Keep the cap on pins 2–3 for about 5–10 seconds, then move the cap back to pins 1–2.
3. Plug the power cord and turn ON the computer.
4. Hold down the key during the boot process and enter BIOS setup to reenter data.



Except when clearing the RTC RAM, never remove the cap on CLRRTC jumper default position. Removing the cap will cause system boot failure!



- If the steps above do not help, remove the onboard battery and short the two pins again to clear the CMOS RTC RAM data. After clearing the CMOS, reinstall the battery.
- You do not need to clear the RTC when the system hangs due to overclocking. For system failure due to overclocking, use the CPU Parameter Recall (C.P.R.) feature. Shut down and reboot the system, then the BIOS automatically resets parameter settings to default values.
- Due to chipset behavior, AC power off is required to enable C.P.R. function. You must turn off and on the power supply or unplug and plug the power cord before rebooting the system.

2. Overclocking Jack (8-1 pin OCJ)

These jumpers support the overclocking features ReTry, Safe Boot and Slow Mode. Short-circuit the corresponding pins with a metal object or jumper cap for about 5-10 seconds to use its function.

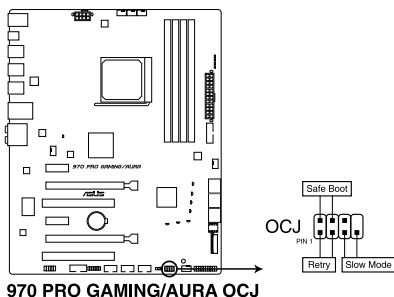

- **ReTry**

ReTry is used during the booting process where the Reset button is rendered useless. It forces the system to reboot while retaining the same settings to be retried in quick succession to achieve a successful POST.

- **Safe Boot**

Safe Boot is used to force the system to reboot into the BIOS safe mode. It temporarily applies safe settings to the BIOS while retaining any overclocked settings allowing you to modify the settings causing boot failure.

- **Slow Mode**

Slow Mode is employed during LN2 benching. Some processors have a small optimum temperature range to run at their highest frequency. Temperatures that fall outside this band may yield instability. For example, a processor may need to operate at -80°C under load and only 75°C when idle to maintain stability at 5GHz.

At lower frequencies, the CPU's temperature tolerance increases. It will however remain stable at lower frequencies at much colder or warmer temperatures. Once it comes out of a heavy load while transitioning over to a light load, when the temperature does not warm fast enough, it may crash. To overcome this, simply short the 2-pins to decrease the processor frequency. Switching over to Slow-Mode during critical moments when Temperature/Max Frequency alignment is off-sync can prevent a lot of crashes, even when trying to boot into the OS at cold temperatures.

1.7 Connectors

1.7.1 Rear panel connectors

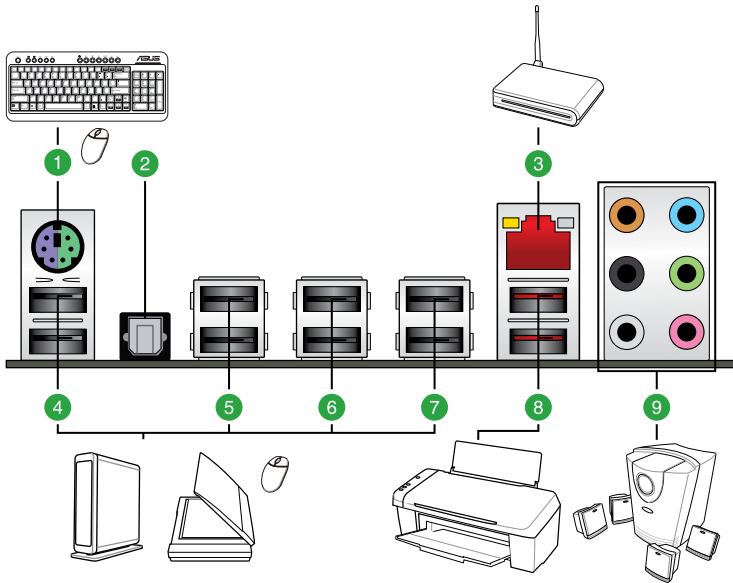

Rear panel connectors

1.	PS/2 Keyboard/Mouse combo port	6.	USB 2.0 ports 34
2.	Optical S/PDIF OUT port	7.	USB 2.0 ports 12
3.	LAN (RJ-45) port*	8.	USB 3.1 ports
4.	USB 2.0 ports 78	9.	Audio I/O ports**
5.	USB 2.0 ports 56		

* and **: Refer to the tables on the next page for LAN port LEDs and audio port definitions.



- Due to USB 3.0 controller limitations, USB 3.0 devices can only be used under a Windows® OS environment and after USB 3.0 driver installation.
- The plugged USB 3.0 device may run on xHCI or EHCI mode, depending on the operating system's setting.
- USB 3.0 devices can only be used for data storage.
- We strongly recommend that you connect USB 3.0 devices to USB 3.0 ports for faster and better performance from your USB 3.0 devices.

*LAN port LED indications

Activity/Link LED		Speed LED	
Status	Description	Status	Description
Off	No link	OFF	10Mbps connection
Orange	Linked	ORANGE	100Mbps connection
Orange (Blinking)	Data activity	GREEN	1Gbps connection
Orange (Blinking then steady)	Ready to wake up from S5 mode		

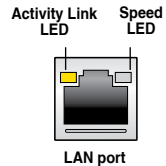

** Audio 2, 4, 6, or 8-channel configuration

Port	Headset 2-channel	4-channel	6-channel	8-channel
Light Blue	Line In	Line In	Line In	Line In
Lime	Line Out	Front Speaker Out	Front Speaker Out	Front Speaker Out
Pink	Mic In	Mic In	Mic In	Mic In
Orange	–	–	Center/Subwoofer	Center/Subwoofer
Black	–	Rear Speaker Out	Rear Speaker Out	Rear Speaker Out
Gray	–	–	–	Side Speaker Out

1.7.2 Internal connectors

1. ATX power connectors (24-pin EATXPWR, 8-pin EATX12V)

These connectors are for ATX power supply plugs. The power supply plugs are designed to fit these connectors in only one orientation. Find the proper orientation and push down firmly until the connectors completely fit.

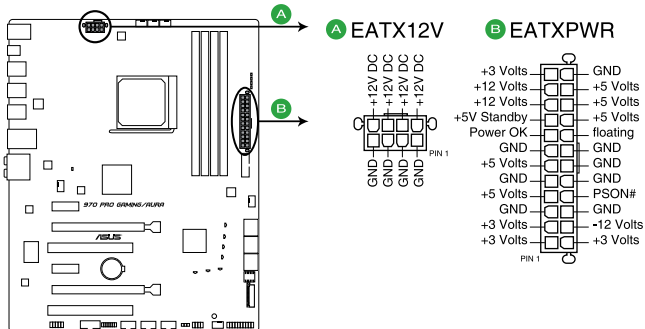

970 PRO GAMING/AURA ATX power connectors



- For a fully configured system, we recommend that you use a power supply unit (PSU) that complies with ATX 12V specification 2.4 (or later version) and provides a minimum power of 350W
- We recommend that you use a PSU with higher power output when configuring a system with more power-consuming devices or when you intend to install additional devices. The system may become unstable or may not boot up if the power is inadequate.

2. CPU, CPU optional, Water pump, and chassis fan connectors (4-pin CPU_FAN, 4-pin CPU_OPT, 4-Pin W_PUMP, 4-pin CHA_FAN1-3)

Connect the fan cables to the fan connectors on the motherboard, ensuring that the black wire of each cable matches the ground pin of the connector.

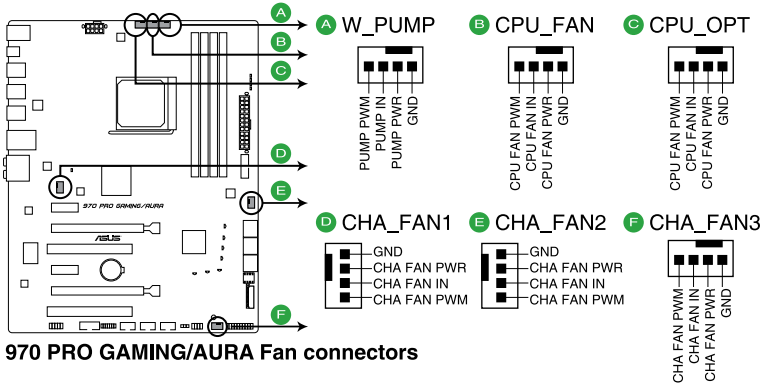

DO NOT forget to connect the fan cables to the fan connectors. Insufficient air flow inside the system may damage the motherboard components. These are not jumpers! Do not place jumper caps on the fan connectors! The CPU_FAN connector supports a CPU fan of maximum 1A (12 W) fan power.

3. Serial port connector (10-1 pin COM)

This connector is for a serial (COM) port. Connect the serial port module cable to this connector, then install the module to a slot opening at the back of the system chassis.

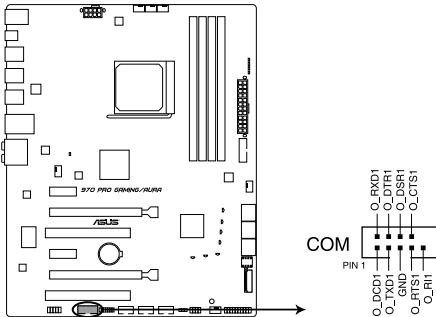

The COM module is purchased separately.

4. Front panel audio connector (10-1 pin AAFP)

This connector is for a chassis-mounted front panel audio I/O module that supports either HD Audio or legacy AC'97 audio standard. Connect one end of the front panel audio I/O module cable to this connector.

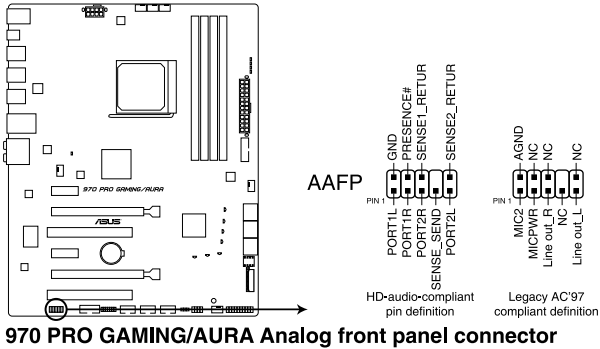

- We recommend that you connect a high-definition front panel audio module to this connector to avail of the motherboard's high-definition audio capability.
- If you want to connect a high-definition front panel audio module to this connector, set the Front Panel Type item in the BIOS setup to [HD Audio]. If you want to connect an AC'97 front panel audio module to this connector, set the item to [AC97]. By default, this connector is set to [HD Audio].

5. TPM connector (14-1 pin TPM)

This connector supports a Trusted Platform Module (TPM) system, which can securely store keys, digital certificates, passwords, and data. A TPM system also helps enhance network security, protects digital identities, and ensures platform integrity.

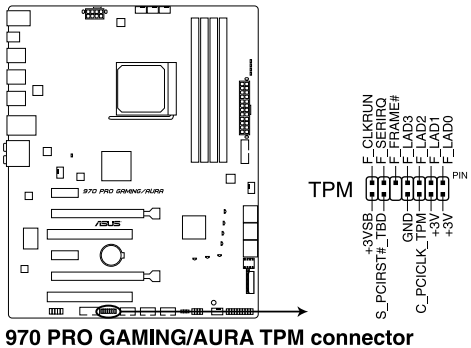

The TPM module is purchased separately.

6. USB 2.0 connector (10-1 pin USB910, USB1112, USB1314)

These connectors are for USB 2.0 ports. Connect the USB module cable to any of these connectors, then install the module to a slot opening at the back of the system chassis. These USB connectors comply with USB 2.0 specifications and supports up to 480Mbps connection speed.

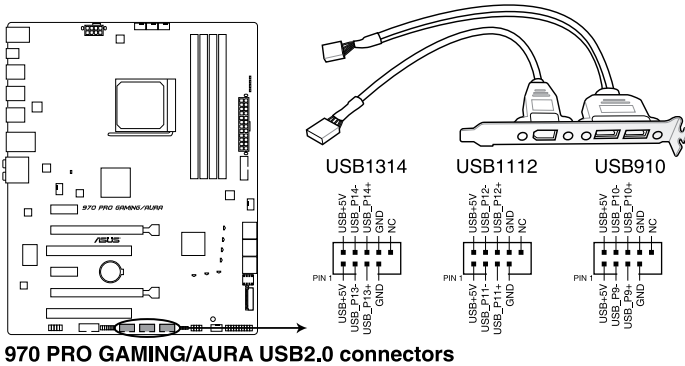

Never connect a 1394 cable to the USB connectors. Doing so will damage the motherboard!



The USB 2.0 module is purchased separately.

7. USB 3.0 connector (20-1 pin USB3_12)

These connectors allow you to connect a USB 3.0 module for additional USB 3.0 front or rear panel ports. With an installed USB 3.0 module, you can enjoy all the benefits of USB 3.0 including faster data transfer speeds of up to 5Gbps, faster charging time for USB-chargeable devices, optimized power efficiency and backward compatibility with USB 2.0.

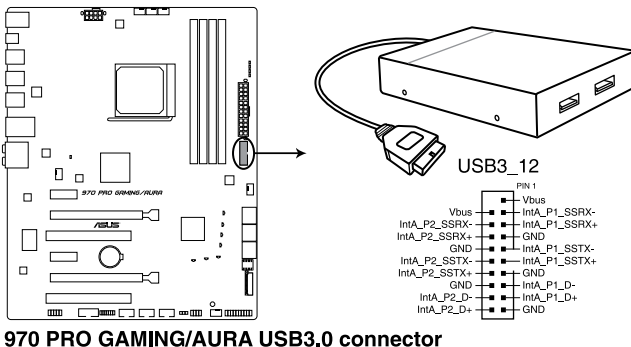

8. AMD SB950 Serial ATA 6.0Gb/s connectors (7-pin SATA6G_1~6 [black])

These connectors connect to Serial ATA 6.0 Gb/s hard disk drives via Serial ATA 6.0 Gb/s signal cables.

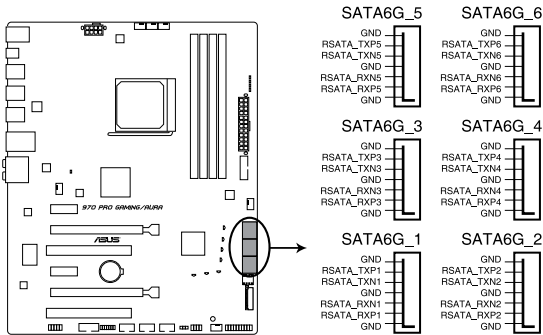

970 PRO GAMING/AURA Intel® SATA 6 Gb/s connectors

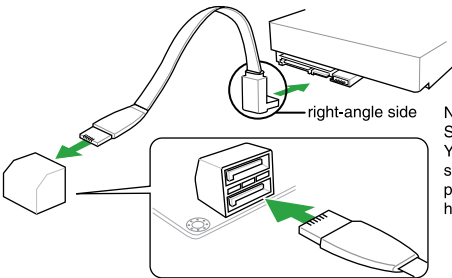

NOTE: Connect the right-angle side of SATA signal cable to SATA device. You may also connect the right-angle side of SATA cable to the onboard SATA port to avoid mechanical conflict with huge graphics cards.

9. System panel connector (20-5 pin PANEL)

This connector supports several chassis-mounted functions.

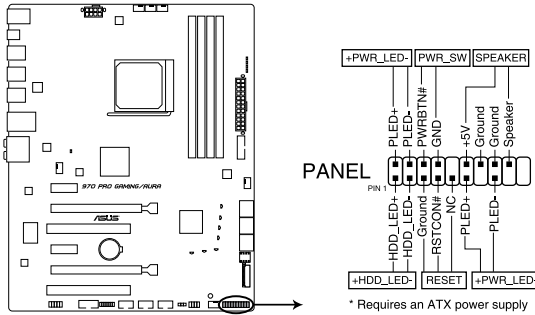

- **System power LED (4-pin +PWR_LED-)**

This 4-pin connector is for the system power LED. Connect the chassis power LED cable to this connector. The system power LED lights up when you turn on the system power, and blinks when the system is in sleep mode.

- **Hard disk drive activity LED (2-pin +HDD_LED-)**

This 2-pin connector is for the HDD Activity LED. Connect the HDD Activity LED cable to this connector. The HDD LED lights up or flashes when data is read from or written to the HDD.

- **System warning speaker (4-pin SPEAKER)**

This 4-pin connector is for the chassis-mounted system warning speaker. The speaker allows you to hear system beeps and warnings.

- **ATX power button/soft-off button (2-pin PWR_SW)**

This connector is for the system power button. Pressing the power button turns the system on or puts the system in sleep or soft-off mode depending on the operating system settings. Pressing the power switch for more than four seconds while the system is ON turns the system OFF.

- **Reset button (2-pin RESET)**

This 2-pin connector is for the chassis-mounted reset button for system reboot without turning off the system power.

10. M.2 (Socket 3)

The M.2 (Socket 3) with M Key supports type 2242 (22mm x 42mm), 2260 (22mm x 60mm), and 2280 (22mm x 80mm) PCIe interface storage devices.

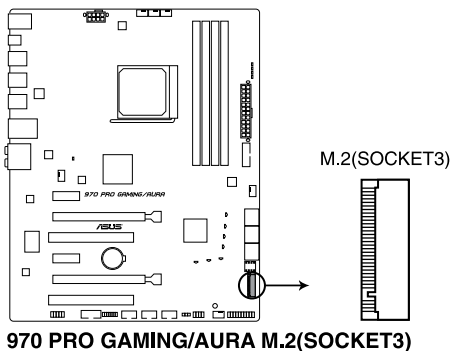

M.2 only supports data storage.

1.8 Onboard LEDs

1. Standby Power LED (SB_PWR)

The motherboard comes with a standby power LED that lights up to indicate that the system is ON, in sleep mode, or in soft-off mode. This is a reminder that you should shut down the system and unplug the power cable before removing or plugging in any motherboard component. The illustration below shows the location of the onboard LED.

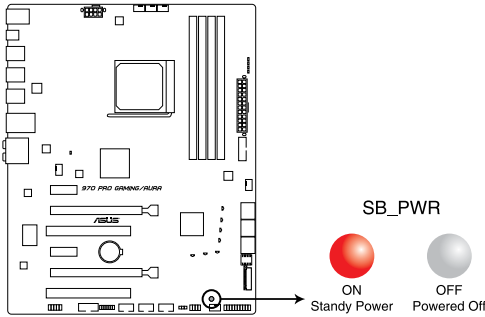

970 PRO GAMING/AURA Onboard LED

2. Q LEDs (BOOT_DEVICE_LED; VGA_LED; DRAM_LED; CPU_LED)

Q LEDs check key components (CPU, DRAM, VGA card, and booting devices) in sequence during motherboard booting process. If an error is found, the corresponding LED flashes until the problem is solved. This user-friendly design provides an intuitive way to locate the root problem within seconds.

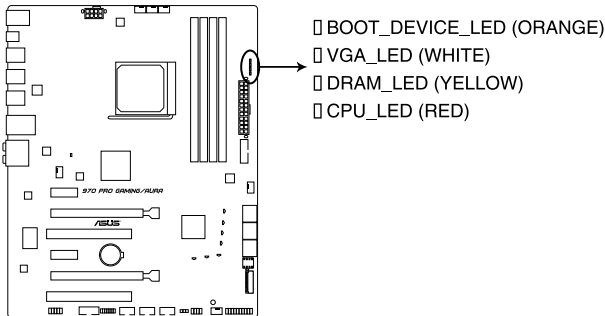

**970 PRO GAMING/AURA CPU/ DRAM/
BOOT_DEVICE/ VGA LED**

3. M2 LED (M2_SSD_LED)

This LED lights up to indicate that the installed M.2 (NGFF) card is being accessed.

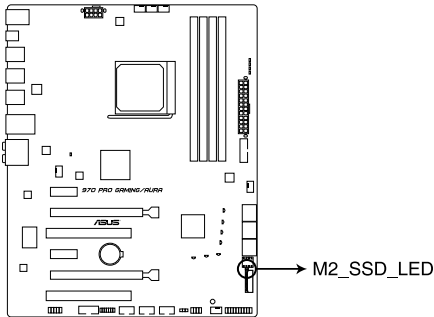

970 PRO GAMING/AURA M2_SSD_LED

4. RGB LED

The RGB LED lighting control provides several lighting schemes, which allow you to customize your favorite LED effect. You can set your favorite LED effect to cast a stunning multi-color glow across your build, change shades to indicate CPU temperature, or pulsate in time to the beat of your music.

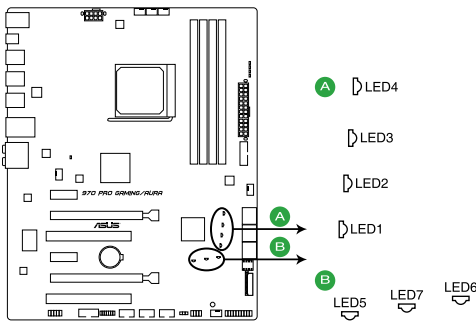

970 PRO GAMING/AURA LED



You can change the lighting schemes from the LED Control app named Aura.

BIOS Information

2

2.1 Managing and updating your BIOS



Save a copy of the original motherboard BIOS file to a USB flash disk in case you need to restore the BIOS in the future. Copy the original motherboard BIOS using the ASUS Update utility.

2.1.1 EZ Update

EZ Update is a utility that allows you to automatically update your motherboard's softwares, drivers and the BIOS version easily. With this utility, you can also manually update the saved BIOS and select a boot logo when the system goes into POST.

To launch EZ Update, click **EZ Update** on the AI Suite 3 main menu bar.

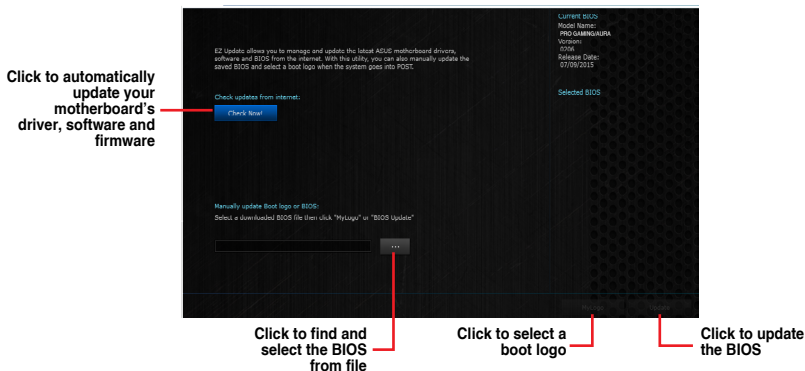

EZ Update requires an Internet connection either through a network or an ISP (Internet Service Provider).

2.1.2 ASUS EZ Flash 2 Utility

The ASUS EZ Flash 2 feature allows you to update the BIOS without using an OS-based utility. Press <Enter> to launch the EZ Flash 2 screen.



Before you start using this utility, download the latest BIOS file from the ASUS website at www.asus.com.

To update the BIOS using EZ Flash 2:

1. Insert the USB flash disk that contains the latest BIOS file to the USB port.
2. Enter the **Advanced Mode** of the BIOS setup program. Go to the **Tool** menu to select **ASUS EZ Flash Utility** and press <Enter>.
3. Press <Tab> to switch to the **Drive** field.
4. Press the Up/Down arrow keys to find the USB flash disk that contains the latest BIOS then press <Enter>.
5. Press <Tab> to switch to the **Folder Info** field.
6. Press the Up/Down arrow keys to find the BIOS file then press <Enter> to perform the BIOS update process. Reboot the system when the update process is done.



-
- This function supports USB flash disks formatted using FAT32 or FAT16 on a single partition only.
 - Ensure to load the BIOS default settings to ensure system compatibility and stability. Select the **Load Optimized Defaults** item under the **Exit** menu.
 - DO NOT shut down or reset the system while updating the BIOS to prevent system boot failure!
-

2.1.3 ASUS CrashFree BIOS 3 utility

The ASUS CrashFree BIOS 3 is an auto recovery tool that allows you to restore the BIOS file when it fails or gets corrupted during the updating process. You can restore a corrupted BIOS file using the motherboard support DVD or a USB flash drive that contains the updated BIOS file.



- Before using this utility, rename the BIOS file in the removable device into **970PGMA.CAP**.
- The BIOS file in the support DVD may not be the latest version. Download the latest BIOS file from the ASUS website at www.asus.com.

Recovering the BIOS

To recover the BIOS:

1. Turn on the system.
2. Insert the support DVD to the optical drive or the USB flash drive that contains the BIOS file to the USB port.
3. The utility automatically checks the devices for the BIOS file. When found, the utility reads the BIOS file and enters ASUS EZ Flash 3 utility automatically.
4. The system requires you to enter BIOS Setup to recover BIOS settings. To ensure system compatibility and stability, we recommend that you press <F5> to load default BIOS values.



DO NOT shut down or reset the system while updating the BIOS! Doing so can cause system boot failure!

2.1.4 ASUS BIOS Updater

ASUS BIOS Updater allows you to update the BIOS in DOS environment.



The screen captures used in this section are for reference only and may not be exactly the same as actually shown on your computer screen.

Before updating BIOS

- Prepare the motherboard support DVD and a USB flash drive.
- Download the latest BIOS file and BIOS Updater from <https://www.asus.com/support/> and save them in your USB flash drive.



NTFS is not supported under FreeDOS environment. Ensure that your USB flash drive is in single partition and in FAT32/16 format.

- Turn off the computer.
- Ensure that your computer has a DVD optical drive.

Booting the system in DOS environment

To boot the system in DOS:

1. Insert the USB flash drive with the latest BIOS file and BIOS Updater to the USB port.
2. Boot your computer then press <F8> to launch the select boot device screen.
3. When the select boot device screen appears, insert the Support DVD into the optical drive then select the optical drive as the boot device.

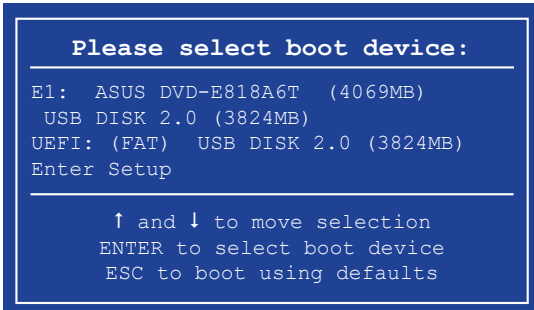

4. When the booting message appears, press <Enter> within five (5) seconds to enter FreedOS prompt.

```
ISOLINUX 3.20 2006-08-26 Copyright (C) 1994-2005 H. Peter Anvin
A Bootable DVD/CD is detected. Press ENTER to boot from the DVD/CD.
If no key is pressed within 5 seconds, the system will boot next priority
device automatically. boot:
```

5. On the FreedOS prompt, type **d:** then press <Enter> to switch the disk from Drive C (optical drive) to Drive D (USB flash drive).

```
Welcome to FreeDOS (http://www.freedos.org)!
C: /> d:
D: />
```

Updating the BIOS file

To update the BIOS file:

1. On the FreeDOS prompt, type **bupdater /pc /g** and press <Enter>.

```
D: /> bupdater /pc /g
```

2. On the BIOS Updater screen, press <Tab> to switch from Files panel to Drives panel then select **D:**.

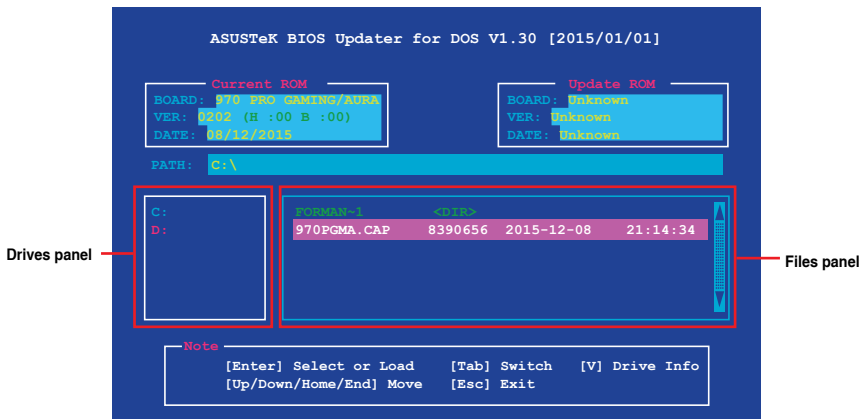

3. Press <Tab> to switch from Drives panel to Files panel then press <Up/Down or Home/End> keys to select the BIOS file and press <Enter>.
4. After the BIOS Updater checks the selected BIOS file, select **Yes** to confirm the BIOS update.

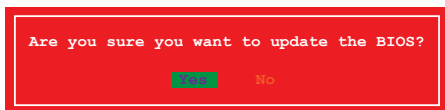

The BIOS Backup feature is not supported due to security regulations.

5. Select **Yes** then press <Enter>. When BIOS update is done, press <ESC> to exit BIOS Updater.
6. Restart your computer.



DO NOT shut down or reset the system while updating the BIOS to prevent system boot failure.



Ensure to load the BIOS default settings to ensure system compatibility and stability. Select the **Load Optimized Defaults** item under the **Exit BIOS** menu.

2.2 BIOS setup program

Use the BIOS Setup program to update the BIOS or configure its parameters. The BIOS screens include navigation keys and brief online help to guide you in using the BIOS Setup program.

Entering BIOS Setup at startup

To enter BIOS Setup at startup:

- Press <Delete> or <F2> during the Power-On Self Test (POST). If you do not press <Delete> or <F2>, POST continues with its routines.

Entering BIOS Setup after POST

To enter BIOS Setup after POST:

- Press <Ctrl>+<Alt>+ simultaneously.
- Press the reset button on the system chassis.
- Press the power button to turn the system off then back on. Do this option only if you failed to enter BIOS Setup using the first two options.



Using the power button, reset button, or the <Ctrl>+<Alt>+ keys to force reset from a running operating system can cause damage to your data or system. We recommend you always shut down the system properly from the operating system



-
- The BIOS setup screens shown in this section are for reference purposes only, and may not exactly match what you see on your screen.
 - Visit the ASUS website at www.asus.com to download the latest BIOS file for this motherboard.
 - If the system becomes unstable after changing any BIOS setting, load the default settings to ensure system compatibility and stability. Select the **Load Optimized Defaults** item under the Exit menu or press hotkey <F5>.
 - If the system fails to boot after changing any BIOS setting, try to clear the CMOS and reset the motherboard to the default value. See section 1.6 **Jumpers** for information on how to erase the RTC RAM.
-

BIOS menu screen

The BIOS setup program can be used under two modes: **EZ Mode** and **Advanced Mode**. You can change modes from the **Exit** menu or from the **Exit/Advanced Mode** button in the EZ Mode/Advanced Mode screen.

EZ Mode

By default, the EZ Mode screen appears when you enter the BIOS setup program. The EZ Mode provides you an overview of the basic system information, and allows you to select the display language, system performance mode and boot device priority. To access the Advanced Mode, click **Exit/Advanced Mode**, then select **Advanced Mode** or press <F7> for the advanced BIOS settings.



The default screen for entering the BIOS setup program can be changed.

Displays the CPU/motherboard temperature, CPU voltage output, and CPU/chassis fan speed

Selects the display language of the BIOS setup program

Exits the BIOS setup program without saving the changes, saves the changes and resets the system, or enters the Advanced Mode

Selects the boot device priority

Power saving mode

Selects the Advanced mode functions

Normal mode

Displays the Advanced mode menus

ASUS Optimal mode

Selects the boot device priority

Loads optimized default

Displays the system properties of the selected mode



- The boot device options vary depending on the devices you installed to the system.
- The **Boot Menu(F8)** button is available only when the boot device is installed to the system.

Advanced Mode

The Advanced Mode provides advanced options for experienced end-users to configure the BIOS settings. The figure below shows an example of the **Advanced Mode**.



To access the EZ Mode, click **Exit**, then select **ASUS EZ Mode** or press **<F7>**.

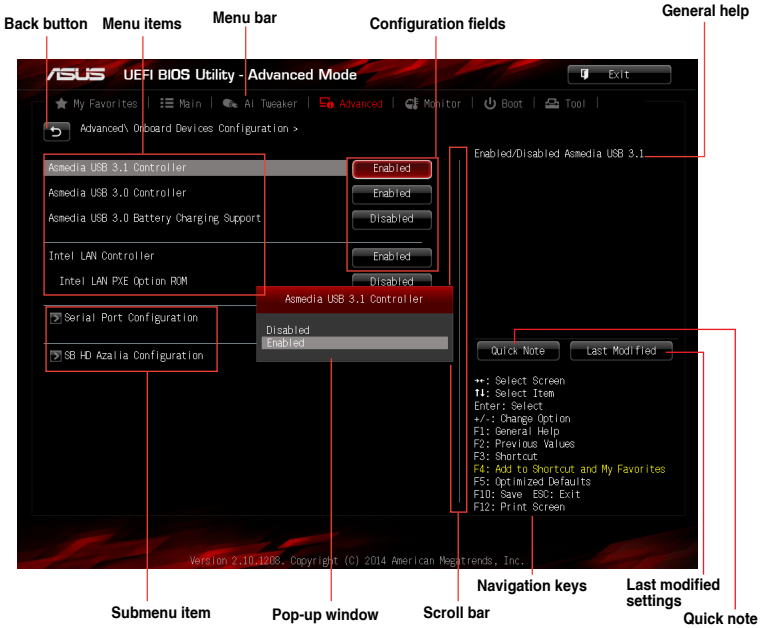

Menu bar

The menu bar on top of the screen has the following main items:

My Favorites	For saving the frequently-used system settings and configuration
Main	For changing the basic system configuration
Ai Tweaker	For changing the overclocking settings
Advanced	For changing the advanced system settings
Monitor	For displaying the system temperature, power status, and changing the fan settings
Boot	For changing the system boot configuration
Tool	For configuring options for special functions
Exit	For selecting the exit options and loading default settings

Menu items

The highlighted item on the menu bar displays the specific items for that menu. For example, selecting **Main** shows the Main menu items.

The other items (Ai Tweaker, Advanced, Monitor, Boot, Tool, and Exit) on the menu bar have their respective menu items.

Back button

This button appears when entering a submenu. Press <Esc> or use the USB mouse to click this button to return to the previous menu screen.

Submenu items

A greater than sign (>) before each item on any menu screen means that the item has a submenu. To display the submenu, select the item and press <Enter>.

Pop-up window

Select a menu item and press <Enter> to display a pop-up window with the configuration options for that item.

Scroll bar

A scroll bar appears on the right side of a menu screen when there are items that do not fit on the screen. Press the Up/Down arrow keys or <Page Up> / <Page Down> keys to display the other items on the screen.

Navigation keys

At the bottom right corner of the menu screen are the navigation keys for the BIOS setup program. Use the navigation keys to select items in the menu and change the settings.

General help

At the top right corner of the menu screen is a brief description of the selected item.

Configuration fields

These fields show the values for the menu items. If an item is user-configurable, you can change the value of the field opposite the item. You cannot select an item that is not user-configurable.

A configurable field is highlighted when selected. To change the value of a field, select it and press <Enter> to display a list of options.

Quick Note button

This button allows you to enter notes of the activities that you have done in BIOS.

Last Modified button

This button shows the items that you last modified and saved in BIOS Setup.

2.3 My Favorites

MyFavorites is your personal space where you can easily save and access your favorite BIOS items.

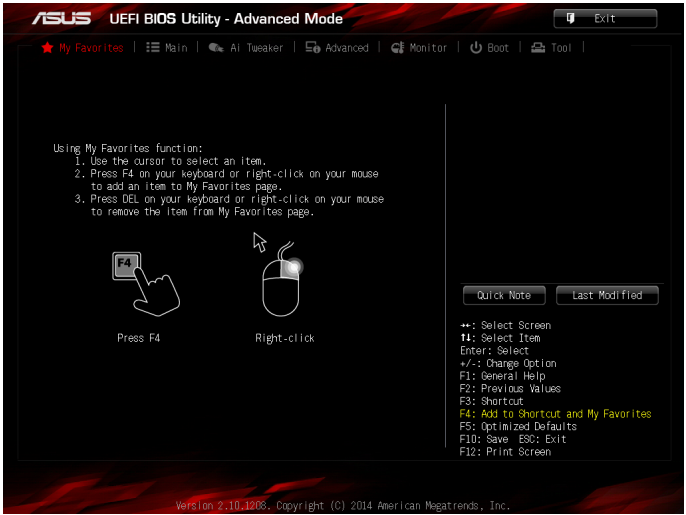

Adding items to My Favorites

To add frequently-used BIOS items to My Favorites:

1. Use the arrow keys to select an item that you want to add. When using a mouse, hover the pointer to the item.
2. Press <F4> on your keyboard or right-click on your mouse to add the item to My Favorites page.



You cannot add the following items to My Favorites:

- Items with submenu options
 - User-configurable items such as language and boot device order
 - Configuration items such as Memory SPD Information, system time and date
-

2.4 Main menu

The Main menu screen appears when you enter the Advanced Mode of the BIOS Setup program. The Main menu provides you an overview of the basic system information, and allows you to set the system date, time, language, and security settings.

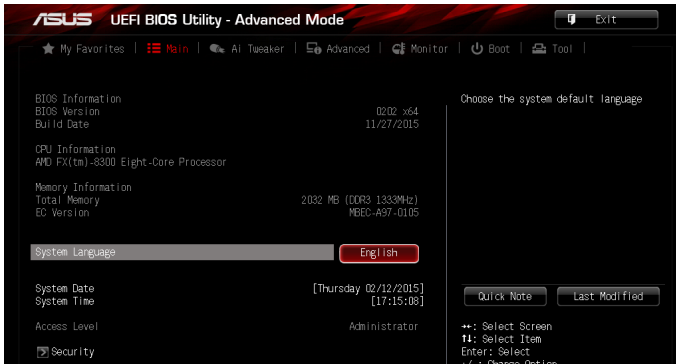

System Language [English]

Allows you to choose the BIOS language version from the options. Configuration options: [English] [Français] [Deutsch] [简体中文] [繁體中文] [日本語] [Español] [Русский] [한국어]

System Date [Day xx/xx/xxxx]

Allows you to set the system date.

System Time [xx:xx:xx]

Allows you to set the system time.

Security

The Security menu items allow you to change the system security settings.



- If you have forgotten your BIOS password, erase the CMOS Real Time Clock (RTC) RAM to clear the BIOS password. See section **Jumpers** for information on how to erase the RTC RAM.
- The **Administrator** or **User Password** items on top of the screen show the default **Not Installed**. After you set a password, these items show **Installed**.

Administrator Password

If you have set an administrator password, we recommend that you enter the administrator password for accessing the system. Otherwise, you might be able to see or change only selected fields in the BIOS setup program.

To set an administrator password:

1. Select the **Administrator Password** item and press <Enter>.
2. From the **Create New Password** box, key in a password, then press <Enter>.
3. Confirm the password when prompted.

To change an administrator password:

1. Select the **Administrator Password** item and press <Enter>.
2. From the **Enter Current Password** box, key in the current password, then press <Enter>.
3. From the **Create New Password** box, key in a new password, then press <Enter>.
4. Confirm the password when prompted.

To clear the administrator password, follow the same steps as in changing an administrator password, but press <Enter> when prompted to create/confirm the password. After you clear the password, the **Administrator Password** item on top of the screen shows **Not Installed**.

User Password

If you have set a user password, you must enter the user password for accessing the system. The **User Password** item on top of the screen shows the default **Not Installed**. After you set a password, this item shows **Installed**.

To set a user password:

1. Select the **User Password** item and press <Enter>.
2. From the **Create New Password** box, key in a password, then press <Enter>.
3. Confirm the password when prompted.

To change a user password:

1. Select the **User Password** item and press <Enter>.
2. From the **Enter Current Password** box, key in the current password, then press <Enter>.
3. From the **Create New Password** box, key in a new password, then press <Enter>.
4. Confirm the password when prompted.

To clear the user password, follow the same steps as in changing a user password, but press <Enter> when prompted to create/confirm the password. After you clear the password, the **User Password** item on top of the screen shows **Not Installed**.

2.5 Ai Tweaker menu

The Ai Tweaker menu items allow you to configure overclocking-related items. Scroll down on the menu to display more items.



Be cautious when changing the settings of the Ai Tweaker menu items. Incorrect field values can cause the system to malfunction.



The configuration options for this section vary depending on the CPU and DIMM model you installed on the motherboard.



Current CPU Speed : xxxxMHz

Displays the current CPU speed.

Target CPU Speed : xxxxMHz

Displays the target CPU speed.

Current Memory Frequency : xxxxMHz

Displays the current memory frequency.

Current NB Frequency : xxxxMHz

Displays the current NB frequency.

Current HT Link Speed : xxxxMHz

Displays the current HT link speed.

Ai Overclock Tuner [Auto]

Allows you to select the CPU overclocking options to achieve the desired CPU internal frequency. Select any of these preset overclocking configuration options:

- [Auto] Loads the optimal settings for the system.
- [Manual] Allows you to individually set overclocking parameters.
- [D.O.C.P.] Allows you to select a DRAM O.C. profile, and the related parameters will be adjusted automatically.

CPU Ratio [Auto]

Allows user can manually adjust the maximum non-CPB mode CPU ratio. The value will be limit to CPU base or factory setting. Use the <+> and <-> keys to adjust the ratio. The valid value ranges vary according to your CPU model.

AMD Turbo CORE technology [Auto]

Allows you to enable or disable AMD Turbo CORE technology.

Configuration options: [Auto] [Disabled] [Enabled]

Memory Frequency [Auto]

Allows you to set the memory operating frequency.

Configuration options: [Auto] [DDR3-800MHz] [DDR3-1066MHz] [DDR3-1333MHz] [DDR3-1600MHz] [DDR3-1866MHz] [DDR3-2133MHz] [DDR3-2400MHz]



Selecting a very high memory frequency may cause the system to become unstable! If this happens, revert to the default setting.

CPU/NB Frequency [Auto]

Allows you to set the ratio between the NB (in CPU) Clock and the CPU Bus Frequency.

Configuration options: [Auto] [1400MHz] [1600MHz] [1800MHz] [2000MHz] [2200MHz] [2400MHz] [2600MHz] [2800MHz] [3000MHz] [3200MHz]

HT Link Speed [Auto]

Allows you to select the HyperTransport link speed.

Configuration options: [Auto] [800MHz] [1000MHz] [1200MHz] [1400MHz] [1600MHz] [1800MHz] [2000MHz] [2200MHz] [2400MHz]

CPU Spread Spectrum [Auto]

- [Auto] Automatic configuration.
- [Disabled] Enhances the BCLK overclocking ability.
- [Enabled] Sets to [Enabled] for EMI control.

PCIe Spread Spectrum [Auto]

- [Auto] Automatic configuration.
- [Disabled] Enhances the PCIe overclocking ability.
- [Enabled] Sets to [Enabled] for EMI control.

EPU Power Saving Mode [Disabled]

The ASUS EPU (Energy Processing Unit) sets the CPU in its minimum power consumption settings. Enable this item to set lower CPU core/cache voltage and achieve the best energy saving condition.

Configuration options: [Disabled] [Enabled]



The following item appears only when you set EPU Power Saving Mode to **[Enabled]**.

EPU Setting [Auto]

This item allows you to set power saving mode. Configuration options: [Auto] [Light Power Saving Mode] [Medium Power Saving Mode] [Max Power Saving Mode]

OC Tuner [CANCEL]

OC Tuner utility automatically overclocks the frequency and voltage of the CPU and DRAM. Press <Enter> to start auto tuning. It takes around five minutes, and the system will reboot for several times until auto tuning is completed.

Configuration options: [OK] [Cancel]



The configuration options for the following sub-items vary depending on the CPU/DIMMs you install on the motherboard.

DRAM Timing Control

The sub-items in this menu allow you to set the DRAM timing control features. Use the <+> and <-> keys to adjust the value. To restore the default setting, type [auto] using the keyboard and press <Enter>.



Changing the values in this menu may cause the system to become unstable! If this happens, revert to the default settings.

DRAM Driving Control

The sub-items in this menu allow you to set the DRAM driving control features. Use the <+> and <-> keys to adjust the value. To restore the default setting, type [auto] using the keyboard and press <Enter>.



Changing the values in this menu may cause the system to become unstable! If this happens, revert to the default settings.

DIGI+ Power Control

CPU Load-Line Calibration [Auto]

Load-line is defined by AMD VRM spec and affects CPU voltage. The CPU working voltage will decrease proportionally to CPU loading. Higher value gets a higher voltage and better overclocking performance, but increases the CPU and VRM thermal. This item allows you to enable or disable the CPU Load-Line Calibration function.

Configuration options: [Auto] [Regular] [Medium] [High] [Ultra High] [Extreme]

CPU/NB Load-Line Calibration [Auto]

This item allows you to enable or disable the CPU/NB Load-Line Calibration function.

Configuration options: [Auto] [Regular] [High] [Extreme]

CPU Current Capability [Auto]

This item provides a total power range for CPU overclocking. A higher value setting provides higher power consumption delivery and extends the overclocking frequency range simultaneously.

Configuration options: [Auto] [100%] [110%] [120%] [130%] [140%]



Configure higher values when overclocking or under a high CPU loading for extra power support.

CPU/NB Current Capability [Auto]

This item provides wider total power range for overclocking. A higher value brings a wider total power range and extends the overclocking frequency range simultaneously.

Configuration options: [Auto] [100%] [110%] [120%] [130%]

CPU Power Phase Control [Standard]

Phase number is the number of working VRM phase. Increasing phase number under heavy system loading to get more transient and better thermal performance. Reducing phase number under light system loading to increase VRM efficiency.

[Standard] Proceeds phase control depending on the CPU loading.

[Optimized] Loads the ASUS optimized phase tuning profile.

[Extreme] Proceeds the full phase mode.

[Manual Adjustment] Allows manual adjustment.

CPU Voltage Frequency [Auto]

Switching frequency will affect the VRM transient response and component thermal. Setting a higher frequency gets faster transient response.

[Auto] Allows you to enable or disable the Spread Spectrum item.

[Manual] Allows you to manually set the frequency with a 10k Hz interval.



The following item appears only when you set CPU Voltage Frequency to **[Auto]**.

VRM Spread Spectrum [Disabled]

This item allows you to enable the spread spectrum to enhance system stability.

Configuration options: [Disabled] [Enabled]



The following item appears only when you set CPU Voltage Frequency to **[Manual]**.

VRM Fixed Frequency Mode [200]

This item allows you to set a higher frequency for a quicker transient response speed. Use the <+> or <-> to adjust the value. The values range from 200 KHz to 400 KHz with an interval of 10 KHz.

CPU Power Duty Control [T.Probe]

[T.Probe] Maintains the VRM thermal balance.

[Extreme] Maintains the VRM current balance.

CPU Power Response Control [Auto]

Configuration options: [Auto] [Regular] [Medium] [Fast] [Ultra Fast]

CPU/NB Power Response Control [Auto]

Configuration options: [Auto] [Regular] [Medium] [Fast] [Ultra Fast]

CPU Power Thermal Control [130]

Higher temperature provides a wider CPU power thermal range and extends the overclocking tolerance to enlarge the overclocking potential.

Configuration options: [130] - [151]

CPU & NB Voltage [Offset Mode]

Allows you to set the CPU & NB Voltage Mode. Different sub-items appear according to the **CPU & NB Voltage Mode** item setting.

Configuration options: [Offset Mode] [Manual Mode]



The following items appear only when you set CPU & NB Voltage to **[Offset Mode]**.

Offset Mode Sign [+]

This item allows you to set the offset mode sign.

Configuration options: [+] [-]

CPU Offset Voltage [Auto]

This item allows you to set the CPU Offset voltage. Use the <+> or <-> to adjust the value. The values range from 0.006250V to 0.700000V with an interval of 0.06250V.

CPU/NB Offset Mode Sign [+]

This item allows you to set the offset mode sign.

Configuration options: [+] [-]

CPU/NB Offset Voltage [Auto]

This item allows you to set the CPU/NB Offset voltage. Use the <+> or <-> to adjust the value. The values range from 0.006250V to 0.700000V with an interval of 0.06250V.



The following items appear only when you set CPU & NB Voltage to **[Manual Mode]**.

CPU Manual Voltage [Auto]

This item allows you to set a fixed CPU voltage. Use the <+> or <-> to adjust the value. The values range from 0.006250V to 2.075000V with an interval of 0.06250V.

CPU/NB Manual Voltage [Auto]

This item allows you to set a fixed CPU/NB voltage. Use the <+> or <-> to adjust the value. The values range from 0.500000V to 1.900000V with an interval of 0.06250V.

CPU VDDA Voltage [Auto]

Allows you to set the CPU VDDA voltage. Use the <+> or <-> to adjust the value. The values range from 2.200000V to 2.800000V with a 0.006250V interval.

DRAM Voltage [Auto]

Allows you to set the DRAM voltage. Use the <+> or <-> to adjust the value. The values range from 1.200000V to 2.200000V with a 0.006250V interval.

NB Voltage [Auto]

Allows you to set the Northbridge voltage. Use the <+> or <-> to adjust the value. The values range from 1.100000V to 1.250000V with a 0.006250V interval.

NB HT Voltage [Auto]

Allows you to set the Northbridge HyperTransport voltage. Use the <+> or <-> to adjust the value. The values range from 1.200000V to 1.400000V with a 0.006250V interval.

2.6 Advanced menu

The Advanced menu items allow you to change the settings for the CPU and other system devices.



Be cautious when changing the settings of the Advanced menu items. Incorrect field values can cause the system to malfunction.

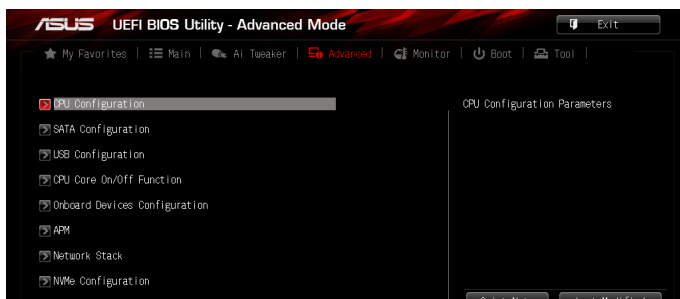

2.6.1 CPU Configuration

The items in this menu show the CPU-related information that the BIOS automatically detects.



The items shown in submenu may be different due to the CPU you installed.

Cool'n'Quiet [Always Enabled]

This item allows you to enable or disable the Cool 'n' Quiet function.

Configuration options: [Disabled by CPU] [Always Enabled] [Always Disabled]

C1E [Enabled]

This item allows your system to utilize the AMD specific ACPI states to save power consumption.

Configuration options: [Disabled] [Enabled]

SVM [Enabled]

[Disabled] Disables this function.

[Enabled] Enables the AMD Secure Virtual Machine mode.

Core C6 State [Enabled]

Enables or disables Core C6 state function.

Configuration options: [Disabled] [Enabled]

HPC Mode [Disabled]

Allows you to disable or enable High Performance Computing Mode.

Configuration options: [Disabled] [Enabled]

Apm Master Mode [Auto]

Enables or disables Application Power Management.

Configuration options: [Auto] [Disabled] [Enabled]

2.6.2 SATA Configuration

While entering Setup, the BIOS automatically detects the presence of SATA devices. The SATA Port items show **Not Present** if no SATA device is installed to the corresponding SATA port.

SB SATA Configuration

Allows you to set SATA options.

OnChip SATA Channel [Enabled]

Allows you to enable or disable serial ATA.

Configuration options: [Enabled] [Disabled]



The following items appear only when you set OnChip SATA Channel to **[Enabled]**.

SATA Port1 - Port4 [AHCI]

- [IDE] Set to [IDE] when you want to use the Serial ATA hard disk drives as Parallel ATA physical storage devices.
- [AHCI] Set to [AHCI] when you want the SATA hard disk drives to use the AHCI (Advanced Host Controller Interface). The AHCI allows the onboard storage driver to enable advanced Serial ATA features that increases storage performance on random workloads by allowing the drive to internally optimize the order of commands.
- [RAID] Set to [RAID] when you want to create a RAID configuration from the SATA hard disk drives.



The following item appears only when you set SATA Port1 - Port4 to **[AHCI]**.

SATA ESP on PORT1 ~ 4 [Disabled]

Configuration options: [Enabled] [Disabled]



The following item appears only when you set SATA Port1 - Port4 to **[RAID]**.

Board SATA RAID ROM [Legacy ROM]

This item allows you to select Board SATA RAID ROM.

Configuration options: [Disabled] [Legacy ROM] [UEFI DRIVER]

SATA Port5 - Port6 [AHCI]

Allows you to set the SATA port 5~6 mode.

Configuration options: [AHCI] [IDE] [RAID]



-
- When the **SATA Port1–Port 4** and the **SATA Port5–Port 6** items are set to [AHCI], the information of the SATA connectors 1–6 can be seen only under the OS environment or during POST.
 - The configuration options of SATA Port5 - Port6 will vary according to the configuration option of the SATA Port1 - Port4.
-



The following item appears only when you set SATA Port5 - Port6 to **[AHCI]**.

SATA ESP on PORT5 ~ 6 [Disabled]

Configuration options: [Enabled] [Disabled]

S.M.A.R.T. Status Check [Enabled]

- [Disabled] Disables the S.M.A.R.T feature.
- [Enabled] Enables the S.M.A.R.T feature.

2.6.3 USB Configuration

The items in this menu allow you to change the USB-related features.



The **USB Devices** item shows the auto-detected values. If no USB device is detected, the item shows None.

Legacy USB Support [Enabled]

- [Disabled] The USB devices can be used only for the BIOS setup program.
- [Enabled] Enables the support for USB devices on legacy operating systems (OS).
- [Auto] Allows the system to detect the presence of USB devices at startup. If detected, the USB controller legacy mode is enabled. If no USB device is detected, the legacy USB support is disabled.



The following item appears only when you set Legacy USB Support to **[Auto]** or **[Enabled]**.

Legacy USB3.0 Support [Enabled]

- [Disabled] Disables the function.
- [Enabled] Enables the support for USB 3.0 devices on legacy operating systems (OS).

EHCI Hand-off [Disabled]

- [Disabled] Disables the function.
- [Enabled] Enables the support for operating systems without an EHCI hand-off feature.

SB USB Configuration

Options for SB USB Configuration.

USB PORT 1 ~ 14 [Enabled]

Configuration options: [Disabled] [Enabled]

2.6.4 CPU Core On/Off Function

CPU Core Activation [Auto]

This item lets user turn off cores except core 1, user can turn off 2nd, 3rd, 4th, 5th, etc core manually. Configuration options: [Auto] [Manual]



The following items appear only when you set CPU Core Activation to **[Manual]**.

3rd & 4th Core [Enabled]

Configuration options: [Disabled] [Enabled]

5th & 6th Core [Enabled]

Configuration options: [Disabled] [Enabled]

7th & 8th Core [Enabled]

Configuration options: [Disabled] [Enabled]

2.6.5 Onboard Devices Configuration

Asmedia USB 3.1 Controller [Enabled]

[Disabled] Disables the controller.

[Enabled] Enables the rear USB 3.1 controller.

Asmedia USB 3.0 Controller [Enabled]

[Disabled] Disables the controller.

[Enabled] Enables the front USB 3.0 controller.

Asmedia USB 3.0 Battery Charging Support [Disabled]

[Disabled] Disables this function

[Enabled] Enables the Asmedia USB 3.0 battery charging function.

Intel LAN Controller [Enabled]

[Disabled] Disables the controller.

[Enabled] Enables the Intel LAN controller.



The following item appears only when you set Intel LAN Controller to **[Enabled]**.

Intel LAN PXE Option ROM [Disabled]

This item allows you to enable or disable the Rom Help of the Realtek LAN controller.

Configuration options: [Disabled] [Enabled]

Serial Port Configuration

The sub-items in this menu allow you to set the serial port configuration.

Serial Port [Enabled]

Allows you to enable or disable the serial port (COM).

Configuration options: [Disabled] [Enabled]



The following item appears only when you set Serial Port to **[Enabled]**.

Change Settings [IO=3F8h; IRQ=4]

This item appears only when you set the previous item to [Enabled] and allows you to select the Serial Port base address.

Configuration options: [IO=3F8h; IRQ=4] [IO=2F8h; IRQ=3] [IO=3E8h; IRQ=4]
[IO=2E8h; IRQ=3]

SB HD Azalia Configuration

HD Azalia Configuration

Allows you to change the HD Azalia configuration.

[Disabled] Disables the device.

[Enabled] Enables the High Definition Audio Azalia device.



The following items appear only when you set HD Audio Azalia Device to **[Enabled]**.

Azalia Front Panel [HD]

Allows you to set the Azalia front panel audio connector (AAFP) type to legacy AC'97 or high-definition audio depending on the audio standard that the front panel audio module supports.

[AC97] Sets the front panel audio connector (AAFP) mode to legacy AC'97

[HD] Sets the front panel audio connector (AAFP) mode to high definition audio.

SPDIF Out Type [SPDIF]

[SPDIF] Sets to [SPDIF] for SPDIF audio output.

[HDMI] Sets to [HDMI] for HDMI audio output.

2.6.6 APM

ErP Ready [Disabled]

Allows the BIOS to switch off some power at S5 to get the system ready for ErP requirement. When this item is set to [Enabled], all other PME options will be switched off.

Configuration options: [Disabled] [Enabled]

Restore AC Power Loss [Power Off]

[Power Off] The system goes into off state after an AC power loss.

[Power On] The system goes into on state after an AC power loss.

[Last State] The system goes into either off or on state, whatever the system state was before the AC power loss.

Power On By PME [Disabled]

[Disabled] Disables the PME to wake up by PCI/PCIE devices.

[Enabled] Allows you to turn on the system through a PCI/PCIE LAN or modem card. This feature requires an ATX power supply that provides at least 1A on the +5VSB lead.

Power On By Ring [Disabled]

[Disabled] Disables Ring to generate a wake event.

[Enabled] Enables Ring to generate a wake event.

Power On By RTC [Disabled]

[Disabled] Disables RTC to generate a wake event.

[Enabled] When set to [Enabled], the items RTC Alarm Date (Days) and Hour/Minute/Second will become user-configurable with set values.

2.6.7 Network Stack

Network Stack [Disabled]

This item allows user to disable or enable the UEFI network stack.

Configuration options: [Disabled] [Enabled]



The following item appears only when you set Network Stack to **[Enabled]**.

Ipv4 PXE Support [Enabled]

Configuration options: [Disabled] [Enabled]

Ipv6 PXE Support [Enabled]

Configuration options: [Disabled] [Enabled]

2.6.8 NVMe Configuration

You may view the NVMe controller and Drive information if an NVMe device is connected.

2.7 Monitor menu

The Monitor menu displays the system temperature/power status, and allows you to change the fan settings. Scroll down on the menu to display more items.

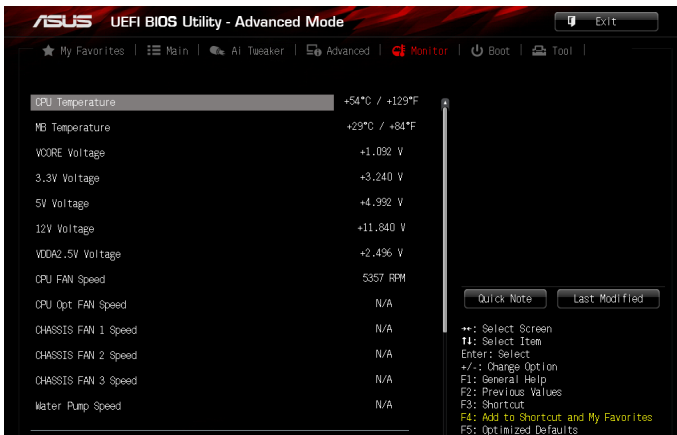

CPU Temperature / MB Temperature [xxx°C/xxx°F]

The onboard hardware monitor automatically detects and displays the CPU and motherboard temperatures. Select **Ignore** if you do not wish to display the detected temperatures.

VCORE Voltage, 3.3V Voltage, 5V Voltage, 12V Voltage, VDDA2.5V Voltage

The onboard hardware monitor automatically detects the voltage output through the onboard voltage regulators. Select **Ignore** if you do not want to detect this item.

CPU Fan Speed, CPU Opt Fan Speed, Chassis Fan 1-3 Speed, and Water Pump Speed [xxxx RPM] or [Ignore] / [N/A]

The onboard hardware monitor automatically detects and displays the CPU and chassis fan speeds in rotations per minute (RPM). If the fan is not connected to the motherboard, the field shows N/A. Select **Ignore** if you do not wish to display the detected speed.

CPU Q-Fan Control [PWM Mode]

- [Disabled] Disable the Q-Fan control.
- [PWM Mode] Enable the CPU Q-Fan control feature in PWM mode for 4-pin CPU fan.
- [DC Mode] Enable the CPU Q-Fan control feature in DC mode for 3-pin CPU fan.



The following items appear only when you set CPU Q-Fan Control to **[PWM Mode]** or **[DC Mode]**.

CPU_FAN Speed Low Limit [600 RPM]

This item allows you to disable or set the CPU fan warning speed.

Configuration options: [Ignore] [100 RPM] [200 RPM] [300 RPM] [400 RPM] [500 RPM] [600 RPM]

CPU Fan Profile [Standard]

This item allows you to set the appropriate performance level of the CPU fan.

- [Standard] Sets to [Standard] to make the CPU fan automatically adjust depending on the CPU temperature.
- [Silent] Sets to [Silent] to minimize the fan speed for quiet CPU fan operation.
- [Turbo] Sets to [Turbo] to achieve maximum CPU fan speed.
- [Manual] Sets to [Manual] to assign detailed fan speed control parameters.



The following items appear only when you set CPU Fan Profile to **[Manual]**.

CPU Upper Temperature [70]

Use the <+> and <-> keys to adjust the upper limit of the CPU temperature. The values range from 20°C to 75°C.

CPU Lower Temperature [20]

Displays the lower limit of the CPU temperature.

CPU Fan Max. Duty Cycle(%) [100]

Use the <+> and <-> keys to adjust the maximum CPU fan duty cycle. The values range from 20% to 100%. When the CPU temperature reaches the upper limit, the CPU fan will operate at the maximum duty cycle.

CPU Fan Min. Duty Cycle(%) [30]

Use the <+> and <-> keys to adjust the minimum CPU fan duty cycle. The values range from 0% to 100%. When the CPU temperature is under 40°C, the CPU fan will operate at the minimum duty cycle.

Chassis Q-Fan Control [Disabled]

[Disabled] Disables the Chassis Q-Fan control feature.

[Enabled] Enables the Chassis Q-Fan control feature.



The following items appear only when you set Chassis Q-Fan Control to **[Enabled]**.

Chassis Fan Speed Low Limit [600 RPM]

This item allows you to disable or set the chassis fan warning speed.

Configuration options: [Ignore] [100 RPM] [200 RPM] [300 RPM] [400 RPM] [500 RPM] [600 RPM]

Chassis Fan Profile [Standard]

This item allows you to set the appropriate performance level of the chassis fan.

[Standard] Sets to [Standard] to make the chassis fan automatically adjust depending on the chassis temperature.

[Silent] Sets to [Silent] to minimize the fan speed for quiet chassis fan operation.

[Turbo] Sets to [Turbo] to achieve maximum chassis fan speed.

[Manual] Sets to [Manual] to assign detailed fan speed control parameters.



The following items appear only when you set Chassis Fan Profile to **[Manual]**.

Chassis Upper Temperature [70]

Use the <+> and <-> keys to adjust the upper limit of the chassis temperature. The values range from 40°C to 90°C.

Chassis Lower Temperature [40]

Displays the lower limit of the chassis temperature.

Chassis Fan Max. Duty Cycle(%) [60]

Use the <+> and <-> keys to adjust the maximum chassis fan duty cycle. The values range from 60% to 100%. When the chassis temperature reaches the upper limit, the chassis fan will operate at the maximum duty cycle.

Chassis Fan Min. Duty Cycle(%) [60]

Use the <+> and <-> keys to adjust the minimum chassis fan duty cycle. The values range from 60% to 100%. When the chassis temperature is under 40°C, the chassis fan will operate at the minimum duty cycle.

Water Pump Control [Disabled]

- [Disabled] Disable the Water Pump control feature.
- [DC mode] Enable the Water Pump control in DC mode for 3-pin chassis fan.
- [PWM mode] Enable the Water Pump control in PWM mode for 4-pin chassis fan.



The following items appear only when you set the Water Pump Control to **[DC mode]** or **[PWM mode]**.

PUMP Fan Speed Low Limit [600 RPM]

This item allows you to disable or set the water pump warning speed.

Configuration options: [Ignore] [100 RPM] [200 RPM] [300 RPM] [400 RPM] [500 RPM] [600 RPM]

Water Pump Profile [Standard]

This item allows you to set the appropriate performance level of the chassis fan.

- [Standard] Sets to [Standard] to make the chassis fan automatically adjust depending on the chassis temperature.
- [Silent] Sets to [Silent] to minimize the fan speed for quiet chassis fan operation.
- [Turbo] Sets to [Turbo] to achieve maximum chassis fan speed.
- [Manual] Sets to [Manual] to assign detailed fan speed control parameters.



The following items appear only when you set **Water Pump Profile** to [Manual].

Water Pump Upper Temperature [70]

Use the <+> and <-> keys to adjust the upper limit of the chassis temperature. The values range from 40°C to 90°C.

Water Pump Lower Temperature [40]

Displays the lower limit of the chassis temperature.

Water Pump Max. Duty Cycle(%) [60]

Use the <+> and <-> keys to adjust the maximum chassis fan duty cycle. The values range from 60% to 100%. When the chassis temperature reaches the upper limit, the chassis fan will operate at the maximum duty cycle.

Water Pump Min. Duty Cycle(%) [60]

Use the <+> and <-> keys to adjust the minimum chassis fan duty cycle. The values range from 60% to 100%. When the chassis temperature is under 40°C, the chassis fan will operate at the minimum duty cycle.

2.8 Boot menu

The Boot menu items allow you to change the system boot options. Scroll down on the menu to display more items.

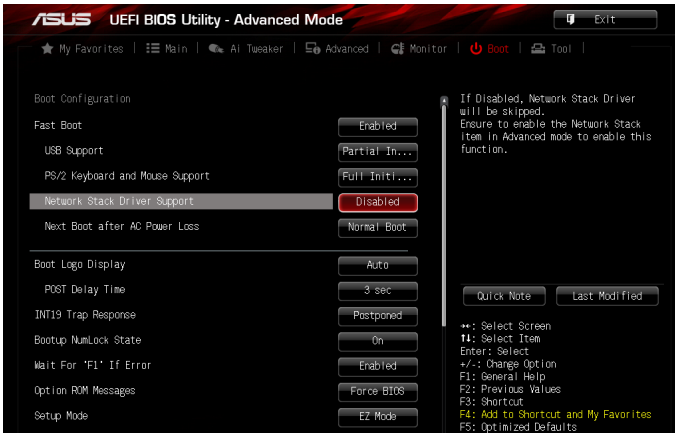

Fast Boot [Enabled]

[Disabled] Allows your system to go back to its normal boot speed.

[Enabled] Allows your system to accelerate the boot speed.



The following items appear only when you set the Fast Boot to **[Enabled]**.

USB Support [Partial Initialization]

[Disabled] All USB devices will not be available until OS boot up for a fastest POST time.

[Full Initialization] All USB devices will be available during POST. This process will extend the POST time.

[Partial Initialization] For a faster POST time, only the USB ports with keyboard and mouse connections will be detected.

PS/2 Keyboard and Mouse Support [Full Initialization]

Select any of these settings when PS/2 keyboard and mouse are installed. These settings only apply when Fast Boot is enabled.

- [Disabled] For the fastest POST time, all PS/2 devices will not be available until your computer enters the operating system.
- [Auto] For a faster POST time, PS/2 devices will only be available when the system boots up or rebooted when the PS/2 devices have not been reconnected or changed. If you disconnect or change PS/2 devices before restarting the system, PS/2 devices will not be available and BIOS setup program will not be accessible via PS/2 devices.
- [Full Initialization] For full system control, PS/2 devices will be available during POST at any circumstances. This process will extend POST time.

Network Stack Driver Support [Disabled]

- [Disabled] Select to skip the network stack driver from loading during POST.
- [Enabled] Select to load the network stack driver during POST.

Next Boot after AC Power Loss [Normal Boot]

- [Normal Boot] Returns to normal boot on the next boot after AC power loss.
- [Fast Boot] Accelerates the boot speed on the next boot after AC power loss.

Boot Logo Display [Auto]

- [Auto] Sets the boot logo to display during POST.
- [Full Screen] Sets the boot logo display in full screen during POST.
- [Disabled] Disables the boot logo display during POST.



The following item appears only when you set the Boot Logo Display to **[Auto]** and **[Full Screen]**.

Post Delay Time [3 sec]

This item allows you to select a desired additional POST waiting time to easily enter the BIOS Setup. You can only execute the POST delay time during normal boot. The values range from 0 to 10 seconds.



This feature only works when set under normal boot.



The following items appear only when you set the Boot Logo Display to **[Disabled]**.

Post Report [5 sec]

This item allows you to select a desired POST report waiting time.
Configuration options: [1 sec] - [10 sec] [Until Press ESC]

INT19 Trap Response [Postponed]

This item allows you to set the BIOS reaction on INT19 trapping by Option ROM.

[Immediate] Execute the trap right away.

[Postponed] Execute the trap during legacy boot.

Bootup NumLock State [On]

This item allows you to enable or disable power-on state of the NumLock.

Configuration options: [On] [Off]

Wait For 'F1' If Error [Enabled]

This item allows your system to wait for the <F1> key to be pressed when error occurs.

Configuration options: [Disabled] [Enabled]

Option ROM Messages [Force BIOS]

Configuration options: [Force BIOS] [Keep Current]

Setup Mode [EZ Mode]

[Advanced Mode] This item allows you to go to Advanced Mode of the BIOS after POST.

[EZ Mode] This item allows you to go to EZ Mode of the BIOS after POST.

CSM (Compatibility Support Module)

This item allows you to configure the CSM (Compatibility Support Module) items to fully support the various VGA, bootable devices and add-on devices for better compatibility.

Launch CSM [Enabled]

[Auto] The system automatically detects the bootable devices and the add-on devices.

[Enabled] For better compatibility, enable the CSM to fully support the non-UEFI driver add-on devices or the Windows® UEFI mode.

[Disabled] Disable the CSM to fully support the non-UEFI driver add-on devices or the Windows® UEFI mode.



The following items appear only when you set the Launch CSM to **[Enabled]**.

Boot Devices Control [UEFI and Legacy OPROM]

This item allows you to select the type of devices that you want to boot.

Configuration options: [UEFI and Legacy OPROM] [Legacy OPROM only] [UEFI only]

Boot from Network Devices [Legacy OpROM first]

This item allows you to select the type of network devices that you want to launch.

Configuration options: [Legacy OpROM first] [UEFI driver first] [Ignore]

Boot from Storage Devices [Legacy OpROM first]

This item allows you to select the type of storage devices that you want to launch.

Configuration options: [Both, Legacy OpROM first] [Both, UEFI first] [Legacy OpROM first] [UEFI driver first] [Ignore]

Boot from PCI-E/PCI Expansion Devices [Legacy OpROM first]

This item allows you to select the type of PCI-E/PCI expansion devices that you want to launch.

Configuration options: [Legacy OpROM first] [UEFI driver first]

Secure Boot

This item allows you to configure the Windows® Secure Boot settings and manage its keys to protect the system from unauthorized access and malwares during POST.

OS Type [Windows UEFI mode]

[Windows UEFI Mode] This item allows you to select your installed operating system. Execute the Microsoft® Secure Boot check. Only select this option when booting on Windows® UEFI mode or other Microsoft® Secure Boot compliant OS.

[Other OS] Get the optimized function when booting on Windows® non-UEFI mode. Microsoft® Secure Boot only supports Windows® UEFI mode.

Key Management

Clear Secure Boot keys

This item allows you to clear all default Secure Boot keys.

Save Secure Boot Keys

This item allows you to save the PK (Platform Keys) to a USB storage device.

PK Management

Delete PK

This item allows you to delete the PK from your system. Once the PK is deleted, all the system's Secure Boot keys will not be active.

Configuration options: [Yes] [No]

Load PK from File

This item allows you to load the downloaded PK from a USB storage device.



The PK file must be formatted as a UEFI variable structure with time-based authenticated variable.

KEK Management



Key-exchange Key (KEK) refers to Microsoft® Secure Boot Key-Enrollment Key (KEK).

Delete the KEK

Allows you to delete the KEK from your system.

Configuration options: [Yes] [No]

Load KEK from File

Allows you to load the downloaded KEK from a USB storage device.

Append KEK from File

Allows you to load the additional KEK from a storage device for an additional db and dbx loaded management.



The KEK file must be formatted as a UEFI variable structure with time-based authenticated variable.

DB Management

Delete the db

Allows you to delete the db file from your system.

Configuration options: [Yes] [No]

Load db from File

Allows you to load the downloaded db from a USB storage device.

Append db from File

Allows you to load the additional db from a storage device so that more images can be loaded securely.



The db file must be formatted as a UEFI variable structure with time-based authenticated variable.

DBX Management

Delete the dbx

Allows you to delete the dbx file from your system.

Load dbx from File

Allows you to load the downloaded dbx from a USB storage device.

Configuration options: [Yes] [No]

Append dbx from File

Allows you to load the additional dbx from a storage device so that more db's images cannot be loaded.



The dbx file must be formatted as a UEFI variable structure with time-based authenticated variable.

2.9 Tool menu

The Tools menu items allow you to configure options for special functions. Select an item then press <Enter> to display the submenu.

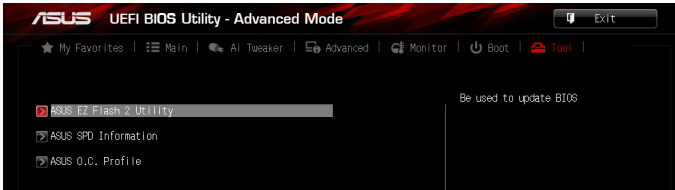

ASUS EZ Flash 2 Utility

Allows you to run ASUS EZ Flash 2. Press <Enter> to launch the ASUS EZ Flash 2 screen.



For more details, see section **ASUS EZ Flash 2**.

ASUS SPD Information

DIMM Slot # [Slot 2]

Displays the Serial Presence Detect (SPD) information of the DIMM module installed on the selected slot.

Configuration options: [Slot 1] [Slot 2] [Slot 3] [Slot 4]

ASUS O.C. Profile

This item allows you to store or load multiple BIOS settings.



The **Setup Profile Status** items show **Not Installed** if no profile is created.

Save to Profile

Allows you to save the current BIOS settings to the BIOS Flash, and create a profile. Key in a profile number from one to eight, press <Enter>, and then select **Yes**.

Load from Profile

Allows you to load the previous BIOS settings saved in the BIOS Flash. Key in the profile number that saved your CMOS settings, press <Enter>, and then select **Yes**.



-
- DO NOT shut down or reset the system while updating the BIOS to prevent the system boot failure!
 - We recommend that you update the BIOS file only coming from the same memory/CPU configuration and BIOS version.
-

2.10 Exit menu

The Exit menu items allow you to load the optimal default values for the BIOS items, and save or discard your changes to the BIOS items. You can access the EZ Mode from the Exit menu.

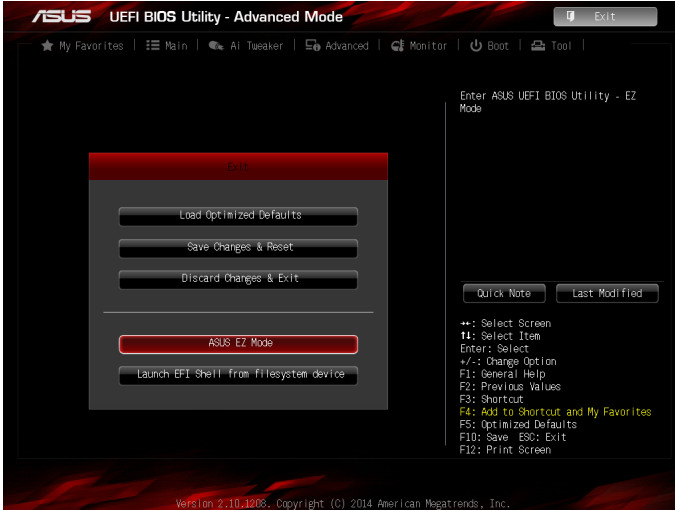

Load Optimized Defaults

This option allows you to load the default values for each of the parameters on the Setup menus. When you select this option or if you press <F5>, a confirmation window appears. Select Yes to load the default values.

Save Changes & Reset

Once you are finished making your selections, choose this option from the Exit menu to ensure the values you selected are saved. When you select this option or if you press <F10>, a confirmation window appears. Select Yes to save changes and exit.

Discard Changes & Exit

This option allows you to exit the Setup program without saving your changes. When you select this option or if you press <Esc>, a confirmation window appears. Select Yes to discard changes and exit.

ASUS EZ Mode

This option allows you to enter the EZ Mode screen.

Launch EFI Shell from filesystem device

This option allows you to attempt to launch the EFI Shell application (shellx64.efi) from one of the available devices that have a filesystem.

Appendices

Notices

Federal Communications Commission Statement

This device complies with Part 15 of the FCC Rules. Operation is subject to the following two conditions:

- This device may not cause harmful interference.
- This device must accept any interference received including interference that may cause undesired operation.

This equipment has been tested and found to comply with the limits for a Class B digital device, pursuant to Part 15 of the FCC Rules. These limits are designed to provide reasonable protection against harmful interference in a residential installation. This equipment generates, uses and can radiate radio frequency energy and, if not installed and used in accordance with manufacturer's instructions, may cause harmful interference to radio communications. However, there is no guarantee that interference will not occur in a particular installation. If this equipment does cause harmful interference to radio or television reception, which can be determined by turning the equipment off and on, the user is encouraged to try to correct the interference by one or more of the following measures:

- Reorient or relocate the receiving antenna.
- Increase the separation between the equipment and receiver.
- Connect the equipment to an outlet on a circuit different from that to which the receiver is connected.
- Consult the dealer or an experienced radio/TV technician for help.



The use of shielded cables for connection of the monitor to the graphics card is required to assure compliance with FCC regulations. Changes or modifications to this unit not expressly approved by the party responsible for compliance could void the user's authority to operate this equipment.

IC: Canadian Compliance Statement

Complies with the Canadian ICES-003 Class B specifications. This device complies with RSS 210 of Industry Canada. This Class B device meets all the requirements of the Canadian interference-causing equipment regulations.

This device complies with Industry Canada license exempt RSS standard(s). Operation is subject to the following two conditions: (1) this device may not cause interference, and (2) this device must accept any interference, including interference that may cause undesired operation of the device.

Cet appareil numérique de la Classe B est conforme à la norme NMB-003 du Canada. Cet appareil numérique de la Classe B respecte toutes les exigences du Règlement sur le matériel brouilleur du Canada.

Cet appareil est conforme aux normes CNR exemptes de licence d'Industrie Canada. Le fonctionnement est soumis aux deux conditions suivantes :

- (1) cet appareil ne doit pas provoquer d'interférences et
- (2) cet appareil doit accepter toute interférence, y compris celles susceptibles de provoquer un fonctionnement non souhaité de l'appareil.

Canadian Department of Communications Statement

This digital apparatus does not exceed the Class B limits for radio noise emissions from digital apparatus set out in the Radio Interference Regulations of the Canadian Department of Communications.

This class B digital apparatus complies with Canadian ICES-003.

VCCI: Japan Compliance Statement

Class B ITE

この装置は、クラスB情報技術装置です。この装置は、家庭環境で使用することを目的としていますが、この装置がラジオやテレビジョン受信機に近接して使用されると、受信障害を引き起こすことがあります。

取扱説明書に従って正しい取り扱いをして下さい。

VCCI-B

KC: Korea Warning Statement

B급 기기 (가정용 방송통신기자재)

이 기기는 가정용(B급) 전자파적합기기로서 주로 가정에서 사용하는 것을 목적으로 하며, 모든 지역에서 사용할 수 있습니다.

REACH

Complying with the REACH (Registration, Evaluation, Authorisation, and Restriction of Chemicals) regulatory framework, we published the chemical substances in our products at ASUS REACH website at <http://csr.asus.com/english/REACH.htm>.



DO NOT throw the motherboard in municipal waste. This product has been designed to enable proper reuse of parts and recycling. This symbol of the crossed out wheeled bin indicates that the product (electrical and electronic equipment) should not be placed in municipal waste. Check local regulations for disposal of electronic products.



DO NOT throw the mercury-containing button cell battery in municipal waste. This symbol of the crossed out wheeled bin indicates that the battery should not be placed in municipal waste.

ASUS Recycling/Takeback Services

ASUS recycling and takeback programs come from our commitment to the highest standards for protecting our environment. We believe in providing solutions for you to be able to responsibly recycle our products, batteries, other components as well as the packaging materials. Please go to <http://csr.asus.com/english/Takeback.htm> for detailed recycling information in different regions.

Google™ License Terms

Copyright© 2015 Google Inc. All Rights Reserved.

Licensed under the Apache License, Version 2.0 (the "License"); you may not use this file except in compliance with the License. You may obtain a copy of the License at:

<http://www.apache.org/licenses/LICENSE-2.0>

Unless required by applicable law or agreed to in writing, software distributed under the License is distributed on an "AS IS" BASIS, WITHOUT WARRANTIES OR CONDITIONS OF ANY KIND, either express or implied.

See the License for the specific language governing permissions and limitations under the License.

English AsusTek Inc. hereby declares that this device is in compliance with the essential requirements and other relevant provisions of CE Directives. Please see the CE Declaration of Conformity for more details.

Français AsusTek Inc. déclare par la présente que cet appareil est conforme aux critères essentiels et autres clauses pertinentes des directives européennes. Veuillez consulter la déclaration de conformité CE pour plus d'informations.

Deutsch AsusTek Inc. erklärt hiermit, dass dieses Gerät mit den wesentlichen Anforderungen und anderen relevanten Bestimmungen der CE-Richtlinien übereinstimmt. Weitere Einzelheiten entnehmen Sie bitte der CE-Konformitätserklärung.

Italiano AsusTek Inc. con la presente dichiara che questo dispositivo è conforme ai requisiti essenziali e alle altre disposizioni pertinenti alle direttive CE. Per maggiori informazioni fate riferimento alla dichiarazione di conformità CE.

Компанија ASUS заявљује, да је ово уређај у складу са основним захтеvима и другим релевантним одредбама CE директива. Молимо вас, погледajte CE Декларацију о усклађености за више детаља.

Български С настоящото AsusTek Inc. декларира, че това устройство е в съответствие със съществениите изисквания и другите приложими постановления на директивите CE. Вижте CE декларацията за съвместимост за повече информация.

Hrvatski AsusTek Inc. ovim izjavljuje da je ovaj uređaj sukladan s bitnim zahtjevima i ostalim odgovarajućim odredbama CE direktiva. Više pojedinosti potražite u CE izjavi o sukladnosti.

Čeština Společnost AsusTek Inc. tímto prohlašuje, že toto zařízení splňuje základní požadavky a další příslušná ustanovení směrnice CE. Další podrobnosti viz Prohlášení o shodě CE.

Dansk AsusTek Inc. Erklærer hermed, at denne enhed er i overensstemmelse med hovedkravene and andre relevante bestemmelser i CE-direktiverne. Du kan læse mere i CE-overensstemmelseserklæring.

Nederlands AsusTek Inc. verklaart hierbij dat dit apparaat compatibel is met de essentiële vereisten en andere relevante bepalingen van CE-richtlijnen. Raadpleeg de CE-verklaring van conformiteit voor meer details.

Esti Käesolevaga kinnitab AsusTek Inc., et see seade vastab CE direktiivide oluliste nõuetele ja teistele asjakohastele sätetele. Vt üksikasju CE vastavusdeklaratsioonist.

Suomi AsusTek Inc. vakuuttaa täten, että tämä laite on CE-direktiivien olennaisten vaatimusten ja muiden asiaan kuuluvien lisäysten mukainen. Katso lisätietoja CE-vaatimustenmukaisuusvakuutuksesta.

Ελληνικά Με το παρόν η AsusTek Inc. δηλώνει ότι αυτή η συσκευή συμμορφώνεται με τις θεμελιώδεις απαιτήσεις και άλλες σχετικές διατάξεις των Οδηγιών της ΕΕ. Για περισσότερες λεπτομέρειες ανατρέξτε στην Δήλωση Συμμόρφωσης ΕΕ.

Magyar Az AsusTek Inc. ezennel kijelenti, hogy a készülék megfelel a CE-irányelvek alapvető követelményeinek és ide vonatkozó egyéb rendelkezéseinek. További részletekért tekintse meg a CE-megfelelőségi nyilatkozatot.

Latviski Līdz ar šo AsusTek Inc. paziņo, ka šī ierīce atbilst būtiskajām prasībām un citiem saistošajiem nosacījumiem, kas norādīti CE direktīvā. Lai uzzinātu vairāk, skatiet CE Atbilstības deklarāciju.

Lietuvių Šiuo dokumentu bendrovė „AsusTek Inc.“ pareiškia, kad šis įrenginys atitinka pagrindinius CE direktyvų reikalavimus ir kitas susijusias nuostatas. Daugiau informacijos rasite CE atitikties deklaracijoje.

Norsk AsusTek Inc. erklærer herved at denne enheten er i samsvar med hovedsaklige krav og andre relevante forskrifter i CE-direktiver. Du finner mer informasjon i CE-samsvarserklæringen.

Polski Niniejszym AsusTek Inc. deklaruje, że to urządzenie jest zgodne z istotnymi wymaganiami oraz innymi powiązanymi zaleceniami Dyrektyw CE. W celu uzyskania szczegółów, sprawdź Deklarację zgodności CE.

Português A AsusTek Inc. declara que este dispositivo está em conformidade com os requisitos essenciais e outras disposições relevantes das Diretivas da CE. Para mais detalhes, consulte a Declaração de Conformidade CE.

Română Prin prezenta, AsusTek Inc. declară faptul că acest dispozitiv respectă cerințele esențiale și alte prevederi relevante ale directivelor CE. Pentru mai multe detalii, consultați declarația de conformitate CE.

Srpski AsusTek Inc. ovim izjavljuje da je ovaj uređaj u saglasnosti sa ključnim zahtjevima i drugim relevantnim odredbama CE Direktiva. Molimo vas, pogledajte CE Deklaraciju o usklađenosti za više detalja.

Slovensky Spoločnosť AsusTek Inc. týmto prehlasuje, že toto zariadenie vyhovuje príslušným požiadavkám a ďalším súvisiacim ustanoveniam smerníc ES. Viac podrobností si pozrite v prehlásení o zhode ES.

Slovenščina AsusTek Inc. tukaj izjavlja, da je ta naprava skladna temeljnimi zahtevami in drugimi relevantnimi določili direktiv CE. Za več informacij glejte izjavo CE o skladnosti.

Español Por la presente, AsusTek Inc. declara que este dispositivo cumple los requisitos básicos y otras disposiciones relevantes de las directivas de la CE. Consulte la Declaración de conformidad de la CE para obtener más detalles.

Svenska AsusTek Inc. förklarar härmed att denna enhet är i överensstämmelse med de grundläggande kraven och andra relevanta bestämmelser i CE-direktiverna. Se CE-försäkran om överensstämmelse för mer information.

Українська AsusTek Inc. заявляє, що цей пристрій відповідає основним вимогам відповідних Директив ЄС. Будь ласка, див. більше подробиць у Декларації відповідності нормам ЄС.

Türkçe AsusTek Inc., bu aygıtın temel gereksinimleri ve CE Yönergelerinin diğer ilgili koşullarına uyumlu olduğunu beyan eder. Daha fazla ayrıntı için lütfen CE Uygunluk Beyanına bakın.

Bosanski AsusTek Inc. ovim potvrđuje da je ovaj uređaj usklađen s osnovnim zahtjevima i drugim relevantnim propisima Direktiva EK. Za više informacija molimo pogledajte Deklaraciju o usklađenosti EK.

ASUS contact information

ASUSTeK COMPUTER INC.

Address 15 Li-Te Road, Peitou, Taipei, Taiwan 11259
Telephone +886-2-2894-3447
Fax +886-2-2890-7798
E-mail info@asus.com.tw
Web site www.asus.com.com/

Technical Support

Telephone +86-21-38429911
Fax +86-21-5866-8722, ext. 9101#
Online support <https://www.asus.com/tw/support/>

ASUS COMPUTER INTERNATIONAL (America)

Address 800 Corporate Way, Fremont, CA 94539, USA
Telephone +1-510-739-3777
Fax +1-510-608-4555
Web site <http://www.asus.com/us/>

Technical Support

Support fax +1-812-284-0883
Telephone +1-812-282-2787
Online support <http://www.service.asus.com/>

ASUS COMPUTER GmbH (Germany and Austria)

Address Harkort Str. 21-23, D-40880 Ratingen, Germany
Fax +49-2102-959911
Web site <http://www.asus.com/de>
Online contact <http://eu-rma.asus.com/sales>

Technical Support

Telephone +49-1805-010923
Support Fax +49-2102-9599-11
Online support <http://www.asus.com/de/support/>

