

**P8Z77 WS**

**Motherboard**

**ASUS®**

E7150

First Edition  
February 2012

**Copyright © 2012 ASUSTeK COMPUTER INC. All Rights Reserved.**

No part of this manual, including the products and software described in it, may be reproduced, transmitted, transcribed, stored in a retrieval system, or translated into any language in any form or by any means, except documentation kept by the purchaser for backup purposes, without the express written permission of ASUSTeK COMPUTER INC. ("ASUS").

Product warranty or service will not be extended if: (1) the product is repaired, modified or altered, unless such repair, modification of alteration is authorized in writing by ASUS; or (2) the serial number of the product is defaced or missing.

ASUS PROVIDES THIS MANUAL "AS IS" WITHOUT WARRANTY OF ANY KIND, EITHER EXPRESS OR IMPLIED, INCLUDING BUT NOT LIMITED TO THE IMPLIED WARRANTIES OR CONDITIONS OF MERCHANTABILITY OR FITNESS FOR A PARTICULAR PURPOSE. IN NO EVENT SHALL ASUS, ITS DIRECTORS, OFFICERS, EMPLOYEES OR AGENTS BE LIABLE FOR ANY INDIRECT, SPECIAL, INCIDENTAL, OR CONSEQUENTIAL DAMAGES (INCLUDING DAMAGES FOR LOSS OF PROFITS, LOSS OF BUSINESS, LOSS OF USE OR DATA, INTERRUPTION OF BUSINESS AND THE LIKE), EVEN IF ASUS HAS BEEN ADVISED OF THE POSSIBILITY OF SUCH DAMAGES ARISING FROM ANY DEFECT OR ERROR IN THIS MANUAL OR PRODUCT.

SPECIFICATIONS AND INFORMATION CONTAINED IN THIS MANUAL ARE FURNISHED FOR INFORMATIONAL USE ONLY, AND ARE SUBJECT TO CHANGE AT ANY TIME WITHOUT NOTICE, AND SHOULD NOT BE CONSTRUED AS A COMMITMENT BY ASUS. ASUS ASSUMES NO RESPONSIBILITY OR LIABILITY FOR ANY ERRORS OR INACCURACIES THAT MAY APPEAR IN THIS MANUAL, INCLUDING THE PRODUCTS AND SOFTWARE DESCRIBED IN IT.

Products and corporate names appearing in this manual may or may not be registered trademarks or copyrights of their respective companies, and are used only for identification or explanation and to the owners' benefit, without intent to infringe.

**Offer to Provide Source Code of Certain Software**

This product may contain copyrighted software that is licensed under the General Public License ("GPL") and under the Lesser General Public License Version ("LGPL"). The GPL and LGPL licensed code in this product is distributed without any warranty. Copies of these licenses are included in this product.

You may obtain the complete corresponding source code (as defined in the GPL) for the GPL Software, and/or the complete corresponding source code of the LGPL Software (with the complete machine-readable "work that uses the Library") for a period of three years after our last shipment of the product including the GPL Software and/or LGPL Software, which will be no earlier than December 1, 2011, either (1) for free by downloading it from <http://support.asus.com/download>;

or

(2) for the cost of reproduction and shipment, which is dependent on the preferred carrier and the location where you want to have it shipped to, by sending a request to:

ASUSTeK Computer Inc.  
Legal Compliance Dept.  
15 Li Te Rd.,  
Beitou, Taipei 112  
Taiwan

In your request please provide the name, model number and version, as stated in the About Box of the product for which you wish to obtain the corresponding source code and your contact details so that we can coordinate the terms and cost of shipment with you.

The source code will be distributed WITHOUT ANY WARRANTY and licensed under the same license as the corresponding binary/object code.

This offer is valid to anyone in receipt of this information.

ASUSTeK is eager to duly provide complete source code as required under various Free Open Source Software licenses. If however you encounter any problems in obtaining the full corresponding source code we would be much obliged if you give us a notification to the email address [gpl@asus.com](mailto:gpl@asus.com), stating the product and describing the problem (please do NOT send large attachments such as source code archives etc to this email address).

# Contents

Notices .....	vii
Safety information.....	viii
About this guide.....	ix
P8Z77 WS specifications summary.....	xi

## Chapter 1: Product introduction

1.1	Welcome! .....	1-1
1.2	Package contents.....	1-1
1.3	Special features.....	1-2
1.3.1	Product highlights.....	1-2
1.3.2	Dual Intelligent Processors 3.1 with New DIGI+ Power Control .	1-4
1.3.3	ASUS Exclusive Features.....	1-4
1.3.4	ASUS Quiet Thermal Solution.....	1-6
1.3.5	ASUS EZ DIY.....	1-6
1.3.6	ASUS Workstation exclusive features.....	1-7
1.3.7	Other special features.....	1-8

## Chapter 2: Hardware information

2.1	Before you proceed .....	2-1
2.2	Motherboard overview.....	2-2
2.2.1	Motherboard layout.....	2-2
2.2.2	Central Processing Unit (CPU).....	2-4
2.2.3	System memory.....	2-5
2.2.4	Expansion slots.....	2-7
2.2.5	Onboard switches.....	2-9
2.2.6	Onboard LEDs.....	2-14
2.2.7	Jumper.....	2-20
2.2.8	Internal connectors.....	2-21
2.3	Building your computer system.....	2-30
2.3.1	Additional tools and components to build a PC system.....	2-30
2.3.2	CPU installation.....	2-31
2.3.3	CPU heatsink and fan assembly installation.....	2-33
2.3.4	DIMM installation.....	2-35
2.3.5	Motherboard installation.....	2-36
2.3.6	ATX Power connection.....	2-38
2.3.7	SATA device connection.....	2-39
2.3.8	Front I/O Connector.....	2-40
2.3.9	Expansion Card installation.....	2-41
2.3.11	USB BIOS Flashback.....	2-42

# Contents

- 2.3.12 Rear panel connection ..... 2-43
- 2.3.13 Audio I/O connections ..... 2-45
- 2.4 Starting up for the first time ..... 2-47**
- 2.5 Turning off the computer ..... 2-47**

## **Chapter 3: BIOS setup**

- 3.1 Knowing BIOS ..... 3-1**
- 3.2 BIOS setup program ..... 3-1**
  - 3.2.1 EZ Mode ..... 3-2
  - 3.2.2 Advanced Mode ..... 3-3
- 3.3 Main menu ..... 3-5**
  - 3.3.1 System Language [English] ..... 3-5
  - 3.3.2 System Date [Day xx/xx/xxxx] ..... 3-5
  - 3.3.3 System Time [xx:xx:xx] ..... 3-5
- 3.4 Ai Tweaker menu ..... 3-8**
- 3.5 Advanced menu ..... 3-19**
  - 3.5.1 CPU Configuration ..... 3-20
  - 3.5.2 PCH Configuration ..... 3-22
  - 3.5.3 SATA Configuration ..... 3-24
  - 3.5.4 System Agent Configuration ..... 3-25
  - 3.5.5 USB Configuration ..... 3-26
  - 3.5.6 Onboard Devices Configuration ..... 3-27
  - 3.5.7 APM ..... 3-29
  - 3.5.8 Network Stack ..... 3-30
- 3.6 Monitor menu ..... 3-31**
- 3.7 Boot menu ..... 3-34**
- 3.8 Tools menu ..... 3-36**
  - 3.8.1 ASUS EZ Flash 2 Utility ..... 3-36
  - 3.8.2 ASUS O.C. Profile ..... 3-36
  - 3.8.3 ASUS SPD Information ..... 3-37
  - 3.8.4 ASUS Drive Xpert ..... 3-38
- 3.9 Exit menu ..... 3-39**
- 3.10 Updating BIOS ..... 3-40**
  - 3.10.1 ASUS Update utility ..... 3-40
  - 3.10.2 ASUS EZ Flash 2 utility ..... 3-43
  - 3.10.3 ASUS CrashFree BIOS 3 utility ..... 3-44
  - 3.10.4 ASUS BIOS Updater ..... 3-45

## **Chapter 4: Software support**

- 4.1 Installing an operating system ..... 4-1**

# Contents

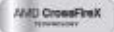
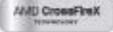
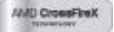
<b>4.2</b>	<b>Support DVD information</b> .....	<b>4-1</b>
4.2.1	Running the support DVD .....	4-1
4.2.2	Obtaining the software manuals.....	4-2
<b>4.3</b>	<b>Software information</b> .....	<b>4-3</b>
4.3.1	AI Suite II.....	4-3
4.3.2	TurboV EVO.....	4-4
4.3.3	DIGI+ Power Control .....	4-9
4.3.4	EPU.....	4-13
4.3.5	Probe II.....	4-14
4.3.6	FAN Xpert.....	4-15
4.3.7	Sensor Recorder .....	4-16
4.3.8	USB BIOS Flashback Wizard.....	4-17
4.3.9	USB 3.0 Boost.....	4-19
4.3.10	ASUS Update.....	4-20
4.3.11	ASUS SSD Caching.....	4-21
4.3.12	Network iControl.....	4-22
4.3.13	USB Charger+.....	4-26
4.3.14	MyLogo2 .....	4-28
4.3.15	Audio configurations.....	4-30
<b>4.4</b>	<b>RAID configurations</b> .....	<b>4-31</b>
4.4.1	RAID definitions .....	4-31
4.4.2	Installing Serial ATA hard disks .....	4-32
4.4.3	Setting the RAID item in BIOS .....	4-32
4.4.4	Intel® Rapid Storage Technology Option ROM utility .....	4-32
4.4.5	Marvell RAID utility .....	4-36
<b>4.5</b>	<b>Creating a RAID driver disk</b> .....	<b>4-42</b>
4.5.1	Creating a RAID driver disk without entering the OS.....	4-42
4.5.2	Creating a RAID driver disk in Windows®.....	4-42
4.5.3	Installing the RAID driver during Windows® OS installation .....	4-43
4.5.4	Using a USB floppy disk drive.....	4-44
 <b>Chapter 5: Multiple GPU technology support</b>		
<b>5.1</b>	<b>AMD® CrossFireX™</b>  <b>technology</b> .....	<b>5-1</b>
5.1.1	Requirements.....	5-1
5.1.2	Before you begin .....	5-1
5.1.3	Installing two CrossFireX™  graphics cards .....	5-2
5.1.4	Installing the device drivers.....	5-3
5.1.5	Enabling the AMD® CrossFireX™  technology.....	5-3
<b>5.2</b>	<b>NVIDIA® SLI™ technology</b> .....	<b>5-4</b>

# Contents

- 5.2.1 Requirements..... 5-4
- 5.2.2 Installing two SLI-ready graphics cards ..... 5-4
- 5.2.3 Installing three SLI-ready graphics cards..... 5-5
- 5.2.4 Installing four SLI-ready graphics cards..... 5-6
- 5.2.3 Installing the device drivers..... 5-7
- 5.2.4 Enabling the NVIDIA® SLI™ technology ..... 5-7
- 5.3 LucidLogix® Virtu™ solution..... 5-10**
  - 5.3.1 Hardware installAMD on ..... 5-10
  - 5.3.2 Software configuration ..... 5-11

# Notices

## Federal Communications Commission Statement

This device complies with Part 15 of the FCC Rules. Operation is subject to the following two conditions:

- This device may not cause harmful interference, and
- This device must accept any interference received including interference that may cause undesired operation.

This equipment has been tested and found to comply with the limits for a Class B digital device, pursuant to Part 15 of the FCC Rules. These limits are designed to provide reasonable protection against harmful interference in a residential installation. This equipment generates, uses and can radiate radio frequency energy and, if not installed and used in accordance with manufacturer's instructions, may cause harmful interference to radio communications. However, there is no guarantee that interference will not occur in a particular installation. If this equipment does cause harmful interference to radio or television reception, which can be determined by turning the equipment off and on, the user is encouraged to try to correct the interference by one or more of the following measures:

- Reorient or relocate the receiving antenna.
- Increase the separation between the equipment and receiver.
- Connect the equipment to an outlet on a circuit different from that to which the receiver is connected.
- Consult the dealer or an experienced radio/TV technician for help.



---

The use of shielded cables for connection of the monitor to the graphics card is required to assure compliance with FCC regulations. Changes or modifications to this unit not expressly approved by the party responsible for compliance could void the user's authority to operate this equipment.

---

## Canadian Department of Communications Statement

This digital apparatus does not exceed the Class B limits for radio noise emissions from digital apparatus set out in the Radio Interference Regulations of the Canadian Department of Communications.

This class B digital apparatus complies with Canadian ICES-003.

## REACH

Complying with the REACH (Registration, Evaluation, Authorisation, and Restriction of Chemicals) regulatory framework, we published the chemical substances in our products at ASUS REACH website at <http://csr.asus.com/english/REACH.htm>.



---

**DO NOT** throw the motherboard in municipal waste. This product has been designed to enable proper reuse of parts and recycling. This symbol of the crossed out wheeled bin indicates that the product (electrical and electronic equipment) should not be placed in municipal waste. Check local regulations for disposal of electronic products.

---



---

**DO NOT** throw the mercury-containing button cell battery in municipal waste. This symbol of the crossed out wheeled bin indicates that the battery should not be placed in municipal waste.

---

# Safety information

## Electrical safety

- To prevent electrical shock hazard, disconnect the power cable from the electrical outlet before relocating the system.
- When adding or removing devices to or from the system, ensure that the power cables for the devices are unplugged before the signal cables are connected. If possible, disconnect all power cables from the existing system before you add a device.
- Before connecting or removing signal cables from the motherboard, ensure that all power cables are unplugged.
- Seek professional assistance before using an adapter or extension cord. These devices could interrupt the grounding circuit.
- Ensure that your power supply is set to the correct voltage in your area. If you are not sure about the voltage of the electrical outlet you are using, contact your local power company.
- If the power supply is broken, do not try to fix it by yourself. Contact a qualified service technician or your retailer.

## Operation safety

- Before installing the motherboard and adding devices on it, carefully read all the manuals that came with the package.
- Before using the product, ensure all cables are correctly connected and the power cables are not damaged. If you detect any damage, contact your dealer immediately.
- To avoid short circuits, keep paper clips, screws, and staples away from connectors, slots, sockets and circuitry.
- Avoid dust, humidity, and temperature extremes. Do not place the product in any area where it may become wet.
- Place the product on a stable surface.
- If you encounter technical problems with the product, contact a qualified service technician or your retailer.



# About this guide

This user guide contains the information you need when installing and configuring the motherboard.

## How this guide is organized

This guide contains the following parts:

- **Chapter 1: Product introduction**  
This chapter describes the features of the motherboard and the new technology it supports.
- **Chapter 2: Hardware information**  
This chapter lists the hardware setup procedures that you have to perform when installing system components. It includes description of the switches, jumpers, and connectors on the motherboard.
- **Chapter 3: BIOS setup**  
This chapter tells how to change system settings through the BIOS Setup menus. Detailed descriptions of the BIOS parameters are also provided.
- **Chapter 4: Software support**  
This chapter describes the contents of the support DVD that comes with the motherboard package and the software.
- **Chapter 5: Multiple GPU technology support**  
This chapter describes how to install and configure multiple ATI® CrossFireX™ and NVIDIA® SLI™ graphics cards.

## Where to find more information

Refer to the following sources for additional information and for product and software updates.

1. **ASUS websites**  
The ASUS website provides updated information on ASUS hardware and software products. Refer to the ASUS contact information.
2. **Optional documentation**  
Your product package may include optional documentation, such as warranty flyers, that may have been added by your dealer. These documents are not part of the standard package.

## Conventions used in this guide

To ensure that you perform certain tasks properly, take note of the following symbols used throughout this manual.



**DANGER/WARNING:** Information to prevent injury to yourself when trying to complete a task.



**CAUTION:** Information to prevent damage to the components when trying to complete a task.



**IMPORTANT:** Instructions that you **MUST** follow to complete a task.



**NOTE:** Tips and additional information to help you complete a task.

## Typography

### **Bold text**

Indicates a menu or an item to select.

### *Italics*

Used to emphasize a word or a phrase.

### <Key>

Keys enclosed in the less-than and greater-than sign means that you must press the enclosed key.

Example: <Enter> means that you must press the Enter or Return key.

### <Key1> + <Key2> + <Key3>

If you must press two or more keys simultaneously, the key names are linked with a plus sign (+).

Example: <Ctrl> + <Alt> + <Del>

## P8Z77 WS specifications summary

<b>CPU</b>	<p>LGA1155 socket for 3<sup>rd</sup> Generation Intel® Core™ processor-based platform and 2<sup>nd</sup> Generation Core™ i7 / i5 / i3 / Pentium® / Celeron® processors</p> <p>Supports 22nm / 32nm CPU</p> <p>Supports Intel® Turbo Boost Technology 2.0*</p> <p>* The Intel® Turbo Boost technology 2.0 support depends on the CPU types.</p> <p>** Refer to <a href="http://www.asus.com">www.asus.com</a> for Intel® CPU support list.</p>
<b>Chipset</b>	Intel® Z77 Express Chipset
<b>Memory</b>	<p>4 x DIMMs, max. 32GB, DDR3 2600(O.C.)*/2400(O.C.)*/2200(O.C.)/1866(O.C.) /1600 / 1333 / 1066 MHz, non-ECC, un-buffered memory</p> <p>Dual-channel memory architecture</p> <p>Supports Intel® Extreme Memory Profile (XMP)</p> <p>*** Hyper DIMM support is subject to the physical characteristics of individual CPUs. Some hyper DIMMs only support one DIMM per channel. Please refer to Memory QVL for details.</p>
<b>Expansion slots</b>	<p>2 x PCI Express 2.0 x1 slots</p> <p>4 x PCI Express 3.0* / 2.0 x16 slot (single at x16 mode, dual at x16 /16, triple at x16/ x8/ x8, Quad at x8/ x8/ x8/ x8)</p> <p>* PCIe 3.0 speed is supported by Intel® 3<sup>rd</sup> generation processors.</p>
<b>VGA</b>	<p>Integrated Graphics Processor - Intel® HD Graphics support</p> <ul style="list-style-type: none"> <li>- Supports DVI-I Port with a max. resolution of 1920 x 1200 @60Hz</li> <li>- Supports Intel® InTru™ 3D/Quick Sync Video/Clear Video HD Technology/ Insider™</li> </ul>
<b>Multi-GPU support</b>	<p>Supports AMD® 4-Way CrossFireX™ Technology</p> <p>Supports NVIDIA® 4-Way SLI™ Technology</p> <p>Supports LucidLogix Virtu MVP Technology* *</p> <p>*LucidLogix Virtu MVP supports Windows 7 operating systems.</p>
<b>Storage</b>	<p>Intel® Z77 Express Chipset:</p> <ul style="list-style-type: none"> <li>- 2 x SATA 6.0 Gb/s ports with RAID 0, 1, 5, 10 support</li> <li>- 4 x SATA 3.0 Gb/s ports with RAID 0, 1, 5, 10 support</li> </ul> <p>* Supports on Intel® Smart Response Technology, Intel® Rapid Start Technology, Intel® Smart ConnectTechnology</p> <p>Marvell® 9128 SATA controllers:</p> <ul style="list-style-type: none"> <li>- 2 x SATA 6Gb/s ports with RAID 0,1 support</li> </ul> <p>ASMedia® SATA 6Gb/s controller**</p> <ul style="list-style-type: none"> <li>- 2 x eSATA 6Gb/s ports with port multiplier support</li> </ul> <p>*Supports on Intel® Core™ processor family with Windows 7 operating systems.</p> <p>**These SATA ports are for data hard drivers only. ATAPI devices are not supported.</p>
<b>LAN</b>	2*Intel® 82574L Gigabit LAN controller
<b>Audio</b>	<p>Realtek® ALC898 8-channel High Definition Audio CODEC</p> <ul style="list-style-type: none"> <li>- Absolute Pitch 192khz/24bit true BD lossless sound</li> <li>- BD audio layer content protection</li> <li>- DTS UltraPC II</li> <li>- DTS Connect</li> <li>- Supports Jack-Detection, Multi-streaming and Front Panel Jack-Retasking</li> <li>- Optical S/PDIF out ports at back I/O</li> </ul>

(continued on the next page)

# P8Z77 WS specifications summary

<b>USB</b>	<p><b>2 x ASMedia USB 3.0 controllers-supports ASUS USB 3.0 Boost UASP Mode.</b></p> <ul style="list-style-type: none"><li>- 2 x USB 3.0/2.0 ports at back panel (blue)</li></ul> <p><b>Intel® Z77 Express Chipset - supports ASUS USB 3.0 Boost UASP Turbo Mode*</b></p> <ul style="list-style-type: none"><li>- 2 x USB 3.0/2.0 ports at mid-board for front panel support</li><li>- 2 x USB 3.0/2.0 ports at back panel (blue)</li></ul> <p><b>Intel® Z77 Express Chipset</b></p> <ul style="list-style-type: none"><li>- 9 x USB 2.0/1.1 ports (5 ports at mid-board, 4 ports at back panel)</li></ul> <p>*The USB 3.0 ports only support Windows® 7 or later versions. UASP standard only supports Windows® 8.</p>
<b>ASUS Unique Features</b>	<p><b>SMART DIGI+</b></p> <ul style="list-style-type: none"><li>- Smart DIGI+ Key-quickly delivers higher VRM frequency, voltage, and current for superior CPU/iGPU/DRAM/ overclocking performance with one switch.</li><li>- Smart CPU Power Level (VRD 12.5 Ready)-provides the best digital power saving conditions.</li></ul> <p><b>CPU Power</b></p> <ul style="list-style-type: none"><li>- Industry leading digital 20-phase power design (16-phase for CPU, 4-phase or iGPU)</li><li>- ASUS CPU power utility</li></ul> <p><b>DRAM Power</b></p> <ul style="list-style-type: none"><li>- Industry leading Digital 2-phase DRAM power design</li><li>- ASUS DRAM power utility</li></ul> <p><b>ASUS TPU</b></p> <ul style="list-style-type: none"><li>- Auto Tuning, TurboV, TPU switch</li></ul> <p><b>ASUS EPU</b></p> <ul style="list-style-type: none"><li>- EPU Utility</li><li>- EPU Switch</li></ul> <p><b>ASUS Exclusive Features</b></p> <ul style="list-style-type: none"><li>- ASUS SSD Caching</li><li>- Network iControl featuring instant network bandwidth domination for top network program in use</li><li>- USB 3.0 Boost featuring the latest USB 3.0 UASP standard</li><li>- USB Charger+ featuring quick-charging function for all smart devices</li><li>- AI Charger+</li><li>- Disk Unlocker featuring 3TB+ HDD support</li><li>- AI Suite II</li><li>- Anti Surge</li><li>- MemOK!</li></ul> <p><b>ASUS Quiet Thermal Solution:</b></p> <ul style="list-style-type: none"><li>- ASUS Fan Xpert 2 featuring Fan Auto Tuning function for optimized speed control</li><li>- ASUS Fanless Design: Heat-pipe solution</li></ul> <p><b>ASUS EZ DIY:</b></p> <ul style="list-style-type: none"><li>- ASUS USB BIOS Flashback with USB BIOS Flashback Wizard for EZ BIOS download scheduling</li><li>- ASUS UEFI BIOS EZ Mode featuring friendly graphics user interface</li><li>- ASUS O.C. Tuner</li></ul>

(continued on the next page)

# P8Z77 WS specifications summary

<b>ASUS Exclusive Features</b>	<ul style="list-style-type: none"> <li>- ASUS CrashFree BIOS 3</li> <li>- ASUS EZ Flash 2</li> </ul> <p><b>ASUS Q-Design:</b></p> <ul style="list-style-type: none"> <li>- ASUS Q-code</li> <li>- ASUS Q-Shield</li> <li>- ASUS Q-LED (CPU, DRAM, VGA, Boot Device LED)</li> <li>- ASUS Q-DIMM</li> <li>- ASUS Q-Connector</li> </ul>
<b>Workstation Unique Features</b>	<ul style="list-style-type: none"> <li>- 4PCIe x 16 slots</li> <li>- Quick Gate: 1 vertical USB 2.0 on board</li> <li>- ASUS SASSaby series Cards support</li> <li>- ASUS WS Diag. LED</li> <li>- WS 3-color LED</li> </ul>
<b>Back Panel I/O Ports</b>	<ul style="list-style-type: none"> <li>4 x USB 3.0/2.0 ports (blue, 1 supports USB BIOS Flashback)</li> <li>4 x USB 2.0/1.1 ports</li> <li>1 x USB BIOS Flashback button</li> <li>1 x PS/2 KB/MS port</li> <li>1 x DVI-I port</li> <li>2 x eSATA ports</li> <li>2 x LAN (RJ-45) port (2 x Intel® LAN)</li> <li>1 x Optical S/PDIF Out port</li> <li>8-channel Audio I/O</li> </ul>
<b>Internal I/O connectors</b>	<ul style="list-style-type: none"> <li>1 x USB 3.0/2.0 connector supports additional 2 USB ports (19-pin)</li> <li>2 x USB 2.0/1.1 connectors support additional 4 USB ports</li> <li>1 x USB 2.0/1.1 type A vertical ports</li> <li>4 x SATA 6.0 Gb/s connectors (2 x gray; 2 x navy blue)</li> <li>4 x SATA 3.0 Gb/s connectors (blue)</li> <li>1 x CPU Fan connector (4-pin)</li> <li>1 x CPU Opt Fan connectors (4-pin)</li> <li>4 x Chassis Fan connectors (4-pin)</li> <li>1 x Front panel audio connector (AAFP)</li> <li>1 x S/PDIF out header</li> <li>24-pin EATX Power connector</li> <li>8-pin EATX 12V Power connector</li> <li>19-pin TPM header</li> <li>1 x MemOK! button</li> <li>1 x EPU Switch</li> <li>1 x TPU Switch</li> <li>1 x Power-on Switch</li> <li>1 x Reset button</li> </ul>
<b>BIOS features</b>	<p>64 Mb Flash ROM, UEFI AMI BIOS, PnP, DMI2.0, WfM2.0, SM BIOS 2.5, ACPI 2.0a, Multi-language BIOS, ASUS EZ Flash 2, ASUS CrashFree BIOS 3, F12 PrintScreen, F3 Shortcut Function and ASUS DRAM SPD (Serial Presence Detect) memory information</p>
<b>Manageability</b>	<p>WfM 2.0, DMI 2.0, WOL by PME, PXE</p>

(continued on the next page)

## P8Z77 WS specifications summary

<b>Accessories</b>	4 x Serial ATA 6.0Gb/s cables 2 x Serial ATA 3.0Gb/s cables ASUS 3-Way SLI bridge connector ASUS SLI bridge connector I/O Shield User Manual
<b>Support DVD contents</b>	Drivers ASUS Utilities ASUS Update Anti-virus software (OEM version)
<b>Form factor</b>	ATX Form Factor, 12"x 9.6" (30.5cm x 24.4cm)

\*Specifications are subject to change without notice.

# Chapter 1

## 1.1 Welcome!







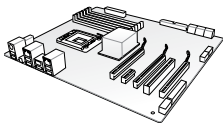

Thank you for buying an ASUS® P8Z77 WS motherboard!

The motherboard delivers a host of new features and latest technologies, making it another standout in the long line of ASUS quality motherboards!

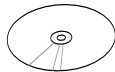
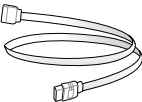
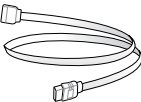
Before you start installing the motherboard, and hardware devices on it, check the items in your package with the list below.

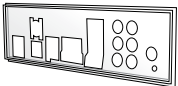
## 1.2 Package contents

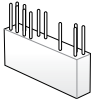
Check your motherboard package for the following items.

		
<b>ASUS P8Z77 WS motherboard</b>	<b>User manual</b>	<b>Support DVD</b>
		
<b>4 x Serial ATA 6.0 Gb/s cables</b>	<b>2 x Serial ATA 3.0 Gb/s cables</b>	<b>1 x ASUS SLI™ bridge connector</b>
		
<b>1 x ASUS Q-Shield</b>	<b>1 x 4-way SLI bridge</b>	<b>1 x 2-in-1 ASUS Q-Connector kit</b>
		
<b>1 x 3-way SLI bridge</b>		



- If any of the above items is damaged or missing, contact your retailer.
- The illustrated items above are for reference only. Actual product specifications may vary with different models.

## 1.3 Special features

### 1.3.1 Product highlights

#### **LGA1155 socket for Intel® Second/Third Generation Core™ i7 / Core™ i5 / Core™ i3 / Pentium® / Celeron® Processors**

This motherboard supports the Intel® 3rd/2nd generation Core™ i7/i5/i3/Pentium®/Celeron® processors in the LGA1155 package, with iGPU, memory, and PCI Express controllers integrated to support onboard graphics out with dedicated chipsets, 2-channel (4 DIMMs) DDR3 memory, and 16 PCI Express 3.0/2.0 lanes. This provides great graphics performance. Intel® 3rd/2nd generation Core™ i7/i5/i3/Pentium®/Celeron® processors are among the most powerful and energy efficient CPUs in the world.

#### **Intel® Z77 Express Chipset**

The Intel® Z77 Express Chipset is a single-chipset designed to support the 1155 socket Intel® 3rd/2nd generation Core™ i7/i5/i3/Pentium®/Celeron® processors. It provides improved performance by utilizing serial point-to-point links, allowing increased bandwidth and stability. Additionally, Z77 chipset provides 4 USB 3.0 ports for 10 times faster data retrieval speed. Moreover, Intel® Z77 Express Chipset can also enable iGPU function, letting users enjoy the latest Intel® integrated graphic performance.

#### **PCI Express® 3.0**

PCI Express® 3.0 (PCIe 3.0) is the latest PCI Express bus standard with improved encoding schemes that provide twice the performance of the current PCIe 2.0. The total bandwidth for a x16 link reaches a maximum of 32Gb/s, double the 16Gb/s of PCIe 2.0 (in x16 mode). As such, PCIe 3.0 provides users an unprecedented data speeds, combined with the convenience and seamless transition offered by complete backward compatibility with PCIe 1.0 and PCIe 2.0 devices. PCIe 3.0 will become a must-have feature for users who wish to improve and optimize graphic performance, as well as have the latest technology available to them.

\* PCI 3.0 speed is supported by Intel® 3rd generation Core™ processors.

#### **Dual-Channel DDR3 2400(O.C.) / 2200(O.C.) / 2133(O.C.) / 1866(O.C.) / 1600 / 1333 / 1066 MHz Support**

The motherboard supports DDR3 memory that features data transfer rates of DDR3 2600(O.C.) / 2400(O.C.) / 2200(O.C.) / 2133(O.C.) / 1866(O.C.) / 1600 / 1333 / 1066 MHz to meet the higher bandwidth requirements of the latest 3D graphics, multimedia, and Internet applications. The dual-channel DDR3 architecture enlarges the bandwidth of your system memory to boost system performance.

\* Due to Intel 2nd generation processor's behavior, DDR3 2200 and above, 2000/1800 MHz memory modules run at DDR3 2133/1866/1600 MHz frequency as default.

#### **Quad-GPU SLI™ and Quad-GPU CrossFireX™ Support**

##### **Flexible Multi-GPU Solutions, Your Weapon of Choice!**

P8Z77 WS brings you the multi-GPU choice of either SLI™ or CrossFireX. The motherboard features the most powerful Intel® Z77 platform to optimize PCIe allocation in multiple GPU configurations. Expect a brand-new gaming style you've never experienced before!



## Intel® Smart Response Technology

### SSD Speed with HDD Capacity

Intel® Smart Response Technology boosts overall system performance. It uses an installed fast SSD (min 18.6GB available capacity required) as a cache for frequently accessed data. Key benefits include reduced load and wait times, and lower power consumption through the elimination of unnecessary hard drive spin. This technology combines SSD performance with hard drive capacity, operating up to 6X faster than a hard drive-only system, and an important part of Green ASUS eco-friendly computing.

\* Intel® Smart Response Technology is supported by 2nd/3rd generation Intel® Core™ processor family on Windows® 7™ operating systems.

\*\* Operating systems must be installed on the HDD to launch Intel® Smart Response Technology. The capacity of the SSD is reserved for caching function.

## Intel® Smart Connect Technology

Your computer can receive web updates with fresh content for selected applications, even when the system is in sleep mode. This means less time waiting for applications to update, and sync with the cloud, leading to a more efficient computing experience.

## Intel® Rapid Start Technology

Allows your computer to quickly resume from a low-power hibernate state in seconds. Saving system memory to the designed SSD, it provides your computer a faster wake-up response time, while still keeping the energy use low.

## Complete USB 3.0 Integration

ASUS facilitates the strategic USB 3.0 accessibility for both the front and rear panel – 8 USB 3.0 ports in total. Experience the latest plug & play connectivity at speeds up to 10 times faster than USB 2.0. The P8Z77 WS affords greater convenience to high speed connectivity.

## Extra SATA 6.0 Gb/s Support

The Intel® Z77 Express Chipset natively supports the next-generation Serial ATA (SATA) interface, delivering up to 6.0 Gb/s data transfer. ASUS provides extra SATA 6.0 Gb/s ports with enhanced scalability, faster data retrieval, and double the bandwidth of current bus systems.

## Dual Gigabit LAN support

The P8Z77 WS features the dual Gigabit LAN design which complies with 802.3az Energy Efficient Ethernet (EEE) standard, and allows a PC to serve as a network gateway for managing traffic between two separate networks. Moreover, this motherboard also implements one Intel® Gigabit LAN controller which reduces power consumption during normal operation, and enhances faster transfer speed through a dual interconnection between the Integrated LAN controller and physical layer (PHY).

### 1.3.2 Dual Intelligent Processors 3.1 with New DIGI+ Power Control

The world's first Dual Intelligent Processors from ASUS pioneered twin onboard chips - TPU (TurboV Processing Unit) and EPU (Energy Processing Unit). Dual Intelligent Processors 3 builds on that foundation with new SMART DIGI+ power control, which includes multiple digital voltage controllers, allowing ultra-precise tuning for the CPU, iGPU and DRAM. It's upgraded with one-click extreme performance optimization and selectable CPU wattage levels, offering easier power control and better power savings with the user-friendly AI Suite II utility.

#### Smart DIGI+ Technology

Get incredible performance increases with TPU and the all-new SMART DIGI+.

##### Up to 85% CPU O.C. Performance Boost

Always at the forefront of digital power design, ASUS propels you into the future standard of power management by SMART DIGI+ Technology, which works with the TPU (TurboV Processing Unit) to give an exceptional increase in CPU overclocking performance. When combined, you can adjust CPU ratios manually in the TPU and enable the all new SMART DIGI+ Key by a single click to see an extreme boost in TPU frequency up to 85%.

##### CPU Power Wattage cut in half!

SMART DIGI+ Technology also includes the Smart CPU Power Level profile, which reduces CPU power consumption to a specific indicated wattage with a single click, creating a cooler and quieter PC. With the support for the next generation Intel® VRD 12.5 power design, ASUS once again leaps to the future of innovation.

#### TPU

Unleash your performance with ASUS' simple onboard switch or AI Suite II utility. The TPU chip offers precise voltage control and advanced monitoring through Auto Tuning and TurboV functions. Auto tuning offers a user friendly way to automatically optimize the system for fast, yet stable clock speeds, while TurboV enables unlimited freedom to adjust CPU frequencies and ratios for optimized performance in diverse situations.

#### EPU

Tap into the world's first real-time PC power saving chip through a simple onboard switch or AI Suite II utility. Get total system-wide energy optimization by automatically detecting current PC loadings and intelligently moderating power consumption. This also reduces fan noise and extends component longevity.

### 1.3.3 ASUS Exclusive Features

#### GPU Boost

GPU Boost accelerates the integrated GPU for extreme graphics performance. The user-friendly interface facilitates flexible frequency adjustments. It easily delivers stable system-level upgrades for every use.

## USB 3.0 Boost

New ASUS USB 3.0 Boost technology supports UASP (USB Attached SCSI Protocol), the latest USB 3.0 standard. With USB 3.0 Boost technology, a USB device's transmission speed is significantly increased up to 170%, adding to an already impressive fast USB 3.0 transfer speed. ASUS software automatically accelerates data speeds for compatible USB 3.0 peripherals without the need for any user interaction.

## USB Charger+

With a dedicated onboard controller, quick-charge all your smart devices such as iProducts, smartphones, tablets, and more, all up to 3x faster, even when the PC is powered off, in sleep, or hibernation modes.

## ASUS SSD Caching

SSD Caching from ASUS is easier than ever. At 3X faster, this feature boosts system performance by using an installed SSD with no capacity limitations as a cache for frequently accessed data. Harness a combination of SSD-like performance and response, and hard drive capacity with just one click, no rebooting needed, and instant activation for complete ease of use, and even prevent data loss with included backup functionality.

## USB BIOS Flashback

A truly revolutionary hardware-based BIOS update solution. USB BIOS Flashback offers the most convenient way to update the BIOS! It allows users to update new UEFI BIOS versions even without hardware such as a CPU or a DRAM installed into the motherboard. Just plug in a USB flash drive containing the BIOS file, and press the BIOS Flashback button for 3 seconds with the power supply connected. The UEFI BIOS then automatically updates without requiring further interaction. With its new complementary Windows® application, users can regularly check for UEFI BIOS updates, and download the latest BIOS automatically. Hassle-free updating for the ultimate convenience!

## Network iControl

With a single-click on/off button, the application currently in use has its data and network bandwidth prioritized over other programs. Moreover, you can prioritize your favorite software easily by configuring profiles through the intuitive user interface. Within the profile, the programs can be pre-scheduled to run in a specific time period to avoid network congestion. and long-waits on downloads. Auto PPPoE network connection gives a one-step setup. Overall, it's an intuitive network bandwidth control center.

## AI Suite II

With its user-friendly interface, ASUS AI Suite II consolidates all the exclusive ASUS features into one simple to use software package. It allows you to supervise overclocking, energy management, fan speed control, voltage and sensor readings, and even interact with mobile devices via Wi-Fi. This all-in-one software offers diverse and ease to use functions, with no need to switch back and forth between different utilities.

## MemOK!

### Any Memory is A-OK!

MemOK! quickly ensures memory boot compatibility. This remarkable memory rescue tool requires a mere push of a button to patch memory issues. MemOK! determines fail-safe settings and dramatically improves your system boot success. Get your system up and running in no time!

## 1.3.4 ASUS Quiet Thermal Solution

### ASUS Fan Xpert 2 - featuring Fan Auto Tuning mode for the Ultimate Cool and Quiet

Hardware-level ASUS Fan Xpert 2 provides the most customizable settings for an even cooler and quieter computing environment. Upgraded with the Fan Auto Tuning mode, it enables tailored fan speed settings for each CPU and chassis fan, with exclusive automatic fan speed detection, which scans each fan to run at specific settings based on different criteria, achieving the best balance of cooling performance and low noise. Fan Xpert 2 also includes an RPM Fixed Mode for users who wish to reduce noise levels to near 0dB with highly specific fan speed control. It reacts to system loads for greater control.

## 1.3.5 ASUS EZ DIY

### ASUS UEFI BIOS (EZ Mode)

#### Flexible and Easy BIOS Interface

Media-renowned UEFI BIOS offers the first mouse-controlled graphical BIOS designed with selectable modes and native support for hard drives over 2.2 TB. Users can also drag and drop boot priorities with the exclusive EZ Mode, while Advanced Mode offers intricate settings.

#### New upgrade! Quick and easy information for enhanced system control

- F12 BIOS snapshot hotkey
- F3 Shortcut for most accessed information
- ASUS DRAM SPD (Serial Presence Detect) information detecting faulty DIMMs, and helping with difficult POST situations.

## ASUS Q-Design

### DIY Quickly, DIY Easily!

ASUS Q-Design enhances your DIY experience. All of Q-LED, Q-Code, Q-Slot, and Q-DIMM design speed up and simplify the DIY process!

## ASUS Q-Shield

### Easy and Comfortable Installations

The specially designed ASUS Q-Shield does without the usual "fingers" - making it convenient and easy to install. With better electric conductivity, it ideally protects your motherboard against static electricity and shields it against Electronic Magnetic Interference (EMI).

## ASUS Q-Connector

### Make Connection Quick and Accurate!

The ASUS Q-Connector allows you to connect or disconnect the chassis front panel cables in one easy step with one complete module. This unique adapter eliminates the trouble of plugging in one cable at a time, making the connection quick and accurate.

## ASUS EZ-Flash 2

ASUS EZ Flash 2 is a user-friendly utility that allows you to update the BIOS without using a bootable floppy disk or an OS-based utility.

### 1.3.6 ASUS Workstation exclusive features

#### 4-way SLI

Native third generation PCI-Express x16™ 4-way CrossFireX™ and Geforce SLI™ offers the fastest and most reliable graphics performance ever. It's ideal for professional use in mechanical, architectural, interior design, aeronautics, audio and video design applications. Additionally, this ample graphics power can easily run even the most demanding PC games in full detail for enhanced entertainment.

#### Dual Intel® LAN

For more reliable networking, the P8Z77 WS features built-in dual server grade Intel® Gigabit LAN. This leads to lower 71% CPU utilization, increasing throughput to achieve outstanding performance as well as better support for diverse operating systems.

#### WS O.C. LED

At a glance workstation overclocking status with easy to understand color coding. Red means overclocked, blue means normal, while green denotes power saving mode. This is an essential and convenient tool to let users know more about overclocking conditions without entering the BIOS.

#### Diag. LED

Diag. LED checks key components (CPU, memory, graphics card and hard drive) in sequence during bootup. If an error is found, the LED next to the relevant device will stay lit until the problem is solved. This user-friendly design provides an intuitive way to locate root problems in seconds.

#### Quick Gate

Quick Gate is a vertical USB connector on the motherboard, allowing you to install USB devices directly with no messy cables. This stops important data storage devices from breaking off unexpectedly. P8P67 WS Revolution with this unique design provides a convenient and safe way to install data and applications on your PC.

### 1.3.7 Other special features

#### LucidLogix Virtu MVP

LucidLogix Virtu MVP featuring HyperFormance™ Technology boosts your discrete graphics card up to 30% beyond its original performance. Designed for Intel® processor graphics and Windows® 7 PCs, it perfectly combines the performance of discrete graphic cards with fast computing iGPU. Also, with newly designed Virtual Sync, users can enjoy a smoother gaming experience by eliminating tearing artifacts. LucidLogix Virtu MVP can also dynamically assign tasks to the best available graphics resource, based on power, performance, and system load. This allows users to fully utilize 3x faster video conversion with Intel® Quick Sync Video 2.0 technology while retaining high-end 3D rendering and gaming performance, provided by both NVIDIA and AMD graphic cards. When the discrete graphic cards are not required, it puts the power use down to zero, making the system more environmentally friendly. For users searching for perfection, LucidLogix Virtu MVP provides great graphical performance, and best flexibility and efficiency.

\* **LucidLogix Virtu MVP supports Windows® 7 operating system.**

\*\* **Intel® Quick Sync Video feature is supported by 3rd/2nd generation Intel® Core™ processor family**

#### DTS UltraPC II

DTS UltraPC II delivers an exceptional 7.1 surround experience through the most popular PC audio setups—your existing stereo speakers or headphones. In addition to virtual surround, it upgrades the original sound to new levels with Audio Restoration, recreating dynamic range of audio files. Symmetry mode improves the balance of perceived loudness across different input sources, and enhances boost audio quality through high hand low frequency equalization. With these technologies, users experience better home theater audio with ease.

## 2.1 Before you proceed

Take note of the following precautions before you install motherboard components or change any motherboard settings.



- 
- Unplug the power cord from the wall socket before touching any component.
  - Before handling components, use a grounded wrist strap or touch a safely grounded object or a metal object, such as the power supply case, to avoid damaging them due to static electricity.
  - Hold components by the edges to avoid touching the ICs on them.
  - Whenever you uninstall any component, place it on a grounded antistatic pad or in the bag that came with the component.
  - Before you install or remove any component, ensure that the ATX power supply is switched off or the power cord is detached from the power supply. Failure to do so may cause severe damage to the motherboard, peripherals, or components.
-

# 2.2 Motherboard overview

## 2.2.1 Motherboard layout

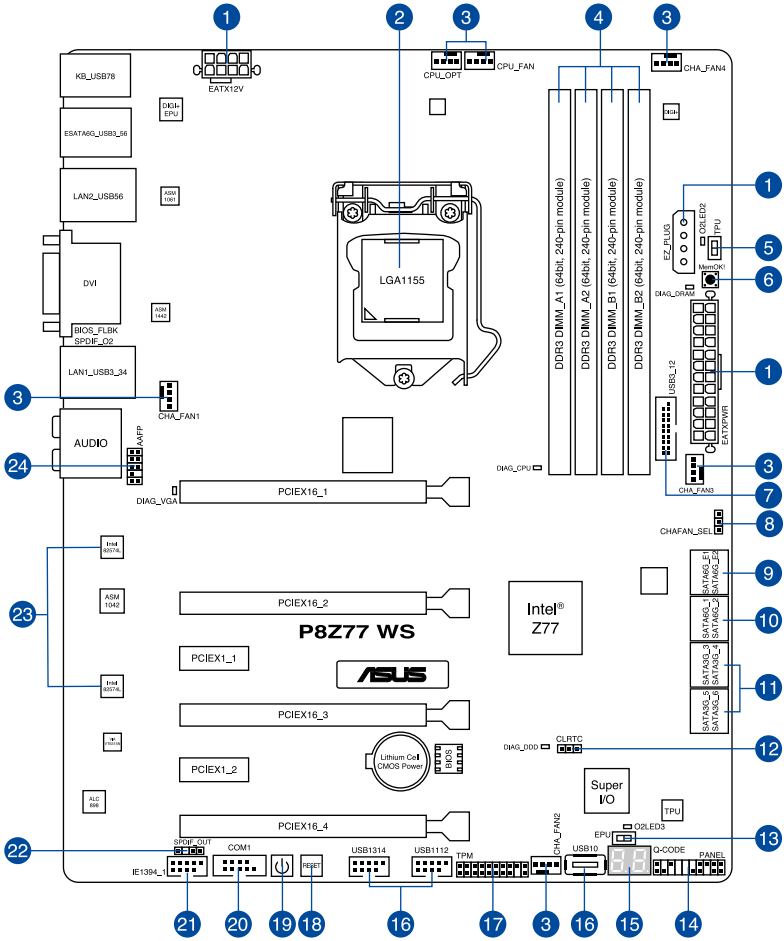

Refer to 2.2.7 Internal connectors and 2.3.10 Rear panel connection for more information about rear panel connectors and internal connectors.



## Layout contents

Connectors/Jumpers/Slots		Page
1.	ATX power connectors (24-pin EATXPWR, 8-pin EATX12V, 4-pin EZ_PLUG)	2-27
2.	LGA1155 CPU socket	2-4
3.	CPU, chassis, and power fan connectors (4-pin CPU_FAN, 4-pin CPU_OPT, 3/4 pin CHA_FAN4)	2-26
4.	DDR3 DIMM slots	2-5
5.	TPU switch	2-11
6.	MemOK! switch	2-10
7.	USB 3.0 connector (20-1 pin USB3_12)	2-24
8.	Chassis fan switch	2-20
9.	Marvell® Serial ATA 6.0 Gb/s connectors (7-pin SATA6G_E1/E2 [navy blue])	2-23
10.	Intel® Z77 Serial ATA 6.0 Gb/s connectors (7-pin SATA6G_1/2 [gray])	2-21
11.	Intel® Z77 Serial ATA 3.0 Gb/s connectors (7-pin SATA3G_3-6 [blue])	2-22
12.	Clear CMOS switch	2-13
13.	EPU switch	2-12
14.	System panel connector (20-8 pin PANEL)	2-29
15.	Q-Code LED (LED1, LED2)	2-15
16.	USB 2.0 connectors (USB10 [Type A], 10-1 pin USB1112, 10-1 pin USB1314)	2-24
17.	Trusted Platform Module connector (20-1 pin TPM)	2-28
18.	Reset switch	2-9
19.	Power-on switch	2-9
20.	Serial connector (10-1 pin COM1)	2-19
21.	IEEE 1394 connector (10-1 pin IE1394_1)	2-25
22.	Digital audio connector (4-1 pin SPDIF_OUT)	2-25
23.	LAN1 and LAN2 WG82574 LAN chip	2-43
24.	Front panel audio connector (10-1 pin AAFP)	2-27

## 2.2.2 Central Processing Unit (CPU)

The motherboard comes with a surface mount LGA1155 socket designed for the Intel® 3rd/2nd Generation Core™ i7 / Core™ i5 / Core™ i3 / Pentium / Celeron Processors.

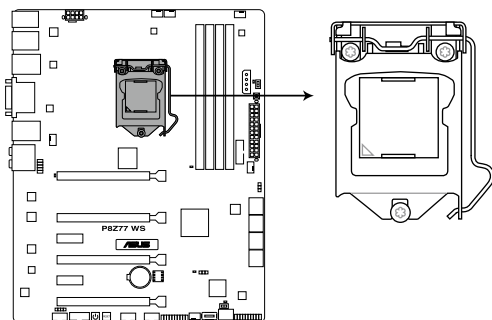

**P8Z77 WS CPU LGA1155**



---

Ensure that all power cables are unplugged before installing the CPU.

---



- The LGA1156 CPU is incompatible with the LGA1155 socket. DO NOT install a LGA1156 CPU on the LGA1155 socket.
  - Upon purchase of the motherboard, ensure that the PnP cap is on the socket and the socket contacts are not bent. Contact your retailer immediately if the PnP cap is missing, or if you see any damage to the PnP cap/socket contacts/motherboard components. ASUS will shoulder the cost of repair only if the damage is shipment/transit-related.
  - Keep the cap after installing the motherboard. ASUS will process Return Merchandise Authorization (RMA) requests only if the motherboard comes with the cap on the LGA1155 socket.
  - The product warranty does not cover damage to the socket contacts resulting from incorrect CPU installation/removal, or misplacement/loss/incorrect removal of the PnP cap.
-

## 2.2.3 System memory

The motherboard comes with four Double Data Rate 3 (DDR3) Dual Inline Memory Modules (DIMM) slots.



A DDR3 module is notched differently from a DDR or DDR2 module. DO NOT install a DDR or DDR2 memory module to the DDR3 slot.

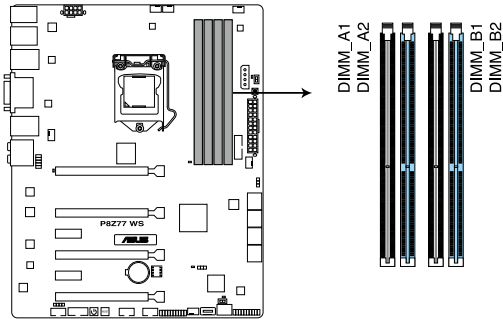

P8Z77 WS 240-pin DDR3 DIMM socket

### Recommended memory configurations

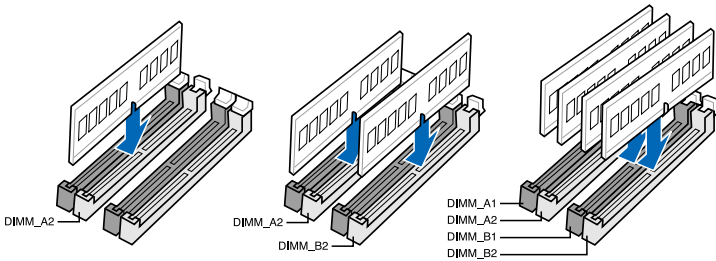

## Memory configurations

You may install 1GB, 2GB, 4GB and 8GB unbuffered and non-ECC DDR3 DIMMs into the DIMM sockets.



- You may install varying memory sizes in Channel A and Channel B. The system maps the total size of the lower-sized channel for the dual-channel configuration. Any excess memory from the higher-sized channel is then mapped for single-channel operation.
- Due to Intel® 2nd generation processors' behavior, DDR3 2200 and above, 2000/1800 MHz memory module will run at DDR3 2133/1866/1600 MHz frequency as default.
- According to Intel CPU spec, DIMM voltage below 1.65V is recommended to protect the CPU.
- Always install DIMMs with the same CAS latency. For optimum compatibility, we recommend that you obtain memory modules from the same vendor.
- Due to the memory address limitation on 32-bit Windows OS, when you install 4GB or more memory on the motherboard, the actual usable memory for the OS can be about 3GB or less. For effective use of memory, we recommend that you do any of the following:
  - Use a maximum of 3GB system memory if you are using a 32-bit Windows OS.
  - Install a 64-bit Windows OS when you want to install 4GB or more on the motherboard.For more details, refer to the Microsoft® support site at <http://support.microsoft.com/kb/929605/en-us>.
- This motherboard does not support DIMMs made up of 512Mb (64MB) chips or less (Memory chip capacity counts in Megabit, 8 Megabit/Mb = 1 Megabyte/MB).



- The default memory operation frequency is dependent on its Serial Presence Detect (SPD), which is the standard way of accessing information from a memory module. Under the default state, some memory modules for overclocking may operate at a lower frequency than the vendor-marked value. To operate at the vendor-marked or at a higher frequency, refer to section **3.4 Ai Tweaker menu** for manual memory frequency adjustment.
- For system stability, use a more efficient memory cooling system to support a full memory load (4 DIMMs) or overclocking condition.

## P8Z77 WS Motherboard Qualified Vendors Lists (QVL)



- ASUS exclusively provides hyper DIMM support function.
- Hyper DIMM support is subject to the physical characteristics of individual CPUs. Load the X.M.P. or D.O.C.P. settings in the BIOS for the hyper DIMM support.
- Visit the ASUS website for the latest QVL.

## 2.2.4 Expansion slots



Ensure to unplug the power cord before adding or removing expansion cards. Failure to do so may cause you physical injury and damage motherboard components.

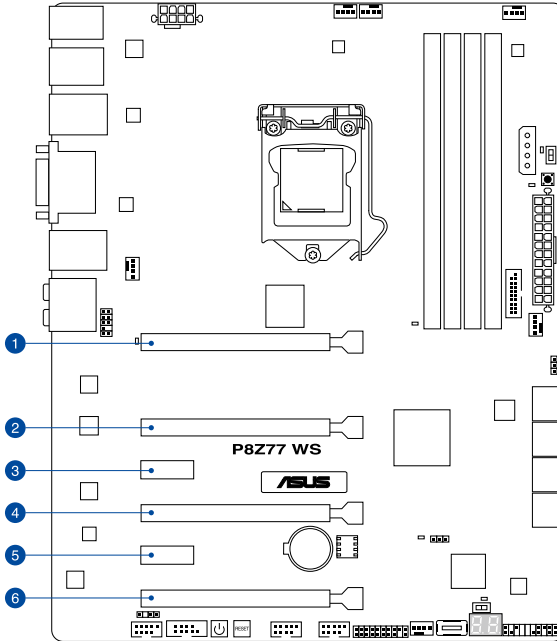

Slot No.	Slot Description
1	PCIe 3.0/2.0 x16_1 slot (single at x16 or dual at x8/x8 mode)
2	PCIe 3.0/2.0 x16_2 slot (at x8 mode)
3	PCIe 2.0 x1_1 slot
4	PCIe 3.0/2.0 x16_3 slot (single at x16 or dual at x8/x8 mode)
5	PCIe 2.0 x1_2 slot
6	PCIe 2.0 x16_4 slot [black] (at x8 mode)

VGA configuration	PCI Express operating mode	
	PCIe 3.0/2.0 x16_1	PCIe 3.0/2.0 x16_2
Single VGA/PCIe card	x16 (Recommend for single VGA)	N/A
Dual VGA/PCIe card	x8	x8



- In single VGA card mode, use the PCIe 3.0/2.0 x16\_1 slot (navy blue) for a PCI Express x16 graphics card to get better performance.
- In CrossFireX™ or SLI™ mode, use the PCIe 3.0/2.0 x16\_1 and PCIe 3.0/2.0 x16\_2 slots for PCI Express x16 graphics cards to get better performance.
- We recommend that you provide sufficient power when running CrossFireX™ or SLI™ mode. Refer to page 2-31 for details.
- Connect a chassis fan to the motherboard connector labeled CHA\_FAN1/2 when using multiple graphics cards for better thermal environment. See page 2-30 for details.
- The PCIe 3.0 speed is supported by Intel® 3rd generation Core™ processors.

## IRQ assignments for this motherboard

	A	B	C	D	E	F	G	H
Intel PCH SATA Controller #0	-	-	-	shared	-	-	-	-
Intel PCH SATA Controller #1	-	-	-	shared	-	-	-	-
SMBUS Controller		-	shared	-	-	-	-	-
Thermal Controller		-	shared	-	-	-	-	-
EHCI #0	-	-	-	-	-	-	-	shared
EHCI #1	shared	-	-	-	-	-	-	-
PCIe x16_1	shared	-	-	-	-	-	-	-
PCIe x16_2		shared	-	-	-	-	-	-
PCIe x16_3	shared	-	-	-	-	-	-	-
PCIe x16_4	shared	-	-	-	-	-	-	-
PCIe x1_1	shared	-	-	-	-	-	-	-
PCIe x1_2	-	shared	-	-	-	-	-	-
ASMedia SATA Connector	-	-	shared	-	-	-	-	-
VIA 1394	-	-	-	shared	-	-	-	-
ASMedia USB 3.0	shared	-	-	-	-	-	-	-
Intel 82574L #0	-	shared	-	-	-	-	-	-
Intel 82574L #1	-	-	shared	-	-	-	-	-
Marvell 9128 Hardware RAID Controller	-	-	-	shared	-	-	-	-

## 2.2.5 Onboard switches

Onboard switches allow you to fine-tune performance when working on a bare or open-case system. This is ideal for overclockers and gamers who continually change settings to enhance system performance.

### 1. Power-on switch

The motherboard comes with a power-on switch that allows you to power up or wake up the system. The switch also lights up when the system is plugged to a power source indicating that you should shut down the system and unplug the power cable before removing or plugging in any motherboard component. The illustration below shows the location of the onboard power-on switch.

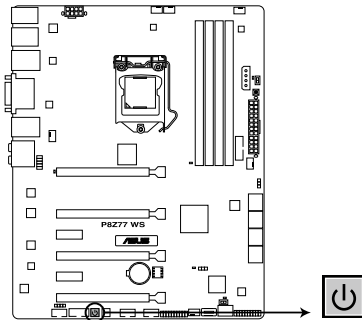

**P8Z77 WS Power on switch**

### 2. Reset switch

Press the reset switch to reboot the system.

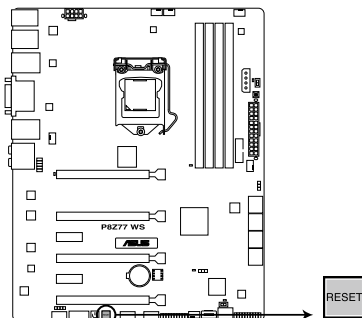

**P8Z77 WS Reset switch**

### 3. MemOK! switch

Installing DIMMs that are incompatible with the motherboard may cause system boot failure, and the DIAG\_DRAM LED near the MemOK! switch lights continuously. Press and hold the MemOK! switch until the DIAG\_DRAM LED starts blinking to begin automatic memory compatibility tuning for successful boot.

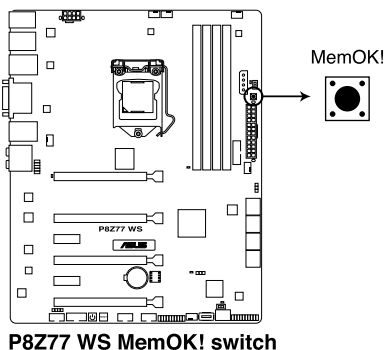

- Refer to section **2.2.6 Onboard LEDs** for the exact location of the DIAG\_DRAM LED.
- The DIAG\_DRAM LED also lights when the DIMM is not properly installed. Turn off the system and reinstall the DIMM before using the MemOK! function.
- The MemOK! switch does not function under Windows™ OS environment.
- During the tuning process, the system loads and tests failsafe memory settings. It takes about 30 seconds for the system to test one set of failsafe settings. If the test fails, the system reboots and test the next set of failsafe settings. The blinking speed of the DIAG\_DRAM LED increases, indicating different test processes.
- Due to memory tuning requirement, the system automatically reboots when each timing set is tested. If the installed DIMMs still fail to boot after the whole tuning process, the DIAG\_DRAM LED lights continuously. Replace the DIMMs with ones recommended in the Memory QVL (Qualified Vendors Lists) in this user manual or on the ASUS website at [www.asus.com](http://www.asus.com).
- If you turn off the computer and replace DIMMs during the tuning process, the system continues memory tuning after turning on the computer. To stop memory tuning, turn off the computer and unplug the power cord for about 5–10 seconds.
- If your system fail to boot due to BIOS overlocking, press the MemOK! switch to boot and load BIOS default settings. A message will appear during POST reminding you that the BIOS has been restored to its default settings.
- We recommend that you download and update to the latest BIOS version from the ASUS website at [www.asus.com](http://www.asus.com) after using the MemOK! function.



#### 4. TPU switch

Turning this switch to **Enable** will automatically optimize the system for fast, yet stable clock speeds.



For ensuring the system performance, turn the switch setting to **Enable** when the system is powered off.

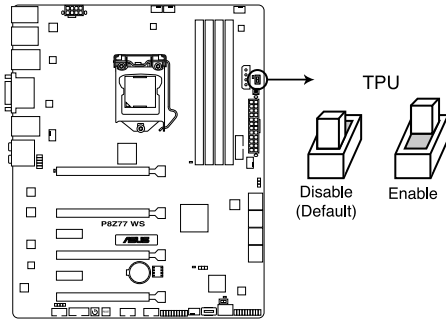

**P8Z77 WS TPU switch**



- The TPU LED (O2LED2) near the TPU switch lights when the switch setting is turned to **Enable**. Refer to section 2.2.6 **Onboard LEDs** for the exact location of the TPU LED.
- If you change the switch setting to **Enable** under the OS environment, the TPU function will be activated after the next system bootup.
- You may use the TurboV and Auto Tuning feature in the TurboV EVO application, adjust the BIOS setup program, or enable the TPU switch at the same time. However, the system will use the last setting you have made.

## 5. EPU switch

Turning this switch to **Enable** will automatically detect the current PC loadings and intelligently moderate the power consumption.



---

For ensuring the system performance, turn the switch setting to **Enable** when the system is powered off.

---

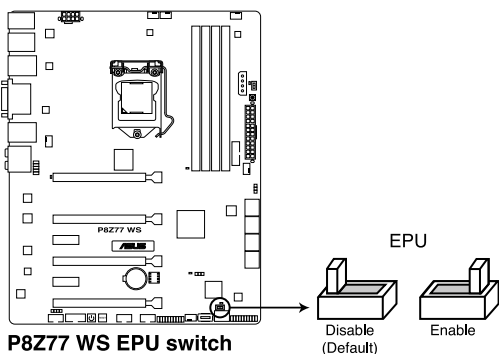

- The EPU LED (O2LED3) near the EPU switch lights when the switch setting is turned to **Enable**. Refer to section 2.2.6 Onboard LEDs for the exact location of the EPU LED.
  - If you change the switch setting to **Enable** under the OS environment, the EPU function will be activated after the next system bootup.
  - You may change the EPU settings in the software application or BIOS setup program, and enable the EPU function at the same time. However, the system will use the last setting you have made.
-

**6. Clear CMOS switch**

Turning this switch to clear the BIOS setup information, only when the systems hangs due to overclocking.

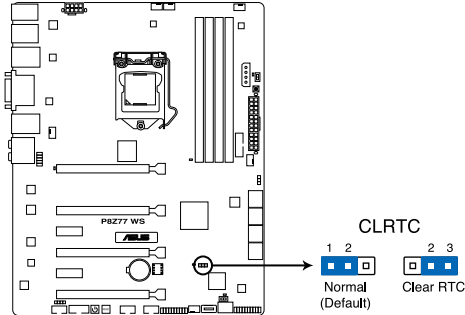

**P8Z77 WS Clear RTC RAM**

## 2.2.6 Onboard LEDs

### 1. POST State LEDs

The POST State LEDs of CPU, DRAM, VGA card, and HDD indicate key components status during POST (Power-on Self Test). If an error is found, the LED next to the error device will continue lighting until the problem is solved. This user-friendly design provides an intuitive way to locate the root problem within a second.

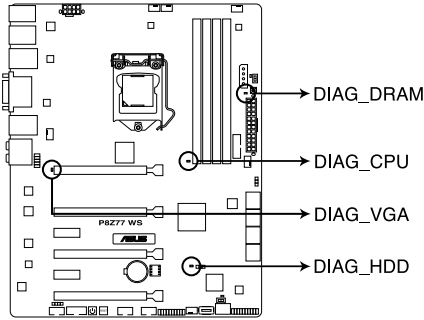

**P8Z77 WS CPU/ DRAM/  
HDD/ VGA LED**

### 2. TPU LED

The TPU LED lights when the TPU switch is turned to **Enable**.

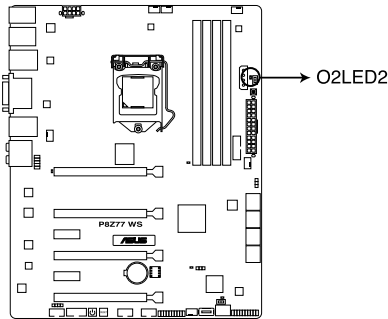

**P8Z77 WS TPU LED**

### 3. EPU LED

The EPU LED lights when the EPU switch is turned to **Enable**.

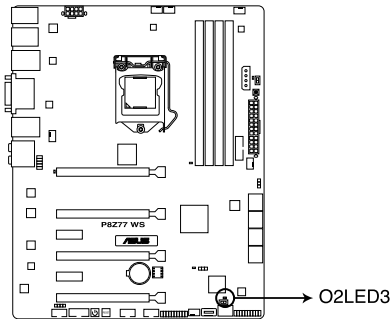

**P8Z77 WS EPU LED**

### 4. Q-Code LEDs

The Q-Code LED design provides you the 2-digit display, allowing you to know the system status. Refer to the Q-Code table below for details.

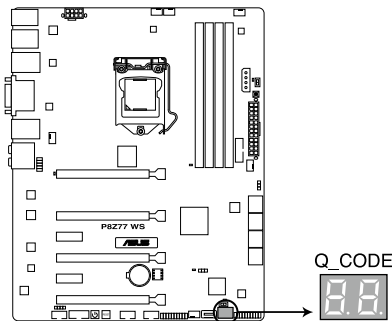

**P8Z77 WS Q-Code LED**

## Q-Code table

Code	Description
00	Not used
01	Power on. Reset type detection (soft/hard).
02	AP initialization before microcode loading
03	System Agent initialization before microcode loading
04	PCH initialization before microcode loading
06	Microcode loading
07	AP initialization after microcode loading
08	System Agent initialization after microcode loading
09	PCH initialization after microcode loading
0B	Cache initialization
0C – 0D	Reserved for future AMI SEC error codes
0E	Microcode not found
0F	Microcode not loaded
10	PEI Core is started
11 – 14	Pre-memory CPU initialization is started
15 – 18	Pre-memory System Agent initialization is started
19 – 1C	Pre-memory PCH initialization is started
2B – 2F	Memory initialization
30	Reserved for ASL (see ASL Status Codes section below)
31	Memory Installed
32 – 36	CPU post-memory initialization
37 – 3A	Post-Memory System Agent initialization is started

**Q-Code table (continued)**

Code	Description
3B – 3E	Post-Memory PCH initialization is started
4F	DXE IPL is started
50 – 53	Memory initialization error. Invalid memory type or incompatible memory speed
54	Unspecified memory initialization error
55	Memory not installed
56	Invalid CPU type or Speed
57	CPU mismatch
58	CPU self test failed or possible CPU cache error
59	CPU micro-code is not found or micro-code update is failed
5A	Internal CPU error
5B	Reset PPI is not available
5C – 5F	Reserved for future AMI error codes
E0	S3 Resume is started (S3 Resume PPI is called by the DXE IPL)
E1	S3 Boot Script execution
E2	Video repost
E3	OS S3 wake vector call
E4 – E7	Reserved for future AMI progress codes
E8	S3 Resume Failed
E9	S3 Resume PPI not Found
EA	S3 Resume Boot Script Error
EB	S3 OS Wake Error
EC – EF	Reserved for future AMI error codes
F0	Recovery condition triggered by firmware (Auto recovery)
F1	Recovery condition triggered by user (Forced recovery)
F2	Recovery process started
F3	Recovery firmware image is found
F4	Recovery firmware image is loaded
F5 – F7	Reserved for future AMI progress codes
F8	Recovery PPI is not available
F9	Recovery capsule is not found
FA	Invalid recovery capsule
FB – FF	Reserved for future AMI error codes
60	DXE Core is started
61	NVRAM initialization
62	Installation of the PCH Runtime Services
63 – 67	CPU DXE initialization is started
68	PCI host bridge initialization
69	System Agent DXE initialization is started
6A	System Agent DXE SMM initialization is started

## Q-Code table (continued)

Code	Description
6B – 6F	System Agent DXE initialization (System Agent module specific)
70	PCH DXE initialization is started
71	PCH DXE SMM initialization is started
72	PCH devices initialization
73 – 77	PCH DXE Initialization (PCH module specific)
78	ACPI module initialization
79	CSM initialization
7A – 7F	Reserved for future AMI DXE codes
90	Boot Device Selection (BDS) phase is started
91	Driver connecting is started
92	PCI Bus initialization is started
93	PCI Bus Hot Plug Controller Initialization
94	PCI Bus Enumeration
95	PCI Bus Request Resources
96	PCI Bus Assign Resources
97	Console Output devices connect
98	Console input devices connect
99	Super IO Initialization
9A	USB initialization is started
9B	USB Reset
9C	USB Detect
9D	USB Enable
9E – 9F	Reserved for future AMI codes
A0	IDE initialization is started
A1	IDE Reset
A2	IDE Detect
A3	IDE Enable
A4	SCSI initialization is started
A5	SCSI Reset
A6	SCSI Detect
A7	SCSI Enable
A8	Setup Verifying Password
A9	Start of Setup
AA	Reserved for ASL (see ASL Status Codes section below)
AB	Setup Input Wait
AC	Reserved for ASL (see ASL Status Codes section below)
AD	Ready To Boot event
AE	Legacy Boot event
AF	Exit Boot Services event
B0	Runtime Set Virtual Address MAP Begin



**Q-Code table (continued)**

Code	Description
B1	Runtime Set Virtual Address MAP End
B2	Legacy Option ROM Initialization
B3	System Reset
B4	USB hot plug
B5	PCI bus hot plug
B6	Clean-up of NVRAM
B7	Configuration Reset (reset of NVRAM settings)
B8- BF	Reserved for future AMI codes
D0	CPU initialization error
D1	System Agent initialization error
D2	PCH initialization error
D3	Some of the Architectural Protocols are not available
D4	PCI resource allocation error. Out of Resources
D5	No Space for Legacy Option ROM
D6	No Console Output Devices are found
D7	No Console Input Devices are found
D8	Invalid password
D9	Error loading Boot Option (LoadImage returned error)
DA	Boot Option is failed (StartImage returned error)
DB	Flash update is failed
DC	Reset protocol is not available

**ACPI/ASL Checkpoints**

Code	Description
0x01	System is entering S1 sleep state
0x02	System is entering S2 sleep state
0x03	System is entering S3 sleep state
0x04	System is entering S4 sleep state
0x05	System is entering S5 sleep state
0x10	System is waking up from the S1 sleep state
0x20	System is waking up from the S2 sleep state
0x30	System is waking up from the S3 sleep state
0x40	System is waking up from the S4 sleep state
0xAC	System has transitioned into ACPI mode. Interrupt controller is in PIC mode.
0xAA	System has transitioned into ACPI mode. Interrupt controller is in APIC mode.

## 2.2.7 Jumper

### 1. Chassis Fan control setting (3-pin CHAFAN\_SEL)

These jumpers allow you to switch for fan pin selection. The CHAFAN\_SEL jumper is for the front fans and rear fans control. Set to pins 1–2 when using 3-pin fans or pins 2–3 when using 4-pin fans.

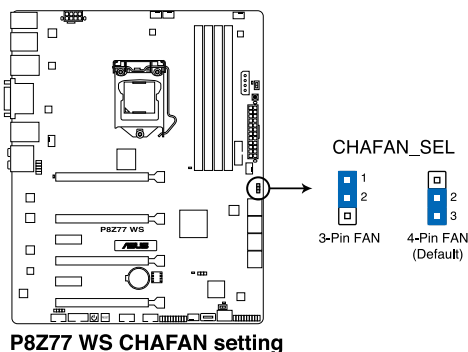

- If you use a 4-pin fan but set the jumper to pin 1-2, the fan you installed may not work.
- If you use a 3-pin fan but set the jumper for a 4-pin fan, the fan control will not work and the fan you installed will always run at full speed.

## 2.2.8 Internal connectors

### 1. Intel® Z77 Serial ATA 6.0 Gb/s connectors (7-pin SATA6G\_1/2 [gray])

These connectors connect to Serial ATA 6.0 Gb/s hard disk drives via Serial ATA 6.0 Gb/s signal cables.

If you installed Serial ATA hard disk drives, you can create a RAID 0, 1, 5, and 10 configuration with the Intel® Rapid Storage Technology through the onboard Intel® Z77 chipset.

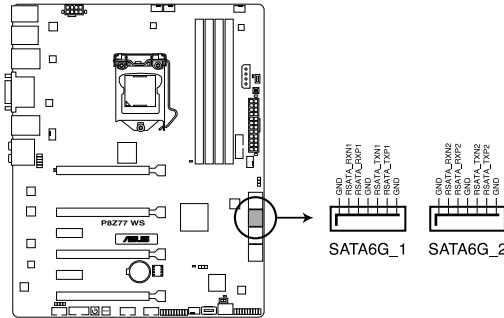

P8Z77 WS Intel® SATA 6.0 Gb/s connectors

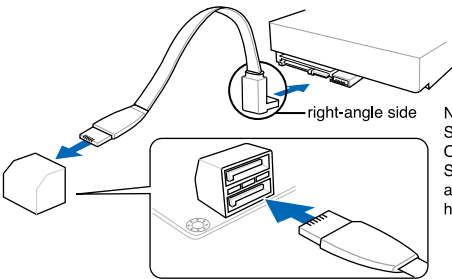

NOTE: Connect the right-angle side of SATA signal cable to SATA device.  
Or you may connect the right-angle side of SATA cable to the onboard SATA port to avoid mechanical conflict with huge graphics cards.



- These connectors are set to [AHCI Mode] by default. If you intend to create a Serial ATA RAID set using these connectors, set the **SATA Mode** item in the BIOS to [RAID Mode]. Refer to section 3.5.3 **SATA Configuration** for details.
- Before creating a RAID set, refer to section 4.4 **RAID configurations** or the manual bundled in the motherboard support DVD.
- When using NCQ, set the **SATA Mode** in the BIOS to [AHCI Mode]. Refer to section 3.5.3 **SATA Configuration** for details.
- You must install Windows® XP Service Pack 3 or later versions before using Serial ATA hard disk drives. The Serial ATA RAID feature is available only if you are using Windows® XP SP3 or later versions.

## 2. Intel® Z77 Serial ATA 3.0 Gb/s connectors (7-pin SATA3G\_3-6 [blue])

These connectors connect to Serial ATA 3.0 Gb/s hard disk drives and optical disc drives via Serial ATA 3.0 Gb/s signal cables.

If you installed Serial ATA hard disk drives, you can create a RAID 0, 1, 5, and 10 configuration with the Intel® Rapid Storage Technology through the onboard Intel® Z77 chipset.

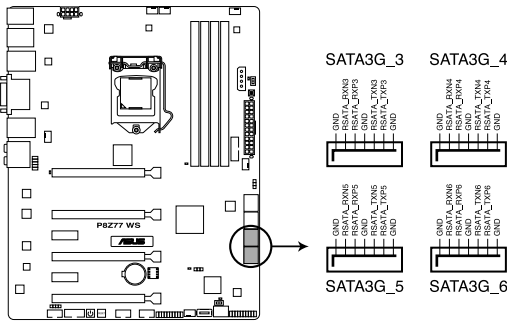

**P8Z77 WS Intel® SATA 3.0 Gb/s connectors**



- These connectors are set to [AHCI Mode] by default. If you intend to create a Serial ATA RAID set using these connectors, set the **SATA Mode** item in the BIOS to [RAID Mode]. Refer to section **3.5.3 SATA Configuration** for details.
- Before creating a RAID set, refer to section **4.4 RAID configurations** or the manual bundled in the motherboard support DVD.
- When using NCQ, set the **SATA Mode** in the BIOS to [AHCI Mode]. Refer to section **3.5.3 SATA Configuration** for details.
- You must install Windows® XP Service Pack 3 or later versions before using Serial ATA hard disk drives. The Serial ATA RAID feature is available only if you are using Windows® XP SP3 or later versions.

### 3. Marvell® Serial ATA 6.0 Gb/s connectors (7-pin SATA6G\_E1/E2 [navy blue])

These connectors connect to Serial ATA 6.0 Gb/s hard disk drives via Serial ATA 6.0 Gb/s signal cables.

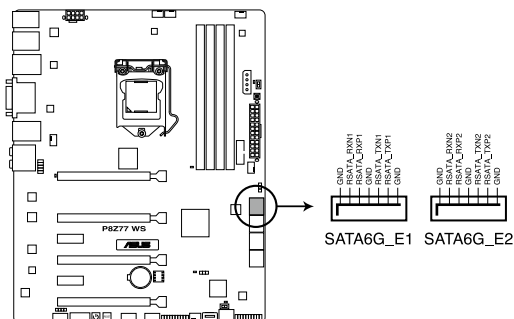

**P8Z77 WS Marvell® SATA 6.0 Gb/s connectors**



- You must install Windows® XP Service Pack 3 or later versions before using Serial ATA hard disk drives.
- When using NCQ, set the **Marvell Storage Controller** item in the BIOS to [Enabled]. Refer to section **3.5.6 Onboard Devices Configuration** for details.
- Press <Ctrl> + <M> during POST to enter the Marvell RAID utility to create or delete a RAID configuration.
- If you want to install a Windows operating system to a RAID configuration created using the Marvell SATA controller, you have to create a RAID driver disk using the motherboard support DVD and load the driver during OS installation. For 32/64bit Windows XP OS, load first the **Marvell shared library** driver, and then load **Marvell 91xx SATA Controller Driver**. For Windows Vista / Windows 7 OS, load only the **Marvell 91xx SATA Controller Driver**.
- Connect one HDD and one SSD to Marvell® SATA6G\_E1/E2 connectors for a high performance of ASUS SSD Caching.
- The SATA6G\_E1/E2 connectors are recommended for regular use.

#### 4. USB 3.0 connector (20-pin USB3\_12)

This connector is for the additional USB 3.0 ports, and complies with the USB 3.0 specification that supports up to 480 Mbps connection speed. If the USB 3.0 front panel cable is available from your system chassis, with this USB 3.0 connector, you can have a front panel USB 3.0 solution.

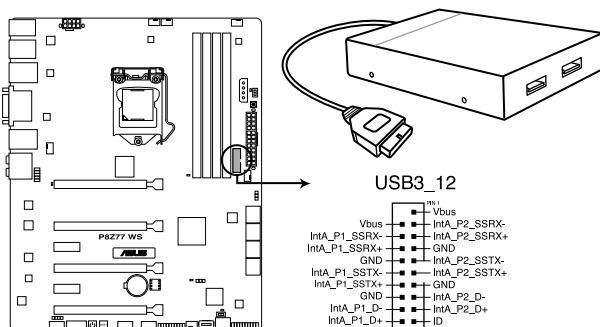

**P8Z77 WS USB3.0 connector**

- The USB 3.0 box is purchased separately.
- Due to Intel® limitations, the USB3\_12 only supports Windows® 7 operating system.

#### 5. USB 2.0 connectors (10-1 pin USB1112; USB1314)

These connectors are for USB 2.0 ports. Connect the USB module cable to any of these connectors, then install the module to a slot opening at the back of the system chassis. These USB connectors comply with USB 2.0 specification that supports up to 48 Mbps connection speed.

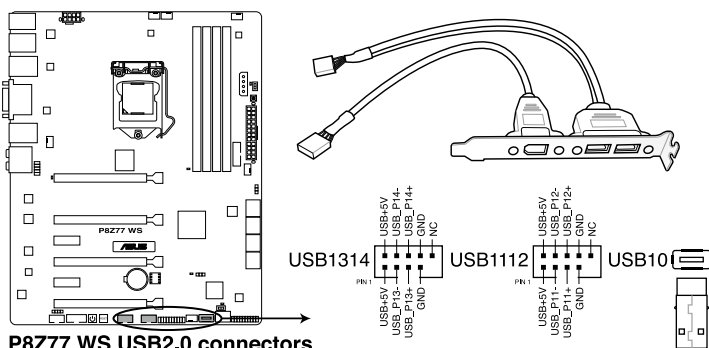

**P8Z77 WS USB2.0 connectors**



Never connect a 1394 cable to the USB connectors. Doing so will damage the motherboard!



You can connect the front panel USB cable to the ASUS Q-Connector (USB, blue) first, and then install the Q-Connector (USB) to the USB connector onboard if your chassis supports front panel USB ports.



The USB 2.0 module is purchased separately.

## 6. Digital audio connector (4-1 pin SPDIF\_OUT)

This connector is for an additional Sony/Philips Digital Interface (S/PDIF) port(s). Connect the S/PDIF Out module cable to this connector, then install the module to a slot opening at the back of the system chassis.

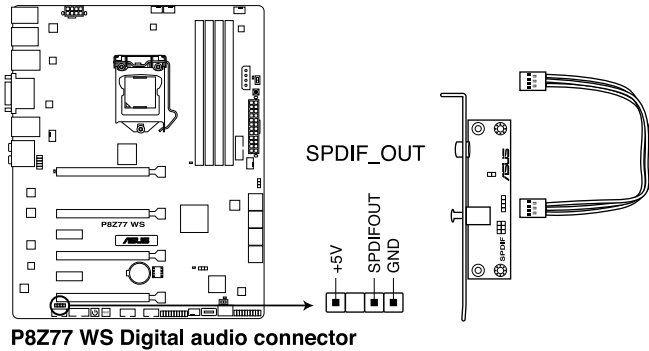

**P8Z77 WS Digital audio connector**



The S/PDIF module is purchased separately.

## 7. IEEE 1394a port connector (10-1 pin IE1394\_2)

This connector is for an IEEE 1394a port. Connect the IEEE 1394a module cable to this connector, then install the module to a slot opening at the back of the system chassis.

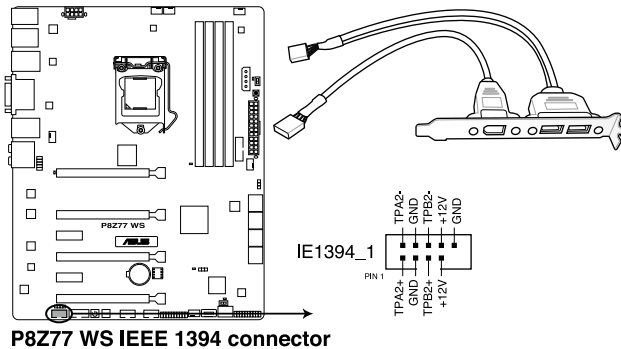

**P8Z77 WS IEEE 1394 connector**



Never connect a USB cable to the IEEE 1394a connector. Doing so will damage the motherboard!



The IEEE 1394 bracket is purchased separately.

## 8. CPU, chassis, and power fan connectors (4-pin CPU\_FAN; 4-pin CPU\_OPT; 3/4 pin CHA\_FAN1-4)

Connect the fan cables to the fan connectors on the motherboard, ensuring that the black wire of each cable matches the ground pin of the connector.

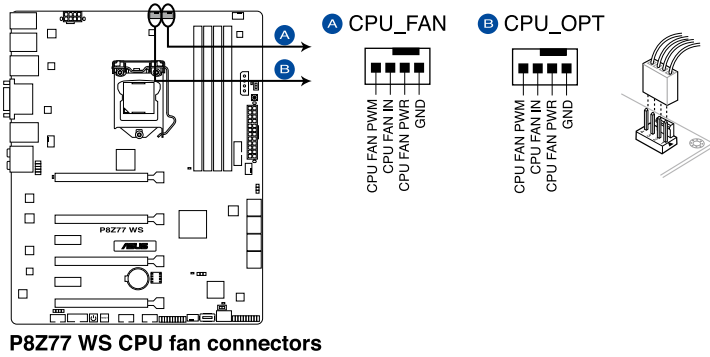

Do not forget to connect the fan cables to the fan connectors. Insufficient air flow inside the system may damage the motherboard components. These are not jumpers! Do not place jumper caps on the fan connectors!



- The CPU\_FAN connector supports the CPU fan of maximum 1A (12 W) fan power.
- Only the CPU\_FAN, CHA\_FAN 1/2/3/4 connectors support the ASUS FAN Xpert 2 feature.
- If you install two VGA cards, we recommend that you plug the rear chassis fan cable to the motherboard connector labeled CHA\_FAN1 or CHA\_FAN2 for better thermal environment.







- For a fully configured system, we recommend that you use a power supply unit (PSU) that complies with ATX 12 V Specification 2.0 (or later version) and provides a minimum power of 350 W.
- Do not forget to connect the 4-pin/8-pin EATX12 V power plug; otherwise, the system will not boot.
- Use of a PSU with a higher power output is recommended when configuring a system with more power-consuming devices. The system may become unstable or may not boot up if the power is inadequate.
- If you want to use two or more high-end PCI Express x16 cards, use a PSU with 1000W power or above to ensure the system stability.
- If you are uncertain about the minimum power supply requirement for your system, refer to the Recommended Power Supply Wattage Calculator at <http://support.asus.com/PowerSupplyCalculator/PSCalculator.aspx?SLanguage=en-us> for details.

## 11. TPM connector (20-pin TPM)

This connector supports a Trusted Platform Module (TPM) system, which can securely store keys, digital certificates, passwords, and data. A TPM system also helps enhance network security, protects digital identities, and ensures platform integrity. This connector can also serve for G.P. Diagnosis card installation.

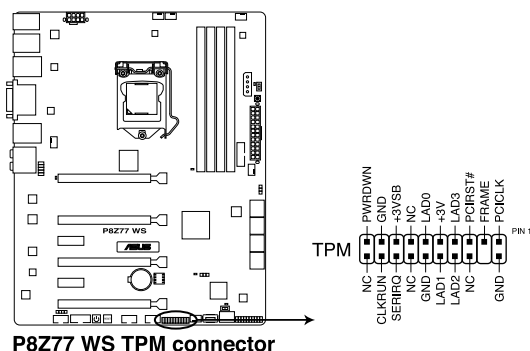

**P8Z77 WS TPM connector**

## 12. System panel connector (20-8 pin PANEL)

This connector supports several chassis-mounted functions.

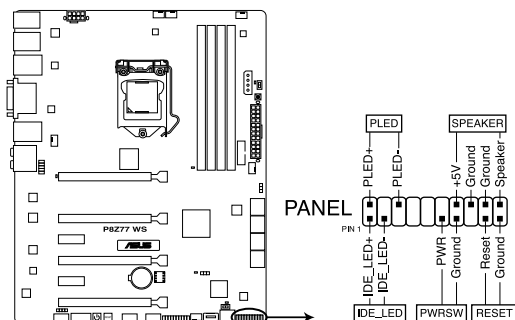

**P8Z77 WS System panel connector**

- **System power LED (2-pin PLED)**

This 2-pin connector is for the system power LED. Connect the chassis power LED cable to this connector. The system power LED lights up when you turn on the system power, and blinks when the system is in sleep mode.

- **Hard disk drive activity LED (2-pin IDE\_LED)**

This 2-pin connector is for the HDD Activity LED. Connect the HDD Activity LED cable to this connector. The IDE LED lights up or flashes when data is read from or written to the HDD.

- **System warning speaker (4-pin SPEAKER)**

This 4-pin connector is for the chassis-mounted system warning speaker. The speaker allows you to hear system beeps and warnings.

- **ATX power button/soft-off button (2-pin PWRSW)**



This connector is for the system power button. Pressing the power button turns the system on or puts the system in sleep or soft-off mode depending on the BIOS settings. Pressing the power switch for more than four seconds while the system is ON turns the system OFF.

- **Reset button (2-pin RESET)**

This 2-pin connector is for the chassis-mounted reset button for system reboot without turning off the system power.

## 2.3 Building your computer system

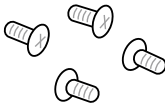
### 2.3.1 Additional tools and components to build a PC system

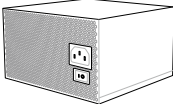
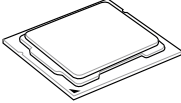
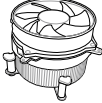
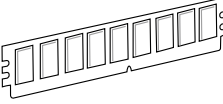
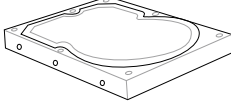
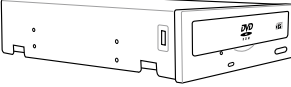
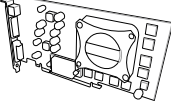
	
<b>1 bag of screws</b>	<b>Philips (cross) screwdriver</b>
	
<b>PC chassis</b>	<b>Power supply unit</b>
	
<b>Intel LGA 1155 CPU</b>	<b>Intel LGA 1155 compatible CPU Fan</b>
	
<b>DIMM</b>	<b>SATA hard disk drive</b>
	
<b>SATA optical disc drive (optional)</b>	<b>Graphics card (optional)</b>



The tools and components in the table above are not included in the motherboard package.

## 2.3.2 CPU installation



The LGA1156 CPU is incompatible with the LGA1155 socket. DO NOT install a LGA1156 CPU on the LGA1155 socket.

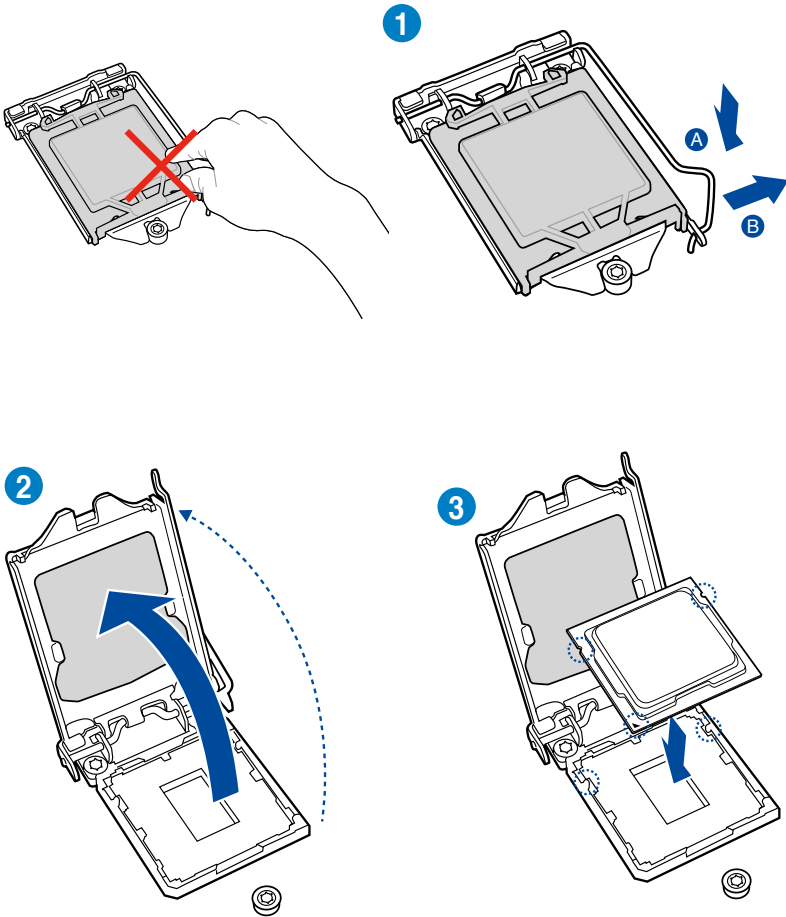

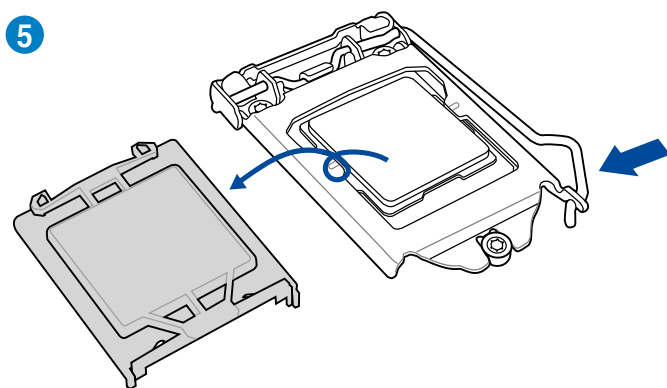
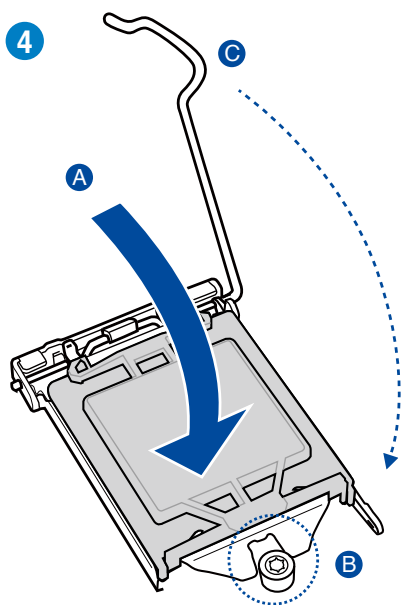

### 2.3.3 CPU heatsink and fan assembly installation

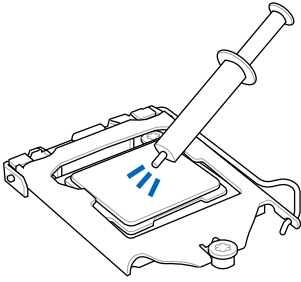

Apply the Thermal Interface Material to the CPU heatsink and CPU before you install the heatsink and fan if necessary.

#### To install the CPU heatsink and fan assembly

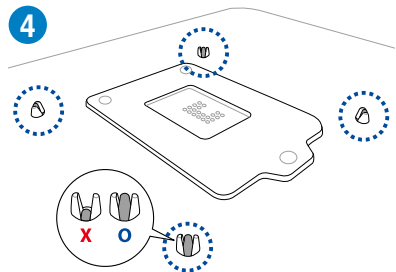
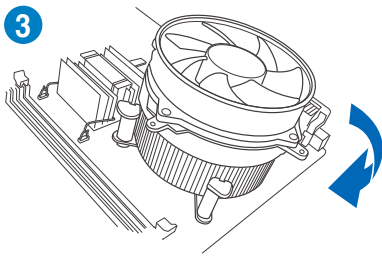
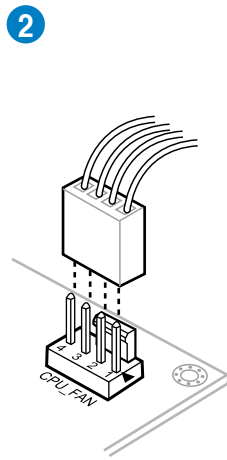
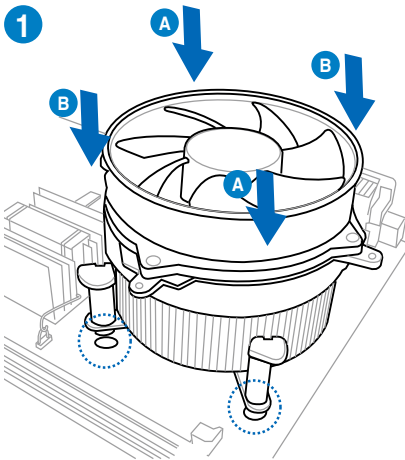

To uninstall the CPU heatsink and fan assembly

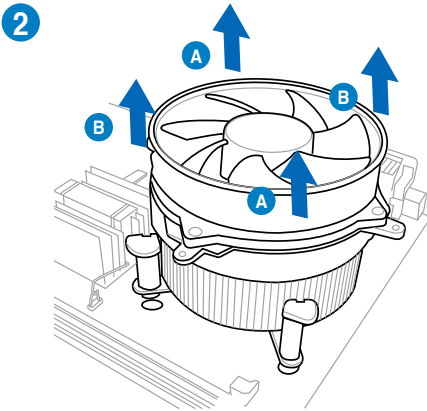
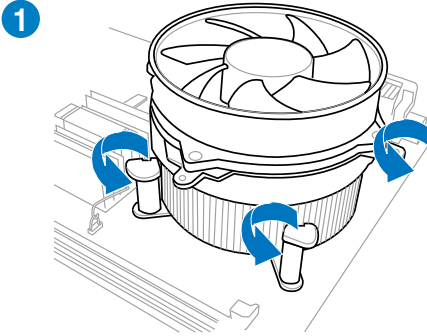



### 2.3.4 DIMM installation

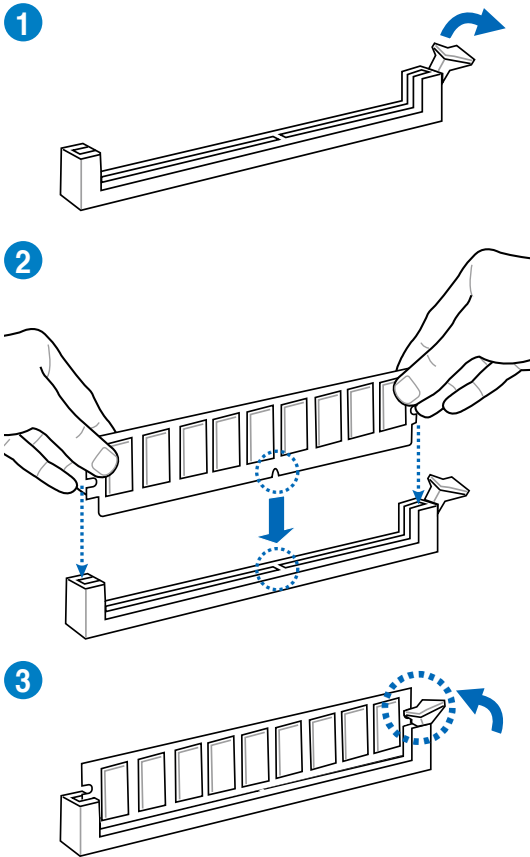

### To remove a DIMM

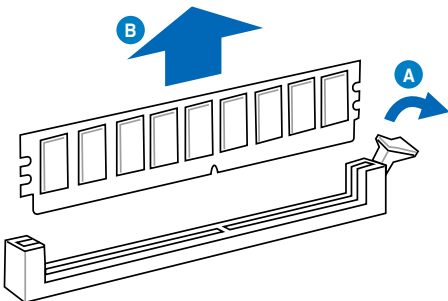

## 2.3.5 Motherboard installation



The diagrams in this section are for reference only. The motherboard layout may vary with models, but the installation steps remain the same.

1

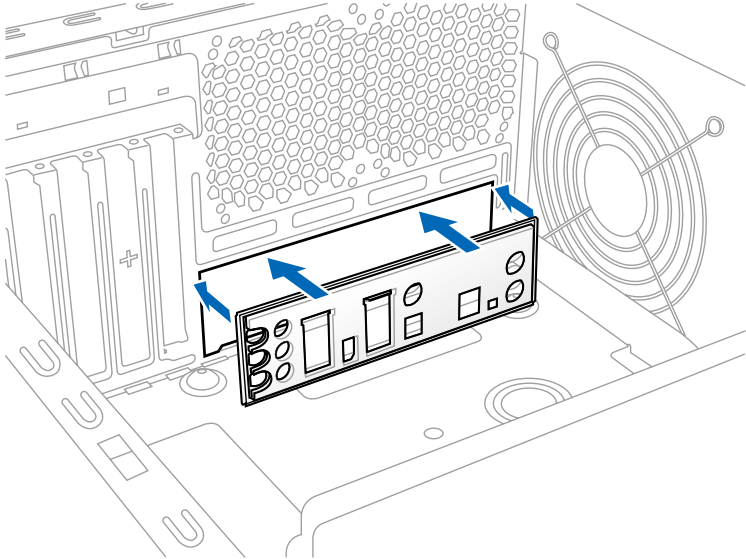

2

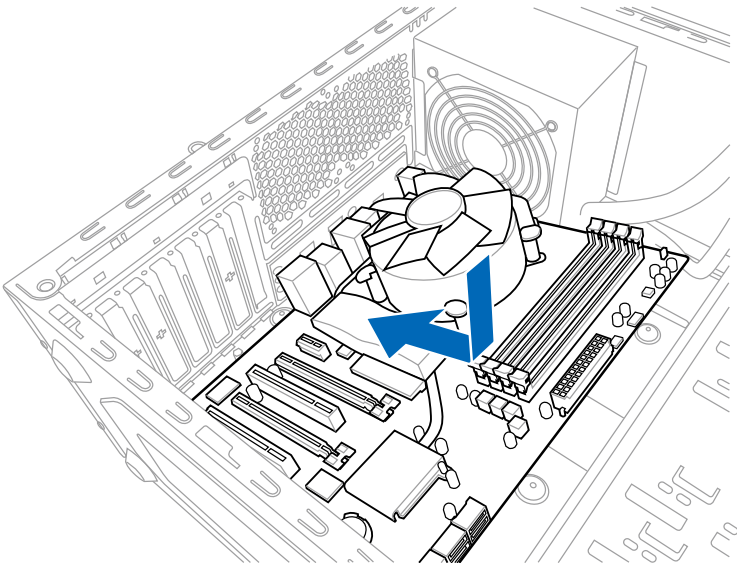

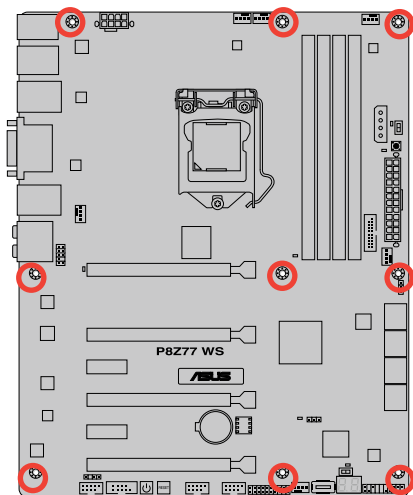
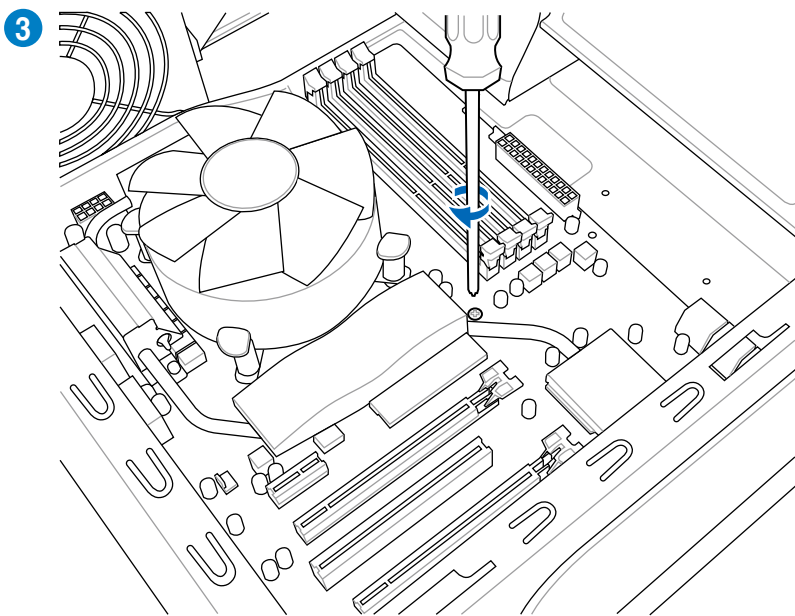

DO NOT overtighten the screws! Doing so can damage the motherboard.

### 2.3.6 ATX Power connection

1

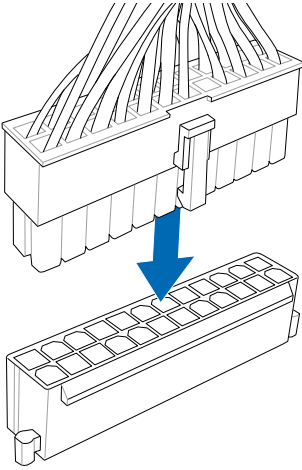

2

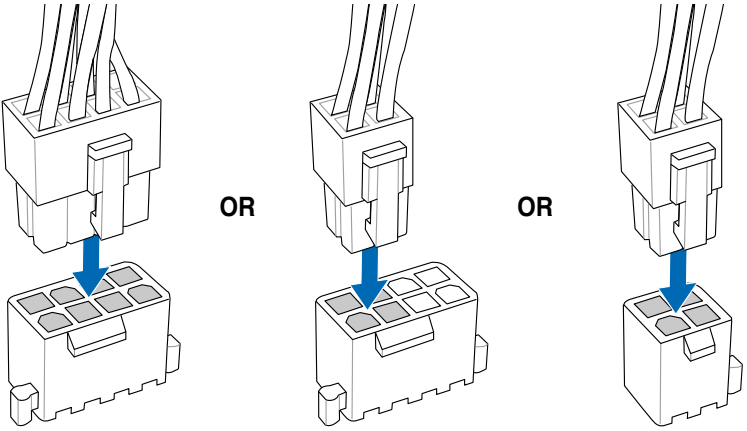

### 2.3.7 SATA device connection

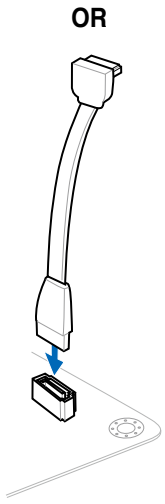
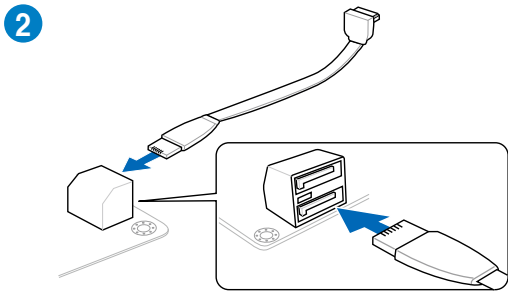
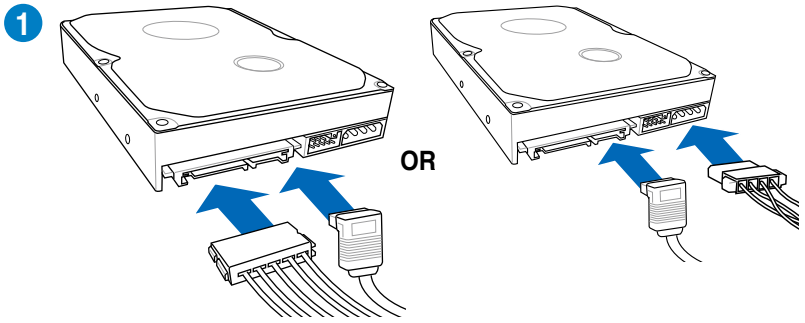

## 2.3.8 Front I/O Connector

### To install ASUS Q-Connector

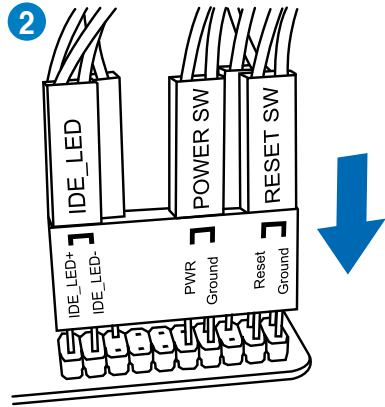
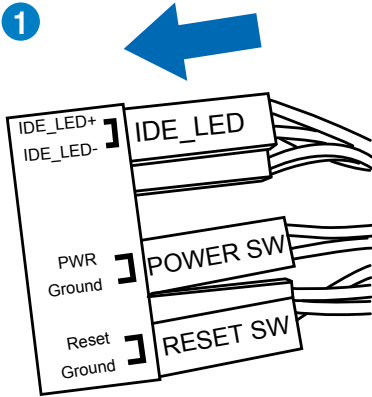

### To install USB 2.0 Connector

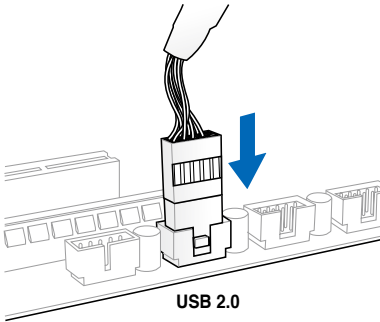

### To install front panel audio connector

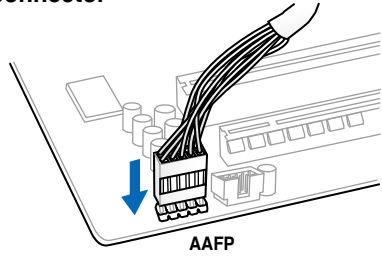

### To install USB 3.0 Connector

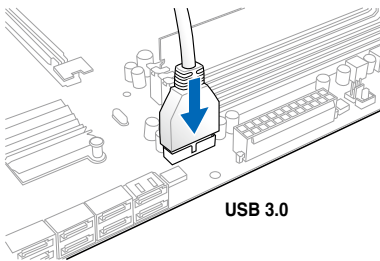

## 2.3.9 Expansion Card installation

### To install PCIe x16 cards

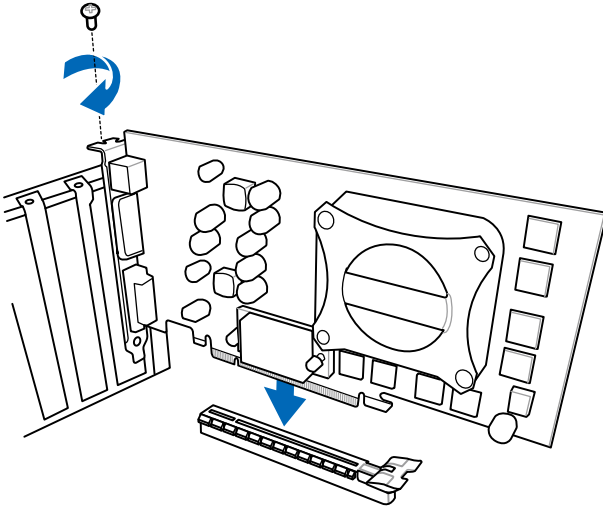

### To install PCIe x1 cards

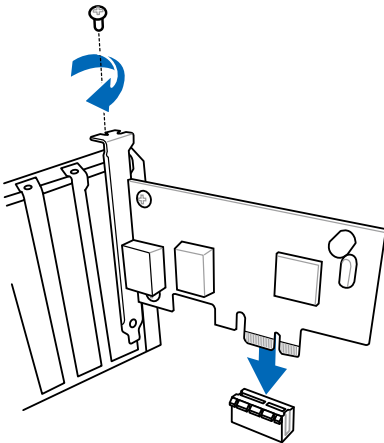

## 2.3.11 USB BIOS Flashback

USB BIOS Flashback offers the most convenient way to flash the BIOS. It allows overclockers to try new BIOS versions easily without having to enter their existing BIOS or operating system. Just plug in USB storage and push the dedicated button for 3 seconds, and the BIOS is automatically flashed using standby power. Worry-free overclocking for the ultimate convenience!

- 1 Download the BIOS Flashback program from the ASUS service website ([www.asus.com](http://www.asus.com)). Save it to a USB portable disk, and place it in the root directory.
- 2 Plug the USB flash drive to the bottom port connector in the back I/O.
- 3 Press the BIOS Flashback button for 3 seconds, and the light will begin to flash (on the third second).
- 4 The Flashback function is enabled once the light starts to flash.
- 5 The flashing rate of the light signal accelerates along with the updating speed.
- 6 BIOS update is complete once the light signal goes out.

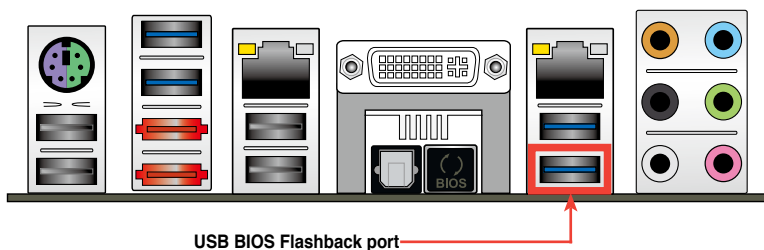

1. Do not unplug portable disk, power system, or press the CLR\_CMOS button while BIOS update is ongoing, otherwise update will be interrupted. In case of interruption, please follow the recommended procedures again to complete BIOS update.
2. If the light flashes for five seconds and turns into a stable lighting, this means that the BIOS Flashback is not operating properly. This may be caused by: 1. Improper installation of the portable disk. 2. Error in file name or incompatibility in file format. If this is the case, please restart the system to turn off the light.
3. Updating BIOS may have risks. If the BIOS program is damaged during the process causing the system unable to reboot, please contact the local service station for help.



## 2.3.12 Rear panel connection

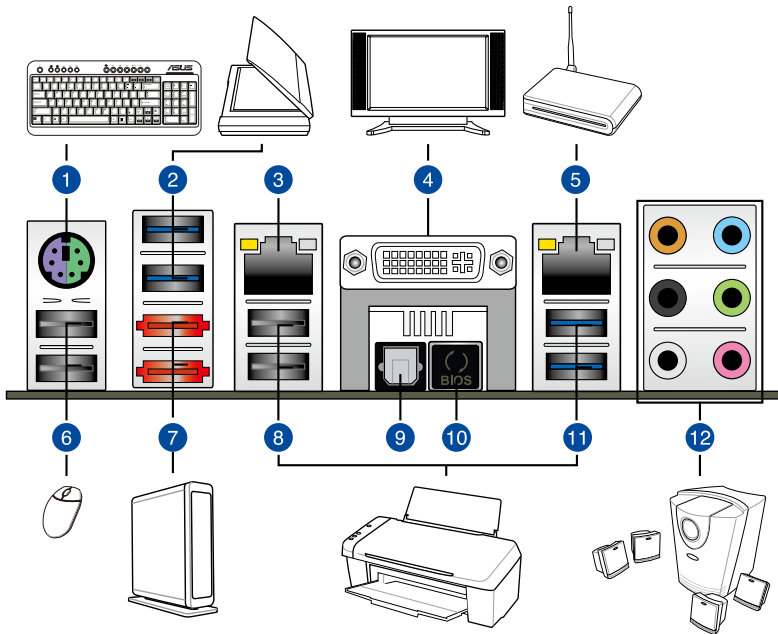

Rear panel connectors	
1. PS/2 keyboard and mouse port	7. ASMedia eSATA 6G port
2. ASMedia USB 3.0 ports 1 and 2, support ASUS USB 3.0 Boost UASP Mode	8. USB 2.0 ports 5 and 6
3. Intel® LAN (RJ-45) port*	9. Optical S/PDIF Out port
4. DVI Display Port	10. USB BIOS Flashback button
5. Intel® LAN (RJ-45) port*	11. Intel USB 3.0 ports 3 and 4, support ASUS USB 3.0 Boost UASP Mode. Bottom port supports USB BIOS Flashback and USB Charger+
6. USB 2.0 ports 7 and 8	12. Audio I/O ports**

\*, \*\* and \*\*\*: Refer to the tables on the next page for LAN port LED, and audio port definitions.



Due to Intel® limitations, the USB3\_1-2 only support Windows® 7 operating system.



- Press the Clear CMOS switch to clear BIOS setup information only when the system hangs due to overclocking.
- DO NOT insert a different connector to the external SATA port.
- Due to USB 3.0 controller limitation, USB 3.0 devices can only be used under Windows® OS environment and after the USB 3.0 driver installation.
- USB 3.0 devices can only be used as data storage only.
- We strongly recommend that you connect USB 3.0 devices to USB 3.0 ports for faster and better performance for your USB 3.0 devices.
- If you want to use the hot-plug function of the external SATA ports, you have to set the **ASMedia® 1061 SATA controllers** item in the BIOS setting to [Enabled] and install the **ASMedia® 1061 SATA controllers** from the motherboard support DVD. Refer to section 3.5.6 **Onboard Devices Configuration** for details.

## \*\* LAN ports LED indications

Activity Link LED		Speed LED	
Status	Description	Status	Description
OFF	No link	OFF	10 Mbps connection
ORANGE	Linked	ORANGE	100 Mbps connection
BLINKING	Data activity	GREEN	1 Gbps connection

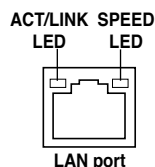

## \*\*\* Audio 2, 4, 6, or 8-channel configuration

Port	Headset 2-channel	4-channel	6-channel	8-channel
Light Blue	Line In	Line In	Line In	Line In
Lime	Line Out	Front Speaker Out	Front Speaker Out	Front Speaker Out
Pink	Mic In	Mic In	Mic In	Mic In
Orange	–	–	Center/Subwoofer	Center/Subwoofer
Black	–	Rear Speaker Out	Rear Speaker Out	Rear Speaker Out
Gray	–	–	–	Side Speaker Out

## 2.3.13 Audio I/O connections

### Audio I/O ports

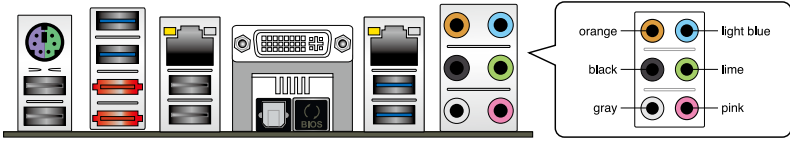

### Connect to Headphone and Mic



### Connect to Stereo Speakers

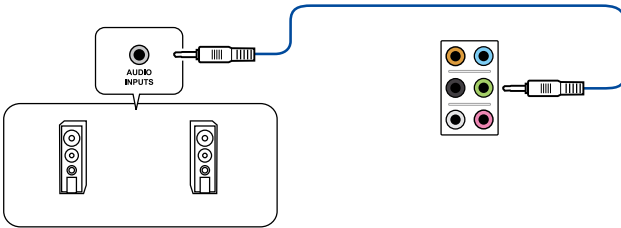

### Connect to 2.1 channel Speakers

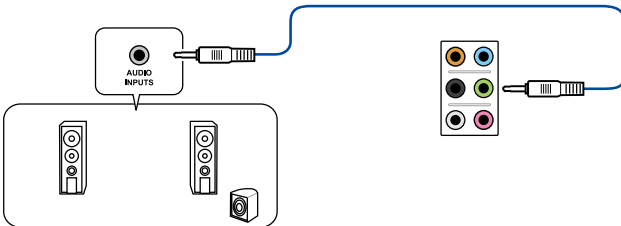

## Connect to 4.1 channel Speakers

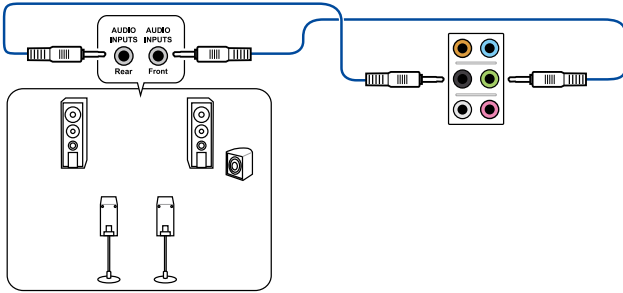

## Connect to 5.1 channel Speakers

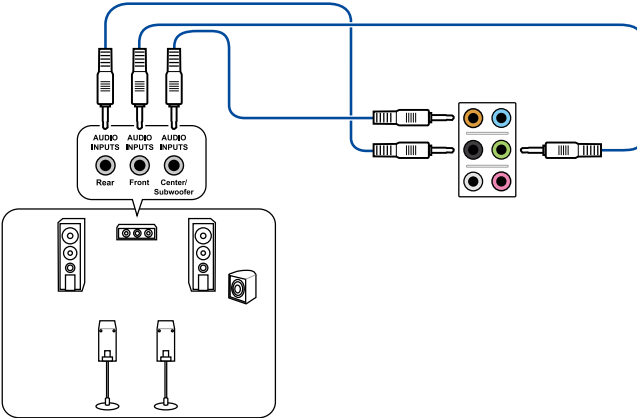

## Connect to 7.1 channel Speakers

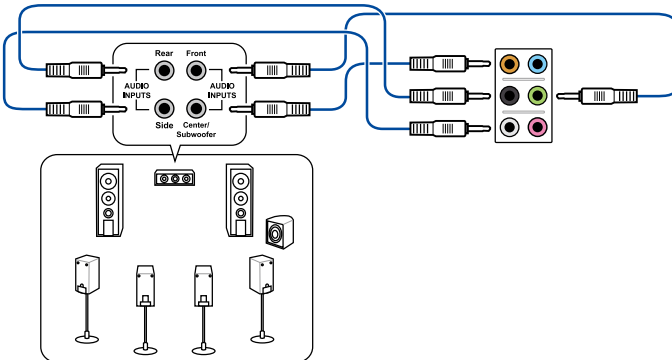

When the DTS UltraPC II function is enabled, ensure to connect the rear speaker to the gray port.

## 2.4 Starting up for the first time

1. After making all the connections, replace the system case cover.
2. Be sure that all switches are off.
3. Connect the power cord to the power connector at the back of the system chassis.
4. Connect the power cord to a power outlet that is equipped with a surge protector.
5. Turn on the devices in the following order:
  - a. Monitor
  - b. External SCSI devices (starting with the last device on the chain)
  - c. System power
6. After applying power, the system power LED on the system front panel case lights up. For systems with ATX power supplies, the system LED lights up when you press the ATX power button. If your monitor complies with the “green” standards or if it has a “power standby” feature, the monitor LED may light up or change from orange to green after the system LED turns on.

The system then runs the power-on self tests or POST. While the tests are running, the BIOS beeps (refer to the BIOS beep codes table below) or additional messages appear on the screen. If you do not see anything within 30 seconds from the time you turned on the power, the system may have failed a power-on test. Check the jumper settings and connections or call your retailer for assistance.

BIOS Beep	Description
One short beep	VGA detected Quick boot set to disabled No keyboard detected
One continuous beep followed by two short beeps then a pause (repeated)	No memory detected
One continuous beep followed by three short beeps	No VGA detected
One continuous beep followed by four short beeps	Hardware component failure

7. At power on, hold down the <Delete> key to enter the BIOS Setup. Follow the instructions in Chapter 3.

## 2.5 Turning off the computer

While the system is ON, pressing the power switch for less than four seconds puts the system on sleep mode or soft-off mode, depending on the BIOS setting. Pressing the power switch for more than four seconds lets the system enter the soft-off mode regardless of the BIOS setting.



# Chapter 3

## 3.1 Knowing BIOS



The new ASUS UEFI BIOS is a Unified Extensible Interface that complies with UEFI architecture, offering a user-friendly interface that goes beyond the traditional keyboard-only BIOS controls to enable a more flexible and convenient mouse input. Users can easily navigate the new UEFI BIOS with the same smoothness as their operating system. The term "BIOS" in this user manual refers to "UEFI BIOS" unless otherwise specified.

BIOS (Basic Input and Output System) stores system hardware settings such as storage device configuration, overclocking settings, advanced power management, and boot device configuration that are needed for system startup in the motherboard CMOS. In normal circumstances, the default BIOS settings apply to most conditions to ensure optimum performance. **We recommend that you not change the default BIOS settings** except in the following circumstances:

- An error message appears on the screen during the system bootup and requests you to run the BIOS Setup.
- You have installed a new system component that requires further BIOS settings or update.



Inappropriate settings of the BIOS may result to instability or failure to boot. **We strongly recommend that you change the BIOS settings only with the help of a trained service personnel.**

## 3.2 BIOS setup program

A BIOS setup program is provided for BIOS item modification. When you start up the computer, the system provides you with the opportunity to run this program. Press <Del> during the Power-On Self-Test (POST) to enter the Setup utility. Otherwise, POST continues with its test routines.

If you wish to enter Setup after POST, press <Ctrl> + <Alt> + <Delete>, or press the reset button on the system chassis to restart the system. You can also turn the system off and then turn it back on to restart the system. Do this last option only if the first two failed.



- The BIOS setup screens shown in this section are for reference purposes only, and may not exactly match what you see on your screen.
- Ensure that a USB mouse is connected to your motherboard if you want to use the mouse to control the BIOS setup program.
- If the system becomes unstable after changing any BIOS setting, load the default settings to ensure system compatibility and stability. Select the **Load Optimized Defaults** item under the **Exit** menu. See section **3.9 Exit Menu** for details.
- If the system fails to boot after changing any BIOS setting, try to clear the CMOS and reset the motherboard to the default value. See section **2.2.5 Onboard switches** for information on how to erase the RTC RAM.
- The BIOS setup program does not support the bluetooth devices.

The BIOS setup program is designed to make it as easy to use as possible. Being a menu-driven program, it lets you scroll through the various submenus and select from the available options using a keyboard or a USB mouse.

The BIOS setup program can be used under two modes: **EZ Mode** and **Advanced Mode**. You can change modes from the **Exit** menu or from the **Exit/Advanced Mode** button in the **EZ Mode/Advanced Mode** screen.

### 3.2.1 EZ Mode

By default, the EZ Mode screen appears when you enter the BIOS setup program. The EZ Mode provides you an overview of the basic system information, and allows you to select the display language, system performance mode and boot device priority. To access the Advanced Mode, click **Exit/Advanced Mode**, then select **Advanced Mode** or press F7 hot key for the advanced BIOS settings.



The default screen for entering the BIOS setup program can be changed. Refer to the **Setup Mode** item in section 3.7 **Boot menu** for details.

The screenshot shows the ASUS UEFI BIOS Utility - EZ Mode interface. The top left displays the time '03:11' and date 'Sunday 09/15/2009'. The top right shows the language set to 'English' and a button for 'Exit/Advanced Mode'. The main area is divided into several sections: 'Temperature' with CPU and MB gauges; 'Voltage' with CPU and VBAT gauges; 'Fan Speed' with CPU FAN, CPU OPT. FAN, and CH. FAN1 gauges; 'System Performance' with 'Quiet', 'Performance', and 'Energy Saving' modes; and 'Boot Priority' with 'Storage (F8)' and 'Advanced Mode (F7)' options. At the bottom, there are buttons for 'Boot Menu (F8)' and 'Default (F5)'. Red callouts point to various features: 'Selects the display language of the BIOS setup program' points to the language dropdown; 'Clicks to display all fan speeds if available' points to the Fan Speed section; 'Displays the CPU/motherboard temperature, CPU/5V/3.3V/12V voltage output, CPU/chassis/power fan speed' points to the Temperature and Voltage sections; 'Exits the BIOS setup program without saving the changes, saves the changes and resets the system, or enters the Advanced Mode' points to the Exit/Advanced Mode button; 'Selects the boot device priority' points to the Boot Priority section; 'Displays the Advanced mode menus' points to the Performance and Energy Saving modes; 'Power Saving mode' points to the Quiet mode; 'Normal mode' points to the Performance mode; 'ASUS Optimal mode' points to the Energy Saving mode; 'Loads optimized default' points to the Default (F5) button; 'Displays the system properties of the selected mode on the right hand side' points to the mode selection area; and 'Selects the Advanced mode functions' points to the Advanced Mode (F7) button.



- The boot device options vary depending on the devices you installed to the system.
- The **Boot Menu(F8)** button is available only when the boot device is installed to the system.



### 3.2.2 Advanced Mode

The Advanced Mode provides advanced options for experienced end-users to configure the BIOS settings. The figure below shows an example of the Advanced Mode. Refer to the following sections for the detailed configurations.



To access the Advanced Mode, click **Exit**, then select **Advanced Mode** or press **F7** hotkey.

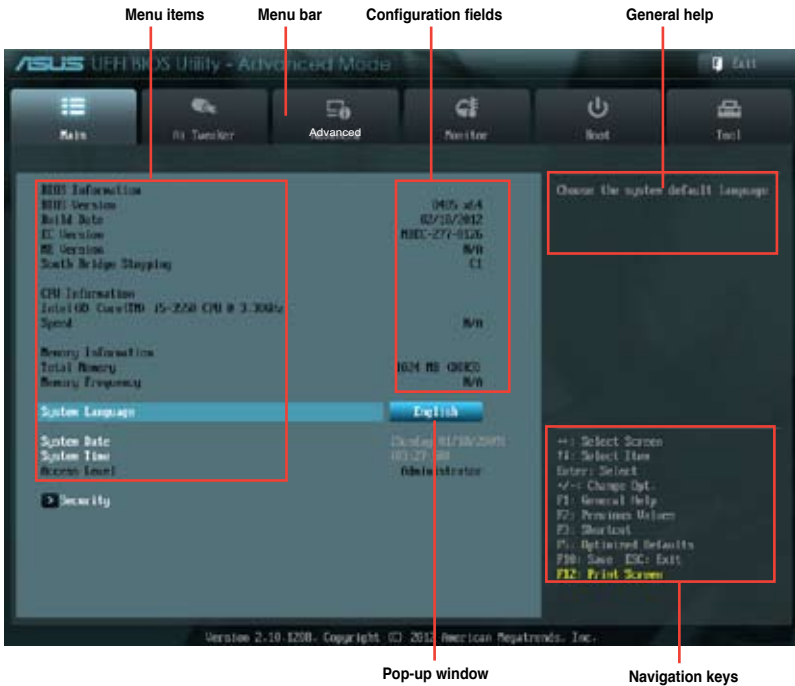

#### Menu bar

The menu bar on top of the screen has the following main items:

<b>Main</b>	For changing the basic system configuration
<b>Ai Tweaker</b>	For changing the overclocking settings
<b>Advanced</b>	For changing the advanced system settings
<b>Monitor</b>	For displaying the system temperature, power status, and changing the fan settings.
<b>Boot</b>	For changing the system boot configuration
<b>Tool</b>	For configuring options for special functions
<b>Exit</b>	For selecting the exit options and loading default settings

## Menu items

The highlighted item on the menu bar displays the specific items for that menu. For example, selecting **Main** shows the Main menu items.

The other items (Ai Tweaker, Advanced, Monitor, Boot, Tool, and Exit) on the menu bar have their respective menu items.

## Back button

This button appears when entering a submenu. Press <Esc> or use the USB mouse to click this button to return to the previous menu screen.

## Submenu items

A greater than sign (>) before each item on any menu screen means that the item has a submenu. To display the submenu, select the item and press <Enter>.

## Pop-up window

Select a menu item and press <Enter> to display a pop-up window with the configuration options for that item.

## Scroll bar

A scroll bar appears on the right side of a menu screen when there are items that do not fit on the screen. Press the Up/Down arrow keys or <Page Up> / <Page Down> keys to display the other items on the screen.

## Navigation keys

At the bottom right corner of the menu screen are the navigation keys for the BIOS setup program. Use the navigation keys to select items in the menu and change the settings.

## General help

At the top right corner of the menu screen is a brief description of the selected item. Use <F12> key to capture the BIOS screen and save it to the removable storage device.

## Configuration fields

These fields show the values for the menu items. If an item is user-configurable, you can change the value of the field opposite the item. You cannot select an item that is not user-configurable.

A configurable field is highlighted when selected. To change the value of a field, select it and press <Enter> to display a list of options.

## 3.3 Main menu

The Main menu screen appears when you enter the Advanced Mode of the BIOS Setup program. The Main menu provides you an overview of the basic system information, and allows you to set the system date, time, language, and security settings.



### 3.3.1 System Language [English]

Allows you to choose the BIOS language version from the options. Configuration options:

[English] [Français] [Español] [Deutsch] [Русский] [日本語] [简体中文] [繁體中文]

### 3.3.2 System Date [Day xx/xx/xxxx]

Allows you to set the system date.

### 3.3.3 System Time [xx:xx:xx]

Allows you to set the system time.

### 3.3.4 Security

The Security menu items allow you to change the system security settings.



- If you have forgotten your BIOS password, erase the CMOS Real Time Clock (RTC) RAM to clear the BIOS password. See section **2.3.5 Onboard switches** for information on how to erase the RTC RAM.
- The **Administrator** or **User Password** items on top of the screen show the default **Not Installed**. After you set a password, these items show **Installed**.

### Administrator Password

If you have set an administrator password, we recommend that you enter the administrator password for accessing the system. Otherwise, you might be able to see or change only selected fields in the BIOS setup program.

To set an administrator password:

1. Select the **Administrator Password** item and press <Enter>.
2. From the **Create New Password** box, key in a password, then press <Enter>.
3. Confirm the password when prompted.

To change an administrator password:

1. Select the **Administrator Password** item and press <Enter>.
2. From the **Enter Current Password** box, key in the current password, then press <Enter>.
3. From the **Create New Password** box, key in a new password, then press <Enter>.
4. Confirm the password when prompted.

To clear the administrator password, follow the same steps as in changing an administrator password, but press <Enter> when prompted to create/confirm the password. After you clear the password, the **Administrator Password** item on top of the screen shows **Not Installed**.

## User Password

If you have set a user password, you must enter the user password for accessing the system. The **User Password** item on top of the screen shows the default **Not Installed**. After you set a password, this item shows **Installed**.

To set a user password:

1. Select the **User Password** item and press <Enter>.
2. From the **Create New Password** box, key in a password, then press <Enter>.
3. Confirm the password when prompted.

To change a user password:

1. Select the **User Password** item and press <Enter>.
2. From the **Enter Current Password** box, key in the current password, then press <Enter>.
3. From the **Create New Password** box, key in a new password, then press <Enter>.
4. Confirm the password when prompted.

To clear the user password, follow the same steps as in changing a user password, but press <Enter> when prompted to create/confirm the password. After you clear the password, the **User Password** item on top of the screen shows **Not Installed**.

### 3.4 Ai Tweaker menu

The Ai Tweaker menu items allow you to configure overclocking-related items.



Be cautious when changing the settings of the Ai Tweaker menu items. Incorrect field values can cause the system to malfunction.



The configuration options for this section vary depending on the CPU and DIMM model you installed on the motherboard.



Scroll down to display the following items:



## Ai Overclock Tuner [Auto]

Allows you to select the CPU overclocking options to achieve the desired CPU internal frequency. Select any of these preset overclocking configuration options:

- [Auto] Loads the optimal settings for the system.
- [Manual] Allows you to individually set overclocking parameters.
- [X.M.P.] If you install memory modules supporting the eXtreme Memory Profile (X.M.P.) Technology, choose this item to set the profiles supported by your memory modules for optimizing the system performance.



---

The item X.M.P. appears only when you set the Ai Overclocking Tuner to [Manual].

---

## Turbo Ratio [Auto]

Allows you to set the CPU ratio automatically or manually.

- [Auto] Sets all Turbo Ratio to Intel® CPU default settings automatically.
- [Manual] Sets the Turbo Ratio for every core-activation condition of a full unlocked CPU manually.



---

When the Turbo Ratio is set to [Manual], the following item appears:

---

### Ratio Synchronizing Control [Disable]

- [Enabled] Allows you to set an individual Turbo Ratio for every core-activation condition
- [Disabled] Allows you to set one single Turbo Ratio for all core-activation conditions.

### 1-Core Ratio Limit [Auto]

Allows you to set the 1-Core Ratio Limit

- [Auto] Select to apply the CPU default Turbo Ratio setting
- [35~63] Select to manually assign a 1-Core Ratio Limit value that is higher than or equal to the 2-Core Ratio Limit.

### 2-Core Ratio Limit [Auto]

Allows you to set the 2-Core Ratio Limit

- [Auto] Select to apply the CPU default Turbo Ratio setting
- [35~63] Select to manually assign a 2-Core Ratio Limit value that is higher than or equal to the 3-Core Ratio Limit. 1-Core Limit must not be set to [Auto]

### 3-Core Ratio Limit [Auto]

Allows you to set the 3-Core Ratio Limit

- [Auto] Select to apply the CPU default Turbo Ratio setting
- [35~63] Select to manually assign a 3-Core Ratio Limit value that is higher than or equal to the 4-Core Ratio Limit. 1-Core/2-Core Ratio Limit must not be set to [Auto]

### 4-Core Ratio Limit [Auto]

Allows you to set the 4 Core Ratio Limit

- [Auto] Select to apply the CPU default Turbo Ratio setting
- [35~63] Select to manually assign a 4-Core Ratio Limit value that is higher than or equal to the 3-Core Ratio Limit. 1-Core/2-Core/3-Core Limit must not be set to [Auto]

## Internal PLL Overvoltage [Auto]

Allows you to set the internal PLL voltage.

Configuration options: [Auto] [Enabled] [Disabled]

## CPU bus speed : DRAM speed ratio mode [Auto]

Allows you to set the CPU bus speed to DRAM speed ratio mode.

[Auto] DRAM speed is set to the optimized settings.

[100:133] The CPU bus speed to DRAM speed ratio is set to 100:133.

[100:100] The CPU bus speed to DRAM speed ratio is set to 100:100.

## Memory Frequency [Auto]

Allows you to set the memory operating frequency. The configuration options vary with the **BCLK/PCIE Frequency** item settings. Configuration options: [Auto]

[DDR3-800MHz] [DDR3-1066MHz] [DDR3-1333MHz] [DDR3-1400MHz] [DDR3-1600MHz]

[DDR3-1800MHz] [DDR3-1866MHz] [DDR3-2000MHz] [DDR3-2133MHz] [DDR3-2200MHz]

[DDR3-2400MHz] [DDR3-2600MHz] [DDR3-2660MHz] [DDR3-2800MHz]



---

Selecting a very high memory frequency may cause the system to become unstable! If this happens, revert to the default setting.

---

## EPU Power Saving Mode [Disabled]

Allows you to enable or disable the EPU power saving function.

Configuration options: [Disabled] [Enabled]

## OC Tuner

OC Tuner automatically overclocks the frequency and voltage of CPU and DRAM for enhancing the system performance. Configuration options: [OK] [Cancel]



## DRAM Timing Control

The sub-items in this menu allow you to set the DRAM timing control features. Use the <+> and <-> keys to adjust the value. To restore the default setting, type [auto] using the keyboard and press the <Enter> key.



Changing the values in this menu may cause the system to become unstable! If this happens, revert to the default settings. **Primary Timings**



Scroll down to display the following items:



Scroll down to display the following items:



### Primary Timings

#### DRAM CAS# Latency [Auto]

Configuration options: [Auto] [1 DRAM Clock] – [15 DRAM Clock]

#### DRAM RAS# to CAS# Delay [Auto]

Configuration options: [Auto] [1 DRAM Clock] – [15 DRAM Clock]

#### DRAM RAS# PRE Time [Auto]

Configuration options: [Auto] [1 DRAM Clock] – [15 DRAM Clock]

#### DRAM RAS# ACT Time [Auto]

Configuration options: [Auto] [1 DRAM Clock] – [255 DRAM Clock]

#### DRAM COMMAND Mode [Auto]

Configuration options: [Auto] [1 DRAM Clock] [2 DRAM Clock] [3 DRAM Clock]

### Secondary Timings

#### DRAM RAS# to RAS# Delay [Auto]

Configuration options: [Auto] [1 DRAM Clock] – [15 DRAM Clock]

#### DRAM REF Cycle Time [Auto]

Configuration options: [Auto] [1 DRAM Clock] – [511 DRAM Clock]

#### DRAM Refresh Interval [Auto]

Configuration options: [Auto] [1 DRAM Clock] – [65535 DRAM Clock]

#### DRAM WRITE Recovery Time [Auto]

Configuration options: [Auto] [1 DRAM Clock] – [31 DRAM Clock]

*DRAM READ to PRE Time [Auto]*

Configuration options: [Auto] [1 DRAM Clock] – [15 DRAM Clock]

*DRAM FOUR ACT WIN Time [Auto]*

Configuration options: [Auto] [1 DRAM Clock] – [63 DRAM Clock]

*DRAM WRITE to READ Delay [Auto]*

Configuration options: [Auto] [1 DRAM Clock] – [15 DRAM Clock]

*DRAM CKE Minimum pulse width [Auto]*

Configuration options: [Auto] [1 DRAM Clock] – [15 DRAM Clock]

*DRAM CAS# Write Latency [Auto]*

Configuration options: [Auto] [1 DRAM Clock] – [15 DRAM Clock]

*DRAM RTL (CHA) [Auto]*

Configuration options: [Auto] [1 DRAM Clock] – [63 DRAM Clock]

*DRAM RTL (CHB) [Auto]*

Configuration options: [Auto] [1 DRAM Clock] – [63 DRAM Clock]

*DRAM IO-L (CHA) [Auto]*

Configuration options: [Auto] [Delay 1 Clock] – [Delay 15 Clock]

*DRAM IO-L (CHB) [Auto]*

Configuration options: [Auto] [Delay 1 Clock] – [Delay 15 Clock]

**Third Timings***tWRDR (DD) [Auto]*

Configuration options: [Auto] [1 DRAM Clock] – [8 DRAM Clock]

*tRWDR (DD) [Auto]*

Configuration options: [Auto] [1 DRAM Clock] – [8 DRAM Clock]

*tRWSR [Auto]*

Configuration options: [Auto] [1 DRAM Clock] – [8 DRAM Clock]

*tRR (DD) [Auto]*

Configuration options: [Auto] [1 DRAM Clock] – [8 DRAM Clock]

*tRR (DR) [Auto]*

Configuration options: [Auto] [1 DRAM Clock] – [8 DRAM Clock]

*tRRSR [Auto]*

Configuration options: [Auto] [4 DRAM Clock] – [7 DRAM Clock]

*tWW (DD) [Auto]*

Configuration options: [Auto] [1 DRAM Clock] – [8 DRAM Clock]

*tWW (DR) [Auto]*

Configuration options: [Auto] [1 DRAM Clock] – [8 DRAM Clock]

*tWWSR [Auto]*

Configuration options: [Auto] [4 DRAM Clock] – [7 DRAM Clock]

**MISC**MRC Fast Boot [Enabled]

Configuration options: [Enabled] [Disabled]

DRAM CLK Period [Auto]

Configuration options: [Auto] [1] – [14]

Transmitter Slew (CHA) [Auto]

Configuration options: [Auto] [1] – [7]

Transmitter Slew (CHB) [Auto]

Configuration options: [Auto] [1] – [7]

Receiver Slew (CHA) [Auto]

Configuration options: [Auto] [1] – [7]

Receiver Slew (CHB) [Auto]

Configuration options: [Auto] [1] – [7]

MCH Duty Sense (CHA) [Auto]

Configuration options: [Auto] [1] – [31]

MCH Duty Sense (CHB) [Auto]

Configuration options: [Auto] [1] – [31]

Channel A DIMM Control [Enable Both DIMMS]

Configuration options: [Enable Both DIMMS] [Disable DIMM0] [Disable DIMM1] [Disable Both DIMMS]

Channel B DIMM Control [Enable Both DIMMS]

Configuration options: [Enable Both DIMMS] [Disable DIMM0] [Disable DIMM1] [Disable Both DIMMS]

DRAM Read Additional Swizzle [Auto]

Configuration options: [Auto] [Enabled] [Disabled]

DRAM Write Additional Swizzle [Auto]

Configuration options: [Auto] [Enabled] [Disabled]

**CPU Power Management**

The sub-items in this menu allow you to set the CPU ratio and features.

CPU Ratio [Auto]

Allows you to manually adjust the maximum non-turbo CPU ratio. Use <+> and <-> keys to adjust the value. The valid value ranges vary according to your CPU model.

Enhanced Intel SpeedStep Technology [Enabled]

Allows you to enable or disable the Enhanced Intel® SpeedStep Technology (EIST).

[Disabled] Disables this function.

[Enabled] The operating system dynamically adjusts the processor voltage and core frequency which may result in decreased average consumption and decreased average heat production.

### Turbo Mode [Enabled]

Allows you to enable your core processor's speed to run faster than the marked frequency in a specific condition. Configuration options: [Disabled] [Enabled]



The following three items appears only when you set the Turbo Mode to **[Enabled]**.

#### **Long Duration Power Limit [Auto]**

Allows you to limit the turbo ratio's long duration power.  
Use the <+> and <-> keys to adjust the value.

#### **Long Duration Maintained [Auto]**

Allows you to maintain the turbo ratio's long duration power.  
Use the <+> and <-> keys to adjust the value.

#### **Short Duration Power Limit [Auto]**

Allows you to limit the turbo ratio's long duration power.  
Use the <+> and <-> keys to adjust the value.

#### **Primary Plane Current Limit [Auto]**

Maximum instantaneous current allowed at any given time for CPU cores  
Use <+> and <-> key to adjust the value at 0.125A increment. .

#### **Secondary Plane Current Limit [Auto]**

Maximum instantaneous current allowed at any given time for Internal Graphics cores.  
Use <+> and <-> key to adjust the value at 0.125A increment.

## **DIGI+ Power Control**



Do not remove the thermal module while changing the DIGI+ Power Control related parameters . The thermal conditions should be monitored.



Some of the following items are adjusted by typing the desired values using the numeric keypad and press the <Enter> key. You can also use the <+> and <-> keys to adjust the value. To restore the default setting, type [auto] using the keyboard and press the <Enter> key.

### CPU Load-Line Calibration [Auto]

CPU Load-line is defined by Intel VRM spec and affects CPU voltage. The CPU working voltage will decrease proportionally to CPU loading. Higher load-line calibration would get higher voltage and better overclocking performance, but increase the CPU and VRM thermal. This item allows you to adjust the voltage range from the following percentages to boost the system performance: 0% (Regular), 25% (Medium), 50% (High), 75% (Ultra High) and 100% (Extreme).

Configuration options: [Auto] [Regular] [Medium] [High] [Ultra High] [Extreme]



The actual performance boost may vary depending on your CPU specification.

### CPU Voltage Frequency [Auto]

Frequency switching affects the VRM transient response, and the thermal component. Higher frequency gets quicker transient response.

Configuration options: [Auto] [Manual]



---

DO NOT remove the thermal module when switching to Manual Mode. The thermal conditions should be monitored.

---

#### VRM Spread Spectrum [Disabled]

This item appears only when you set the **Frequency** item to **[Auto]** and allows you to enable the spread spectrum to enhance system stability.

#### CPU Power Phase Control [Auto]

Phase number is the number of working VRM phase. Increasing phase number under heavy system loading to get more transient and better thermal performance. Reducing phase number under light system loading to increase VRM efficiency

[Auto]	The default power control phase mode
[Standard]	Proceeds phase control depending on the CPU loading.
[Optimized]	Loads the ASUS optimized phase tuning profile.
[Extreme]	Proceeds the full phase mode.
[Manual Adjustment]	Allows manual adjustment.

#### CPU Power Duty Control [T.Probe]

[T.Probe] Maintains the VRM thermal balance.

[Extreme] Maintains the VRM current balance.

#### CPU Current Capability [100%]

Allows you to configure the total power range, and extends the overclocking frequency range simultaneously.

Configuration options: [100%] [110%] [120%] [130%] [140%]

---



Choose a higher value when overclocking, or under a high CPU loading for extra power support.

---

#### CPU Power Thermal Control [130]

A higher temperature brings a wider CPU power thermal range and extends the overclocking tolerance to enlarge the O.C. potential. Use the <+> and <-> keys to adjust the value. The values range from 130 to 151.

---



DO NOT remove the thermal module. The thermal conditions should be monitored.

---

#### CPU Power Response Control [Auto]

The DIG+ VRM controller provides a faster, and precise power response rate for the CPU. Apply a higher value for an extreme overclocking.

Configuration options: [Auto] [Regular] [Medium] [Fast] [Ultra Fast]

---



The actual performance boost may vary depending on your CPU configuration.

---

#### iGPU Load-line Calibration [Auto]

Allows you to set the iGPU Load-line Calibration.

Configuration options: [Auto] [Regular] [High] [Extreme]

---

#### iGPU Current Capability [100%]

Allows you to set the iGPU Current Capability.

Configuration options: [100%] [110%] [120%] [130%] [140%]

---



DO NOT remove the thermal module while changing the DIG+ VRM related parameters . The thermal conditions should be monitored.

---

**DRAM Current Capability [100%]**

Setting a higher value brings a wider total power range and extends the overclocking frequency range simultaneously.

Configuration options: [100%] [110%] [120%] [130%]

**DRAM Voltage Frequency [Auto]**

This item allows you to adjust the DRAM switching frequency. Assign a fixed high DRAM frequency to increase O.C range or a lower DRAM frequency for better system stability.

Configuration options: [Auto] [manual]

**DRAM Power Phase control [Auto]**

[Auto] Allows you to set the default DRAM power phase control settings.

[Optimized] Allows you to set ASUS optimized phase tuning profile.

[Extreme] Allows you to set the Full phase mode.

**DRAM Power Thermal Control [110]**

A higher temperature brings a wider DRAM power thermal range, and extends the overclocking tolerance to enlarge the O.C. potential. Use the <+> and <-> keys to adjust the value. The values range from 110 to 131.



DO NOT remove the thermal module. The thermal conditions must be monitored.

**CPU Voltage [Offset Mode]**

[Manual Mode] Allows you to set a fixed CPU voltage.

[Offset Mode] Allows you to set the Offset voltage.

**Offset Mode Sign [+]**

This item appears only when you set the **CPU Voltage** item to [Offset Mode].

[+] To offset the voltage by a positive value.

[-] To offset the voltage by a negative value.

**CPU Offset Voltage [Auto]**

This item appears only when you set the **CPU Voltage** item to [Offset Mode] and allows you to set the Offset voltage. The values range from 0.005V to 0.635V with a 0.005V interval.

**CPU Manual Voltage [Auto]**

This item appears only when you set the **CPU Voltage** item to [Manual Mode] and allows you to set a fixed CPU voltage. The values range from 0.800V to 1.990V with a 0.005V interval.



Refer to the CPU documentation before setting the CPU voltage. Setting a high voltage may damage the CPU permanently, and setting a low voltage may make the system unstable.

**DRAM Voltage [Auto]**

Allows you to set the DRAM voltage. The values range from 1.20V to 1.99V with a 0.005V interval. The 1.92V voltage is available only when the Extreme OV item is set to [Enabled].



---

According to Intel CPU spec, DIMMs with voltage requirement over 1.65V may damage the CPU permanently. We recommend you install the DIMMs with the voltage requirement below 1.65V.

---

### **VCCSA Voltage [Auto]**

Allows you to set the VCCSA voltage. The values range from 0.80V to 1.70V with a 0.00625V interval.

### **VCCIO Voltage [Auto]**

Allows you to set the VCCIO voltage. The values range from 0.80V to 1.70V with a 0.00625V interval.

### **CPU PLL Voltage [Auto]**

Allows you to set the CPU PLL voltage. The values range from 1.20V to 2.20V with a 0.00625V interval.

### **PCH Voltage [Auto]**

Allows you to set the Platform Controller Hub voltage. The values range from 0.8000V to 1.7000 with a 0.01V interval.



- The values of the CPU Manual Voltage, CPU Offset Voltage, iGPU Manual Voltage, iGPU Offset Voltage, DRAM Voltage, VCCIO Voltage, and PCH Voltage items are labeled in different color, indicating the risk levels of high voltage settings.
  - The system may need better cooling system to work stably under high voltage settings.
- 

### **DRAM DATA REF Voltage on CHA/B [Auto]**

Allows you to set the DRAM DATA Reference Voltage on Channel A/B. The values range from 0.395x to 0.630x with a 0.005x interval. Different ratio might enhance DRAM overlocking ability.

### **DRAM CTRL REF Voltage on CHA/B [Auto]**

Allows you to set the DRAM Control Reference Voltage on Channel A/B. The values range from 0.395x to 0.630x with a 0.005x interval. Different ratio might enhance DRAM overlocking ability.

### **CPU Spread Spectrum [Auto]**

- |            |  |
|------------|--|
| [Auto]     | Automatic configuration.               |
| [Disabled] | Enhances the BCLK overlocking ability. |
| [Enabled]  | Sets to [Enabled] for EMI control.     |



## 3.5 Advanced menu

The Advanced menu items allow you to change the settings for the CPU and other system devices.



Be cautious when changing the settings of the Advanced menu items. Incorrect field values can cause the system to malfunction.



### 3.5.1 CPU Configuration

The items in this menu show the CPU-related information that the BIOS automatically detects.



The items shown in this screen may be different due to the CPU you installed.



Scroll down to display the following items:



#### Intel Adaptive Thermal Monitor [Enabled]

- [Enabled] Enables the overheated CPU to throttle its clock speed to cool down.
- [Disabled] Disables the CPU thermal monitor function.

#### Active Processor Cores [All]

Allows you to choose the number of CPU cores to activate in each processor package. Configuration options: [All] [1] [2] [3]

#### Limit CPUID Maximum [Disabled]

- [Enabled] Allows legacy operating systems to boot even without support for CPUs with extended CPUID functions.
- [Disabled] Disables this function.

**Execute Disable Bit [Enabled]**

[Enabled] Enables the No-Execution Page Protection Technology.

[Disabled] Forces the XD feature flag to always return to zero (0).

**Intel® Virtualization Technology [Disabled]**

[Enabled] Allows a hardware platform to run multiple operating systems separately and simultaneously, enabling one system to virtually function as several systems.

[Disabled] Disables this function.

**Hardware Prefetcher [Enabled]**

[Enabled] Allows a hardware platform to run multiple operating systems separately and simultaneously, enabling one system to virtually function as several systems.

[Disabled] Disables this function.

**Adjacent Cache Line Prefetch [Enabled]**

[Enabled] Allows a hardware platform to perform adjacent cache line prefetching.

[Disabled] Disables this function.

**CPU Power Management Configuration**

This item allows you to manage and configure the CPU's power.

***CPU Ratio [Auto]***

Allows you to set the ratio between the CPU Core Clock and the BCLK Frequency. Use <+> and <-> keys to adjust the ratio. The valid value ranges vary according to your CPU model.

***Enhanced Intel SpeedStep Technology [Enabled]***

Allows you to enable or disable the Enhanced Intel® SpeedStep Technology (EIST).

[Disabled] The CPU runs at its default speed.

[Enabled] The operating system controls the CPU speed.

***Turbo Mode [Enabled]***

Allows you to set the processor cores to run faster than the marked frequency in a specific condition.

Configuration options: [Enabled] [Disabled]

***CPU C1E [Auto]***

[Auto] Set this item automatically.

[Enabled] Enables the C1E support function. This function must be enabled to enable or disable the Intel® Turbo Mode Technology.

[Disabled] Disables the function.

***CPU C3 Report [Auto]***

Allows you to disable or enable the CPU C3 report to OS.

[Auto] Set this item automatically.

[Enabled] Enables the C3 Report support function.

[Disabled] Disables the function.

### CPU C6 Report [Auto]

Allows you to disable or enable the CPU C6 report to OS.

[Auto] Set this item automatically.

[Enabled] Enables the C6 Report support function.

[Disabled] Disables the function.

## 3.5.2 PCH Configuration



### **High Precision Timer [Enabled]**

Allows you to enable or disable the High Precision Event Timer.

Configuration options: [Enabled] [Disabled]

### **Intel(R) Rapid Start Technology**

#### **Intel(R) Rapid Start Technology [Disabled]**

Allows you to enable or disable the Intel(R) Rapid Start Technology.

Configuration options: [Enabled] [Disabled]



The following three items appear only when you set the **Intel(R) Rapid Start Technology** to [Enabled].

### Entry on S3 RTC Wake [Enabled]

Allows you to enable or disable the iFFS invocation upon S3 RTC wake.

Configuration options: [Enabled] [Disabled]

### Entry After [10 Minutes]

This item appears only when you set the **Entry on S3 RTC Wake** to [Enabled] and allows you to set the RTC wake timer at S3 entry.

Configuration options: [Immediately] [1 minute] [2 minute] [5 minute] [10 minute] [15 minute] [30 minute] [1 hour] [2 hours]

### Active Page Threshold Support [Disabled]

Allows you to enable or disable the Active Page Threshold Support.

Configuration options: [Enabled] [Disabled]

### Active Memory Threshold [x]

This item appears only when you set the **Active Page Threshold Support** to [Enabled] and allows you to set the Active Memory Threshold. When the partition size is larger than the Active Page Threshold size, the system will try to support the Intel(R) Rapid Start Technology. When the item is set to zero, the system automatically checks whether the partition size is enough at S3 entry. Key in the desired value using the numeric keypad.

## Intel(R) Smart Connect Technology

### **ISCT Configuration [Disabled]**

Allows you to enable or disable the ISCT configuration.

Configuration options: [Enabled] [Disabled]

### 3.5.3 SATA Configuration

While entering Setup, the BIOS automatically detects the presence of SATA devices. The SATA Port items show **Not Present** if no SATA device is installed to the corresponding SATA port.



Scroll down to display the following items:



#### SATA Mode Selection [AHCI]

Allows you to set the SATA configuration.

- [IDE] Set to [IDE Mode] when you want to use the Serial ATA hard disk drives as Parallel ATA physical storage devices.
- [AHCI] Set to [AHCI Mode] when you want the SATA hard disk drives to use the AHCI (Advanced Host Controller Interface). The AHCI allows the onboard storage driver to enable advanced Serial ATA features that increases storage performance on random workloads by allowing the drive to internally optimize the order of commands.
- [RAID] Set to [RAID Mode] when you want to create a RAID configuration from the SATA hard disk drives.

## S.M.A.R.T. Status Check [Enabled]

S.M.A.R.T. (Self-Monitoring, Analysis and Reporting Technology) is a monitor system. When read/write of your hard disk errors occur, this feature allows the hard disk to report warning messages during the POST.

Configuration options: [Enabled] [Disabled]

## Hot Plug [Disabled]

These items appear only when you set the **SATA Mode Selection** item to [AHCI] or [RAID], and allow you to enable/disable SATA Hot Plug Support.

Configuration options: [Disabled] [Enabled]

### 3.5.4 System Agent Configuration



## Memory Remap Feature [Enabled]

Allows you to enable remapping the memory above 4GB.

[Enabled] Enables the function.

[Disabled] Disables this function.

## Graphics Configuration [Auto]

Allows you to select a primary display from iGPU, and PCIe graphical devices.

### Primary Display [Auto]

Allows you to select which of the iGPU/PEG Graphics device should be the Primary Display.

Configuration options: [Auto] [iGPU] [PCIe]

### iGPU Memory [64M]

Allows you to select the amount of system memory allocated to DVMT 5.0 used by the iGPU. Configuration options: [32M] [64M] [96M] [128M] ~ [448M] [480M] [512M]

### Render Standby [Enabled]

Allows you to enable the Intel Graphics Render Standby support to reduce the iGPU power use when idle. Configuration options: [Disabled] [Enabled]

### iGPU Multi-Monitor [Disabled]

Allows you to enable the iGPU Multi-Monitor. For Lucid Virtu MVP function supports, set this item to [Enabled] to empower both integrated and discrete graphics. iGPU shared system memory size is fixed in 64MB.

Configuration options: [Disabled] [Enabled]

### 3.5.5 USB Configuration

The items in this menu allow you to change the USB-related features.



The **USB Devices** item shows the auto-detected values. If no USB device is detected, the item shows **None**.

#### Legacy USB Support [Enabled]

- [Enabled] Enables the support for USB devices on legacy operating systems (OS).
- [Disabled] The USB devices can be used only for the BIOS setup program.
- [Auto] Allows the system to detect the presence of USB devices at startup. If detected, the USB controller legacy mode is enabled. If no USB device is detected, the legacy USB support is disabled.

#### Legacy USB3.0 Support [Enabled]

This item appears only when you set the previous item to [Auto] or [Enabled] and allows you to enable or disable the Legacy USB 3.0 Support.

- [Enabled] Enables the support for USB 3.0 devices on legacy operating systems (OS).
- [Disabled] Disables the function.

#### Intel xHCI Mode [Smart Auto]

Allows you to select the Intel xHCI Mode.

Configuration options: [Smart Auto] [Auto] [Enabled] [Disabled]

#### EHCI Hand-off [Disabled]

- [Enabled] Enables the support for operating systems without an EHCI hand-off feature.
- [Disabled] Disables the function.



### 3.5.6 Onboard Devices Configuration



Scroll down to display the following items:



#### HD Audio Controller [Enabled]

[Enabled] Enables the High Definition Audio Controller.

[Disabled] Disables the controller.



The following two items appear only when you set the **HD Audio Controller** item to [Enabled].

#### Front Panel Type [HD]

Allows you to set the front panel audio connector (AAFP) mode to legacy AC'97 or high-definition audio depending on the audio standard that the front panel audio module supports.

[HD] Sets the front panel audio connector (AAFP) mode to high definition audio.

[AC97] Sets the front panel audio connector (AAFP) mode to legacy AC'97

## **SPDIF Out Type [SPDIF]**

[SPDIF] Sets to [SPDIF] for SPDIF audio output.

[HDMI] Sets to [HDMI] for HDMI audio output.

## **VIA 1394 Controller [Enabled]**

[Enabled] Enables the onboard 1394 controller.

[Disabled] Disables the controller.

## **Marvell Storage Controller [Enabled]**

Allows you to select the Marvell storage controller operating mode.

[Disabled] Disables the controller.

[Enabled] Enables the controller.

## **Marvell Storage OPROM [Enabled]**

This item appears only when you set the previous item to [Enabled] and allows you to enable or disable the OptionRom of the Marvell storage controller.

Configuration options: [Enabled] [Disabled]

## **Marvell Storage Firmware Check And Update [Disabled]**

Configuration options: [Enabled] [Disabled]

## **ASM1061 Storage Controller (Rear) [Enabled]**

Allows you to select the ASM1061 storage controller operating mode.

[Disabled] Disables the controller.

[Enabled] Enables the controller.

## **ASM1061 Storage OPROM [Enabled]**

This item appears only when you set the previous item to [Enabled] and allows you to enable or disable the OptionRom of the ASM1061 storage controller.

Configuration options: [Enabled] [Disabled]

## **Intel LAN1/2 Controller [Enabled]**

[Enabled] Enables the Intel LAN controller.

[Disabled] Disables the controller.

## **Intel LAN1/2 OPROM [Disabled]**

This item appears only when you set the previous item to [Enabled] and allows you to enable or disable the PXE OptionRom of the Intel LAN controller.

Configuration options: [Enabled] [Disabled]

## **ASmedia USB 3.0 Controller (USB3\_E12) [Enabled]**

[Enabled] Enables the USB 3.0 controller.

[Disabled] Disables the controller.

## ASmedia USB 3.0 Battery Charging Support [Disabled]

This item appears only when you set the previous item to [Enabled] and allows you to enable or disable the ASmedia USB 3.0 Battery Charging Support.

- [Enabled] Enables Asmedia USB 3.0 fast battery charging support for USB 3.0 devices complying with the BC 1.1 regulation.
- [Disabled] Disables battery charging support.

## Serial Port Configuration

The sub-item in this menu allow you to set the serial port configuration.



This item functions only if there is a serial port (COM1) connector on the motherboard.

### Serial Port [Enabled]

Allows you to enable or disable the serial port (COM).

Configuration options: [Enabled][Disabled]

#### Change Settings [IO=3F8h; IRQ=4]

Allows you to select the Serial Port base address.

Configuration options: [IO=3F8h; IRQ=4][IO=2F8h; IRQ=3][IO=3E8h; IRQ=4][IO=2E8h; IRQ=3]

## 3.5.7 APM



### ErP Ready [Disabled]

This item allows user to switch off some power at S5 to get the system ready for ErP requirement. When set enabled to Enabled, all other PME options will be switched off.

Configuration options: [Disabled] [Enabled]

### Restore AC Power Loss [Power Off]

- [Power On] The system goes into on state after an AC power loss.
- [Power Off] The system goes into off state after an AC power loss.
- [Last State] The system goes into either off or on state, whatever the system state was before the AC power loss.

### Power On By PCIE/PCI [Disabled]

[Disabled] Disables the PCIE devices to generate a wake event.

[Enabled] Enables the PCIE devices to generate a wake event.

### Power On By Ring [Disabled]

[Disabled] Disables Ring to generate a wake event.

[Enabled] Enables Ring to generate a wake event.

### Power On By RTC [Disabled]

[Disabled] Disables RTC to generate a wake event.

[Enabled] When set to [Enabled], the items **RTC Alarm Date (Days)** and **Hour/Minute/Second** will become user-configurable with set values.

## 3.5.8 Network Stack



### Network Stack [Disable Link]

This item allows user to disable or enable the UEFI network stack.

Configuration options: [Disable Link] [Enabled]



---

The following items appears only when you set the Network Stack to **[Enabled]**.

---

### Ipv4 PXE Support [Enable]

This item allows user to disable or enable the Ipv4 PXE Support.

Configuration options: [Disable Link] [Enabled]

### Ipv6 PXE Support [Enable]

This item allows user to disable or enable the Ipv6 PXE Support.

Configuration options: [Disable Link] [Enabled]

## 3.6 Monitor menu

The Monitor menu displays the system temperature/power status, and allows you to change the fan settings.



Scroll down to display the following items:



Scroll down to display the following items:



## CPU Temperature / MB Temperature [xxx°C/xxx°F]

The onboard hardware monitor automatically detects and displays the CPU and motherboard temperatures. Select **Ignore** if you do not wish to display the detected temperatures.

## CPU Fan Speed [xxxx RPM] or [Ignore] / [N/A]

## CPU OPT Speed [xxxx RPM] or [Ignore] / [N/A]

## Chassis Fan 1/4 Speed [xxxx RPM] or [Ignore] / [N/A]

The onboard hardware monitor automatically detects and displays the CPU, chassis, and power fan speed in rotations per minute (RPM). If the fan is not connected to the motherboard, the field shows **N/A**. Select **Ignore** if you do not wish to display the detected speed.

## CPU Voltage, 3.3V Voltage, 5V Voltage, 12V Voltage

The onboard hardware monitor automatically detects the voltage output through the onboard voltage regulators. Select **Ignore** if you do not want to detect this item.

## CPU Q-Fan Control [Enabled]

[Disabled] Disables the CPU Q-Fan control feature.

[Enabled] Enables the CPU Q-Fan control feature.

## CPU Fan Speed Low Limit [600 RPM]

This item appears only when you enable the **CPU Q-Fan Control** feature and allows you to disable or set the CPU fan warning speed.

Configuration options: [Ignore] [200 RPM] [300 RPM] [400 RPM] [500 RPM] [600 RPM]

### *CPU Fan Profile [Standard]*

This item appears only when you enable the **CPU Q-Fan Control** feature and allows you to set the appropriate performance level of the CPU fan.

[Standard] Sets to [Standard] to make the CPU fan automatically adjust depending on the CPU temperature.

[Silent] Sets to [Silent] to minimize the fan speed for quiet CPU fan operation.

[Turbo] Sets to [Turbo] to achieve maximum CPU fan speed.

[Manual] Sets to [Manual] to assign detailed fan speed control parameters.



---

The following four items appear only when you set **CPU Fan Profile** to [Manual].

---

### **CPU Upper Temperature [70]**

Use the <+> and <-> keys to adjust the upper limit of the CPU temperature. The values range from 40°C to 90°C.

### **CPU Fan Max. Duty Cycle(%) [100]**

Use the <+> and <-> keys to adjust the maximum CPU fan duty cycle. The values range from 20% to 100%. When the CPU temperature reaches the upper limit, the CPU fan will operate at the maximum duty cycle.

**CPU Lower Temperature [20]**

Displays the lower limit of the CPU temperature.

**CPU Fan Min. Duty Cycle(%) [20]**

Use the <+> and <-> keys to adjust the minimum CPU fan duty cycle. The values range from 0% to 100%. When the CPU temperature is under 40°C, the CPU fan will operate at the minimum duty cycle.

**Chassis Q-Fan Control 1/4 [Enabled]**

[Disabled] Disables the Chassis Q-Fan control feature.

[Enabled] Enables the Chassis Q-Fan control feature.

**Chassis Fan Speed Low Limit 1/4 [600 RPM]**

This item appears only when you enable the **Chassis Q-Fan Control** feature and allows you to disable or set the chassis fan warning speed.

Configuration options: [Ignore] [200 RPM] [300 RPM] [400 RPM] [500 RPM] [600 RPM]

***Chassis Fan Profile 1/4 [Standard]***

This item appears only when you enable the **Chassis Q-Fan Control** feature and allows you to set the appropriate performance level of the chassis fan.

[Standard] Sets to [Standard] to make the chassis fan automatically adjust depending on the chassis temperature.

[Silent] Sets to [Silent] to minimize the fan speed for quiet chassis fan operation.

[Turbo] Sets to [Turbo] to achieve maximum chassis fan speed.

[Manual] Sets to [Manual] to assign detailed fan speed control parameters.



---

The following four items appear only when you set **Chassis Fan Profile** to [Manual].

---

**Chassis Upper Temperature [70]**

Use the <+> and <-> keys to adjust the upper limit of the CPU temperature. The values range from 40°C to 90°C.

**Chassis Fan Max. Duty Cycle(%) [100]**

Use the <+> and <-> keys to adjust the maximum chassis fan duty cycle. The values range from 20% to 100%. When the chassis temperature reaches the upper limit, the chassis fan will operate at the maximum duty cycle.

**Chassis Lower Temperature [40]**

Displays the lower limit of the chassis temperature.

**CPU Fan Min. Duty Cycle(%) [60]**

Use the <+> and <-> keys to adjust the minimum chassis fan duty cycle. The values range from 0% to 100%. When the chassis temperature is under 40°C, the chassis fan will operate at the minimum duty cycle.

**Anti Surge Support [Enabled]**

This item allows you to enable or disable the Anti Surge function.

Configuration options: [Disabled] [Enabled]

## 3.7 Boot menu

The Boot menu items allow you to change the system boot options.



Scroll down to display the following items:



### Bootup NumLock State [On]

[On] Sets the power-on state of the NumLock to [On].

[Off] Sets the power-on state of the NumLock to [Off].

### Full Screen Logo [Enabled]

[Enabled] Enables the full screen logo display feature.

[Disabled] Disables the full screen logo display feature.



Set this item to [Enabled] to use the ASUS MyLogo 2™ feature.

### Wait For 'F1' If Error [Enabled]

[Disabled] Disables this function.

[Enabled] The system waits for the <F1> key to be pressed when error occurs.



## Option ROM Messages [Force BIOS]

- [Force BIOS] The third-party ROM messages will be forced to display during the boot sequence.
- [Keep Current] The third-party ROM messages will be displayed only if the third-party manufacturer had set the add-on device to do so.

## Setup Mode [EZ Mode]

- [Advanced Mode] Sets Advanced Mode as the default screen for entering the BIOS setup program.
- [EZ Mode] Sets EZ Mode as the default screen for entering the BIOS setup program.

## UEFI/Legacy Boot [Enable both UEFI and Legacy]

- [Enable both UEFI and Legacy] Enables both UEFI and Legacy boot.
- [Disable UEFI] Enables the Legacy boot, and disables the UEFI boot.
- [Disable Legacy] Enables the UEFI boot, and disables the Legacy boot.

## PCI ROM Priority [Legacy ROM]

- [Legacy ROM] Launch Legacy ROM
- [EFI Compatible ROM] Launch UEFI Compatible ROM

## Boot Option Priorities

These items specify the boot device priority sequence from the available devices. The number of device items that appears on the screen depends on the number of devices installed in the system.



- To select the boot device during system startup, press <F8> when ASUS Logo appears.
- To access Windows OS in Safe Mode, do any of the following:
  - Press <F5> when ASUS Logo appears.
  - Press <F8> after POST.

## Boot Override

These items displays the available devices. The number of device items that appears on the screen depends on the number of devices installed in the system. Click an item to start booting from the selected device.

## 3.8 Tools menu

The Tools menu items allow you to configure options for special functions. Select an item then press <Enter> to display the submenu.



### 3.8.1 ASUS EZ Flash 2 Utility

Allows you to run ASUS EZ Flash 2. When you press <Enter>, a confirmation message appears. Use the left/right arrow key to select between [Yes] or [No], then press <Enter> to confirm your choice.



For more details, refer to [section 3.10.2 ASUS EZ Flash 2 utility](#).

### 3.8.2. ASUS O.C. Profile

This item allows you to store or load multiple BIOS settings.

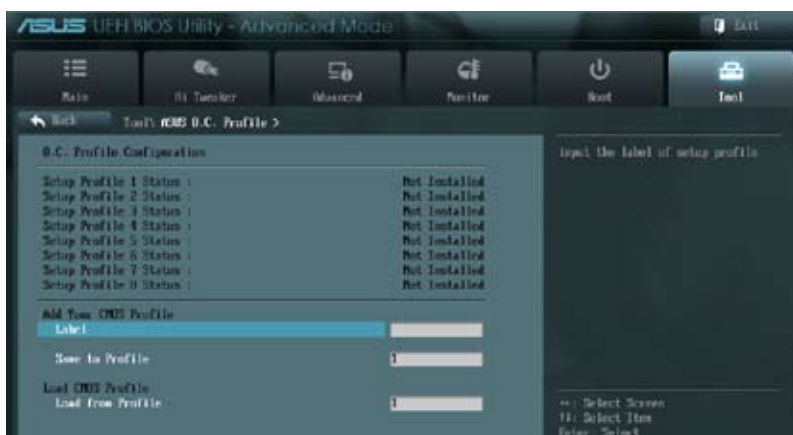

The **Setup Profile Status** items show **Not Installed** if no profile is created.

## Label

Allows you to input the label of the setup profiles.

## Save to Profile

Allows you to save the current BIOS settings to the BIOS Flash, and create a profile. Key in a profile number from one to eight, press <Enter>, and then select **Yes**.

## Load from Profile

Allows you to load the previous BIOS settings saved in the BIOS Flash. Key in the profile number that saved your BIOS settings, press <Enter>, and then select **Yes**.



- DO NOT shut down or reset the system while updating the BIOS to prevent the system boot failure!
- We recommend that you update the BIOS file only coming from the same memory/CPU configuration and BIOS version.

### 3.8.3. ASUS SPD Information

Allows you to view the DRAM SPD information.

The screenshot shows the ASUS UEFI BIOS Utility in Advanced Mode. The 'Tools' menu is open, and 'SPD Information' is selected. The main display shows the following information for DIMM Slot 4:

DIMM Slot 4	
Manufacturer	Samsung
Module Size	16384 Mbytes
Maximum Bandwidth	1333 Mhz
Part Number	M99132073821-019
Serial Number	0603079
Product Week/Year	15/2008
SPD Ext.	

JEDEC ID	JEDEC
Frequency (MHz)	1333
Voltage (V)	1.500
CRS# Latency (ns)	9
CRS# to CAS# (ns)	9
CRS# Precharge (ns)	9
tRCD	24
tRC	33
tRR	10
tRRD	4
tRFC	24
tRTT	5
tRTP	5
tRW	20

On the right side, there is a 'DIMM Slot number' field and a list of navigation options:

- ← Select Screen
- F1: Select Item
- Enter: Select
- ↵: Change Opt.
- F1: General Help
- F2: Previous Screen
- F3: Shortcut
- F4: Optimized Defaults
- F8: Save ESC: Exit
- F12: Print Screen

At the bottom, it says: Version 2.10.0258 - Copyright © 2012 American Megatrends, Inc.

### 3.8.4. ASUS Drive Xpert



- Before using the Drive Xpert function, ensure that you have connected the SATA signal cables and installed SATA hard disk drives to the **SATA6G\_E1** and **SATA6G\_E2** connectors.
- You can only make one Drive Xpert change a time before you save BIOS settings and restart the computer.



#### Drive Xpert Mode [Normal Mode]

[Normal Mode] Allows you to use the SATA6G\_E1 and SATA6G\_E2 connectors as normal SATA connectors.

[Super Speed] Allows you to use the **Super Speed** function that combines two hard drives as one single drive partition.

[EZ Backup] Allows you to use the **EZ Backup** function that copies and maintains an identical image of data from the SATA6G\_E1 drive to the SATA6G\_E2 drive.



When using only one hard disk in **Normal Mode**, connect the hard disk to the SATA6G\_E1 connector on the motherboard.



- All original data of the two hard drives will be erased for Super Speed setup.
- All original data of the SATA6G\_E2 hard disk will be erased for EZ Backup setup.

#### Drive Xpert Device(s) List:

*SATA 6G E1 (Blue) / SATA 6G E2 (Blue)*

Press <Enter> to display the information of the hard disks which are connected to the SATA6G\_E1 and SATA6G\_E2 connectors on the motherboard.

## 3.9 Exit menu

The Exit menu items allow you to load the optimal default values for the BIOS items, and save or discard your changes to the BIOS items. You can access the **EZ Mode** from the Exit menu.



### Load Optimized Defaults

This option allows you to load the default values for each of the parameters on the Setup menus. When you select this option or if you press <F5>, a confirmation window appears. Select **Yes** to load the default values.

### Save Changes & Reset

Once you are finished making your selections, choose this option from the Exit menu to ensure the values you selected are saved. When you select this option or if you press <F10>, a confirmation window appears. Select **Yes** to save changes and exit.

### Discard Changes & Exit

This option allows you to exit the Setup program without saving your changes. When you select this option or if you press <Esc>, a confirmation window appears. Select **Yes** to discard changes and exit.

### ASUS EZ Mode

This option allows you to enter the EZ Mode screen.

### Launch EFI Shell from filesystem device

This option allows you to attempt to launch the EFI Shell application (shellx64.efi) from one of the available filesystem devices.

## 3.10 Updating BIOS

The ASUS website publishes the latest BIOS versions to provide enhancements on system stability, compatibility, or performance. However, BIOS updating is potentially risky. If there is no problem using the current version of BIOS, **DO NOT manually update the BIOS**. Inappropriate BIOS updating may result in the system's failure to boot. Carefully follow the instructions of this chapter to update your BIOS if necessary.



---

Visit the ASUS website ([www.asus.com](http://www.asus.com)) to download the latest BIOS file for this motherboard.

---

The following utilities allow you to manage and update the motherboard BIOS setup program.

1. **ASUS Update:** Updates the BIOS in Windows® environment.
2. **ASUS EZ Flash 2:** Updates the BIOS using a USB flash drive.
3. **ASUS CrashFree BIOS 3:** Restores the BIOS using the motherboard support DVD or a USB flash drive when the BIOS file fails or gets corrupted.
4. **ASUS BIOS Updater:** Updates and backups the BIOS in DOS environment using the motherboard support DVD and a USB flash disk drive.

Refer to the corresponding sections for details on these utilities.



---

Save a copy of the original motherboard BIOS file to a USB flash disk in case you need to restore the BIOS in the future. Copy the original motherboard BIOS using the **ASUS Update** or **BIOS Updater** utilities.

---

### 3.10.1 ASUS Update utility

The ASUS Update is a utility that allows you to manage, save, and update the motherboard BIOS in Windows® environment. The ASUS Update utility allows you to:

- Update the BIOS directly from the Internet
- Download the latest BIOS file from the Internet
- Update the BIOS from an updated BIOS file
- Save the current BIOS file
- View the BIOS version information

This utility is available in the support DVD that comes with the motherboard package.



---

ASUS Update requires an Internet connection either through a network or an Internet Service Provider (ISP).

---

### Launching ASUS Update

After installing AI Suite II from the motherboard support DVD, launch ASUS Update by clicking **Update > ASUS Update** on the AI Suite II main menu bar.



---

Quit all Windows® applications before you update the BIOS using this utility.

---

## Updating the BIOS through the Internet

To update the BIOS through the Internet:

1. From the ASUS Update screen, select **Update BIOS from Internet**, and then click **Next**.



2. Select the ASUS FTP site nearest you to avoid network traffic.  
If you want to enable the BIOS downgradable function and auto BIOS backup function, check the checkboxes before the two items on the screen.



3. Select the BIOS version that you want to download. Click **Next**.



4. You can decide whether to change the BIOS boot logo, which is the image appearing on screen during the Power-On Self-Tests (POST). Click **Yes** if you want to change the boot logo or **No** to continue.
5. Follow the onscreen instructions to complete the update process.



## Updating the BIOS through a BIOS file

To update the BIOS through a BIOS file:

1. From the ASUS Update screen, select **Update BIOS from file**, and then click **Next**.



2. Locate the BIOS file from the Open window, click **Open**, and click **Next**.



3. You can decide whether to change the BIOS boot logo. Click **Yes** if you want to change the boot logo or **No** to continue.
4. Follow the onscreen instructions to complete the update process.

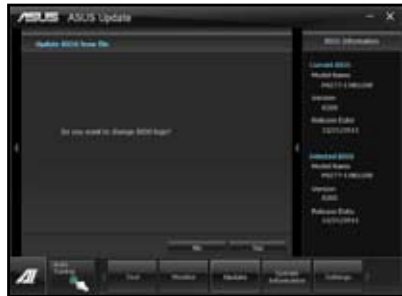

- The screenshots in this section are for reference only. The actual BIOS information vary by models.
- Refer to the software manual in the support DVD or visit the ASUS website at [www.asus.com](http://www.asus.com) for detailed software configuration.



### 3.10.2 ASUS EZ Flash 2 utility

The ASUS EZ Flash 2 feature allows you to update the BIOS without having to use a bootable floppy disk or an OS-based utility.



Before you start using this utility, download the latest BIOS from the ASUS website at [www.asus.com](http://www.asus.com).

To update the BIOS using EZ Flash 2:

1. Insert the USB flash disk that contains the latest BIOS file to the USB port.
2. Enter the Advanced Mode of the BIOS setup program. Go to the **Tool** menu to select **ASUS EZ Flash Utility** and press <Enter> to enable it.

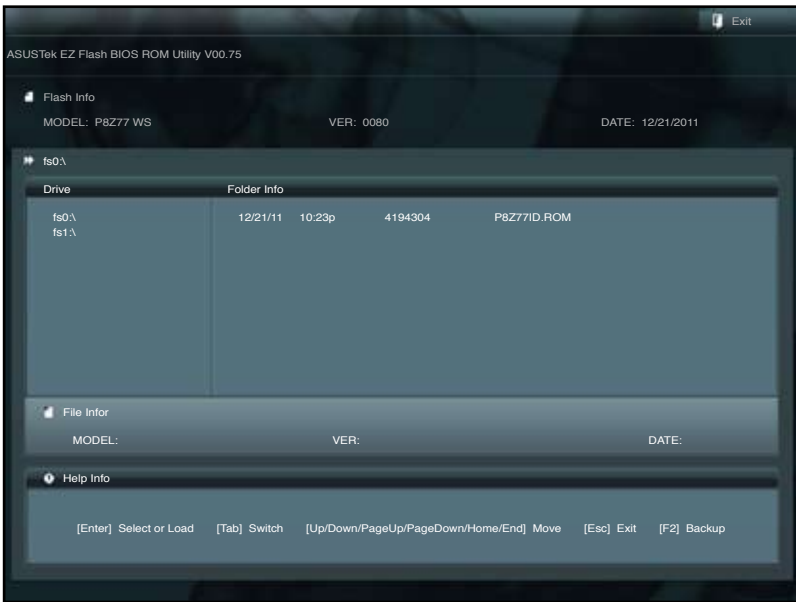

3. Press <Tab> to switch to the Drive field.
4. Press the Up/Down arrow keys to find the USB flash disk that contains the latest BIOS, and then press <Enter>.
5. Press <Tab> to switch to the Folder Info field.
6. Press the Up/Down arrow keys to find the BIOS file, and then press <Enter> to perform the BIOS update process. Reboot the system when the update process is done.



- 
- This function can support devices such as a USB flash disk with FAT 32/16 format and single partition only.
  - DO NOT shut down or reset the system while updating the BIOS to prevent system boot failure!
- 



---

Ensure to load the BIOS default settings to ensure system compatibility and stability. Select the **Load Optimized Defaults** item under the **Exit** menu. See section 3.9 **Exit Menu** for details.

---

### 3.10.3 ASUS CrashFree BIOS 3 utility

The ASUS CrashFree BIOS 3 utility is an auto recovery tool that allows you to restore the BIOS file when it fails or gets corrupted during the updating process. You can restore a corrupted BIOS file using the motherboard support DVD or a USB flash drive that contains the BIOS file.



---

The BIOS file in the motherboard support DVD may be older than the BIOS file published on the ASUS official website. If you want to use the newer BIOS file, download the file at [support.asus.com](http://support.asus.com) and save it to a USB flash drive.

---

## Recovering the BIOS

To recover the BIOS:

1. Turn on the system.
2. Insert the motherboard support DVD to the optical drive, or the USB flash drive containing the BIOS file to the USB port.
3. The utility automatically checks the devices for the BIOS file. When found, the utility reads the BIOS file and enters ASUS EZ Flash 2 utility automatically.
4. The system requires you to enter BIOS Setup to recover BIOS setting. To ensure system compatibility and stability, we recommend that you press <F5> to load default BIOS values.



---

DO NOT shut down or reset the system while updating the BIOS! Doing so can cause system boot failure!

---

### 3.10.4 ASUS BIOS Updater

The ASUS BIOS Updater allows you to update BIOS in DOS environment. This utility also allows you to copy the current BIOS file that you can use as a backup when the BIOS fails or gets corrupted during the updating process.



The succeeding utility screens are for reference only. The actual utility screen displays may not be same as shown.

#### Before updating BIOS

1. Prepare the motherboard support DVD and a USB flash drive in FAT32/16 format and single partition.
2. Download the latest BIOS file and BIOS Updater from the ASUS website at <http://support.asus.com> and save them on the USB flash drive.



- NTFS is not supported under DOS environment. Do not save the BIOS file and BIOS Updater to a hard disk drive or USB flash drive in NTFS format.
- Do not save the BIOS file to a floppy disk due to low disk capacity.

3. Turn off the computer and disconnect all SATA hard disk drives (optional).

#### Booting the system in DOS environment

1. Insert the USB flash drive with the latest BIOS file and BIOS Updater to the USB port.
2. Boot your computer. When the ASUS Logo appears, press <F8> to show the **BIOS Boot Device Select Menu**. Insert the support DVD into the optical drive and select the optical drive as the boot device.

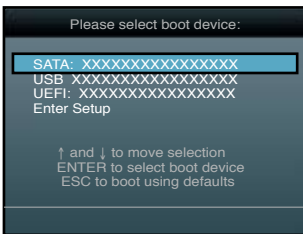

3. When the **Make Disk** menu appears, select the **FreeDOS command prompt** item by pressing the item number.
4. At the FreeDOS prompt, type **d:** and press <Enter> to switch the disk from Drive C (optical drive) to Drive D (USB flash drive).

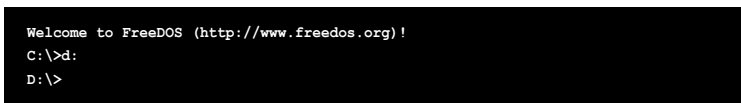

## Updating the BIOS file

To update the BIOS file using BIOS Updater

1. At the FreeDOS prompt, type `bupdater /i <xxxxx.rom>` and press <Enter>.

```
D:\>bupdater /i <xxxxx.rom>
```

2. The BIOS Updater screen appears as below.

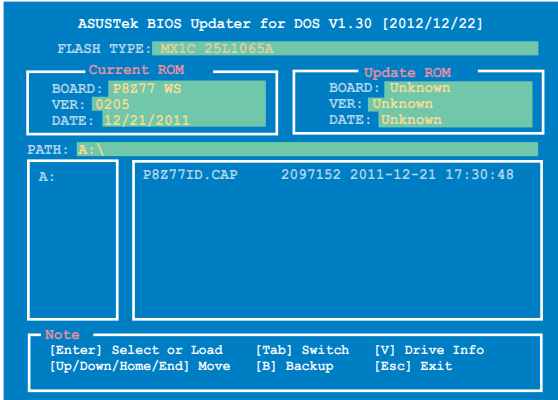

3. Press <Tab> to switch between screen fields and use the <Up/Down/Home/End> keys to select the BIOS file and press <Enter>. BIOS Updater checks the selected BIOS file and prompts you to confirm BIOS update.



4. Select **Yes** and press <Enter>. When BIOS update is done, press <ESC> to exit BIOS Updater. Restart your computer.



DO NOT shut down or reset the system while updating the BIOS to prevent system boot failure!



- For BIOS Updater version 1.04 or later, the utility automatically exits to the DOS prompt after updating BIOS.
- Ensure to load the BIOS default settings to ensure system compatibility and stability. Select the **Load Optimized Defaults** item under the **Exit** BIOS menu. See Chapter 3 of your motherboard user manual for details.
- Ensure to connect all SATA hard disk drives after updating the BIOS file if you have disconnected them.

# Chapter 4

## 4.1 Installing an operating system

This motherboard supports Windows® XP/ 64-bit XP/ 7 / 64-bit 7 operating systems (OS). Always install the latest OS version and corresponding updates to maximize the features of your hardware.



- Motherboard settings and hardware options vary. Use the setup procedures presented in this chapter for reference only. Refer to your OS documentation for detailed information.
- Ensure that you install the Windows® XP Service Pack 3 or later versions before installing the drivers for better compatibility and system stability.

## 4.2 Support DVD information

The support DVD that comes with the motherboard package contains the drivers, software applications, and utilities that you can install to avail all motherboard features.



The contents of the support DVD are subject to change at any time without notice. Visit the ASUS website at [www.asus.com](http://www.asus.com) for updates.

### 4.2.1 Running the support DVD

Place the support DVD into the optical drive. The DVD automatically displays the Drivers menu if Autorun is enabled in your computer. Click each menu tab and select the items you want to install.

The Drivers menu shows the available device drivers if the system detects installed devices. Install the necessary drivers to use the devices.

The Make Disk menu contains items to create the RAID/AHCI driver disk.

The Manual menu contains the list of supplementary user manuals. Click an item to open the folder of the user manual.

The Utilities menu shows the applications and other software that the motherboard supports.

Click an item to install



Click the Contact tab to display the ASUS contact information.

Click an icon to display DVD/motherboard information



If Autorun is NOT enabled in your computer, browse the contents of the support DVD to locate the file ASSETUP.EXE from the BIN folder. Double-click the ASSETUP.EXE to run the DVD.

## 4.2.2 Obtaining the software manuals

The software manuals are included in the support DVD. Follow the instructions below to get the necessary software manuals.



The software manual files are in Portable Document Format (PDF). Install the Adobe® Acrobat® Reader from the Utilities menu before opening the files.

1. Click the **Manual** tab. Click **ASUS Motherboard Utility Guide** from the manual list on the left.



2. The **Manual** folder of the support DVD appears. Double-click the folder of your selected software.

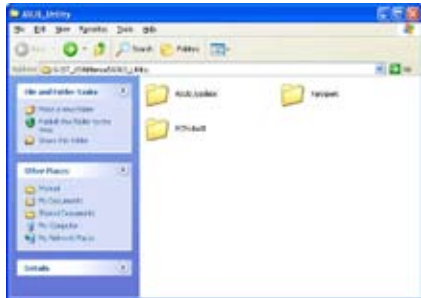

3. Some software manuals are provided in different languages. Double-click the language to show the software manual.

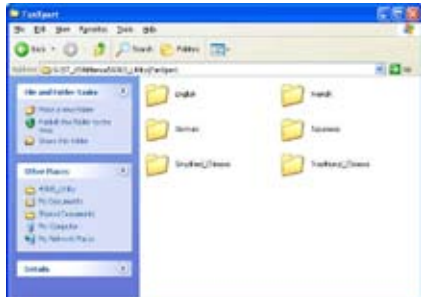

The screenshots in this section are for reference only. The actual software manuals containing in the support DVD vary by models.

## 4.3 Software information

Most of the applications in the support DVD have wizards that will conveniently guide you through the installation. View the online help or readme file that came with the software application for more information.

### 4.3.1 AI Suite II

AI Suite II is an all-in-one interface that integrates several ASUS utilities and allows users to launch and operate these utilities simultaneously.

#### Installing AI Suite II

To install AI Suite II on your computer

1. Place the support DVD to the optical drive. The Drivers installation tab appears if your computer has enabled the Autorun feature.
2. Click the Utilities tab, then click **AI Suite II**.
3. Follow the onscreen instructions to complete installation.

#### Using AI Suite II

AI Suite II automatically starts when you enter the Windows® operating system (OS). The AI Suite II icon appears in the Windows® notification area. Click the icon to open the AI Suite II main menu bar.

Click each button to select and launch a utility, to monitor the system, to update the motherboard BIOS, to display the system information, and to customize the settings of AI Suite II.

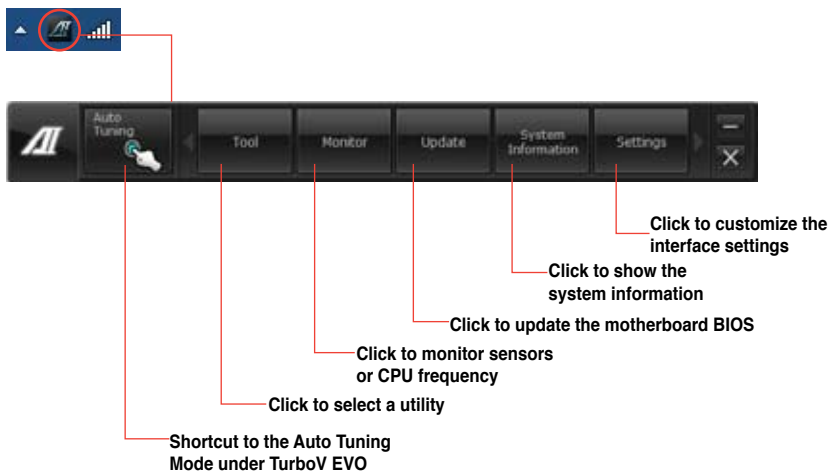

- The **Auto Tuning** button appears only on models with the TurboV EVO function.
- The applications in the Tool menu vary with models.
- The screenshots of AI Suite II in this user manual are for reference only. The actual screenshots vary with models.
- Refer to the software manual in the support DVD or visit the ASUS website at [www.asus.com](http://www.asus.com) for detailed software configuration.

## 4.3.2 TurboV EVO

ASUS TurboV EVO introduces **TurboV** that allows you to manually adjust the CPU frequency and related voltages as well as **Auto Tuning** function that offers automatic and easy overclocking and system level up. After installing AI Suite II from the motherboard support DVD, launch TurboV EVO by clicking **Tool > TurboV EVO** on the AI Suite II main menu bar.



Refer to the software manual in the support DVD or visit the ASUS website at [www.asus.com](http://www.asus.com) for detailed software configuration.

### TurboV

TurboV allows you to overclock the BCLK frequency, CPU voltage, IMC voltage, and DRAM Bus voltage in Windows® environment and takes effect in real-time without exiting and rebooting the OS.



Refer to the CPU documentation before adjusting CPU voltage settings. Setting a high voltage may damage the CPU permanently, and setting a low voltage may make the system unstable.



For system stability, all changes made in TurboV will not be saved to BIOS settings and will not be kept on the next system boot. Use the **Save Profile** function to save your customized overclocking settings and manually load the profile after Windows starts.

The screenshot shows the ASUS TurboV EVO software interface. It is divided into two main sections: Manual Mode and Advanced Mode. The Manual Mode section includes a 'Profile' dropdown, 'Save Profile' and 'Load Profile' buttons, and a table of settings for BCLK, CPU, and DRAM voltages and frequencies. The Advanced Mode section shows CPU ratios and various voltage sliders (VCCSA, VCCIO, CPU/FLL, PCH). On the right side, there are CPU frequency and usage monitors. At the bottom, there are buttons for 'OS Default Settings', 'Auto Tuning', 'Exit', 'Monitor', 'Default', 'Restore Information', and 'Settings'.

Click to select mode

Load profile

Target values

Current values

Click to show settings

Click to restore all start-up settings

Save the current settings as a new profile

Voltage Adjustment bars

Undoes all changes without applying

Applies all changes immediately



## Using Advanced Mode

Click on the **Advanced Mode** tab to adjust the advanced voltage settings.

**Advanced mode**

**Target values**

**Current values**

**Click to restore all start-up settings**

**Voltage Adjustment bars**

**Undoes all changes without applying**

**Applies all changes immediately**

## CPU Ratio

Allows you to manually adjust the CPU ratio.



The first time you use **CPU Ratio**, go to **AI Tweaker > CPU Power Management** in BIOS and set the **Turbo Ratio** item to **[Maximum Turbo Ratio setting in OS]**.

1. Click on the **CPU Ratio** tab.
2. Drag the adjustment bar upwards or downwards to the desired value.
3. Click on **Apply** to make the change take effect.

**CPU Ratio**

**Adjustment bar**

**Click to restore all start-up settings**

**Undoes all changes without applying**

**Applies all changes immediately**



- Set the **CPU Ratio Setting** item in BIOS to **[Auto]** before using the CPU Ratio function in TurboV. Refer to Chapter 3 of your motherboard user manual for details.
- The CPU Ratio bars show the status of the CPU cores, which vary with your CPU model.

## Auto Tuning

ASUS TurboV EVO includes two auto tuning modes, providing the most flexible auto-tuning options.



- The overclocking result varies with the CPU model and the system configuration.
- To prevent overheating from damaging the motherboard, a better thermal environment is strongly recommended.

- **Fast Tuning:** fast CPU overclocking
- **Extreme Tuning:** extreme overclocking for CPU and memory

### Using Fast Tuning

1. Click the **Auto Tuning** tab and then click **Fast**.
2. Read through the warning messages and click **OK** to start auto-overclocking.



3. TurboV automatically overclocks the CPU, saves BIOS settings and restarts the system. After re-entering Windows, a message appears indicating auto tuning success. Click **OK** to exit.



### Using Extreme Tuning

1. Click the **Auto Tuning** tab and then click **Extreme**.
2. Read through the warning messages and click **OK** to start auto-overclocking.



3. TurboV automatically overlocks the CPU and memory and restarts the system. After re-entering Windows, a message appears indicating the current overlocking result. To keep the result, click **Stop**.



4. If you did not click **Stop** in the previous step, TurboV automatically starts further system overlocking and stability test. An animation appears indicating the overlocking process. Click **Stop** if you want to cancel the Overlocking process.



5. TurboV automatically adjusts and saves BIOS settings and restarts the system. After re-entering Windows, a message appears indicating auto tuning success. Click **OK** to exit.



## Ai Charger+

Battery Charging Version 1.1 (BC 1.1), a USB Implementers Forum (USB-IF) certified USB charging function, is designed to make USB charging faster than the standard USB devices. If your USB device supports the BC 1.1 function\*, when you connect your USB device to your system, the system automatically detects your USB device and starts a fast USB charging. The charging speed may get 3 times faster than that of the standard USB devices\*\*.



- \* Check your USB device manufacturer if it fully supports the BC 1.1 function.
- \*\* The actual charging speed may vary with your USB device's conditions.
- Ensure to remove and reconnect your USB device after enabling or disabling Ai Charger+ to ensure normal charging function.



### 4.3.3 DIGI+ Power Control

DIGI+ PowerControl allows you to adjust the VRM voltage and frequency modulation to enhance reliability and stability. It also provides profile settings to achieve the highest power efficiency, generating less heat to prolong component lifespan, and minimize power loss. After installing AI Suite II from the motherboard support DVD, launch DIGI+ Power Control by clicking **Tool > DIGI+ Power Control** on the AI Suite II main menu bar. Select **CPU Power** or **DRAM Power** to adjust the power control settings.

#### Smart DIGI+



Function no.	Function description
1	<b>Smart DIGI+ Key</b> Quickly delivers a higher VRM frequency, voltage, and current for superior CPU/iGPU/DRAM overclocking performance with one switch.
2	<b>Smart CPU Power Level - 45W</b> CPU power usage is limited to 45W to achieve the best digital power saving conditions.
3	<b>Smart CPU Power Level - 35W</b> CPU power usage is limited to 35W to achieve the best digital power saving mode.
4	<b>OC Now!</b> Adjusts the CPU ratio in TurboV EVO.
5	<b>Default (Smart DIGI+ Setting)</b> Sets your CPU/iGPU/DRAM power to default settings.
6	<b>Default (Smart CPU Power Level)</b> Sets your power consumption to CPU default setting.



Enabling the Smart CPU Power Level may decrease the total power delivery to the CPU, and affect the CPU performance under a heavy system load. The system restores to its default settings on the next startup.

## CPU Power

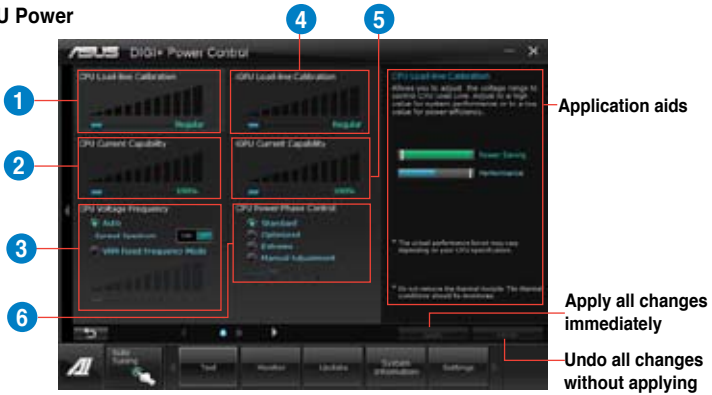

Function no.	Function description
1	<b>CPU Load-line Calibration</b> It allows you to adjust the voltage settings and control the system temperature. Higher load-line calibration could get higher voltage and good overclocking performance but increases the CPU and VRM thermal.
2	<b>CPU Current Capability</b> CPU Current Capability provides wider total power range for overclocking. A higher value setting gets higher VRM power consumption delivery.
3	<b>CPU Voltage Frequency</b> Switching frequency will affect the VRM transient response and component thermal. Higher frequency gets quicker transient response.

Function no.	Function description
4	<p><b>iGPU Load-line Calibration</b></p> <p>Load-line is defined by Intel VRM specifications, and affects the iGPU voltage. The iGPU working voltage decreases proportionally to integrated graphics loading. A higher value can get a higher iGPU voltage, and a good performance, but decreases the CPU and VRM thermal conditions.</p>
5	<p><b>iGPU Current Capability</b></p> <p>A higher value brings wider total iGPU power range, and extends the overclocking frequency range simultaneously to enhance the iGPU performance.</p>
6	<p><b>CPU Power Phase Control</b></p> <p>Increase phase number under heavy system loading to get more transient and better thermal performance. Reduce phase number under light system loading to increase VRM efficiency.</p>
7	<p><b>CPU Power Thermal Control</b></p> <p>A higher temperature brings a wider CPU power thermal range, and extends the overclocking tolerance to enlarge overclocking potential.</p>
8	<p><b>CPU Power Response Control</b></p> <p>The DIGI+ VRM controller provides a faster and precise power response rate for CPU. Apply a higher value for an extreme overclocking.</p>
9	<p><b>CPU Power Duty Control</b></p> <p>CPU Power Duty Control adjusts the current of every VRM phase and the thermal of every phase component.</p>

## DRAM Power

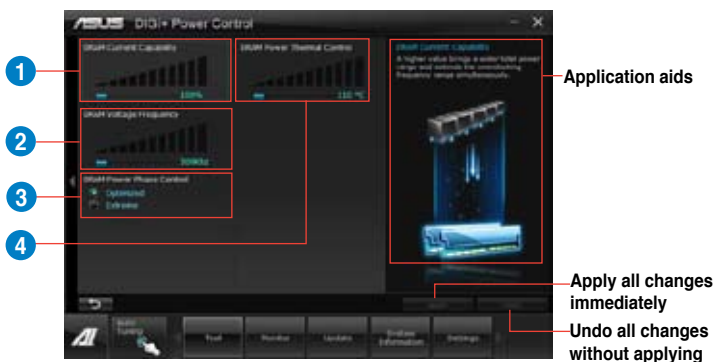

Function no.	Function description
1	<b>DRAM Current Capability</b> A higher value brings a wider total power range and extends the overclocking frequency range simultaneously.
2	<b>DRAM Voltage Frequency</b> Allows you to adjust the DRAM switching frequency for system stability or to increase OC Range.
3	<b>DRAM Power Phase Control</b> Select <b>Extreme</b> for full phase mode to increase system performance or select <b>Optimized</b> for ASUS optimized phase tuning profile to increase DRAM power efficiency.
4	<b>DRAM Power Thermal Control</b> A higher temperature brings a wider DRAM power thermal range, and extends the overclocking tolerance to enlarge overclocking potential.



- The actual performance boost may vary depending on your CPU specification.
- Do not remove the thermal module. The thermal conditions must be monitored.



### 4.3.4 EPU

EPU is an energy-efficient tool that satisfies different computing needs. This utility provides several modes that you can select to save system power. Selecting Auto mode will have the system shift modes automatically according to current system status. You can also customize each mode by configuring settings like CPU frequency, GPU frequency, vCore Voltage, and Fan Control.

#### Launching EPU

After installing AI Suite II from the motherboard support DVD, launch EPU by clicking **Tool > EPU** on the AI Suite II main menu bar.

The screenshot shows the ASUS EPU utility interface. At the top, there are three operating modes: **Auto** (selected), **High performance**, and **Max. power saving**. Below these are five system property icons: **Transparency**, **Performance**, **Consistency**, **Reliability**, and **Energy Saving**. On the right side, there is a panel with several indicators: **EPU Modes** (with icons for CPU, GPU, vCore, and Fan), **Reduced CO2 Emission** (showing 6,000 mg), **Filter Selected** (with options for 'From EPU Installation' and 'From the Last Reset'), and **Current CPU Power** (showing 2.50 Watts). A bottom navigation bar includes **Auto Tuning**, **Tool**, **Monitor**, **Update**, **System Information**, and **Exit/Help**.

**Multiple system operating modes**

**Displays the following message if no VGA power saving engine is detected.**

**The items lighting up means power saving engine is activated**

**Displays the amount of CO2 reduced**

**\*Shifts between the display of Total and Current CO2 reduced**

**Displays the current CPU power**

**Advanced settings for each mode**

**Displays the system properties of each mode**



- \* Select **From EPU Installation** to show the CO2 that has been reduced since you installed EPU.
- \* Select **From the Last Reset** to show the total CO2 that has been reduced since you click the Clear button .
- Refer to the software manual in the support DVD or visit the ASUS website at [www.asus.com](http://www.asus.com) for detailed software configuration.

### 4.3.5 Probe II

Probe II is a utility that monitors the computer's vital components, and detects and alerts you of any problem with these components. Probe II senses fan rotations, CPU temperature, and system voltages, among others. With this utility, you are assured that your computer is always at a healthy operating condition.

#### Launching Probe II

After installing AI Suite II from the motherboard support DVD, launch Probe II by clicking **Tool > Probe II** on the AI Suite II main menu bar.

#### Configuring Probe II

Click the **Voltage/Temperature/Fan Speed** tabs to activate the sensors or to adjust the sensor threshold values. The **Preference** tab allows you to customize the time interval of sensor alerts, or change the temperature unit.

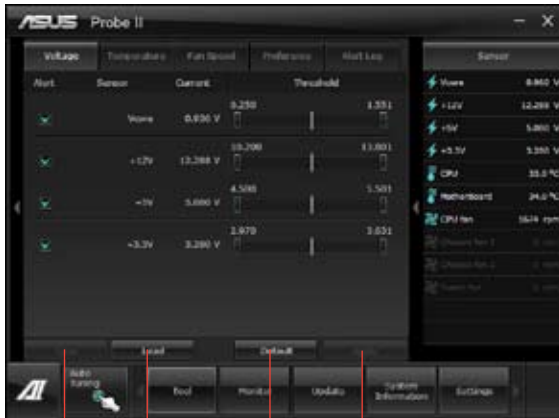

Saves your configuration

Loads your saved configuration

Loads the default threshold values for each sensor

Applies your changes



Refer to the software manual in the support DVD or visit the ASUS website at [www.asus.com](http://www.asus.com) for detailed software configuration.

### 4.3.6 FAN Xpert

Fan Xpert intelligently allows you to adjust both the CPU and chassis fan speeds according to different ambient temperatures caused by different climate conditions in different geographic regions and your PC's system loading. The built-in variety of useful profiles offer flexible controls of fan speed to achieve a quiet and cool environment.

#### Launching FAN Xpert

After installing AI Suite II from the motherboard support DVD, launch FAN Xpert by clicking **Tool > Fan Xpert** on the AI Suite II main menu bar.

#### Using FAN Xpert

Click **Fan Name** to select a fan and then click **Setting** to select a preset mode for your selected fan.

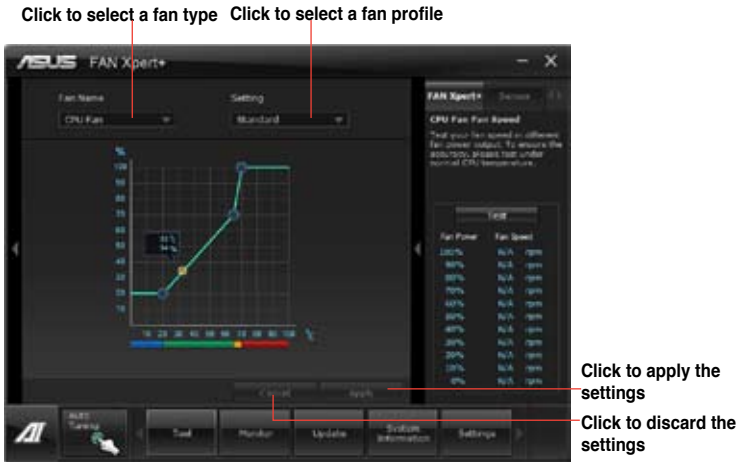

#### Fan setting

- **Disable:** disables the Fan Xpert function.
- **Standard:** adjusts fan speed in a moderate pattern.
- **Silent:** minimizes fan speed for quiet fan operation.
- **Turbo:** maximizes the fan speed for the best cooling effect.
- **Intelligent:** automatically adjusts the CPU fan speed according to the ambient temperature.
- **Stable:** fixes the CPU fan speed to avoid noise caused by the unsteady fan rotation. However, the fan will speed up when the temperature exceeds 70°C.
- **User:** Allows you to configure the CPU fan profile under certain limitations.



Refer to the software manual in the support DVD or visit the ASUS website at [www.asus.com](http://www.asus.com) for detailed software configuration.

### 4.3.7 Sensor Recorder

Sensor Recorder monitors the changes in the system voltage, temperature, and fan speed on a timeline. The History Record function allows you to designate specific time spans on record to keep track of the three system statuses for certain purposes.

#### Launching Sensor Recorder

After installing AI Suite II from the motherboard support DVD, launch Sensor Recorder by clicking **Tool > Sensor Recorder** on the AI Suite II main menu bar.

#### Using Sensor Recorder

Click on **Voltage/ Temperature/ Fan Speed** tabs for the status you want to monitor. Colored lines will automatically appear on the diagram to indicate the immediate changes in the system status.



#### Using History Record

1. Click on the **History Record** tab and adjust the settings on the left for **Record Interval** and **Record Duration** according to need.
2. Click on **Start Recording** to start measurement and recording of each sensor.
3. To stop recording, click on **Recording** again.
4. To track the recorded contents, set **Type/ Date/ Select display items** to display the history details.



Click on **Monitor > Sensor** on the AI Suite II main menu bar and a highlight of the system statuses will appear on the right panel.

## 4.3.8 USB BIOS Flashback Wizard

This utility allows you to check and save the latest BIOS version to a USB storage device. With ASUS USB BIOS Flashback hardware feature, the system BIOS is conveniently updated without booting your system.

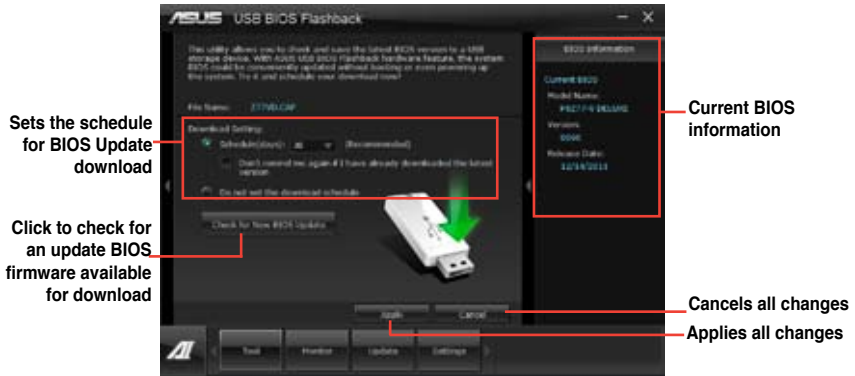

### Scheduling the latest BIOS download

1. In the **Download Setting** field, tick **Schedule (days)** and select the number of days for the next download update available.
2. Click **Apply** to save the BIOS download schedule. Click **Cancel** to cancel the changes made.

### Downloading the updated BIOS



Plug the flash drive before you start downloading.

1. Click **Check for New BIOS Update** to look for an updated BIOS firmware.
2. Wait for the system to check the latest BIOS firmware.



3. After the utility detects a new BIOS firmware, save the BIOS firmware by clicking  from the **Save to** field, select the USB flashdrive, and click **Download**.

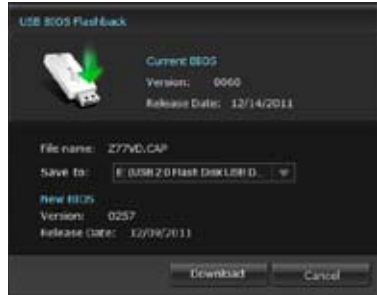

4. After the download is complete, click **OK**.



After you download the BIOS file to your flash drive, you can update the motherboard's BIOS. Refer to **2.3.11 USB BIOS Flashback** for details.

### 4.3.9 USB 3.0 Boost

The ASUS exclusive USB 3.0 Boost provides speed boost for USB 3.0 devices and the up-to-date support of USB Attached SCSI Protocol (UASP). With USB 3.0 Boost, you can accelerate the transfer speed of your USB 3.0 devices with ease.

#### Launching USB 3.0 Boost

After installing AI Suite II from the motherboard support DVD, launch USB 3.0 Boost by clicking **Tool > USB 3.0 Boost** on the AI Suite II main menu bar.

#### Configuring USB 3.0 Boost

1. Connect a USB 3.0 device to the USB 3.0 port.
2. USB 3.0 Boost automatically detects the property of the connected device and switches to **Turbo** mode or **UASP** mode (if UASP is supported by the connected device).
3. You can manually switch the USB 3.0 mode back to **Normal** mode at any time.



- Refer to the software manual in the support DVD or visit the ASUS website at [www.asus.com](http://www.asus.com) for detailed software configuration.
- Due to Intel® chipset limitation, Intel® USB 3.0 ports do not support ASUS 3.0 Boost in Windows XP operating system.
- Use the USB 3.0 devices for high performance. The data transfer speed varies with USB devices.

### 4.3.10 ASUS Update

ASUS Update lays out the options for updating BIOS on your system. Update BIOS utility on your system or simply save the utility for later use just by following the directions on this convenient updating feature.

#### Launching ASUS Update

After installing AI Suite II from the motherboard support DVD, launch ASUS Update by clicking **Update> ASUS Update** on the AI Suite II main menu bar.

#### Using ASUS Update

Select the way you would like to do with the BIOS utility. Click on **Next** and follow the instructions to complete your request.

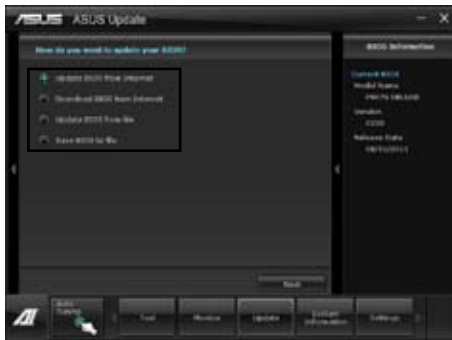

- **Update BIOS from Internet**  
Download the latest BIOS utility from the ASUS service website ([www.asus.com](http://www.asus.com)) and follow the suggested procedures to update the BIOS version on your system.
- **Download BIOS from Internet**  
Download the latest BIOS utility from the ASUS service website ([www.asus.com](http://www.asus.com)) and save for later use.
- **Update BIOS from file**  
Use the BIOS utility demanded from a source file to update the BIOS version on your system.



---

There may be risks of system crash when updating BIOS. Backing up the original BIOS utility is recommended before updating.

---



### 4.3.11 ASUS SSD Caching

This feature boosts system performance by using an installed SSD with no capacity limitations as a cache for frequently accessed data. Harness a combination of SSD-like performance and response and hard drive capacity with just one click. No rebooting is needed with instant activation for complete ease of use.

#### Launching ASUS SSD Caching

After installing AI Suite II from the motherboard support DVD, launch ASUS SSD Caching by clicking **Tool > ASUS SSD Caching** on the AI Suite II main menu bar.

#### Configuring ASUS SSD Caching

1. Connect one HDD and one SSD to the the Marvell® SATA ports (SATA6G\_E1/E2). ASUS SSD Caching automatically detects the HDD and SSD.
2. Click on **Caching Now!** to initialize the connected disks. Initialization status is shown on the program interface.
3. Caching function will be activated once initialization is complete.
4. Click on **Disable** when deactivating SSD caching.



- During initialization, you can proceed with doing any system operations. You can check the caching status later or wait for a pop-up message notifying that initialization is completed.
- For regular usage, the SATA6G\_E1/E2 connectors are recommended for data drives.
- After disabling SSD Caching, the SSD will become a non-configurable disk in Windows OS. To use the SSD again for normal functions, go to Disk Management to reconfigure the SSD.

### 4.3.12 Network iControl

ASUS Network iControl, a one-stop setup network control center that gives you the EZ Start, Quick Connection, and EZ Profile functions, makes it easier for you to manage your network bandwidth. It also allows you to automatically connect to a PPPoE network for a more convenient online experience.

To launch Network iControl, click **Tool > Network iControl** from AI Suite II main menu bar.



- Ensure to install the LAN drivers before using this function.
- Network iControl is only supported under Windows 7 and can only support the onboard LAN.

### Using EZ Start

EZ Start allows you to quickly activate Network iControl, and set the highest bandwidth priority for your top currently running program.

#### To use EZ Start:

1. Click the EZ Start tab.
2. Click **ON/OFF** to enable/disable Network iControl.



- By default, Network iControl is set to **ON**.
- When switched off, the **Quick Connection**, **EZ Profile** and **Info** are disabled.
- You may monitor the bandwidth priority from your desktop's taskbar.

3. Tick **Set current network program as the highest priority** to enable **User Profile**.
4. Select a profile and click **Apply**.



You may also apply your personal profile in **EZ Start**.

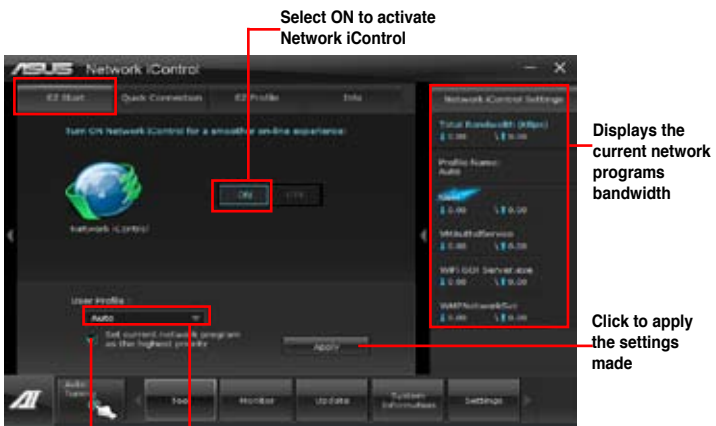

Click to enable the network program as the highest priority

Click to select a profile

Displays the current network programs bandwidth

Click to apply the settings made

## Using Quick Connection

### Configuring the PPPoE connection settings

Before enabling the Network iControl's **Quick Connection** functions, you must configure the PPPoE connection settings

To configure the PPPoE settings:

1. Right-click  in the taskbar, and select **Open Network and Sharing Center**.

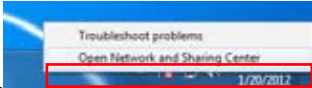

2. Right-click the PPPoE Connection, and select **Properties**.

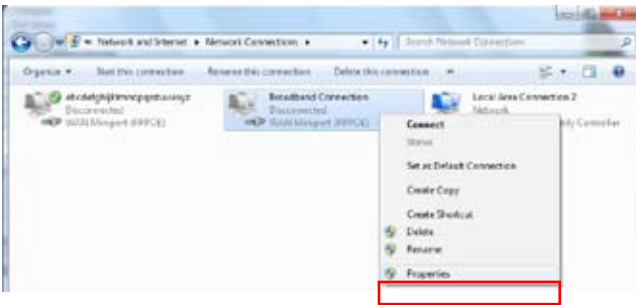

3. Click the **Options** tab, and deselect **Prompt for name and password, certificate, etc.** Click **OK** to complete the auto PPPoE connection settings.

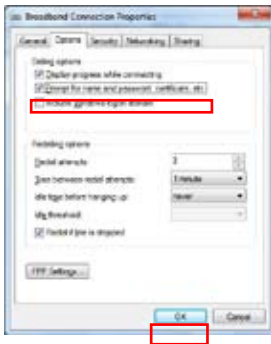

- You only need to configure the PPPoE connection settings once.
- Obtain the necessary information about your PPPoE connection from your network provider.

## Configuring the Quick Connection

To configure the auto-PPPoE connection:

1. Click the **Quick Connection** tab.
2. Tick **Automatically connect online anytime** option, then select the connection name in the **Connection Name** dropdown box.
3. Click **Apply** to enable PPPoE automatic network connection.





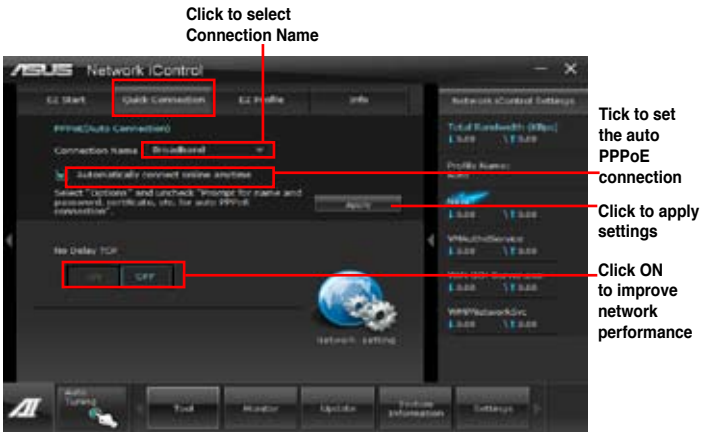

You can also enable the **No Delay TCP** function to help improve the network performance.



## Using EZ Profile

To use the EZ Profile:

EZ Profile allows you to load, edit, and save your own network program priority profile.

1. Click the **EZ Profile** tab. The programs are shown in the network program column.
2. Select the network program, and click  to create your profile.
3. Click  to save the changes and/or rename your profile.
4. Click , , or  to set the program priority as High, Normal, or Low.

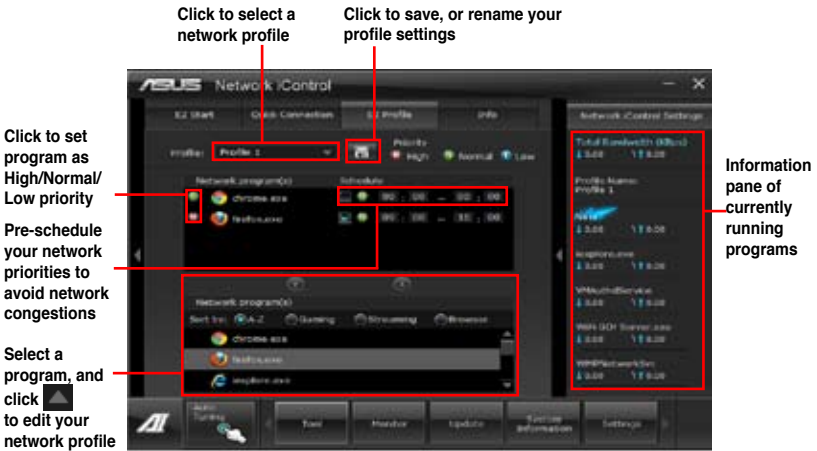

### 4.3.13 USB Charger+

This utility allows you to fast-charge your portable USB devices even if your PC is off, in Sleep Mode, or Hibernate Mode.



When you enable the ErP-ready option in the BIOS, the USB Charger+ will not operate under Sleep Mode, Hibernate Mode and Off mode.

### Launching the USB Charger+

To launch this utility, open the **AI Suite II**, then click **Tool > USB Charger+**.



\* The illustration above shows that no device connected to your PC for fast-charging.

### USB fast-charging mode settings

Click the dropdown box, and select a proper charge mode when your PC is off, in Sleep Mode, or Hibernate Mode.

- **Disable:** disables the USB fast-charging function.
- **ASUS:** fast-charges your connected ASUS devices.
- **Apple:** fast-charges your connected Apple devices.
- **Kindle:** fast-charges your Kindle devices.
- **Others:** charges other portable USB devices.



The utility cannot detect the devices connected to your computer if the charging mode is enabled.



## Setting up the charging function

When a portable device is connected to the USB port of the PC, the USB Charger+ automatically detects the kind of your device.

## Charging the device

Click  to fast-charge your device.



Clicking the  stops the charging of your connected device, and rescans for other detected devices. Click the  to re-enable the fast-charging.

## Disabling the charging function

Click  to stop charging your device.

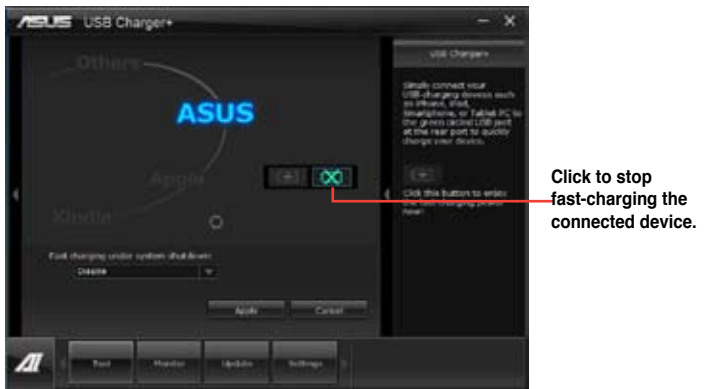

### 4.3.14 MyLogo2

This MyLogo utility lets you customize the boot logo. The boot logo is the image that appears on screen during the Power-On-Self-Tests (POST). Personalize your computer from the very beginning!

#### Launching ASUS Update

After installing AI Suite II from the motherboard support DVD, launch MyLogo by clicking **Update> MyLogo** on the AI Suite II main menu bar.



#### Using MyLogo

Select the way you would like to do update your boot logo. Then click Next and follow the given instructions.

##### Change the BIOS boot logo of my motherboard

1. Under Current BIOS, click **Browse** and choose the desired image for your boot logo. Then click on Next.





2. Click on **Auto Tune** to adjust image size compatibility or adjust the resolution bar.
3. You can click on Booting Preview to preview the boot image. Then click Next.
4. Click on Flash to start updating the image to the boot logo.
5. Click on Yes to reboot or you can also see the new logo next time you restart your computer.



### Change the boot logo of a downloaded BIOS file and update (or do not update) this BIOS to the motherboard

1. At BIOS File, **Browse** to download the requested BIOS file to your system. This utility will help you detect the compatibility of the BIOS version.
2. Then at Picture File, Browse to select the desired image for boot logo. Click Next.
3. Follow steps 2-5 in **Change the BIOS boot logo of my motherboard** to complete logo update.



The fullscreen logo application in BIOS utility must be enabled for MyLogo to take effect.

### 4.3.15 Audio configurations

The Realtek® audio CODEC provides 8-channel audio capability to deliver the ultimate audio experience on your computer. The software provides Jack-Sensing function, S/PDIF Out support, and interrupt capability. The CODEC also includes the Realtek® proprietary UAJ® (Universal Audio Jack) technology for all audio ports, eliminating cable connection errors, and giving users plug and play convenience.

Follow the installation wizard to install the Realtek® Audio Driver from the support DVD that came with the motherboard package.

If the Realtek audio software is correctly installed, you will find the **Realtek HD Audio Manager** icon on the taskbar. Double-click on the icon to display the Realtek HD Audio Manager.



Realtek HD Audio Manager

#### A. Realtek HD Audio Manager with DTS UltraPC II for Windows® 7™

Configuration option tabs (vary with the audio devices connected)



#### B. Realtek HD Audio Manager for Windows XP



- Refer to the software manual in the support DVD or visit the ASUS website at [www.asus.com](http://www.asus.com) for detailed software configuration.
- Due to Intel® Z77 platform does not support Windows® Vista™, Realtek HD Audio driver is only supported by Windows® 7™/Windows® XP™.
- To play Blu-Ray disc, make sure to use an HDCP compliant monitor.

## 4.4 RAID configurations

The motherboard supports the following SATA RAID solutions:

- **Intel® Rapid Storage Technology** with RAID 0, RAID 1, RAID 10 and RAID 5 support.
- **Maveil® RAID utility** with RAID 0 and RAID 1 support.



- You must install Windows® XP Service Pack 3 or later versions before using Serial ATA hard disk drives. The Serial ATA RAID feature is available only if you are using Windows® XP SP3 or later versions.
- Due to Windows® XP / Vista limitation, a RAID array with the total capacity over 2TB cannot be set as a boot disk. A RAID array over 2TB can only be set as a data disk only.
- If you want to install a Windows® operating system to a hard disk drive included in a RAID set, you have to create a RAID driver disk and load the RAID driver during OS installation. Refer to section **4.5 Creating a RAID driver disk** for details.

### 4.4.1 RAID definitions

**RAID 0 (Data striping)** optimizes two identical hard disk drives to read and write data in parallel, interleaved stacks. Two hard disks perform the same work as a single drive but at a sustained data transfer rate, double that of a single disk alone, thus improving data access and storage. Use of two new identical hard disk drives is required for this setup.

**RAID 1 (Data mirroring)** copies and maintains an identical image of data from one drive to a second drive. If one drive fails, the disk array management software directs all applications to the surviving drive as it contains a complete copy of the data in the other drive. This RAID configuration provides data protection and increases fault tolerance to the entire system. Use two new drives or use an existing drive and a new drive for this setup. The new drive must be of the same size or larger than the existing drive.

**RAID 5** stripes both data and parity information across three or more hard disk drives. Among the advantages of RAID 5 configuration include better HDD performance, fault tolerance, and higher storage capacity. The RAID 5 configuration is best suited for transaction processing, relational database applications, enterprise resource planning, and other business systems. Use a minimum of three identical hard disk drives for this setup.

**RAID 10** is data striping and data mirroring combined without parity (redundancy data) having to be calculated and written. With the RAID 10 configuration you get all the benefits of both RAID 0 and RAID 1 configurations. Use four new hard disk drives or use an existing drive and three new drives for this setup.

## 4.4.2 Installing Serial ATA hard disks

The motherboard supports Serial ATA hard disk drives. For optimal performance, install identical drives of the same model and capacity when creating a disk array.

To install the SATA hard disks for a RAID configuration:

1. Install the SATA hard disks into the drive bays.
2. Connect the SATA signal cables.
3. Connect a SATA power cable to the power connector on each drive.

## 4.4.3 Setting the RAID item in BIOS

You must enable the RAID function in the BIOS Setup before creating RAID set(s) using SATA HDDs. To do this:

1. Enter the BIOS Setup during POST.
2. Go to the **Advanced** menu > **SATA Configuration**, and then press <Enter>.
3. Set the **SATA Mode** item to [RAID Mode].
4. Save your changes, and then exit the BIOS Setup.



Refer to Chapter 3 for details on entering and navigating through the BIOS Setup.



Due to chipset limitation, when set any of SATA ports to RAID mode, all SATA ports run at RAID mode together.

## 4.4.4 Intel® Rapid Storage Technology Option ROM utility

To enter the Intel® Rapid Storage Technology Option ROM utility:

1. Turn on the system.
2. During POST, press <Ctrl> + <I> to display the utility main menu.

```
Intel(R) Rapid Storage Technology - Option ROM - v10.5.1.1070
Copyright(C) 2003-10 Intel Corporation. All Rights Reserved.

[ MAIN MENU ]
1. Create RAID Volume
2. Delete RAID Volume
3. Reset Disks to Non-RAID
4. Recovery Volume Options
5. Acceleration Options
6. Exit

[ DISK/VOLUME INFORMATION ]

RAID Volumes:
None defined.

Physical Devices:
Port Device Model      Serial #      Size  Type/Status (Vol ID)
0  ST3160812AS          9LS0HJA4    149.0GB Non-RAID Disk
1  ST3160812AS          9LS0F4HL    149.0GB Non-RAID Disk
2  ST3160812AS          3LS0JVL8    149.0GB Non-RAID Disk
3  ST3160812AS          9LS0BJ5H    149.0GB Non-RAID Disk

[↑↓]-Select      [ESC]-Exit      [ENTER]-Select Menu
```

The navigation keys at the bottom of the screen allow you to move through the menus and select the menu options.



The RAID BIOS setup screens shown in this section are for reference only and may not exactly match the items on your screen.



The utility supports maximum four hard disk drives for RAID configuration.

## Creating a RAID set

To create a RAID set:

1. From the utility main menu, select **1. Create RAID Volume** and press <Enter>. The following screen appears:

```
Intel(R) Rapid Storage Technology - Option ROM - v10.5.1.1070
Copyright(C) 2003-10 Intel Corporation. All Rights Reserved.

----- [ CREATE VOLUME MENU ] -----
Name: Volume0
RAID Level: RAID0(Stripe)
Disks: Select Disks
Strip Size: 128KB
Capacity: 0.0 GB
Sync: N/A
Create Volume

----- [ HELP ] -----

Enter a unique volume name that has no special characters and is
16 characters or less.

[↑↓]-Change [TAB]-Next [ESC]-Previous Menu [ENTER]-Select
```

2. Enter a name for the RAID set and press <Enter>.
3. When the **RAID Level** item is selected, press the up/down arrow key to select a RAID level to create, and then press <Enter>.
4. When the **Disks** item is selected, press <Enter> to select the hard disk drives you want to include in the RAID set. The **SELECT DISKS** screen appears:

```
----- [ SELECT DISKS ] -----
Port Drive Model Serial # Size Status
0 SMD11G081P2AS 9LS0/N/A 149.0GB Non-RAID Disk
1 ST3160812AS 9LS0F4HL 149.0GB Non-RAID Disk
2 ST3160812AS 3LS0JYL8 149.0GB Non-RAID Disk
3 ST3160812AS 9LS0BJ5H 149.0GB Non-RAID Disk

Select 2 to 6 disks to use in creating the volume.

[↑↓]-Prev/Next [SPACE]-SelectDisk [ENTER]-Done
```

5. Use the up/down arrow key to select a drive, and then press <Space> to select. A small triangle marks the selected drive. Press <Enter> after completing your selection.
6. Use the up/down arrow key to select the stripe size for the RAID array (for RAID 0, 10 and 5 only), and then press <Enter>. The available stripe size values range from 4KB to 128KB. The following are typical values:  
RAID 0: 128KB  
RAID 10: 64KB  
RAID 5: 64KB



---

We recommend a lower stripe size for server systems, and a higher stripe size for multimedia computer systems used mainly for audio and video editing.

---

7. When the **Capacity** item is selected, enter the RAID volume capacity that you want and press <Enter>. The default value indicates the maximum allowed capacity.
8. When the **Create Volume** item is selected, press <Enter>. The following warning message appears:

```
WARNING: ALL DATA ON SELECTED DISKS WILL BE LOST.  
Are you sure you want to create this volume? (Y/N):
```

9. Press <Y> to create the RAID volume and return to the main menu, or <N> to go back to the **CREATE VOLUME** menu.

## Deleting a RAID set



Take caution when deleting a RAID set. You will lose all data on the hard disk drives when you delete a RAID set.

To delete a RAID set:

1. From the utility main menu, select **2. Delete RAID Volume** and press <Enter>. The following screen appears:

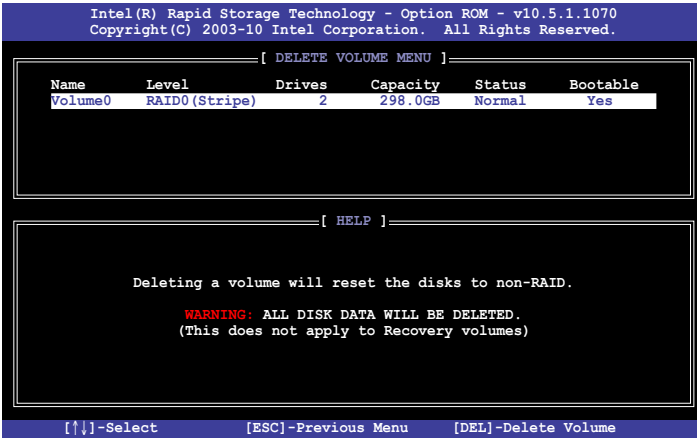

2. Use the up/down arrow key to select the RAID set you want to delete, and then press <Del>. The following warning message appears:

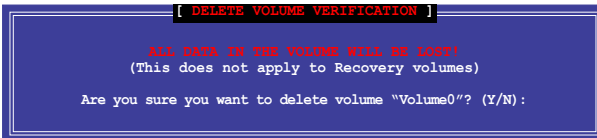

3. Press <Y> to delete the RAID set and return to the utility main menu, or press <N> to return to the **DELETE VOLUME** menu.

## Exiting the Intel® Rapid Storage Technology Option ROM utility

To exit the utility:

1. From the utility main menu, select **5. Exit**, and then press <Enter>. The following warning message appears:

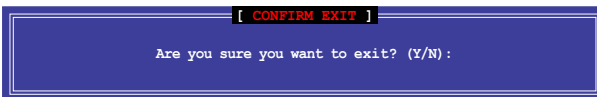

2. Press <Y> to exit or press <N> to return to the utility main menu.

## 4.4.5 Marvell RAID utility

The onboard Marvell SATA 6.0 Gb/s controller allows you to create a RAID 0 or RAID 1 array using two SATA hard disk drives. Refer to Chapter 2 of your motherboard user manual for the exact location of the Marvell SATA 6.0 Gb/s connector.

To enter the Marvell utility, press **<Ctrl> + <M>** during POST.



All existing data on the hard disk drives will be erased when creating or deleting a RAID array. Ensure that you have back up all your data in your hard disk drives before making any change to the drive status.

```
Marvell BIOS Setup (c) 2009 Marvell Technology Group Ltd.
-----
Topology                                Information
-----
HBA 0: Marvell 0                         Vendor ID      : 1B4B
  Virtual Disks                           Device ID     : 9130
  Free Physical Disks                     Revision ID   : B1
    PD 0: ST3160812AS                     BIOS Version  : 1.0.0.1028
    PD 8: ST3160812AS                     Firmware Version: 2.2.0.1105
                                           FCle Speed Rate : 5.0Gbps
                                           Configure SATA as: AHCI Mode

-----
Help
Marvell RAID on chip controller.
ENTER: Operation  F10: Exit/Save  ESC: Return
```

### Create a RAID Array

1. Move the selection bar to **HBA 0: Marvell 0** and press **<Enter>**.
2. Select **Configuration Wizard** and press **<Enter>**.

```
Marvell BIOS Setup (c) 2009 Marvell Technology Group Ltd.
-----
Configure->Select free disks
-----
HBA 0: Marvell 0                         Port ID       : 0
  Virtual Disks                           PD ID        : 0
  Free Physical Disks                     Type         : SATA PD
    * PD 0: ST3160812AS                    Status       : Unconfigured
    PD 8: ST3160812AS                    Size        : 152626MB
                                           Feature Support: MCQ 3G 48Bits
                                           Current Speed : 3G
                                           Model       : ST3160812AS
                                           Serial     : 9LS0F4HL
                                           FW Version  : 3.AAE

-----
Help
Use space bar to select the free disks to be used in the array.
ENTER: Operation  SPACE: Select  F10: Exit/Save  ESC: Return
```

3. Press **<Space>** to select the hard drives to be included in the RAID array. An asterisk (\*) appears in front of the selected hard drive. After selecting all the drives needed for the RAID array, press **<Enter>** to continue.



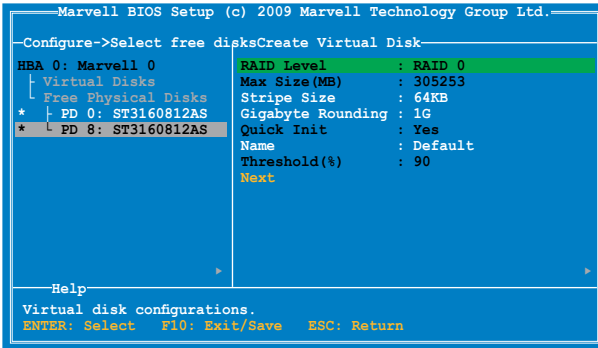

- Use the up or down arrow key to move the selection bar and press <Enter> to configure further RAID settings.

**RAID Level:** Select a RAID Level. Configuration options: [RAID 0] [RAID 1]

**Stripe Size:** Specifies the size of single data block on the virtual disk. In general, a larger stripe size is recommended for applications requiring large data transfers such as audio, video, and graphics. A smaller stripe size is better for applications with content in much smaller size, such as e-mails and documents.  
Configuration options: [32K] [64K]

**Gigabyte Rounding:** In the event of a single physical disk failure in a RAID 1 virtual disk, Gigabyte Rounding allows the replacement physical disk to be of a size slightly smaller than the existing physical disk. The capacity of the rebuilt virtual disk equals to the size of the smaller physical disk included in the RAID 1 array. The configuration options represent the tolerance value of drive capacity difference.  
Configuration options: [None] [1G] [10G]

**Name:** Enter a name with 1–10 letters (no special characters) for the RAID array.

- Move the selection bar to **Next** and press <Enter>. The following warning message appears:

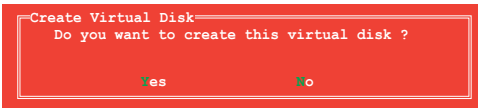

Press <Y> to create the RAID array, or press <N> to cancel. The new RAID array appears under Virtual Disks, as shown in the image below.

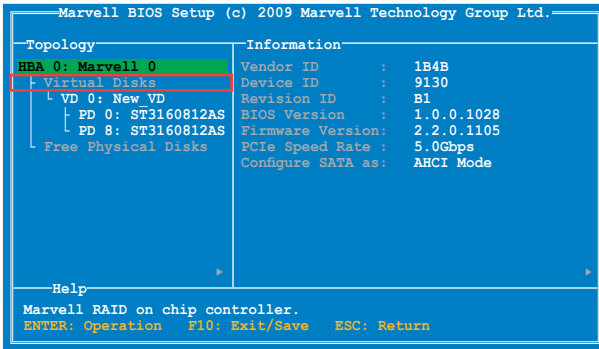

- Press <F10>. The following warning message appears:



Press <Y> to save the RAID setting and exit the Marvell RAID utility.

## Delete an existing RAID Array

- Select the RAID array to delete and press <Enter>. Select **Delete** and press <Enter>.

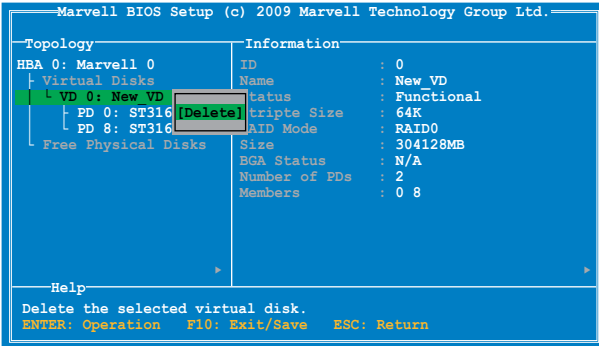

2. The following warning message appears:

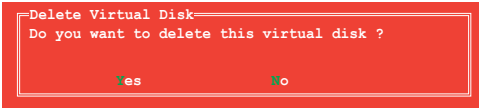

Press <Y> to delete the selected RAID array. The following warning message appears:



Press <Y> to delete the Master Boot Record (MBR) from the selected RAID array.

3. Press <F10>. The following warning message appears:



Press <Y> to save the RAID setting and exit the Marvell RAID utility.

## Intel® Smart Response Technology

Intel® Smart Response Technology boosts overall system performance. It uses an installed fast SSD (min 18.6GB available) as a cache for frequently accessed operations, speeding up hard drive/ main memory interaction. Key benefits are expedited hard drive speeds, reduced load and wait times, and maximized storage utilization. Power consumption also goes down by reducing unnecessary hard drive spin.



- Intel® Smart Response Technology supports Windows® 7/ Vista operating systems.
- Intel® Smart Response Technology is supported by 2nd generation Intel® Core™ processor family.
- Operating systems must be installed on the HDD to launch Intel® Smart Response Technology. The capacity of the SSD is reserved for caching function.
- Before applying Intel® Smart Response Technology, set the **SATA Mode BIOS** item to [RAID mode] in BIOS setup. Refer to section **3.5.4 SATA Configuration** for details.

To install Intel® Smart Response Technology:

1. Place the support DVD to the optical drive. The Drivers installation tab appears if your computer has enabled the Autorun feature.
2. Click the Drivers tab, then click Intel® Rapid Storage Technology Driver software.
3. Follow the onscreen instructions to complete installation.

To use Intel® Smart Response Technology:

1. Click **Accelerate** to launch Smart Response Technology settings.
  - a. Select the SSD you want to use to accelerate your storage system.
  - b. Select the size allocated for SSD caching.
  - c. Select which HDD for caching.
  - d. **Enhanced mode:**WRITE THROUGH, write to SSD and HDD at the same time.  
**Maximized mode:**WRITE BACK, write to SSD and write back to HDD in a later time.

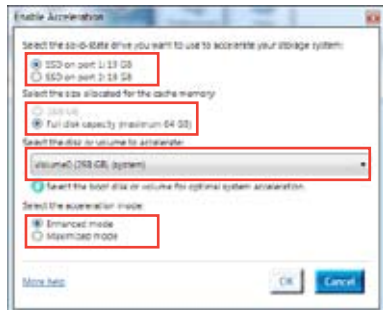

3. Select **Disable Acceleration** to disable this function and select **Change Mode** to switch acceleration mode to Enhanced/Maximus.



- Only Intel® internal SATA ports (gray and blue) support Intel® Smart Response Technology.
- You need at least one SSD (>18.6GB) and one HDD as a set to enable Intel® Smart Response Technology. A single SSD can only be assigned to one HDD for caching.
- The maximum caching size on the SSD is 64GB. If the SSD exceeds 64GB, storage capacity left out of caching can still be identified by the system for normal storage.
- Be sure to disable the acceleration function of Intel® Smart Response Technology under OS when applying the actions below:
  - Removing or replacing the SSD
  - Updating IRST 10.5 driver
  - Updating BIOS
- If you want to restore the OS, go to BIOS Option ROM utility and select Acceleration Options to disable Intel® Smart Response Technology.
- The performance of Intel® Smart Response Technology varies by SSD.

## 4.5 Creating a RAID driver disk

A floppy disk with the RAID driver is required when installing a Windows® operating system on a hard disk drive that is included in a RAID set.



- **The motherboard does not provide a floppy drive connector.** You have to use a USB floppy disk drive when creating a **SATA RAID** driver disk.
- Windows® XP may not recognize the USB floppy disk drive due to Windows® XP limitation. To work around this OS limitation, refer to section **4.5.4 Using a USB floppy disk drive**.

### 4.5.1 Creating a RAID driver disk without entering the OS

To create a RAID driver disk without entering the OS:

1. Boot your computer.
2. Press <Del> during POST to enter the BIOS setup utility.
3. Set the optical drive as the primary boot device.
4. Insert the support DVD into the optical drive.
5. Save changes and exit BIOS.
6. When the **Make Disk** menu appears, press <1> to create a RAID driver disk.
7. Insert a formatted floppy disk into the USB floppy disk drive, then press <Enter>.
8. Follow the succeeding screen instructions to complete the process.

### 4.5.2 Creating a RAID driver disk in Windows®

To create a RAID driver disk in Windows®:

1. Start Windows®.
2. Plug the USB floppy disk drive and insert a floppy disk.
3. Place the motherboard support DVD into the optical drive.
4. Go to the **Make Disk** menu, and then click **Intel AHCI/RAID Driver Disk** to create a RAID driver disk.
5. Select USB floppy disk drive as the destination disk.
6. Follow the succeeding screen instructions to complete the process.



Write-protect the floppy disk to avoid a computer virus infection.

### 4.5.3 Installing the RAID driver during Windows® OS installation

To install the RAID driver in Windows® XP:

1. During the OS installation, the system prompts you to press the F6 key to install third-party SCSI or RAID driver.
2. Press <F6>, and then insert the floppy disk with RAID driver into the USB floppy disk drive.
3. When prompted to select the SCSI adapter to install, select the RAID driver for the corresponding OS version.
4. Follow the succeeding screen instructions to complete the installation.

To install the RAID driver for Windows® Vista or later OS:

1. During the OS installation, click **Load Driver** to allow you to select the installation media containing the RAID driver.
2. Insert the USB flash drive with RAID driver into the USB port or the support DVD into the optical drive, and then click **Browse**.
3. Click the name of the device you've inserted, go to **Drivers > RAID**, and then select the RAID driver for the corresponding OS version. Click **OK**.
4. Follow the succeeding screen instructions to complete the installation.



---

Before loading the RAID driver from a USB flash drive, you have to use another computer to copy the RAID driver from the support DVD to the USB flash drive.

---

## 4.5.4 Using a USB floppy disk drive

Due to OS limitation, Windows® XP may not recognize the USB floppy disk drive when you install the RAID driver from a floppy disk during the OS installation.

To solve this issue, add the USB floppy disk drive's Vendor ID (VID) and Product ID (PID) to the floppy disk containing the RAID driver. Refer to the steps below:

1. Using another computer, plug the USB floppy disk drive, and insert the floppy disk containing the RAID driver.
2. Right-click **My Computer** on the Windows® desktop or **start** menu, and then select **Manage** from the pop-up window.

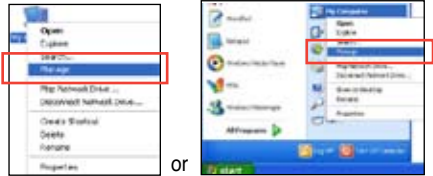

3. Select **Device Manager**. From the **Universal Serial Bus controllers**, right-click **xxxxxx USB Floppy**, and then select **Properties** from the pop-up window.

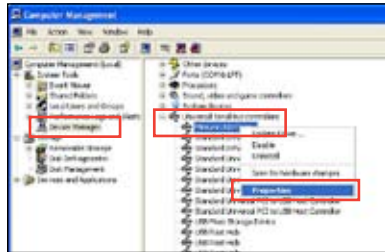

The name of the USB floppy disk drive varies with different vendors.

4. Click **Details** tab. The Vendor ID (VID) and Product ID (PID) are displayed.

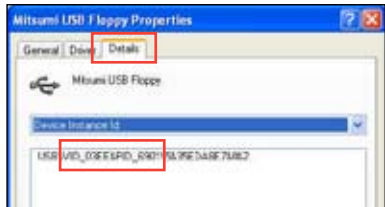

5. Browse the contents of the RAID driver disk to locate the file **txtsetup.oem**.
6. Double-click the file. A window appears, allowing you to select the program for opening the oem file.

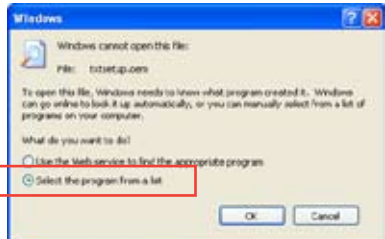



7. Use Notepad to open the file.



8. Find the `[HardwareIds.scsi.iaAHCI_DesktopWorkstationServer]` and `[HardwareIds.scsi.iaStor_DesktopWorkstationServer]` sections in the `txtsetup.oem` file.
9. Type the following line to the bottom of the two sections:  
`id = "USB\VID_xxxx&PID_xxxx", "usbstor"`

```
[HardwareIds.scsi.iaAHCI_DesktopWorkstationServer]
id= "PCI\VEN_8086&DEV_1C02&CC_0106", "iaStor"
id= "USB\VID_03EE&PID_6901", "usbstor"

[HardwareIds.scsi.iaStor_DesktopWorkstationServer]
id= "PCI\VEN_8086&DEV_2822&CC_0104", "iaStor"
id= "USB\VID_03EE&PID_6901", "usbstor"
```



\_\_\_\_\_

\_\_\_\_\_

Add the same line to both sections.



\_\_\_\_\_

\_\_\_\_\_

The VID and PID vary with different vendors.

10. Save and exit the file.



# Chapter 5

## 5.1 AMD® CrossFireX™ technology

The motherboard supports the AMD® CrossFireX™ technology that allows you to install multi-graphics processing units (GPU) graphics cards. Follow the installation procedures in this section.

### 5.1.1 Requirements

- In Dual CrossFireX mode, you should have two identical CrossFireX-ready graphics cards or one CrossFireX-ready dual-GPU graphics card that are AMD® certified.
- Ensure that your graphics card driver supports the AMD CrossFireX technology. Download the latest driver from the AMD website ([www.amd.com](http://www.amd.com)).
- Ensure that your power supply unit (PSU) can provide at least the minimum power required by your system. See Chapter 2 for details.



- 
- We recommend that you install additional chassis fans for better thermal environment.
  - Visit the AMD Game website (<http://game.amd.com>) for the latest certified graphics card and the supported 3D application list.
- 

### 5.1.2 Before you begin

For AMD CrossFireX to work properly, you have to uninstall all existing graphics card drivers before installing AMD CrossFireX graphics cards to your system.

To uninstall existing graphics card drivers:

1. Close all current applications.
2. For Windows XP, go to **Control Panel > Add/Remove Programs**.  
For Windows Vista, go to **Control Panel > Programs and Features**.
3. Select your current graphics card driver/s.
4. For Windows XP, select **Add/Remove**.  
For Windows Vista, select **Uninstall**.
5. Turn off your computer.

### 5.1.3 Installing two CrossFireX™ graphics cards



The following pictures are for reference only. The graphics cards and the motherboard layout may vary with models, but the installation steps remain the same.

1. Prepare two CrossFireX-ready graphics cards.
2. Insert the two graphics card into the PCIEX16 slots. If your motherboard has more than two PCIEX16 slots, refer to Chapter 2 in this user manual for the locations of the PCIEX16 slots recommended for multi-graphics card installation.



4. Align and firmly insert the CrossFireX bridge connector to the goldfingers on each graphics card. Ensure that the connector is firmly in place.

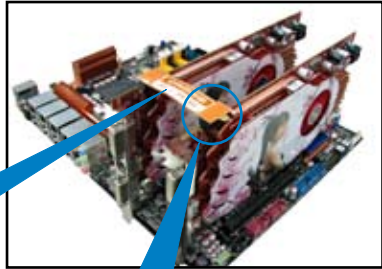

CrossFireX bridge  
(bundled with  
graphics cards)

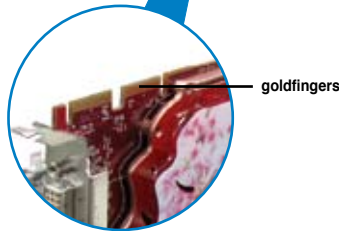

5. Connect two independent auxiliary power sources from the power supply to the two graphics cards separately.
6. Connect a VGA or a DVI cable to the graphics card.

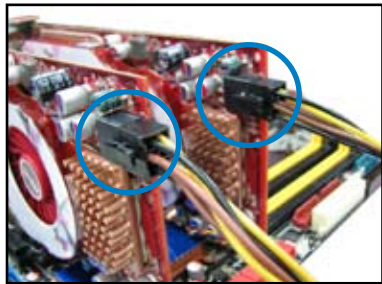

### 5.1.4 Installing the device drivers

Refer to the documentation that came with your graphics card package to install the device drivers.



Ensure that your PCI Express graphics card driver supports the AMD® CrossFireX™ technology. Download the latest driver from the AMD website (www.amd.com).

### 5.1.5 Enabling the AMD® CrossFireX™ technology

After installing your graphics cards and the device drivers, enable the CrossFireX™ feature through the AMD Catalyst™ Control Center in Windows environment.

#### Launching the AMD VISION Engine Control Center

To launch the AMD VISION Engine Control Center:

1. Right-click on the Windows® desktop and select **AMD VISION Engine Control Center**. You can also right-click the AMD icon in the Windows notification area and select **Vision Engine Control Center**.

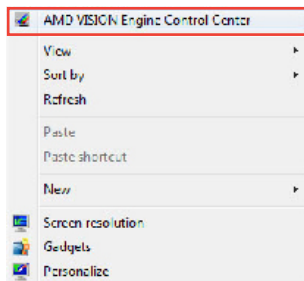

2. The **VISION Engine Control Center Setup Assistant** appears when the system detects the existence of multi-graphics cards. Click **Go** to continue to the **VISION Engine Control Center Advanced View** window.



#### Enabling Dual CrossFireX technology

1. In the Catalyst Control Center window, click **Graphics Settings > Performance > AMD CrossFireX™ Configuration**.
2. From the Graphics Adapter list, select the graphics card to act as the display GPU.
3. Select **Enable CrossFireX™**.
4. Click **Apply**, and then click **OK** to exit the window.

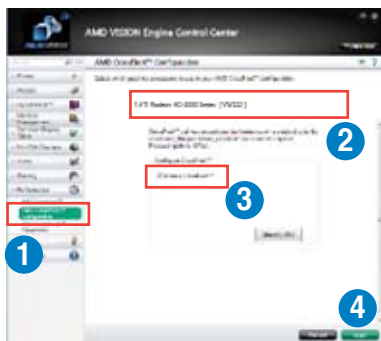

## 5.2 NVIDIA® SLI™ technology

The motherboard supports the NVIDIA® SLI™ (Scalable Link Interface) technology that allows you to install multi-graphics processing units (GPU) graphics cards. Follow the installation procedures in this section.

### 5.2.1 Requirements

- In Dual SLI mode, you should have two identical SLI-ready graphics cards that are NVIDIA® certified.
- In Triple SLI mode, you should have three identical SLI-ready graphics cards that are NVIDIA® certified.
- In Quad SLI mode, you should have four identical SLI-ready graphics cards that are NVIDIA® certified.
- Ensure that your graphics card driver supports the NVIDIA SLI technology. Download the latest driver from the NVIDIA website ([www.nvidia.com](http://www.nvidia.com)).
- Ensure that your power supply unit (PSU) can provide at least the minimum power required by your system. See Chapter 2 for details.



- 
- We recommend that you install additional chassis fans for better thermal environment.
  - Visit the NVIDIA zone website (<http://www.nzone.com>) for the latest certified graphics card and supported 3D application list.
- 

### 5.2.2 Installing two SLI-ready graphics cards



The following pictures are for reference only. The graphics cards and the motherboard layout may vary with models, but the installation steps remain the same.

1. Prepare two SLI-ready graphics cards.
2. Insert the two graphics card into the PCIEX16 slots. If your motherboard has more than two PCIEX16 slots, refer to Chapter 2 in this user manual for the locations of the PCIEX16 slots recommended for multi-graphics card installation.
3. Ensure that the cards are properly seated on the slots.

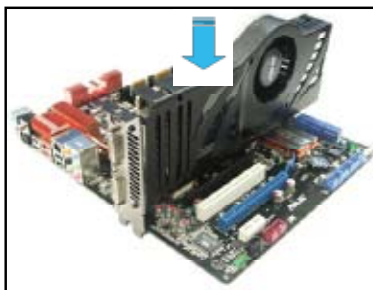

4. Align and firmly insert the SLI bridge connector to the goldfingers on each graphics card. Ensure that the connector is firmly in place.
5. Connect two independent auxiliary power sources from the power supply to the two graphics cards separately.

6. Connect a VGA or a DVI cable to the graphics card.

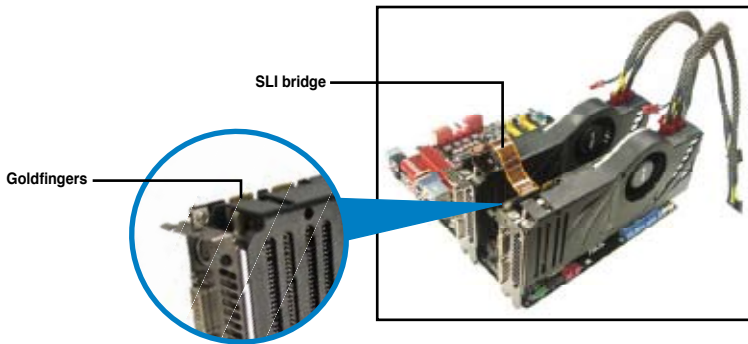

### 5.2.3 Installing three SLI-ready graphics cards

1. Prepare three SLI-ready graphics cards.
2. Insert the three graphics card into the PCIEX16 slots. If your motherboard has more than two PCIEX16 slots, refer to Chapter 2 in this user manual for the locations of the PCIEX16 slots recommended for multi-graphics card installation.
3. Ensure that the cards are properly seated on the slots.
4. Align and firmly insert the 3-Way SLI bridge connector to the goldfingers on each graphics card. Ensure that the connector is firmly in place.
5. Connect three independent auxiliary power sources from the power supply to the three graphics cards separately.
6. Connect a VGA or a DVI cable to the graphics card.

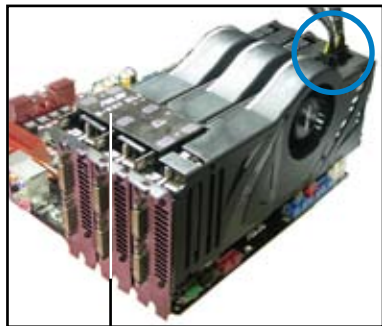
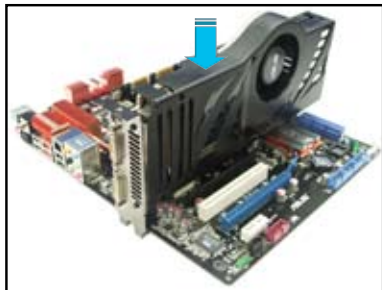

3-Way SLI bridge

## 5.2.4 Installing four SLI-ready graphics cards

1. Prepare four SLI-ready graphics cards.
2. Insert the four graphics card into the PCIEX16 slots. If your motherboard has more than two PCIEX16 slots, refer to Chapter 2 in this user manual for the locations of the PCIEX16 slots recommended for multi-graphics card installation.
3. Ensure that the cards are properly seated on the slots.
4. Align and firmly insert the 4-Way SLI bridge connector to the goldfingers on each graphics card. Ensure that the connector is firmly in place.
5. Connect four independent auxiliary power sources from the power supply to the four graphics cards separately.
6. Connect a VGA or a DVI cable to the graphics card.

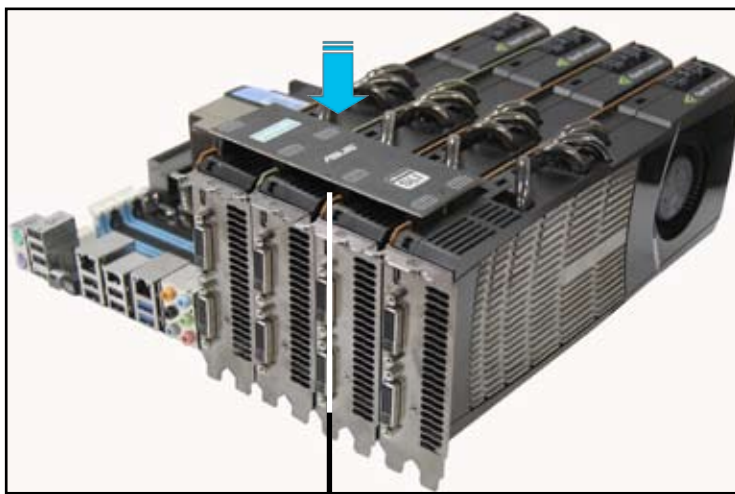

4-Way SLI bridge



### 5.2.3 Installing the device drivers

Refer to the documentation that came with your graphics card package to install the device drivers.



Ensure that your PCI Express graphics card driver supports the NVIDIA® SLI™ technology. Download the latest driver from the NVIDIA website ([www.nvidia.com](http://www.nvidia.com)).

### 5.2.4 Enabling the NVIDIA® SLI™ technology

After installing your graphics cards and the device drivers, enable the SLI feature in NVIDIA® Control Panel under the Windows® Vista™ operating system.

#### Launching the NVIDIA Control Panel

You can launch the NVIDIA Control Panel by the following two methods.

- A. Right click on the empty space of the Windows® desktop and select **NVIDIA Control Panel**.

The NVIDIA Control Panel window appears (See Step B5).

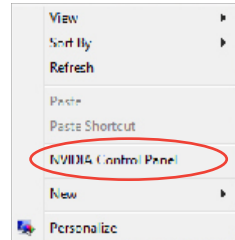

- B1. If you cannot see the NVIDIA Control Panel item in step (A), select **Personalize**.

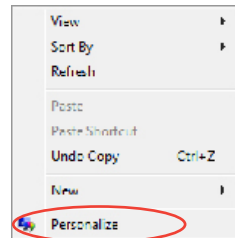

- B2. From the **Personalization** window, select **Display Settings**.



- B2. From the **Personalization** window, select **Display Settings**.



- B4. Select the NVIDIA GeForce tab, and then click **Start the NVIDIA Control Panel**.



- B5. The NVIDIA Control Panel window appears.



## Enabling SLI settings

From the NVIDIA Control Panel window, select **Set SLI Configuration**. Click **Enable SLI** and set the display for viewing SLI rendered content. When done, click **Apply**.

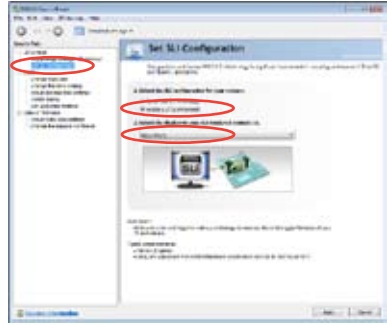

## 5.3 LucidLogix® Virtu™ solution

LucidLogix® Virtu™ is a new generation GPU virtualization software that blurs the line between embedded graphics and discrete GPU for increased graphics performance. Its GPU virtualization dynamically assigns tasks to the best available graphics resources based on power, performance and system load. It allows users to fully utilize the unique capabilities of advanced Sandy Bridge multimedia features alongside the high end 3D rendering performance provided by installed graphics cards. For users with diverse needs, LucidLogix® Virtu™ GPU virtualization provides great flexibility and efficiency.



- LucidLogix® Virtu™ supports Windows® 7 operating systems.
- Intel® Quick Sync Video feature is supported by 2nd generation Intel® Core™ processor family.
- iGPU Multi-Monitor support option has to be enabled in BIOS before installing LucidLogix® Virtu™.
- Supports NVIDIA® GF4xx/ 5xx series & AMD® HD5xxx/ 6xxx series graphic cards.

### 5.3.1 Hardware installAMDOn

To install LucidLogix® Virtu™:

1. Place the support DVD to the optical drive. The Drivers installation tab appears if your computer has enabled the Autorun feature.
2. Click the Drivers tab, then click LucidLogix® Virtu™ software.
3. Follow the onscreen instructions to complete installation.

#### i-Mode

To use LucidLogix® Virtu™ solution in i-Mode, display must be always connected to Sandy Bridge motherboard video output.



Be sure to set Initial Graphic Adaptor to iGPU in BIOS to activate i-Mode support.

#### d-Mode (recommended mode)

To use LucidLogix® Virtu™ solution in d-Mode, display must be connected to the discrete GPU installed in the system.



Be sure to set Initial Graphic Adaptor to PCIE or PCIE/ PCI in BIOS to enable d-Mode support.

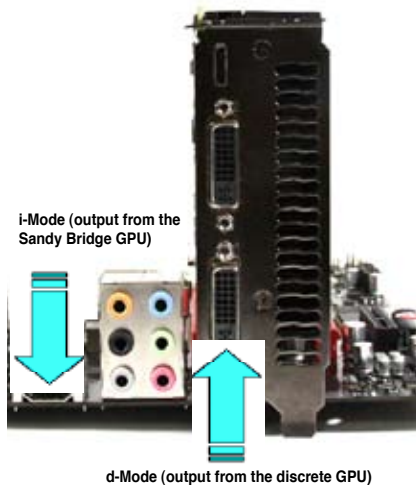

Both i-Mode and d-Mode enjoy the performance of Intel® Sandy Bridge built-in media features and discrete card. d-Mode is recommended for enhanced 3D gaming performance.

### 5.3.2 Software configuration

After you successfully installed the LucidLogix® Virtu™ from the support DVD that comes with your motherboard package, a LucidLogix® Virtu™ icon appears in the notification area.

To enable LucidLogix® Virtu™

1. Right-click LucidLogix® Virtu™ icon in the notification area and select **Enable Virtu**.
2. LucidLogix® Virtu™ is enabled.

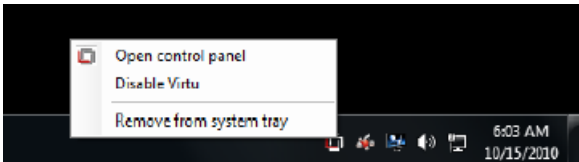
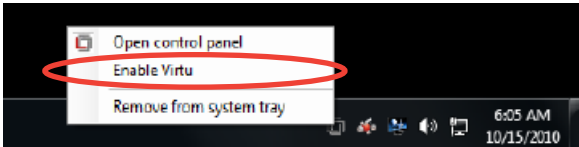

---

LucidLogix® Virtu™ is automatically activated when your system is powered on. Select **Remove from system tray**, if you want to remove LucidLogix® Virtu™.

---

To open the control panel

1. Right-click LucidLogix® Virtu™ icon in the notification area and select **Open control panel**.
2. In the Main tab, you can check the LucidLogix® Virtu™ status and customize your settings.

Check your current display mode, i-mode (blue) or d-Mode (green)



Adjust Performance optimization,  
Quality over Performance or  
Performance over Quality

Select the way to show the Lucid  
icon when you are in game.

## **ASUS contact information**

### **ASUSTeK COMPUTER INC.**

Address 15 Li-Te Road, Peitou, Taipei, Taiwan 11259  
Telephone +886-2-2894-3447  
Fax +886-2-2890-7798  
E-mail info@asus.com.tw  
Web site www.asus.com.tw

#### ***Technical Support***

Telephone +86-21-38429911  
Online support support.asus.com

### **ASUS COMPUTER INTERNATIONAL (America)**

Address 800 Corporate Way, Fremont, CA 94539, USA  
Telephone +1-812-282-3777  
Fax +1-510-608-4555  
Web site usa.asus.com

#### ***Technical Support***

Telephone +1-812-282-2787  
Support fax +1-812-284-0883  
Online support support.asus.com

### **ASUS COMPUTER GmbH (Germany and Austria)**

Address Harkort Str. 21-23, D-40880 Ratingen, Germany  
Fax +49-2102-959911  
Web site www.asus.de  
Online contact www.asus.de/sales

#### ***Technical Support***

Telephone +49-1805-010923\*  
Support Fax +49-2102-9599-11  
Online support support.asus.com

\* EUR 0.14/minute from a German fixed landline; EUR 0.42/minute from a mobile phone.

# DECLARATION OF CONFORMITY

Per FCC Part 2 Section 2.1077(e)



**Responsible Party Name:** Asus Computer International

**Address:** 800 Corporate Way, Fremont, CA 94539.

**Phone/Fax No:** (510)739-3777/(510)668-4555

hereby declares that the product

**Product Name :** Motherboard

**Model Number :** P8Z77 WS

Conforms to the following specifications:

- FCC Part 15, Subpart B, Unintentional Radiators
- FCC Part 15, Subpart C, Intentional Radiators
- FCC Part 15, Subpart E, Intentional Radiators

#### Supplementary Information:

This device complies with part 15 of the FCC Rules. Operation is subject to the following two conditions: (1) This device may not cause harmful interference, and (2) this device must accept any interference received, including interference that may cause undesired operation.

Representative Person's Name : Steve Chang, President

Signature : Steve Chang

Date : Feb. 29, 2012

Ver 110101

# EC Declaration of Conformity



We, the undersigned,

Manufacturer:	ASUS INC., COMPUTER INC.
Address, City:	No. 106, LITE RD., PEITOH, TAIPEI 112, TAIWAN R.O.C.
Country:	TAIWAN
Authorized representative in Europe:	ASUS COMPUTER GmbH
Address, City:	HARDROTT STR. 21-23, 40880 NÜRNBERG
Country:	GERMANY

declare the following apparatus:

Product name :	Motherboard
Model name :	P8Z77 WS

conform with the essential requirements of the following directives:

<input checked="" type="checkbox"/> <b>2002/95/EC RoHS Directive</b>	<input type="checkbox"/> EN 61243-1	<input type="checkbox"/> EN 61243-2	<input type="checkbox"/> EN 61243-3	<input type="checkbox"/> EN 61243-4	<input type="checkbox"/> EN 61243-5	<input type="checkbox"/> EN 61243-6	<input type="checkbox"/> EN 61243-7	<input type="checkbox"/> EN 61243-8	<input type="checkbox"/> EN 61243-9	<input type="checkbox"/> EN 61243-10	<input type="checkbox"/> EN 61243-11	<input type="checkbox"/> EN 61243-12	<input type="checkbox"/> EN 61243-13	<input type="checkbox"/> EN 61243-14	<input type="checkbox"/> EN 61243-15	<input type="checkbox"/> EN 61243-16	<input type="checkbox"/> EN 61243-17	<input type="checkbox"/> EN 61243-18	<input type="checkbox"/> EN 61243-19	<input type="checkbox"/> EN 61243-20	<input type="checkbox"/> EN 61243-21	<input type="checkbox"/> EN 61243-22	<input type="checkbox"/> EN 61243-23	<input type="checkbox"/> EN 61243-24	<input type="checkbox"/> EN 61243-25	<input type="checkbox"/> EN 61243-26	<input type="checkbox"/> EN 61243-27	<input type="checkbox"/> EN 61243-28	<input type="checkbox"/> EN 61243-29	<input type="checkbox"/> EN 61243-30	<input type="checkbox"/> EN 61243-31	<input type="checkbox"/> EN 61243-32	<input type="checkbox"/> EN 61243-33	<input type="checkbox"/> EN 61243-34	<input type="checkbox"/> EN 61243-35	<input type="checkbox"/> EN 61243-36	<input type="checkbox"/> EN 61243-37	<input type="checkbox"/> EN 61243-38	<input type="checkbox"/> EN 61243-39	<input type="checkbox"/> EN 61243-40	<input type="checkbox"/> EN 61243-41	<input type="checkbox"/> EN 61243-42	<input type="checkbox"/> EN 61243-43	<input type="checkbox"/> EN 61243-44	<input type="checkbox"/> EN 61243-45	<input type="checkbox"/> EN 61243-46	<input type="checkbox"/> EN 61243-47	<input type="checkbox"/> EN 61243-48	<input type="checkbox"/> EN 61243-49	<input type="checkbox"/> EN 61243-50	<input type="checkbox"/> EN 61243-51	<input type="checkbox"/> EN 61243-52	<input type="checkbox"/> EN 61243-53	<input type="checkbox"/> EN 61243-54	<input type="checkbox"/> EN 61243-55	<input type="checkbox"/> EN 61243-56	<input type="checkbox"/> EN 61243-57	<input type="checkbox"/> EN 61243-58	<input type="checkbox"/> EN 61243-59	<input type="checkbox"/> EN 61243-60	<input type="checkbox"/> EN 61243-61	<input type="checkbox"/> EN 61243-62	<input type="checkbox"/> EN 61243-63	<input type="checkbox"/> EN 61243-64	<input type="checkbox"/> EN 61243-65	<input type="checkbox"/> EN 61243-66	<input type="checkbox"/> EN 61243-67	<input type="checkbox"/> EN 61243-68	<input type="checkbox"/> EN 61243-69	<input type="checkbox"/> EN 61243-70	<input type="checkbox"/> EN 61243-71	<input type="checkbox"/> EN 61243-72	<input type="checkbox"/> EN 61243-73	<input type="checkbox"/> EN 61243-74	<input type="checkbox"/> EN 61243-75	<input type="checkbox"/> EN 61243-76	<input type="checkbox"/> EN 61243-77	<input type="checkbox"/> EN 61243-78	<input type="checkbox"/> EN 61243-79	<input type="checkbox"/> EN 61243-80	<input type="checkbox"/> EN 61243-81	<input type="checkbox"/> EN 61243-82	<input type="checkbox"/> EN 61243-83	<input type="checkbox"/> EN 61243-84	<input type="checkbox"/> EN 61243-85	<input type="checkbox"/> EN 61243-86	<input type="checkbox"/> EN 61243-87	<input type="checkbox"/> EN 61243-88	<input type="checkbox"/> EN 61243-89	<input type="checkbox"/> EN 61243-90	<input type="checkbox"/> EN 61243-91	<input type="checkbox"/> EN 61243-92	<input type="checkbox"/> EN 61243-93	<input type="checkbox"/> EN 61243-94	<input type="checkbox"/> EN 61243-95	<input type="checkbox"/> EN 61243-96	<input type="checkbox"/> EN 61243-97	<input type="checkbox"/> EN 61243-98	<input type="checkbox"/> EN 61243-99	<input type="checkbox"/> EN 61243-100
--	-------------------------------------	-------------------------------------	-------------------------------------	-------------------------------------	-------------------------------------	-------------------------------------	-------------------------------------	-------------------------------------	-------------------------------------	--------------------------------------	--------------------------------------	--------------------------------------	--------------------------------------	--------------------------------------	--------------------------------------	--------------------------------------	--------------------------------------	--------------------------------------	--------------------------------------	--------------------------------------	--------------------------------------	--------------------------------------	--------------------------------------	--------------------------------------	--------------------------------------	--------------------------------------	--------------------------------------	--------------------------------------	--------------------------------------	--------------------------------------	--------------------------------------	--------------------------------------	--------------------------------------	--------------------------------------	--------------------------------------	--------------------------------------	--------------------------------------	--------------------------------------	--------------------------------------	--------------------------------------	--------------------------------------	--------------------------------------	--------------------------------------	--------------------------------------	--------------------------------------	--------------------------------------	--------------------------------------	--------------------------------------	--------------------------------------	--------------------------------------	--------------------------------------	--------------------------------------	--------------------------------------	--------------------------------------	--------------------------------------	--------------------------------------	--------------------------------------	--------------------------------------	--------------------------------------	--------------------------------------	--------------------------------------	--------------------------------------	--------------------------------------	--------------------------------------	--------------------------------------	--------------------------------------	--------------------------------------	--------------------------------------	--------------------------------------	--------------------------------------	--------------------------------------	--------------------------------------	--------------------------------------	--------------------------------------	--------------------------------------	--------------------------------------	--------------------------------------	--------------------------------------	--------------------------------------	--------------------------------------	--------------------------------------	--------------------------------------	--------------------------------------	--------------------------------------	--------------------------------------	--------------------------------------	--------------------------------------	--------------------------------------	--------------------------------------	--------------------------------------	--------------------------------------	--------------------------------------	--------------------------------------	--------------------------------------	--------------------------------------	--------------------------------------	--------------------------------------	--------------------------------------	--------------------------------------	---------------------------------------



Position : CEO  
Name : Steve Chang

Signature : Steve Chang

Declaration Date: Feb. 29, 2012  
Year to begin affixing CE marking: 2012

Ver 110101