

**MAXIMUS VII
IMPACT**

ASUS[®]

Motherboard

E9439
First Edition
July 2014

Copyright © 2013 ASUSTeK COMPUTER INC. All Rights Reserved.

No part of this manual, including the products and software described in it, may be reproduced, transmitted, transcribed, stored in a retrieval system, or translated into any language in any form or by any means, except documentation kept by the purchaser for backup purposes, without the express written permission of ASUSTeK COMPUTER INC. ("ASUS").

Product warranty or service will not be extended if: (1) the product is repaired, modified or altered, unless such repair, modification of alteration is authorized in writing by ASUS; or (2) the serial number of the product is defaced or missing.

ASUS PROVIDES THIS MANUAL "AS IS" WITHOUT WARRANTY OF ANY KIND, EITHER EXPRESS OR IMPLIED, INCLUDING BUT NOT LIMITED TO THE IMPLIED WARRANTIES OR CONDITIONS OF MERCHANTABILITY OR FITNESS FOR A PARTICULAR PURPOSE. IN NO EVENT SHALL ASUS, ITS DIRECTORS, OFFICERS, EMPLOYEES OR AGENTS BE LIABLE FOR ANY INDIRECT, SPECIAL, INCIDENTAL, OR CONSEQUENTIAL DAMAGES (INCLUDING DAMAGES FOR LOSS OF PROFITS, LOSS OF BUSINESS, LOSS OF USE OR DATA, INTERRUPTION OF BUSINESS AND THE LIKE), EVEN IF ASUS HAS BEEN ADVISED OF THE POSSIBILITY OF SUCH DAMAGES ARISING FROM ANY DEFECT OR ERROR IN THIS MANUAL OR PRODUCT.

SPECIFICATIONS AND INFORMATION CONTAINED IN THIS MANUAL ARE FURNISHED FOR INFORMATIONAL USE ONLY, AND ARE SUBJECT TO CHANGE AT ANY TIME WITHOUT NOTICE, AND SHOULD NOT BE CONSTRUED AS A COMMITMENT BY ASUS. ASUS ASSUMES NO RESPONSIBILITY OR LIABILITY FOR ANY ERRORS OR INACCURACIES THAT MAY APPEAR IN THIS MANUAL, INCLUDING THE PRODUCTS AND SOFTWARE DESCRIBED IN IT.

Products and corporate names appearing in this manual may or may not be registered trademarks or copyrights of their respective companies, and are used only for identification or explanation and to the owners' benefit, without intent to infringe.

Offer to Provide Source Code of Certain Software

This product contains copyrighted software that is licensed under the General Public License ("GPL"), under the Lesser General Public License Version ("LGPL") and/or other Free Open Source Software Licenses. Such software in this product is distributed without any warranty to the extent permitted by the applicable law. Copies of these licenses are included in this product.

Where the applicable license entitles you to the source code of such software and/or other additional data, you may obtain it for a period of three years after our last shipment of the product, either

(1) for free by downloading it from <http://support.asus.com/download>

or

(2) for the cost of reproduction and shipment, which is dependent on the preferred carrier and the location where you want to have it shipped to, by sending a request to:

ASUSTeK Computer Inc.
Legal Compliance Dept.
15 Li Te Rd.,
Beitou, Taipei 112
Taiwan

In your request please provide the name, model number and version, as stated in the About Box of the product for which you wish to obtain the corresponding source code and your contact details so that we can coordinate the terms and cost of shipment with you.

The source code will be distributed WITHOUT ANY WARRANTY and licensed under the same license as the corresponding binary/object code.

This offer is valid to anyone in receipt of this information.

ASUSTeK is eager to duly provide complete source code as required under various Free Open Source Software licenses. If however you encounter any problems in obtaining the full corresponding source code we would be much obliged if you give us a notification to the email address gpl@asus.com, stating the product and describing the problem (please DO NOT send large attachments such as source code archives, etc. to this email address).

Contents

Safety information.....	vii
About this guide.....	viii
MAXIMUS VII IMPACT specifications summary	x
Package contents.....	xiv
Installation tools and components.....	xv

Chapter 1: Product Introduction

1.1	Special features.....	1-1
1.1.1	Product highlights.....	1-1
1.1.2	ROG Gaming Features	1-2
1.1.3	ROG Exclusive Features.....	1-3
1.1.4	ASUS Special Features	1-4
1.1.5	ROG rich bundled software.....	1-5
1.2	Motherboard overview.....	1-6
1.2.1	Before you proceed.....	1-6
1.2.2	Motherboard layout.....	1-7
1.2.3	Central Processing Unit (CPU)	1-9
1.2.4	System memory	1-10
1.2.5	Expansion slot.....	1-23
1.2.6	Onboard buttons	1-25
1.2.7	Onboard LEDs	1-27
1.2.8	Internal connectors.....	1-35
1.2.9	Probelt.....	1-44
1.2.10	SupremeFX Impact II audio card	1-45

Chapter 2: Basic Installation

2.1	Building your PC system.....	2-1
2.1.1	Motherboard installation.....	2-1
2.1.2	CPU installation.....	2-4
2.1.3	SupremeFX Impact II audio card installation	2-5
2.1.4	DIMM installation.....	2-6
2.1.5	CPU heatsink and fan assembly installation	2-7
2.1.6	ATX Power connection.....	2-10
2.1.7	SATA device connection	2-11
2.1.8	Front I/O Connector	2-12
2.1.9	Expansion Card installation.....	2-13
2.1.10	Impact CoolHub Card installation.....	2-13
2.1.11	mPCIe Combo IV card installation	2-14

2.2	BIOS update utility	2-18
2.3	Motherboard rear and audio connections	2-19
	2.3.1 Rear I/O connection	2-19
	2.3.2 Audio I/O connections	2-21
2.4	Starting up for the first time	2-24
2.5	Turning off the computer	2-24

Chapter 3: BIOS setup

3.1	Knowing BIOS	3-1
3.2	BIOS setup program	3-2
	3.2.1 EZ Mode	3-3
	3.2.2 Advanced Mode	3-4
	3.2.3 QFan Control	3-7
	3.2.4 EZ Tuning Wizard	3-9
3.3	My Favorites	3-11
3.4	Extreme Tweaker menu	3-13
3.5	Main menu	3-34
3.6	Advanced menu	3-36
	3.6.1 CPU Configuration	3-37
	3.6.2 PCH Configuration	3-40
	3.6.3 PCH Storage Configuration	3-42
	3.6.4 System Agent Configuration	3-44
	3.6.5 USB Configuration	3-46
	3.6.6 Platform Misc Configuration	3-47
	3.6.7 Onboard Devices Configuration	3-49
	3.6.8 APM	3-51
	3.6.9 Network Stack Configuration	3-52
	3.6.10 ROG Effects	3-52
	3.6.11 Intel(R) Rapid Storage Technology	3-53
3.7	Monitor menu	3-54
3.8	Boot menu	3-57
3.9	Tools menu	3-63
	3.9.1 ASUS EZ Flash 2 Utility	3-63
	3.9.2 Secure Erase	3-63
	3.9.3 Graphics Card Information	3-64
	3.9.4 ASUS Overclocking Profile	3-65
	3.9.5 ASUS SPD Information	3-66
	3.9.6 ROG OC Panel H-Key Configure	3-66

3.10	Exit menu	3-68
3.11	Updating BIOS	3-69
3.11.1	EZ Update	3-69
3.11.2	ASUS EZ Flash 2	3-70
3.11.3	ASUS CrashFree BIOS 3	3-71

Chapter 4: Software support

4.1	Installing an operating system	4-1
4.2	Support DVD information	4-1
4.2.1	Running the support DVD	4-1
4.2.2	Obtaining the software manuals	4-2
4.3	Software information	4-3
4.4	AI Suite 3	4-3
4.4.1	Dual Intelligent Processors 5	4-7
4.4.2	USB 3.0 Boost	4-19
4.4.3	USB BIOS Flashback	4-20
4.4.4	USB Charger+	4-22
4.4.5	Wi-Fi Engine	4-23
4.4.6	EZ Update	4-25
4.4.7	Push Notice	4-27
4.4.8	System Information	4-30
4.5	Wi-Fi GO!	4-32
4.5.1	Signing in to your ASUS Account	4-33
4.5.2	Using Wi-Fi GO!	4-35
4.6	ASUS Media Streamer	4-44
4.6.1	System requirements	4-44
4.6.2	Using ASUS Media Streamer	4-45
4.7	ROG Audio features	4-46
4.7.1	Sonic Studio	4-46
4.7.2	Sonic SenseAmp	4-48
4.7.3	Sonic SoundStage	4-50
4.8	Sonic Radar II	4-52
4.9	GameFirst III	4-54
4.10	Keybot	4-57
4.11	MemTweakIt	4-59
4.12	RAMDisk	4-61
4.13	ROG CPU-Z	4-64

Chapter 5: RAID support

5.1	RAID configurations	5-1
5.1.1	RAID definitions	5-1
5.1.2	Installing Serial ATA hard disks	5-2
5.1.3	Setting the RAID item in BIOS	5-2
5.1.4	Intel® Rapid Storage Technology Option ROM utility	5-3
5.2	Creating a RAID driver disk	5-7
5.2.1	Creating a RAID driver disk without entering the OS	5-7
5.2.2	Creating a RAID driver disk in Windows®	5-8
5.2.3	Installing the RAID driver during Windows® OS installation	5-8

Appendices

Notices	A-1
ASUS contact information	A-5

Safety information

Electrical safety

- To prevent electrical shock hazard, disconnect the power cable from the electrical outlet before relocating the system.
- When adding or removing devices to or from the system, ensure that the power cables for the devices are unplugged before the signal cables are connected. If possible, disconnect all power cables from the existing system before you add a device.
- Before connecting or removing signal cables from the motherboard, ensure that all power cables are unplugged.
- Seek professional assistance before using an adapter or extension cord. These devices could interrupt the grounding circuit.
- Ensure that your power supply is set to the correct voltage in your area. If you are not sure about the voltage of the electrical outlet you are using, contact your local power company.
- If the power supply is broken, do not try to fix it by yourself. Contact a qualified service technician or your retailer.

Operation safety

- Before installing the motherboard and adding devices on it, carefully read all the manuals that came with the package.
- Before using the product, ensure all cables are correctly connected and the power cables are not damaged. If you detect any damage, contact your dealer immediately.
- To avoid short circuits, keep paper clips, screws, and staples away from connectors, slots, sockets and circuitry.
- Avoid dust, humidity, and temperature extremes. Do not place the product in any area where it may become wet.
- Place the product on a stable surface.
- If you encounter technical problems with the product, contact a qualified service technician or your retailer.

About this guide

This user guide contains the information you need when installing and configuring the motherboard.

How this guide is organized

This guide contains the following parts:

1. Chapter 1: Product introduction

This chapter describes the features of the motherboard and the new technology it supports. It includes description of the switches, jumpers, and connectors on the motherboard.

2. Chapter 2: Basic Installation

This chapter lists the hardware setup procedures that you have to perform when installing system components.

3. Chapter 3: BIOS setup

This chapter tells how to change system settings through the BIOS Setup menus. Detailed descriptions of the BIOS parameters are also provided.

4. Chapter 4: Software support

This chapter describes the contents of the support DVD that comes with the motherboard package and the software.

5. Chapter 5: RAID support

This chapter describes the RAID configurations.

Where to find more information

Refer to the following sources for additional information and for product and software updates.

1. ASUS website

The ASUS website (www.asus.com) provides updated information on ASUS hardware and software products.

2. Optional documentation

Your product package may include optional documentation, such as warranty flyers, that may have been added by your dealer. These documents are not part of the standard package.

Conventions used in this guide

To ensure that you perform certain tasks properly, take note of the following symbols used throughout this manual.



DANGER/WARNING: Information to prevent injury to yourself when trying to complete a task.



CAUTION: Information to prevent damage to the components when trying to complete a task



IMPORTANT: Instructions that you **MUST** follow to complete a task.



NOTE: Tips and additional information to help you complete a task.

Typography

Bold text

Indicates a menu or an item to select.

Italics

Used to emphasize a word or a phrase.

<Key>

Keys enclosed in the less-than and greater-than sign means that you must press the enclosed key.

Example: <Enter> means that you must press the Enter or Return key.

<Key1> + <Key2> + <Key3>

If you must press two or more keys simultaneously, the key names are linked with a plus sign (+).

MAXIMUS VII IMPACT specifications summary

CPU	<p>LGA1150 socket for 4th, New 4th, and 5th Generation Intel® Core™ i7/Intel® Core™ i5/Intel® Core™ i3, Pentium®, and Celeron® processors</p> <p>Supports 22nm CPU</p> <p>Supports Intel® Turbo Boost Technology 2.0*</p> <p>* The Intel® Turbo Boost Technology 2.0 support depends on the CPU types.</p> <p>** Refer to www.asus.com for Intel® CPU support list</p>
Chipset	<p>Intel® Z97 Express Chipset</p>
Memory	<p>Dual channel memory architecture</p> <p>2 x DIMM, max. 16GB, DDR3 3300 (O.C.)* / 3200 (O.C.)* / 3100 (O.C.)* / 3000 (O.C.)* / 2933 (O.C.)* / 2800 (O.C.)* / 2666 (O.C.)* / 2600 (O.C.)* / 2500 (O.C.)* / 2400 (O.C.)* / 2200 (O.C.)* / 2133 (O.C.)* / 2000 (O.C.)* / 1866 (O.C.)* / 1800 (O.C.)* / 1600 / 1333 MHz, non-ECC, un-buffered memory</p> <p>Supports Intel® Extreme Memory Profile (XMP)</p> <p>* Hyper DIMM support is subject to the physical characteristics of individual CPUs. Please refer to Memory QVL (Qualified Vendors List) for details.</p>
Expansion slots	<p>1 x PCI Express 3.0/2.0 x16 slot</p> <p>1 x mini-PCI Express 2.0 x1 slot* on mPCIe Combo IV expansion card</p> <p>* The mini PCIe slot is pre-installed with a Wi-Fi/Bluetooth module.</p>
VGA	<p>Integrated Intel® HD Graphics Processor</p> <p>DisplayPort 1.2 with max. resolution of 4096 x 2160 @ 24Hz and 3840 x 2160 @ 60Hz</p> <p>HDMI with max. resolution of 4096 x 2160 @ 24Hz / 2560 x 1600 @ 60Hz</p> <p>Supports Intel® InTru™ 3D, Intel® Quick Sync Video, Intel® Clear Video HD Technology, and Intel® Insider™</p>
Storage	<p>Intel® Z97 Express Chipset</p> <p>4 x SATA 6 Gb/s ports</p> <ul style="list-style-type: none"> - Intel® Rapid Storage Technology 13 supports RAID 0, 1, 5, and 10 - Intel® Smart Response Technology, Intel® Rapid Start Technology, and Intel® Smart Connect Technology* <p>1 x M.2 (NGFF) Socket 3 with M Key**</p> <ul style="list-style-type: none"> - Supports PCI Express 3.0 x4 standard - Supports M.2 (NGFF) Type 2242/2260/2280/22110 SSD card (up to 110mm in length) <p>* The supported functions depend on the CPU installed.</p> <p>** The M.2 slot shares bandwidth with PCIe 3.0 x16 slot. Bandwidth on the PCIe 2.0 x16 becomes x8 when an M.2 device is inserted.</p>

(continued on the next page)

MAXIMUS VII IMPACT specifications summary

LAN	<p>1 x Intel® I218-V Gigabit LAN - Dual interconnect between the integrated Media Access Controller (MAC) and physical layer (PHY) Anti-surge LANGuard ROG GameFirst III</p>
Wireless	<p>Wi-Fi 802.11 a/b/g/n/ac supports dual frequency band 2.4/5 Ghz Bluetooth v4.0/3.0+HS</p> <p>* The module is pre-installed on the mPCIe Combo IV expansion card.</p>
Audio	<p>ROG SupremeFX Impact II 8-Channel High Definition Audio CODEC*</p> <ul style="list-style-type: none"> - SupremeFX Shielding Technology - ELNA® Premium Audio Capacitors - Content Protection for Full Rate lossless DVD Audio, Blu-ray DVD, and HD-DVD audio content playback - Jack-detection, Multi-streaming, Front Panel Jack-retasking* - Optical S/PDIF out port at back panel <p>Audio Feature:</p> <ul style="list-style-type: none"> - Sonic SoundStage - Sonic SenseAmp - Sonic Studio - Sonic Radar II - DTS Connect <p>* Jack-retasking supports 8-channel audio output using a chassis with HD audio module in the front panel.</p>
USB	<p>Intel® Z97 Express Chipset</p> <p>6 x USB 3.0 ports (4 ports at back panel [blue], 2 ports at mid-board [red]*)</p> <p>6 x USB 2.0 ports (4 ports at back panel, 2 ports at mid-board**)</p> <p>* Support ASUS USB 3.0 Boost. UASP standard on the Intel® native USB 3.0 is only supported under Windows® 8/ Windows® 8.1.</p> <p>** 2 x USB 2.0 ports at mid-board (USB1213) share with ROG extension (ROG_EXT) port.</p>
Back I/O Ports	<p>1 x Optical S/PDIF out 1 x HDMI port 1 x DisplayPort 1 x Q-Code LED 1 x Sonic SoundStage button 1 x KeyBot button 1 x Clear CMOS button 1 x ROG Connect button 4 x USB 2.0 ports (1 port can be switched to ROG Connect) 4 x USB 3.0 ports [blue]</p>

(continued on the next page)

MAXIMUS VII IMPACT specifications summary

<p>Back I/O Ports</p>	<p>1 x PS/2 Keyboard/mouse combo port 1 x Anti-surge LAN (RJ-45) port 3 x Audio jacks*</p> <p>* Audio jacks are located on SupremeFX Impact II card.</p>
<p>ROG Exclusive Features</p>	<p>Impact CoolHub SupremeFX Impact II Impact Power II</p> <ul style="list-style-type: none"> - Full digital 8+2 phase CPU/DRAM power - NexFET™ Power Block MOSFET - 60A BlackWing Chokes - 10K Black Metallic Capacitors <p>mPCIe Combo IV (mPCIe/M.2 combo card) KeyBot</p> <ul style="list-style-type: none"> - CPU Level Up - X.M.P. - DirectKey <p>ROG Connect*</p> <ul style="list-style-type: none"> - RC Diagram - RC Remote - RC Poster <p>UEFI BIOS features</p> <ul style="list-style-type: none"> - Extreme Tweaker - Tweaker's Paradise - ROG SSD Secure Erase - GPU.DIMM Post - O.C. Profile - Graphics Card Information Preview <p>ROG RAMDisk Probelt</p> <p>* The dedicated ROG Connect cable is sold separately.</p>
<p>Special Features</p>	<p>ASUS Dual Intelligent Processors 5</p> <ul style="list-style-type: none"> - Perfectly consolidates TPU, EPU, DIGI+ Power Control, Fan Xpert 2, and Turbo App <p>ASUS Exclusive Features</p> <ul style="list-style-type: none"> - AI Suite 3 - USB 3.0 Boost - USB Charger+ - AI Charger - Push Notice - Disk Unlocker <p>ASUS EZ DIY</p> <ul style="list-style-type: none"> - USB BIOS Flashback - ASUS CrashFree BIOS 3 - ASUS EZ Flash 2 - ASUS C.P.R. (CPU Parameter Recall)

(continued on the next page)

MAXIMUS VII IMPACT specifications summary

Special Features	ASUS Q-Design <ul style="list-style-type: none"> - ASUS Q-Code - ASUS Q-Shield - ASUS Q-LED (CPU, DRAM, VGA, Boot Device LED) - ASUS Q-DIMM
Internal Connectors	<ul style="list-style-type: none"> 1 x USB 3.0 connector (supports additional 2 USB 3.0 ports) 1 x USB 2.0 connector (supports additional 2 USB 2.0 ports sharing with ROG_EXT header) 4 x SATA 6 Gb/s connectors 1 x ROG Extension (ROG_EXT) header 1 x 4-pin CPU fan connector 3 x 4-pin Chassis fan connectors (2 x 4-pin Chassis fan on Impact CoolHub card) 1 x 24-pin EATX power connector 1 x 8-pin EATX 12V Power connector 10 x Probelts measurement points 1 x LN2 Mode jumper on Impact CoolHub card 1 x Power-on button 1 x Reset button 1 x Front panel audio connector (AAFP)* 1 x TPM connector 1 x System panel connector 1 x SupremeFX Impact II connector 1 x mPCIe Combo IV connector 1 x Impact CoolHub connector <p>* AAFP connector is built-in on the SupremeFX Impact II card.</p>
BIOS Features	64 Mb Flash ROM, UEFI AMI BIOS, PnP, DMI 2.7, WfM 2.0, SM BIOS 2.8, ACPI5.0, Multi-language BIOS
Manageability	WfM2.0, DMI2.7, WOL by PME, PXE
Software	<ul style="list-style-type: none"> Drivers ROG GameFirst III ROG RAMDisk ROG CPU-Z ROG Mem Tweakt Kaspersky® Anti-Virus DAEMON Tools Pro Standard ASUS WebStorage ASUS HomeCloud ASUS Utilities
Operating system	Windows® 8.1 / Windows® 8 / Windows® 7
Form Factor	Mini-ITX form factor, 6.7" x 6.7" (17 cm x 17 cm)



Specifications are subject to change without notice.

Package contents

Check your motherboard package for the following items.

Motherboard	ROG MAXIMUS VII IMPACT
Cables	4 x SATA 6 Gb/s cables
Accessories	I/O Shield 1 x 12-in-1 ROG cable label 1 x Q-Cable 1 x Optional 4-in-1 washers for CPU cooler backplate 1 x SupremeFX Impact II audio card 1 x mPCIe Combo IV card with dual-band Wi-Fi a/b/g/n/ac + Bluetooth v4.0/3.0+HS module 1 x 2T2R dual-band Wi-Fi moving antennas 1 x Impact CoolHub card
Application DVD	ROG motherboard support DVD
Documentation	User guide



If any of the above items is damaged or missing, contact your retailer.

Installation tools and components

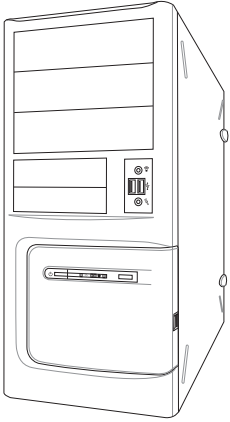

PC chassis

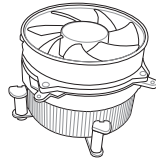

Intel® LGA1150 compatible CPU Fan

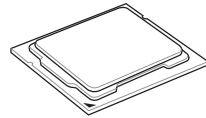

Intel® LGA1150 CPU

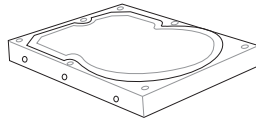

SATA hard disk drive



Philips (cross) screwdriver

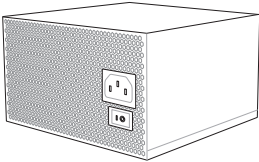

Power supply unit

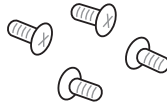

1 bag of screws

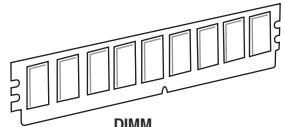

DIMM

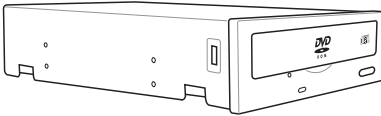

SATA optical disc drive (optional)

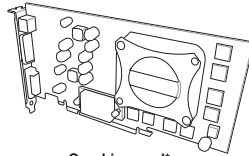

Graphics card*



The tools and components in the table above are not included in the motherboard package.

* Graphics card is optional.

Product introduction

1.1 Special features

1.1.1 Product highlights

Republic of Gamers

The Republic of Gamers offers you the best of the best. We offer the best hardware engineering, the fastest performance, the most innovative ideas, and we welcome the best gamers to join in. In the Republic of Gamers, mercy rules are only for the weak, and bragging rights means everything. We believe in making statements and we excel in competitions. If your character matches our trait, then join the elite Republic of Gamers and make your presence felt.

LGA1150 socket for 4th, New 4th, and 5th Generation Intel® Core™ i7 / Intel® Core™ i5 / Intel® Core™ i3, Pentium®, and Celeron® Processors

This motherboard supports 4th, New 4th, and 5th generation Intel® Core™ i7/ Intel® Core™ i5/ Intel® Core™ i3, Pentium® and Celeron® processors in the LGA1150 package. It provides great graphics and system performance with its GPU, dual-channel DDR3 memory slots, and PCI Express 2.0/3.0 expansion slots.

Intel® Z97 Express Chipset

Intel® Z97 Express Chipset is a single-chipset that supports the LGA1150 socket for 4th, New 4th, and 5th generation Intel® Core™ i7/ Intel® Core™ i5/ Intel® Core™ i3, Pentium® and Celeron® processors. It utilizes the serial point-to-point links, which increases bandwidth and enhances the system's performance. It natively supports up to six USB 3.0 ports for up to ten times faster transfer rate than USB 2.0 and six SATA 6 Gb/s ports.

PCI Express® 3.0

PCI Express® 3.0 (PCIe 3.0) is the PCI Express bus standard that provides twice the performance and speed of PCIe 2.0. It provides an optimal graphics performance, unprecedented data speed and seamless transition with its complete backward compatibility to PCIe 1.0/2.0 devices.

1.1.2 ROG Gaming Features

SupremeFX Impact II

The bundled SupremeFX Impact II sound card, a dedicated audio hardware for ROG motherboards, provides pristine effects and full-range soundtracks for a more real-feel game. Its cutting-edge isolation technology minimizes electromagnetic interference (EMI) and exceptionally premium components that deliver best audio. SupremeFX Impact II provides finer components and superb software innovation for the best gaming and multimedia experience.

Sonic Radar II

Sonic Radar, an audio app designed for First Person Shooting (FPS) games, shows the precise direction and intensity of where a sound is coming from. In-game sound including gunshots, footprints, voice call-outs, or even a ticking bomb, is visualized as radar signals on the Sonic Radar display, providing you the advantage to know potential threats and avoid sneaky surprises.

Sonic Studio

Sonic Studio is an audio tuning software that simulates 7.1 channels even through a stereo (2.0-channel) headset with its virtual surround-sound function. It comes with six superb audio controls including Reverb, Bass Boost, Equalizer, Voice Clarity, Smart EQ (Smart Volume), and Virtual Surround.

Sonic SoundStage

Sonic SoundStage is an on-board solution that improves audio experience when you connect your front-panel headset. It works with any operating system and on any game. You can choose from any of the four presets or manually fine tune your own setting to fire up your game.

Sonic SenseAmp

Sonic SenseAmp is an exclusive ROG invention that automatically detects your headset's impedance and adjusts the built-in amp accordingly. Sonic SenseAmp makes tuning your high-quality headphones as simple as plugging them in.

KeyBot

KeyBot is a built-in microprocessor that provides instant upgrade to your keyboard. You can configure and assign macros to specific keys on your keyboard to perform specific or several task at the same time. You can also configure your PC to wake up in CPU Level UP, XMP, or directly to BIOS mode.



This feature supports USB keyboards only.

GameFirst III

ASUS GameFirst III is a network management software that features four preset packet prioritized profiles (Optimization, Game, Media Streaming and File Sharing) facilitating user's need. Users can also manually allocate bandwidth and adjust priority settings of each application to run faster and smoother.

Intel® Ethernet

This LAN solution from Intel features high TCP and UDP throughput with lower CPU utilization for a smooth networking experience. It has advanced features including advanced interrupt-handling, low-power consumption, and Intel Stable Image Platform Program (SIPP) support thanks to its compatibility with the Intel CPU and chipset.

1.1.3 ROG Exclusive Features

M.2 Support

This motherboard features the M.2 slot, which shares bandwidth with PCIe 3.0 x4 slot to speed up data transfer rate. This helps enhance the performance of your Solid State Drive (SSD) that is dedicated only to the operating system. The M.2 slot provides support for faster access to data and applications, and quicker wake up time for your system.



- Supports PCIe interface only.
- Supports 2242/2260/2280/22110 SSD card up to 110 mm in length.

ROG Connect

ROG Connect allows you to monitor the status of your desktop PC and tweak its parameters in real time via a notebook. ROG Connect links your main system to a notebook through a USB cable, allowing you to view real-time POST code and hardware status readouts on your notebook, as well as make on-the-fly parameter adjustments at a purely hardware level.

Impact Power II

The Impact Power II's vertical architecture provides you the same vaunted overvolting and overclocking flexibilities just like any other ROG boards - without sacrificing stability, overclocking, and precision on mini-ITX form factor. For precise CPU/memory digital power control, Impact Power II utilizes the best components such as BlackWing chokes, special fin design, and super-premium 10K black metallic solid state capacitors.

BlackWing chokes can handle as much as 60A of power, which is twice that of generic chokes. The special fin design, with its highly conductive and efficient gold-treated coating, results in 3-5°C lower choke temperatures for added stability and ensures minimal-loss power delivery. Super-premium 10K Black Metallic solid state capacitors are forged for overclocking and the most extreme demands, lasting up to five times longer than generic capacitors with 20% wider temperature tolerance.

iROG

The iROG is a special IC that fully maximizes ROG's unique functions, providing you with full control of your motherboard at any stage. It increases your overclocking, and offers you with advanced system control and management features purely at a hardware level.

LANGuard

ROG revolutionizes the LAN port with its advanced signal-coupling technology and premium surface-mounted components that improve throughput, while surge-protected and electrostatic-guarded components (ESD Guards) protect your motherboard from lightning strikes and static electricity.

CPU Level Up

With ROG's CPU Level Up, overclocking has never been so easy, or cost-free. Simply select the processor that you want to overclock to, and the motherboard will do the rest.

GPU.DIMM Post

GPU.DIMM Post enables you to catch potential problems even before you enter the OS, saving you valuable time in detecting component failure under extreme conditions. With GPU.DIMM Post, you can easily and quickly check the status of your graphics cards, memory modules, and overclocking settings.

BIOS Print

ROG offers a whole UEFI BIOS feature to handle the demands of an overclocking experience. The motherboard features ROG BIOS Print that allows you to easily share your BIOS settings to others with a press of a button.

Probelt

Your motherboard consists of ten (10) Probelt measurement points that help you detect the amount of voltage currently running in your system. Use a multi-tester device to measure the voltage of your system and its components and peripherals.

Extreme Tweaker

Extreme Tweaker is the one stop shop to fine-tune your system to optimal performance. With Extreme Tweaker, you can adjust the system settings such as frequency, over-voltage, memory timing, and more.

Loadline Calibration

The Loadline Calibration ensures stable and optimal CPU voltage under heavy loading. It provides the ultimate overclocking capabilities and benchmark scores for your motherboard.

1.1.4 ASUS Special Features

AI Suite 3

With its user-friendly interface, ASUS AI Suite 3 consolidates all the exclusive ASUS features into one simple-to-use software package. It allows you to supervise fan speed control, voltage and sensor readings. This all-in-one software offers diverse and ease to use functions, with no need to switch back and forth between different utilities.

USB BIOS FlashBack

USB BIOS Flashback offers a hassle-free updating solution for your ultimate convenience. Install a USB storage device containing the BIOS file, press the BIOS Flashback button for about three seconds, and the UEFI BIOS is automatically updated even without entering the existing BIOS or operating system. It also allows you to regularly check for UEFI BIOS updates, and download the latest BIOS automatically.

USB 3.0 Boost

ASUS USB 3.0 Boost, which supports USB 3.0 standard UASP (USB Attached SCSI Protocol), significantly increases a USB device's transfer speed up to 170% faster than the already impressive USB 3.0 transfer speed. It automatically accelerates data speeds for compatible USB 3.0 peripherals without the need for any user interaction.

1.1.5 ROG rich bundled software

Kaspersky® Anti-Virus

Kaspersky® Anti-Virus Personal offers premium antivirus protection for individual users and home offices. It is based on advanced antivirus technologies. The product incorporates the Kaspersky® Anti-Virus engine, which is renowned for malicious program detection rates that are among the industry's highest.

DAEMON Tools Pro Standard

DAEMON Tools Pro offers essential functionality to backup CD, DVD and Blu-ray discs. It converts optical media into virtual discs and emulates devices to work with the virtual copies. DAEMON Tools Pro organizes data, music, video, and photo collections on a PC, notebook, or netbook.

ROG CPU-Z

ROG CPU-Z is a customized ROG version utility authorized by Intel's CPU Identification (CPUID) that allows you to gather information of the main devices of your system. It gives you the information and status of your CPU, motherboard, memory, and the whole component. Use the ROG look of reporting your system's current information with ROG CPU-Z.

MemTweakIt

MemTweakIt is a DRAM efficiency tool that allows you to read DRAM timings and allows you to post and share your DRAM configuration scores to the ROG website.

RAMDisk

RAMDisk reserves part of system memory and turns it into actual storage, allowing you to place favorite app and game cache files in it to enjoy high-speed RAM performance while accessing them. With the Dynamic Memory Allocation function, it also releases the unused memory of RAMDisk back to the system when needed. It also extends SSD lifespan, keeps your main storage optimized for really important tasks, and automatically backs up and restore data.

SSD Secure Erase

Your ROG motherboard comes with SSD Secure Erase that deletes all data from an SSD while recovering lost performance and restores factory speeds. The SSD Secure Erase embedded to the UEFI BIOS for better compatibility and easy use.

DTS Connect

To get the most out of your audio entertainment across all formats and quality levels, DTS Connect combines two enabling technologies, DTS Neo:PC™ upmixes stereo sources (CDs, MP3s, WMAs, internet radio) into as many as 7.1 channels of incredible surround sound. Consumers can connect their PC to a home theater system. DTS Interactive is capable of performing multi-channel encoding of DTS bitstreams on personal computers, and sending encoded bitstreams out of a digital audio connection (such as S/PDIF or HDMI) designed to deliver audio to an external decoder.

1.2 Motherboard overview

1.2.1 Before you proceed

Take note of the following precautions before you install motherboard components or change any motherboard settings.



-
- Unplug the power cord from the wall socket before touching any component.
 - Before handling components, use a grounded wrist strap or touch a safely grounded object or a metal object, such as the power supply case, to avoid damaging them due to static electricity.
 - Hold components by the edges to avoid touching the ICs on them.
 - Whenever you uninstall any component, place it on a grounded antistatic pad or in the bag that came with the component.
 - Before you install or remove any component, ensure that the ATX power supply is switched off or the power cord is detached from the power supply. Failure to do so may cause severe damage to the motherboard, peripherals, or components.
-

1.2.2 Motherboard layout

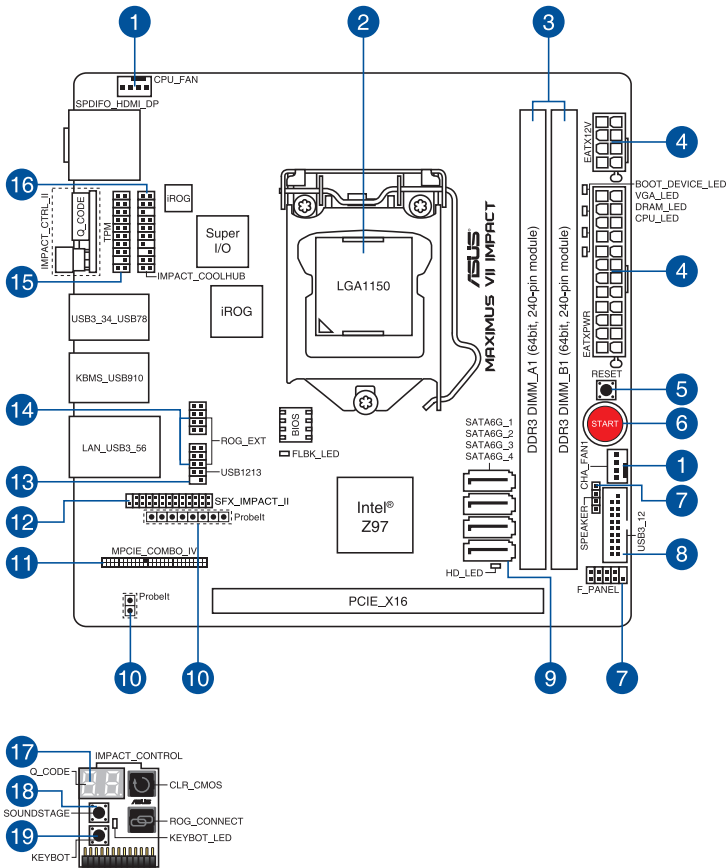

Refer to sections 1.2.8 Internal connectors and 2.3.1 Rear I/O connection for more information about rear panel connectors and internal connectors.

Layout contents

Connectors/Jumpers/Buttons/Slots	Page
1. CPU and chassis fan connectors (4-pin CPU_FAN; 4-pin CHA_FAN1)	1-38
2. LGA1150 CPU Socket	1-9
3. DDR3 DIMM slots	1-10
4. ATX Power connectors (24-pin EATXPWR, 8-pin EATX12V)	1-39
5. RESET button	1-25
6. START (Power-on) button	1-25
7. Front panel and speaker connectors (10-1 pin F_PANEL; 4 pin SPEAKER)	1-40
8. USB 3.0 connectors (20-1 pin USB3_12)	1-36
9. Intel® Z97 Serial ATA 6 Gb/s connectors (7-pin SATA6G_1-4 [red])	1-35
10. Probelts measurement points	1-44
11. mPCIe Combo IV connector (50-1 MPCIE_COMBO_IV)	1-42
12. SupremeFX Impact II connector (20-1 pin SFX_IMPACT_II)	1-42
13. USB 2.0 connectors (10-1 pin USB1213)	1-37
14. ROG Extension connector (8 pin ROG_EXT)	1-41
15. TPM connector (10-1 pin TPM)	1-41
16. Impact_CoolHub connector (20-1 pin IMPACT_COOLHUB)	1-43
17. Q_Code LEDs	1-29
18. SoundStage button	1-26
19. KeyBot button	1-26

1.2.3 Central Processing Unit (CPU)

The motherboard comes with a surface mount LGA1150 socket designed for the 4th, New 4th, and 5th Generation Intel® Core™ i7 / Intel® Core™ i5 / Intel® Core™ i3, Pentium®, and Celeron® processors.

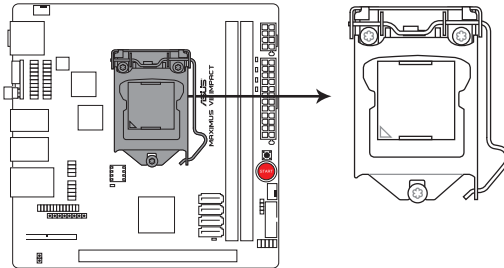

MAXIMUS VII IMPACT CPU LGA1150



- Ensure that all power cables are unplugged before installing the CPU.
- Ensure that you install the correct CPU designed for LGA1150 only. **DO NOT** install a CPU designed for LGA1155 and LGA1156 sockets on the LGA1150 socket.
- Upon purchase of the motherboard, ensure that the PnP cap is on the socket and the socket contacts are not bent. Contact your retailer immediately if the PnP cap is missing, or if you see any damage to the PnP cap/socket contacts/motherboard components. ASUS will shoulder the cost of repair only if the damage is shipment/transit-related.
- Keep the cap after installing the motherboard. ASUS will process Return Merchandise Authorization (RMA) requests only if the motherboard comes with the cap on the LGA1150 socket.
- The product warranty does not cover damage to the socket contacts resulting from incorrect CPU installation/removal, or misplacement/loss/incorrect removal of the PnP cap.

1.2.4 System memory

The motherboard comes with two Double Data Rate 3 (DDR3) Dual Inline Memory Modules (DIMM) slots.



A DDR3 module is notched differently from a DDR or DDR2 module. DO NOT install a DDR or DDR2 memory module to the DDR3 slot.

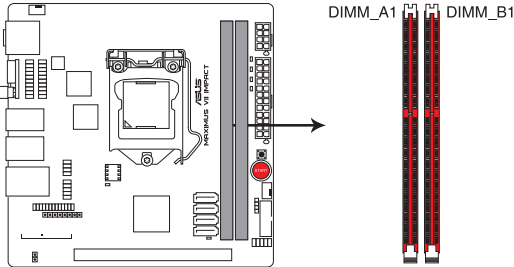

MAXIMUS VII IMPACT 240-pin DDR3 DIMM sockets

Recommended memory configurations

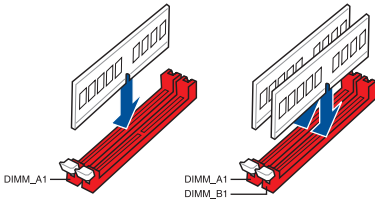

Memory configurations

You may install 1GB, 2GB, 4GB and 8GB unbuffered and non-ECC DDR3 DIMMs into the DIMM sockets.



- Memory module with memory frequency higher than 2133 MHz and its corresponding timing or the loaded XMP profile is not the JEDEC memory standard. The stability and compatibility of these memory modules depend on the CPU's capabilities and other installed devices.
- You may install varying memory sizes in Channel A and Channel B. The system maps the total size of the lower-sized channel for the dual-channel configuration. Any excess memory from the higher-sized channel is then mapped for single-channel operation.
- According to Intel CPU spec, DIMM voltage below 1.65V is recommended to protect the CPU.
- Always install DIMMs with the same CAS latency. For optimal compatibility, we recommend that you install memory modules of the same version or date code (D/C) from the same vendor. Check with the retailer to get the correct memory modules.
- Due to the memory address limitation on 32-bit Windows OS, when you install 4GB or more memory on the motherboard, the actual usable memory for the OS can be about 3GB or less. For effective use of memory, we recommend that you do any of the following:
 - a) Use a maximum of 3GB system memory if you are using a 32-bit Windows OS.
 - b) Install a 64-bit Windows OS when you want to install 4GB or more on the motherboard.
 - c) For more details, refer to the Microsoft® support site at <http://support.microsoft.com/kb/929605/en-us>.
- This motherboard does not support DIMMs made up of 512Mb (64MB) chips or less (Memory chip capacity counts in Megabit, 8 Megabit/Mb = 1 Megabyte/MB).



- The default memory operation frequency is dependent on its Serial Presence Detect (SPD), which is the standard way of accessing information from a memory module. Under the default state, some memory modules for overclocking may operate at a lower frequency than the vendor-marked value. To operate at the vendor-marked or at a higher frequency, refer to section **3.4 Extreme Tweaker menu** for manual memory frequency adjustment.
- For system stability, use a more efficient memory cooling system to support a full memory load (2 DIMMs) or overclocking condition.
- Memory modules with memory frequency higher than 2133MHz and their corresponding timing or the loaded XMP profile is not the JEDEC memory standard. The stability and compatibility of the memory modules depend on the CPU's capabilities and other installed devices.
- Always install the DIMMS with the same CAS Latency. For an optimum compatibility, we recommend that you install memory modules of the same version or data code (D/C) from the same vendor. Check with the vendor to get the correct memory modules.

MAXIMUS VI IMPACT Motherboard Qualified Vendors List (QVL)

DDR3 3300 MHz capability

Vendors	Part No.	Size	SS/DS	Chip Brand	Chip NO.	Timing	Voltage	DIMM socket support (Optional)
								2
G.SKILL	FE-3300C13D-8GTXDG (XMP)	8GB (2x4GB)	SS	-	-	13-15-15-35	1.65	

DDR3 3200 MHz capability

Vendors	Part No.	Size	SS/DS	Chip Brand	Chip NO.	Timing	Voltage	DIMM socket support (Optional)
								2
AVEXIR	*AVD3UH32001304G-4Ci(XMP)*	16GB (4x 4GB)	SS	-	-	13-15-15-35	1.65	•
G.SKILL	*F3-3200C12Q-16GTXDG(XMP)*	16GB (4x 4GB)	SS	-	-	12-15-15-35	1.65	•

DDR3 3100 MHz capability

Vendors	Part No.	Size	SS/DS	Chip Brand	Chip NO.	Timing	Voltage	DIMM socket support (Optional)
								2
AVEXIR	*AVD3UH31001204G-4Ci(XMP)*	16GB (4x 4GB)	SS	-	-	12-14-14-35	1.65	•
A-DATA	*AX3U3100W4G12-DMV(XMP)*	8GB (2x 4GB)	SS	-	-	12-14-14-36	1.65	•

DDR3 3000 MHz capability

Vendors	Part No.	Size	SS/DS	Chip Brand	Chip NO.	Timing	Voltage	DIMM socket support (Optional)
								2
AVEXIR	*AVD3UH30001204G-4BZ1(XMP)*	16GB (4x 4GB)	SS	-	-	12-14-14-35	1.65	•
G.SKILL	*G.SKILL F3-3000C12Q-16GTXDG(XMP)*	16GB (4x 4GB)	SS	-	-	12-14-14-35	1.65	•
G.SKILL	*F3-3000C12D-8GTXDG(XMP)*	8GB (2 x 4B)	SS	-	-	12-14-14-35	1.65	•
CORSAIR	*CMY8GX3M2A-3000C12R(XMP)*	8GB (2 x 4B)	SS	-	-	12-14-14-36	1.65	•

DDR3 2933 MHz capability

Vendors	Part No.	Size	SS/ DS	Chip Brand	Chip NO.	Timing	Voltage	DIMM socket support (Optional)
								2
G.SKILL	F3-2933C12D-8GTXDG(XMP)	8GB (2x4GB)	SS	-	-	12-14-14-35	1.65	•
G.SKILL	F3-2933C12Q-16GTXDG(XMP)	16GB (4x4GB)	SS	-	-	12-14-14-35	1.65	•
G.SKILL	F3-2933C12D-16GTXDG(XMP)	16GB (2x8GB)	DS	-	-	12-14-14-35	1.65	•
G.SKILL	F3-2933C12Q-32GTXDG(XMP)	32GB (4x8GB)	DS	-	-	12-14-14-35	1.65	•
CORSAIR	CMY16GX3M4A2933C12R(XMP)	16GB (4x4GB)	SS	-	-	12-14-14-36	1.65	•

DDR3 2800 MHz capability

Vendors	Part No.	Size	SS/ DS	Chip Brand	Chip NO.	Timing	Voltage	DIMM socket support (Optional)
								2
AVEXIR	AVD3UH28001208G-4BZ1(XMP)	32GB (4x8GB)	DS	-	-	12-14-14-35	1.65	•
A_DATA	AX3U2800W4G12(XMP)	16GB (4x4GB)	SS	-	-	12-14-14-36	1.65	•
A_DATA	AX3U2800W8G12(XMP)	32GB (4x8GB)	DS	-	-	12-14-14-36	1.65	•
G.SKILL	F3-2800C12Q-32GTXDG(XMP)	32GB (4x8GB)	DS	-	-	12-13-13-35	1.65	•
G.SKILL	F3-2800C12Q-32GTXDG(XMP)	32GB (4x8GB)	DS	-	-	12-14-14-35	1.65	•
G.SKILL	F3-2800C11Q-16GTXD(XMP)	16GB (4x4GB)	DS	-	-	11-13-13-35	1.65	•
G.SKILL	F3-2800C11D-8GTXD(XMP)	8GB (2x4GB)	DS	-	-	11-13-13-35	1.65	•
G.SKILL	F3-2800C11D-8GTXDG(XMP)	8GB (2x4GB)	DS	-	-	11-14-14-35	1.65	•
G.SKILL	F3-2800C11Q-16GTXDG(XMP)	16GB (4x4GB)	DS	-	-	11-14-14-35	1.65	•
G.SKILL	F3-2800C10D-8GTXD(XMP)	8GB (2x4GB)	DS	-	-	10-12-12-35	1.65	•
G.SKILL	F3-2800C12Q-16GTXDG(XMP)	16GB (4x4GB)	DS	-	-	12-14-14-35	1.65	•
G.SKILL	F3-2800C11D-16GTXDG(XMP)	16GB (2x8GB)	DS	-	-	11-14-14-35	1.65	•
G.SKILL	F3-2800C11Q-32GTXDG(XMP)	32GB (4x8GB)	DS	-	-	11-14-14-35	1.65	•
G.SKILL	F3-2800C11D-16GTXD(XMP)	16GB (2x 8GB)	DS	-	-	11-13-13-35	1.65	•
G.SKILL	F3-2800C11Q-32GTXD(XMP)	32GB (4x8GB)	DS	-	-	11-13-13-35	1.65	•
G.SKILL	F3-2800C12D-16GTXD(XMP)	16GB (2x8GB)	DS	-	-	12-14-14-35	1.65	•
APACER	78.BAGH5.AFD0C(XMP)	8GB (2x4GB)	DS	-	-	12-14-14-35	1.65	•
CORSAIR	CMD16GX3M4A2800C11(XMP)	16GB (4x4GB)	DS	-	-	11-14-14-35	1.65	•
CORSAIR	CMD16GX3M4A2800C12(XMP)	16GB (4x4GB)	DS	-	-	12-14-14-36	1.65	•
CORSAIR	CMY16GX3M4A2800C12R(XMP)	16GB (4x4GB)	SS	-	-	12-14-14-36	1.65	•
KINGSTON	KHX28C12T2K2/8X	8GB (2x4GB)	SS	-	-	12-14-14-32	1.65	•

DDR3 2666 MHz capacity

Vendors	Part No.	Size	SS/DS	Chip Brand	Chip NO.	Timing	Voltage	DIMM socket support (Optional)
								2
Apacer	78.BAGFF.AFC0C(XMP)	8GB (2x4GB)	DS	-	-	12-13-13-35	-	•
Apacer	78.BAGFR.AFD0C(XMP)	8GB (2x4GB)	DS	-	-	12-13-13-35	-	•
Apacer	78.CAGFF.AFD0C(XMP)	16GB (2x8GB)	DS	-	-	12-13-13-35	-	•
CORSAIR	CMD16GX3M4A2666C11 (Ver5.12)(XMP)	16GB (4x4GB)	DS	-	-	11-13-13-35	1.65	•
G.SKILL	F3-2666CL10Q-16GBZHD(XMP)	16GB (4x4GB)	DS	-	-	10-12-12-31	1.65	•
Gell	GOC32GB2666C11QC(XMP)	32GB (4x8GB)	DS	-	-	11-13-13-32	1.65	•
Kingston	KHX26C11T2K2/8X(XMP)	8GB (2x4GB)	SS	-	-	2666-11-13-13-32	1.65	•

DDR3 2400 MHz capacity

Vendors	Part No.	Size	SS/DS	Chip Brand	Chip NO.	Timing	Voltage	DIMM socket support (Optional)
								2
ADATA	AX3U2400W4G11-DMV(XMP)	8GB (2x4GB)	SS	-	-	11-13-13-35	1.65	•
ADATA	AX3U2400W8G11-DMV(XMP)	16GB (2x8GB)	DS	-	-	11-13-13-35	1.65	•
Apacer	78.BAGFL.AFD0C(XMP)	8GB (2x4GB)	DS	-	-	11-12-12-30	-	•
Apacer	783BAGF3.AFD0C(XMP)	8GB (2x4GB)	DS	-	-	11-11-11-30	-	•
CORSAIR	CMD16GX3M2A2400C10 (Ver4.21)(XMP)	16GB (2x8GB)	DS	-	-	10-12-12-31	1.65	•
CORSAIR	CMD32GX3M4A2400C10 (Ver5.29)(XMP)	32GB (4x8GB)	DS	-	-	10-12-12-31	1.65	•
CORSAIR	CMD32GX3M4A2400C10 (Ver4.21)(XMP)	32GB (4x8GB)	DS	-	-	10-12-12-31	1.65	•
CORSAIR	CMY16GX3M2A2400C10A (Ver4.21)(XMP)	16GB (8x2GB)	DS	-	-	10-12-12-31	1.65	•
CORSAIR	CMY16GX3M2A2400C10R (Ver4.21)(XMP)	16GB (2x8GB)	DS	-	-	10-12-12-31	1.65	•
CORSAIR	CMZ16GX3M2A2400C10 (Ver4.21)	16GB (2x8GB)	DS	-	-	10-12-12-31	1.65	•
G.SKILL	F3-19200CL10Q2-64GBZHD(XMP)	64GB (8x8GB)	DS	-	-	10-12-12-31	1.65	•
G.SKILL	F3-19200CL11Q-32GBZHD(XMP)	32GB (4x8GB)	DS	-	-	10-12-12-31	1.65	•
G.SKILL	F3-19200CL11Q-16GBZHD(XMP)	16GB (4x4GB)	DS	-	-	11-11-11-31	1.65	•
G.SKILL	F3-19200CL9D-4GBPIS(XMP)	4G (2x2GB)	DS	-	-	9-11-9-28	1.65	•
G.SKILL	F3-19200CL9Q-16GBZMD(XMP)	16GB (4x4GB)	DS	-	-	9-11-11-31	1.65	•
G.SKILL	F3-2400C11Q-32GX(M)(XMP)	32GB (4x8GB)	DS	-	-	11-13-13-31	1.65	•
Gell	GOC316GB2400C10QC(XMP)	16GB (4x4GB)	DS	-	-	10-11-11-30	1.65	•
Gell	GOC316GB2400C11QC(XMP)	16GB (4x4GB)	DS	-	-	11-11-11-30	1.65	•
Kingston	KHX2400C11D3K4/8GX(XMP)	8GB (4x2GB)	SS	-	-	11-13-11-30	1.65	•

(Continued on the next page)

DDR3 2400 MHz capacity

Vendors	Part No.	Size	SS/DS	Chip Brand	Chip NO.	Timing	Voltage	DIMM socket support (Optional)
								2
Kingston	KHX24C11K4/16X(XMP)	16GB (4x4GB)	DS	-	-	11-13-13-30	1.65	•
Kingston	KHX24C11T2K2/8X(XMP)	8GB (2x4GB)	DS	-	-	-	1.65	•
Kingston	KHX24C11T3K4(XMP)	16GB (4x4GB)	DS	-	-	2400-11-13-13-30	1.65	•
Kingston	KHX24C11T3K4/32X(XMP)	32GB (4x8GB)	DS	-	-	9-9-9-24	1.65	•
mushkin	997122R(XMP)	16GB (2x8GB)	DS	-	-	2400-10-12-12-28	1.65	•
Silicon Power	SP004GXLYU240NSA(XMP)	4GB	SS	-	-	2400-11-13-13-32	-	•
Team	TLD38G2400HC11CBK(XMP)	8GB	DS	-	-	11-13-13-35	1.65	•
Transcend	TX2400KLN-8GK(XMP)	8GB (2x4GB)	DS	-	-	2400-11-12-11-29	1.6	•

DDR3 2133 MHz capacity

Vendors	Part No.	Size	SS/DS	Chip Brand	Chip NO.	Timing	Voltage	DIMM socket support (Optional)
								2
ADATA	AX3U2133W4G10-DR(XMP)	8GB (2x4GB)	SS	-	-	10-11-11-30	1.65	•
ADATA	AX3U2133W8G10-DR(XMP)	16GB (2x8GB)	DS	-	-	10-11-11-30	1.65	•
Apacer	78.BAGE4.AFD0C(XMP)	8GB (2x4GB)	DS	-	-	9-9-9-24	-	•
Apacer	AHU04GFB33CAQ3R(XMP)	4GB	DS	-	-	11-13-13-31	-	•
CORSAIR	CMD16GX3M2A2133C9 (Ver4.21)(XMP)	16GB (2x8GB)	DS	-	-	9-11-11-31	1.65	•
CORSAIR	CMD32GX3M4A2133C9 (Ver4.21)(XMP)	32GB (4x8GB)	DS	-	-	9-11-11-31	1.65	•
CORSAIR	CMD8GX3M2A2133C9 (Ver1.5)(XMP)	8GB (2x4GB)	DS	-	-	9-11-10-27	1.5	•
CORSAIR	CMD8GX3M2B2133C9 (Ver5.12)(XMP)	8GB (2x4GB)	DS	-	-	9-11-11-31	1.65	•
CORSAIR	CMY8GX3M2A2133C11R (Ver4.21)(XMP)	8GB (2x4GB)	DS	-	-	11-11-11-27	1.5	•
CORSAIR	CM28GX3M2A2133C11R (Ver4.21)(XMP)	8GB (2x4GB)	DS	-	-	11-11-11-27	1.5	•
G.SKILL	F3-17000CL11Q2-64GBZLD(XMP)	64GB (8x8GB)	DS	-	-	11-11-11-30	1.5	•
G.SKILL	F3-17000CL9Q-16GBZHZ(XMP)	16GB (4x4GB)	DS	-	-	9-11-10-28	1.65	•
G.SKILL	F3-2133C10Q-32GSR(XMP)	32GB (4x8GB)	DS	-	-	10-12-12-31	1.5	•
G.SKILL	F3-2133C11Q-32GZL(XMP)	32GB (4x8GB)	DS	-	-	11-11-11-31	1.5	•
Kingston	KHX2133C11D3K4/16GX(XMP)	16GB (4x4GB)	DS	-	-	11-12-11-30	1.65	•
Kingston	KHX21C11T3FK8/64X(XMP)	64GB (8x8GB)	DS	-	-	9-9-9-24	1.5	•
Silicon Power	SP004GXLYU213NSA(XMP)	4GB	SS	-	-	2133-11-12-11-30	-	•
Silicon Power	SP008GXLYU213NSA(XMP)	8GB	DS	-	-	2133-11-12-11-30	-	•
Team	TLD38G2133HC11ABK(XMP)	8GB	DS	-	-	11-11-11-31	1.65	•
Transcend	TX2133KLN-16GK(XMP)	16GB (2x8GB)	DS	-	-	2133-10-11-10-27	1.6	•
Transcend	TX2133KLN-8GK(XMP)	8GB (2x4GB)	DS	-	-	2133-10-11-10-27	1.6	•

DDR3 2000 MHz capacity

Vendors	Part No.	Size	SS/ DS	Chip Brand	Chip NO.	Timing	Voltage	DIMM socket support (Optional)
AEXEA	AXA3ES4GK2000L28V(XMP)	4GB (2x2GB)	DS	-	-	-	1.65	•
ASint	SLA302G08-ML2HB(XMP)	4GB	DS	Hynix	H5TQ2G83BFRH9C	9-9-9-27	-	•
Gell	GUP34GB2000C9DC(XMP)	4GB (2x2GB)	DS	-	-	9-9-9-28	1.65	•

DDR3 1866 MHz capacity

Vendors	Part No.	Size	SS/ DS	Chip Brand	Chip NO.	Timing	Voltage	DIMM socket support (Optional)
CORSAIR	CMD16GX3M2A1866C9 (Ver5.29)(XMP)	16GB (2x8GB)	DS	-	-	1866 9-9-9-27	1.5	•
CORSAIR	CMD16GX3M4A1866C9 (Ver4.13)(XMP)	16GB (4x4GB)	DS	-	-	9-10-9-27	1.5	•
CORSAIR	CMD16GX3M4A1866C9 (Ver8.16)(XMP)	16GB (4x4GB)	DS	-	-	9-10-9-27	1.5	•
CORSAIR	CMD32GX3M4A1866C9 (Ver3.24)(XMP)	32GB (4x8GB)	DS	-	-	9-10-9-27	1.5	•
CORSAIR	CMD8GX3M2A1866C9 (Ver4.13)(XMP)	8GB (2x4GB)	DS	-	-	-	1.5	•
CORSAIR	CMD8GX3M2A1866C9 (Ver5.12)(XMP)	8GB (2x4GB)	DS	-	-	9-10-9-27	1.5	•
CORSAIR	CMD8GX3M2A1866C9 (Ver8.16)(XMP)	8GB (2x4GB)	DS	-	-	9-10-9-27	1.5	•
CORSAIR	CMT32GX3M4X1866C9 (Ver3.23)(XMP)	32GB (4x8GB)	DS	-	-	9-10-9-27	1.5	•
CORSAIR	CMY16GX3M2A1866C9 (Ver 4.21)(XMP)	16GB (2x8GB)	DS	-	-	9-10-9-27	1.5	•
CORSAIR	CMY8GX3M2A1866C9 (Ver3.24)(XMP)	8GB (2x4GB)	DS	-	-	9-10-9-27	1.5	•
CORSAIR	CMZ16GX3M2A1866C10 (Ver5.29)(XMP)	16GB (2x8GB)	DS	-	-	10-11-10-30	1.5	•
CORSAIR	CMZ16GX3M2A1866C9(XMP)	16GB (2x8GB)	DS	-	-	1866-9-10-9-27	1.5	•
CORSAIR	CMZ32GX3M4X1866C10 (Ver3.23)(XMP)	32GB (4x8GB)	DS	-	-	10-11-10-27	1.5	•
CORSAIR	CMZ32GX3M4X1866C10(Ver3.23)(XMP)	32GB (4x8GB)	DS	-	-	10-11-10-27	1.5	•
CORSAIR	CMZ8GX3M2A1866C9 (Ver8.16)(XMP)	8GB (2x4GB)	DS	-	-	9-10-9-27	1.5	•
CORSAIR	CMZ8GX3M2A1866C9(XMP)	8GB (2x4GB)	DS	-	-	9-10-9-27	1.5	•
CORSAIR	CMZ8GX3M2A1866C9G (Ver5.12)(XMP)	8GB (2x4GB)	DS	-	-	1866 9-10-9-27	1.5	•
crucial	BLE4G3D1869DE1TX0.16FKR(XMP)	4GB	DS	-	-	9-9-9-27	1.5	•
crucial	BLE4G3D1869DE1XT0.16FMD(XMP)	4GB	DS	-	-	9-9-9-27	1.5	•
crucial	BLE8G3D1869DE1TX0.16FED(XMP)	16GB (2x8GB)	DS	-	-	1866-9-9-9-27	1.5	•
crucial	BLS8G3D18ADS3.16FED	8GB	DS	-	-	10-10-10-30	1.5	•
crucial	BLT8G3D1869DT1TX0.16FED(XMP)	8GB	DS	-	-	9-9-9-27	1.5	•

(Continued on the next page)

DDR3 1866 MHz capacity

Vendors	Part No.	Size	SS/ DS	Chip Brand	Chip NO.	Timing	Voltage	DIMM socket support (Optional)
G.SKILL	F3-14900CL10Q-32GBZL(XMP)	32GB (4x8GB)	DS	-	-	10-11-10-30	1.5	•
G.SKILL	F3-14900CL9D-8GBSR(XMP)	8GB (2x4GB)	DS	-	-	9-10-9-28	1.5	•
G.SKILL	F3-14900CL9Q-16GBXL(XMP)	16GB (4x4GB)	DS	-	-	9-10-9-28	1.5	•
G.SKILL	F3-14900CL9Q-16GBZL(XMP)	16GB (4x4GB)	DS	-	-	9-10-9-28	1.5	•
G.SKILL	F3-14900CL9Q-16GBZL(XMP)	16GB (4x4GB)	DS	-	-	9-10-9-28	1.5	•
G.SKILL	F3-1866C10Q2-64GZM(XMP)	64GB (2x8GB)	DS	-	-	10-11-10-30	1.5	•
G.SKILL	F3-1866C10Q2-64GZM(XMP)	64GB (2x8GB)	DS	-	-	10-11-10-30	1.5	•
G.SKILL	F3-1866C9Q-32GX(XMP)	32GB (4x8GB)	DS	-	-	9-10-9-28	1.5	•
GeIL	GEEL316GB1866C9DC(XMP)	16GB (2x8GB)	DS	-	-	1866-9-10-9-28	1.65	•
Kingston	HX318C10FWK2/16	16GB (2x8GB)	DS	-	-	10-11-10-30	1.5	•
Kingston	KHX1866C9D3K2/8GX(XMP)	8GB (2x4GB)	DS	-	-	-	1.65	•
Silicon Power	SP004GLYU186NSA(XMP)	4GB	SS	-	-	1866-9-11-9-27	-	•
Silicon Power	SP008GLYU186NSA(XMP)	8GB	DS	-	-	1866-9-11-9-27	-	•
Team	TED38GM1866C13BK	8GB	DS	Hynix	H5TQ4 G83AFR	13-13-13-32	1.5	•
V-color	TD4G16C13-RD	4GB	DS	-	-	1866-13-13-13-32	1.5	•

DDR3 1600 MHz capacity

Vendors	Part No.	Size	SS/ DS	Chip Brand	Chip NO.	Timing	Voltage	DIMM socket support (Optional)
ADATA	AD3U1600W4G11	4GB	SS	A-DATA	3WCD-1211A	11-11-11-28	-	•
ADATA	AD3U1600W8G11	8GB	DS	A-DATA	3WCD-1211A	11-11-11-28	-	•
ADATA	ADDU1600W4G11-B	4GB	SS	A-DATA	DWND-1211A	9-9-9-24	-	•
ADATA	ADDU1600W8G11-B	8GB	DS	ELPIDA	J4208EBBG-GN-F	9-9-9-24	-	•
ADATA	AX3U1600W4G9-DB (XMP)	8GB (2x4GB)	SS	-	-	9-9-9-24	1.5	•
ADATA	AX3U1600W8G9-DB (XMP)	16GB (2x8GB)	DS	-	-	9-9-9-24	1.5	•
AMD	AE32G1609U1-U	2GB	SS	AMD	23EY4587MB6H	-	1.5	•
AMD	AE34G1609U2-U	4GB	DS	AMD	23EY4587MB6H	-	1.5	•
AMD	AP38G1608U2K(XMP)	8GB (2x4GB)	DS	-	-	9-9-9-28	1.65	•
Apacer	78.B1GE3.9L10C	4GB	DS	Apacer	AM5D5908DEQSK	-	1.65	•
Apacer	78.B1GET.9K00C	4GB	SS	Apacer	AM5D6008BQQSK	11-11-11-28	-	•
Apacer	78.C1GET.9K10C	8GB	DS	Apacer	AM5D6008BQQSK	11-11-11-31	-	•
Apacer	AHU04GFA60C9Q3R (XMP)	4GB	DS	-	-	11-11-11-28	-	•
Apacer	AHU08GFA60CBT3R (XMP)	8GB	DS	-	-	9-9-9-24	-	•

(Continued on the next page)

DDR3 1600 MHz capacity

Vendors	Part No.	Size	SS/DS	Chip Brand	Chip NO.	Timing	Voltage	DIMM socket support (Optional)
ASint	SLA302G08-EGG1C(XMP)	4GB	DS	Asint	302G08-GG1C	9-9-9-27	-	•
ASint	SLA302G08-EGJ1C(XMP)	4GB	DS	ASint	302G08-GJ1C	9-9-9-27	-	•
ASint	SLA302G08-EGN1C	4GB	DS	ASint	302G08-GN1C	-	-	•
ASint	SLA304G08-EGN6A	4GB	SS	ASint	304G08-GN6A	1600-11-11-11-28	1.5	•
ASint	SLA304G08-EGN6B	4GB	SS	ASint	304G08-GN6B	1600-11-11-11-28	1.5	•
ASint	SLA304G08-ENG1B	4GB	SS	ASint	304G08-GN1B	9-11-11-28	-	•
ASint	SLB304G08-EGJ1B(XMP)	8GB	DS	-	-	9-9-9-27	-	•
ASint	SLB304G08-EGN1B	8GB	DS	ASint	304G08-GN1B	-	-	•
ASint	SLZ302G08-EGN1C	2GB	SS	ASint	302G08-GN1C	-	-	•
AVEXIR	AVD3U16000904G-2CW(XMP)	8GB (2x4GB)	DS	-	-	11-11-11-28	1.5	•
CORSAIR	CMD16GX3M2A1600C9 (Ver.8.21)(XMP)	16GB (2x8GB)	DS	-	-	9-9-9-24	1.5	•
CORSAIR	CMD8GX3M2A1600C8 (Ver.5.12)(XMP)	8GB (2x4GB)	DS	-	-	1600 8-8-8-24	1.5	•
CORSAIR	CMD8GX3M2A1600C9 (Ver.2.12)(XMP)	8GB (2x4GB)	DS	-	-	9-9-9-24	1.5	•
CORSAIR	CML16GX3M2A1600C10 (Ver.2.21)(XMP)	16GB (2x8GB)	DS	-	-	10-10-10-27	1.5	•
CORSAIR	CML8GX3M2A1600C9 (Ver7.12)(XMP)	8GB (2x4GB)	DS	-	-	9-9-9-24	1.5	•
CORSAIR	CMV8GX3M1A1600C11	8GB	DS	-	-	11-11-11-30	-	•
CORSAIR	CMX8GX3M2A1600C9 (Ver.3.19)(XMP)	8GB (2x4GB)	SS	-	-	9-9-9-24	1.65	•
CORSAIR	CMZ16GX3M2A1600C10 (Ver.3.24)(XMP)	16GB (2x8GB)	DS	-	-	10-10-10-27	1.5	•
CORSAIR	CMZ16GX3M4A1600C9(XMP)	16GB (4x4GB)	DS	-	-	9-9-9-24	1.5	•
CORSAIR	CMZ16GX3M4X1600C9 (Ver.8.16)(XMP)	16GB (4x4GB)	DS	-	-	1600-9-9-9-24	1.5	•
CORSAIR	CMZ32GX3M4X1600C10 (Ver.2.2)(XMP)	32GB (4x8GB)	DS	-	-	10-10-10-27	1.5	•
CORSAIR	CMZ4GX3M1A1600C9 (Ver.8.16)(XMP)	4GB (1x4GB)	DS	-	-	9-9-9-24	1.5	•
CORSAIR	CMZ8GX3M1A1600C10 (Ver.3.23)(XMP)	8GB (1x8GB)	DS	-	-	10-10-10-27	1.5	•
CORSAIR	CMZ8GX3M1A1600C10 (Ver.8.21)(XMP)	8GB (1x8GB)	DS	-	-	10-10-10-27	1.5	•
CORSAIR	CMZ8GX3M2A1600C8(XMP)	8GB (2x4GB)	DS	-	-	8-8-8-24	1.5	•
crucial	BL54G3D1609DS1S00.16FMR(XMP)	4GB	DS	-	-	1600-9-9-9-24	1.5	•
crucial	BLT4G3D1608DT1TX0.16FM(XMP)	4GB	DS	-	-	8-8-8-24	1.5	•
crucial	CT102464BA160B.C16FED	8GB	DS	crucial	CT512X8-160B	11-11-11-28	-	•
elixir	M2X2G64CB88G7N -DG(XMP)	2GB	SS	Elixir	N2CB2G80GN-DG	9-9-9-28	-	•
elixir	M2X4G64CB8HG5 N-DG(XMP)	4GB	DS	Elixir	N2CB2G80GN-DG	9-9-9-28	-	•

(Continued on the next page)

DDR3 1600 MHz capacity

Vendors	Part No.	Size	SS/ DS	Chip Brand	Chip NO.	Timing	Voltage	DIMM socket support (Optional) 2
G.SKILL	F3-12800CL9D-8G BSR2(XMP)	8GB (2x4GB)	DS	-	-	9-9-9-24	1.25	•
G.SKILL	F3-12800CL9Q-16 GBXL(XMP)	16GB (4x4GB)	DS	-	-	9-9-9-24	1.5	•
G.SKILL	F3-12800CL9Q-16G BZL(XMP)	16GB (4x4GB)	DS	-	-	9-9-9-24	1.5	•
G.SKILL	F3-1600C9Q-32G XM(XMP)	32GB (4x8GB)	DS	-	-	-	1.5	•
GeIL	GUP34GB1600C7D C(XMP)	4GB (2x2GB)	DS	-	-	7-7-7-24	1.6	•
KINGMAX	FLGE85F- C8KL9A(XMP)	2GB	SS	KINGMAX	N/A	9-9-9-28	-	•
KINGMAX	FLGF65F- C8KL9A(XMP)	4GB	DS	KINGMAX	N/A	9-9-9-28	-	•
Kingston	HX316C10FRK2/16	16GB (2x8GB)	DS	-	-	10-10-10-30	1.5	•
Kingston	KHX16009CD3K2/8 GX(XMP)	8GB (2x4GB)	DS	-	-	9-9-9-27	1.65	•
Kingston	KHX1600C9D3B1/4 G(XMP)	4GB	SS	-	-	9-9-9-27	1.65	•
Kingston	KHX1600C9D3K3/12 GX(XMP)	12GB (3x4GB)	DS	-	-	9	1.65	•
Kingston	KHX1600C9D3K3/6 GX(XMP)	6GB (3x2GB)	DS	-	-	9	1.65	•
Kingston	KHX1600C9D3K3/6 GX(XMP)	6GB (3x2GB)	DS	-	-	9	1.65	•
Kingston	KHX1600C9D3K4/1 6GX(XMP)	16GB (4x4GB)	DS	-	-	9-9-9-24	1.65	•
Kingston	KHX1600C9D3K6/24 GX(XMP)	24GB (6x4GB)	DS	-	-	9	1.65	•
Kingston	KHX1600C9D3LK2/8 GX(XMP)	8GB (2x4GB)	DS	-	-	9-9-9-24	1.35	•
Kingston	KHX1600C9D3P1K2 /8G	8GB (2x4GB)	DS	-	-	9	1.5	•
Kingston	KHX16C10B1K2/16X (XMP)	16GB (2x8GB)	DS	-	-	-	1.5	•
Kingston	KHX16C9K2/16	16GB (2x8GB)	DS	-	-	1333-9-9-9-24	1.5	•
Kingston	KHX16C9P1K2/16	16GB (2x8GB)	DS	-	-	-	1.5	•
Kingston	KVR16LN11/4(III)	4GB	SS	Kingston	D5128EC4 BPGGBU	11-11-11-28	1.35	•
Kingston	KVR16LN11/8	8GB	DS	Kingston	D5128EET BPGGBU	11-11-11-28	1.35	•
Kingston	KVR16N11/4	4GB	DS	KINGSTON	D2568JPU CPGGBU	11-11-11-28-1	-	•
Kingston	KVR16N11/4	4G	DS	Hynix	H5TQ2G83 CFRPBC	-	1.5	•
Micron	MT16JTF1G64AZ- 1G6E1	8GB	DS	Micron	D9QBJ	-	-	•
Micron	MT8JTF51264AZ- 1G6E1	4GB	SS	Micron	D9QBJ	-	-	•
Micron	MT8KTF25664AZ- 1G6M1	2GB	SS	MICRON	D9PFJ	-	-	•

(Continued on the next page)

DDR3 1600 MHz capacity

Vendors	Part No.	Size	SS/DS	Chip Brand	Chip NO.	Timing	Voltage	DIMM socket support (Optional)
MIRA	PLAF8L93B-GN2	8GB	DS	-	BJE159C 3G-M	11-11-11-28	1.5	•
PATRIOT	PV316G160C9K(XMP)	16GB (2x4GB)	SS	-	-	1600-9-9-9-24	1.5	•
PATRIOT	PV316G160C9K(XMP)	16GB (2x8GB)	SS	-	-	1600-9-9-9-24	1.5	•
SanMax	SMD-4G28N1P-16KM	4GB	SS	ELPIDA	J4208BBB G-GN-F	1600	-	•
SanMax	SMD-4G68HP-16KZ	4GB	DS	Hynix	H5TQ2G83 BFRPBC	-	1.5	•
SanMax	SMD-4G68NG-16KK	4GB	DS	ELPIDA	J2108B DBG- GN-F	-	-	•
SanMax	SMD-8G28NP-16KM	8GB	DS	ELPIDA	J4208B BBG- GN-F	1600	-	•
Silicon Power	SP002GBLTU160V02(XMP)	2GB	SS	S-POWER	20YT5NG	9-11-11-28	1.5	•
Silicon Power	SP004GBLTU160V02(XMP)	4GB	DS	S-POWER	20YT5NG	9-9-9-24	1.5	•
Silicon Power	SP004GXLYU160NSA(XMP)	4GB	SS	-	-	1600-9-9-9-27	-	•
Silicon Power	SP008GXLYU160NSA(XMP)	8GB	DS	-	-	1600-9-9-9-27	-	•
SK Hynix	HMT41GU6AFR8A-PB	8GB	DS	Hynix	H5TC4G83AFR	1600-11-11-11-28-1	-	•
SK Hynix	HMT451U6AFR8A-PB	4GB	SS	Hynix	H5TC4G83AFR	1600-11-11-11-28-1	-	•
SK Hynix	HMT451U6AFR8A-PB	4GB	SS	Hynix	H5TC4G83AFR	1600-11-11-11-28-1	-	•
Team	TED34GM1600C11BK	4GB	DS	Hynix	H5TQ2G83CFR	11-11-11-28	1.5	•
Team	TLD38G1600HC9BK(XMP)	8GB	DS	-	-	9-9-9-24	1.5	•
Transcend	TS1GLK64W6H	8GB	DS	SAMSUNG	K4B4G08460	1600-11-11-11-28-2	-	•
Transcend	TS1GLK64W6H	8GB	DS	SAMSUNG	K4B4G0846B	11-11-11-28-1	-	•
Transcend	TS512MLK64W6H	4GB	SS	SAMSUNG	K4B4G08460	1600-11-11-11-28-1	-	•
Transcend	TS512MLK64W6H	4GB	SS	SAMSUNG	K4B4G0846B	11-11-11-28-2	-	•
UMAX	84E44G93UM-16BPSYW	4GB	SS	UMAX	U2S96D30TP-16	1600-11-11-11-28	-	•
UMAX	84E48G93UM-16BPSYW	8GB	DS	UMAX	U2S96D30TP-16	1600-11-11-11-28	-	•
V-color	TD4G8C11-H11	4GB	SS	Hynix	H5TQ4G83AFR	11-11-11-28	-	•

DDR3 1333 MHz capacity

Vendors	Part No.	Size	SS/DS	Chip Brand	Chip NO.	Timing	Voltage	DIMM socket support (Optional)
AMD	AE32G1339U1-U	2GB	SS	AMD	23EY4587MB3H	-	1.5	•
AMD	AE34G1339U2-U	4GB	DS	AMD	23EY4587MB3H	-	1.5	•
Apacer	78.B1GDE.9L10C	4GB	DS	Apacer	AM5D5908C EHSBG	9	-	•
ASint	SLA302G08-EDJ1C	2GB	SS	ASint	302G08-DJ1C	-	-	•
ASint	SLA304G08-EDJ1B	4GB	SS	ASint	304G08-DJ1B	9-10-10-26	-	•
ASint	SLA304G08-EDJ6A	4GB	SS	ASint	304G08-DJ6A	1333-9-9-9-24	1.5	•
ASint	SLA304G08-EDJ6B	4GB	SS	ASint	304G08-DJ6B	1333-9-9-9-24	1.5	•
ASint	SLB304G08-EDJ1B	8GB	DS	Asint	304G08-DJ1B	9-9-9-24	-	•
BUFFALO	D3U1333-1G	1GB	SS	Elpida	J1108BFBG-DJ-F	-	-	•
BUFFALO	D3U1333-2G	2GB	DS	Elpida	J1108BFBG-DJ-F	-	-	•
BUFFALO	D3U1333-4G	4GB	DS	NANYA	NT5CB256M8BN-CG	-	-	•
CORSAIR	CMV8GX3M1A1333C9	8GB	DS	-	-	9-9-9-24	-	•
CORSAIR	CMV8GX3M2A1333C9	8GB (2x4GB)	DS	-	N/A	9-9-9-24	-	•
CORSAIR	CMX4GX3M1A1333C9 (Ver2.12)	4GB (1x4GB)	DS	-	-	9-9-9-24	1.5	•
CORSAIR	CMX4GX3M1A1333C9 (Ver5.11)	4GB (1x4GB)	DS	-	-	9-9-9-24	1.5	•
CORSAIR	CMX8GX3M2A1333C9(XMP)	8GB (2x4GB)	DS	-	-	9-9-9-24	1.5	•
G.SKILL	F3-10666CL9D-8GBXL	8GB (2x4GB)	DS	-	-	9-9-9-24	1.5	•
GelL	GG34GB1333C9DC	4GB (2x2GB)	DS	GEIL	GL1L128M88BA15B	9-9-9-24	1.3	•
GelL	GVP34GB1333C9DC	4GB (2x2GB)	DS	-	-	9-9-9-24	1.5	•
GelL	GVP38GB1333C9DC	8GB (2x4GB)	DS	-	-	9-9-9-24	1.5	•
innodisk	M3UN-2GHJBC09	2GB	SS	Hynix	H5TQ2G83C FRH9C	9-9-9-24	-	•
innodisk	M3UN-4GHJAC09	4GB	DS	Hynix	H5TQ2G83C FRH9C	9-9-9-24	-	•
KINGMAX	FLFE85F-C8KL9	2GB	SS	KINGMAX	KFC8FNLBF-GXX-12A	-	-	•
KINGMAX	FLFE85F-C8KL9	2GB	SS	KINGMAX	KFC8FNLXF-DXX-15A	-	-	•
KINGMAX	FLFF65F-C8KL9	4GB	DS	KINGMAX	KFC8FNLXF-DXX-15A	-	-	•
Kingston	KVR1333D3E9S/4G	4GB	DS	Elpida	J2108ECSE-DJ-F	9	1.5	•
Kingston	KVR1333D3N9H/4G	4GB	DS	ELPIDA	J2108BDBG-GN-F	-	1.5	•
Kingston	KVR1333D3N9S/4G	4GB	SS	ELPIDA	J4208BBBG-GN-F	-	1.5	•

(Continued on the next page)

DDR3 1333 MHz capacity

Vendors	Part No.	Size	SS/ DS	Chip Brand	Chip NO.	Timing	Voltage	DIMM socket support (Optional)
MACH XTREME	MXD3U133316GQ	16GB (4x4GB)	DS	-	-	-	-	•
MACH XTREME	MXD3V13332GS	2GB	SS	Mach Xtreme	C2S46D30-D313	-	-	•
Micron	MT8JTF25664AZ- 1G4M1	2GB	SS	MICRON	D9PFJ	-	-	•
RiDATA	C304627CB1AG22Fe	2GB	DS	RiDATA	C304627CB1A G22Fe	9	-	•
RiDATA	E304459CB1AG32Cf	4GB	DS	RiDATA	E304459CB1A G32Cf	9	-	•
Silicon Power	SP001GBLTU133S02	1GB	SS	S-POWER	10YT3E5	9	-	•
Silicon Power	SP002GBLTU133V02	2GB	SS	S-POWER	20YT3NG	9-9-9-24	-	•
Silicon Power	SP004GBLTU133V02	4GB	DS	S-POWER	20YT3NG	9-9-9-24	-	•
UMAX	84E44G93UM- 13BPSYW	4GB	SS	UMAX	U2S96D30TP-13	1333-9-9-9-24	-	•
UMAX	84E48G93UM- 13BPSYW	8GB	DS	UMAX	U2S96D30TP-13	1333-9-9-9-24	-	•



- Side(s): SS - Single-sided DS - Double-sided DIMMs
- DIMM socket support:

- 1 Supports one (1) module inserted into any slot as Single-channel memory configuration. We suggest that you install the module into A1 slot.
- 2 Supports two (2) modules inserted into the red slots as one pair of Dual-channel memory configuration.



- ASUS exclusively provides hyper DIMM support function.
- Hyper DIMM support is subject to the physical characteristics of individual CPUs. Load the X.M.P. settings in the BIOS for the hyper DIMM support.
- Visit the ASUS website for the latest QVL.

1.2.5 Expansion slot



Unplug the power cord before adding or removing expansion card. Failure to do so may cause you physical injury and damage motherboard components.

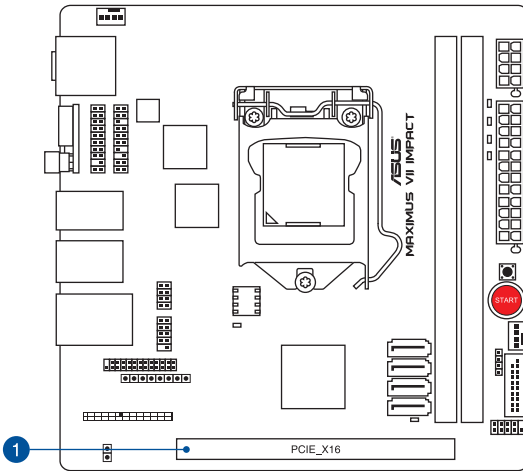

Slot No.	Slot Description
1	PCIe 3.0/2.0 x16 slot



The PCIe 3.0 x16 slot runs at x8 speed when a device is inserted to the M.2 slot of the mPCIe Combo IV card.

IRQ assignments for this motherboard

	A	B	C	D	E	F	G	H
PCIEx16	shared	-	-	-	-	-	-	-
I.G.F.X.	shared	-	-	-	-	-	-	-
Intel LAN Controller	-	-	-	-	shared	-	-	-
SATA #0	-	shared	-	-	-	-	-	-
SATA #1	-	shared	-	-	-	-	-	-
High Definition Audio	-	-	-	-	-	-	shared	-
EHCI# 0 (USB 2.0)	-	-	-	-	-	-	-	shared
EHCI# 1 (USB 2.0)	-	-	-	-	shared	-	-	-
XHCI (USB 3.0)	-	-	-	-	-	shared	-	-
Wi-Fi	-	-	-	shared	-	-	-	-

1.2.6 Onboard buttons

Onboard buttons allow you to fine-tune performance when working on a bare or open-case system. This is ideal for overclockers and gamers who continually change settings to enhance system performance.

1. Power-on button

The motherboard comes with a power-on button that allows you to power up or wake up the system. The button also lights up when the system is plugged to a power source indicating that you should shut down the system and unplug the power cable before removing or installing any motherboard component.

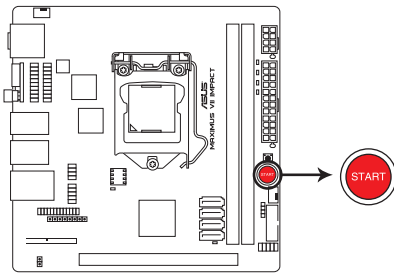

MAXIMUS VII IMPACT Power on button

2. Reset button

Press the reset button to reboot the system.

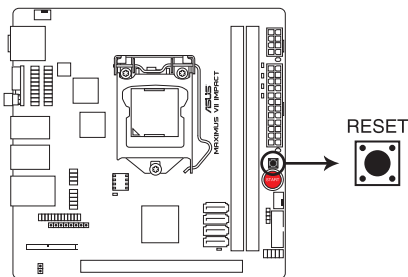

MAXIMUS VII IMPACT Reset button

3. KeyBot button (KEYBOT)

The Keybot button allows you to configure and assign actions to your keyboard for a specific task. Press this button to activate the KeyBot feature.

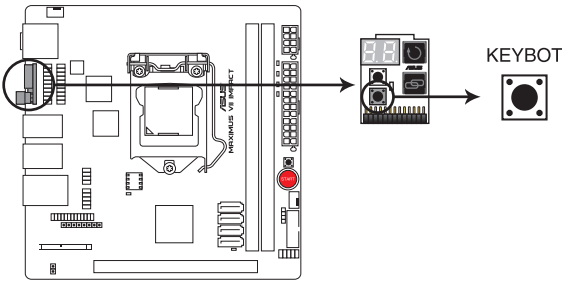

MAXIMUS VII IMPACT KEYBOT button



- The KeyBot feature only supports USB keyboards connected on the designated USB port. For the location of the KeyBot USB port, refer to section 2.3.1 **Rear I/O connection** of this user guide.
- The KEYBOT_LED near the KEYBOT button lights up if the Keybot function is enabled.
- For more information about the KeyBot feature, refer to section 4.10 **KeyBot** of this user guide.

4. Sonic SoundStage button (SOUNDSTAGE)

The Sonic SoundStage button allows you to set a preset sounds for your games. Press this button to activate the Sonic SoundStage feature.

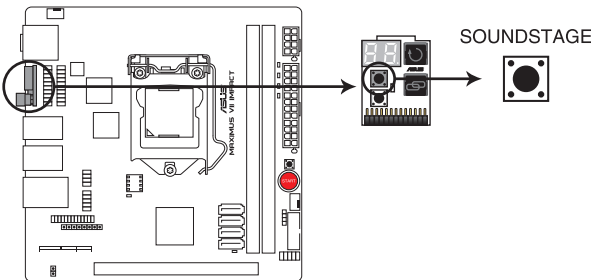

MAXIMUS VII IMPACT SOUNDSTAGE button



- The debug code on the Q-Code LED shows the current Sonic SoundStage profile when you press the Sonic SoundStage button. There are four presets that have been implemented: (01)FPS, (02)Racing, (03)Fighting, (04)Sports, and (dE)default.
- For more information about Sonic SoundStage, refer to section 4.7.3 **Sonic SoundStage** of this user guide.

1.2.7 Onboard LEDs

1. Hard Disk LED

The hard disk LED is designed to indicate the hard disk activity. It blinks when data is being written into or read from the hard disk drive. The LED does not light up when there is no hard disk drive connected to the motherboard or when the hard disk drive does not function.

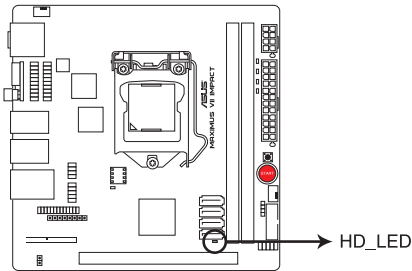

MAXIMUS VII IMPACT Hard Disk LED

2. Q LED

Q LEDs check key components (CPU, DRAM, VGA card, and booting devices) in sequence during motherboard booting process. If an error is found, the corresponding LED continues flashing until the problem is solved. This user-friendly design provides an intuitive way to locate the root problem within seconds.

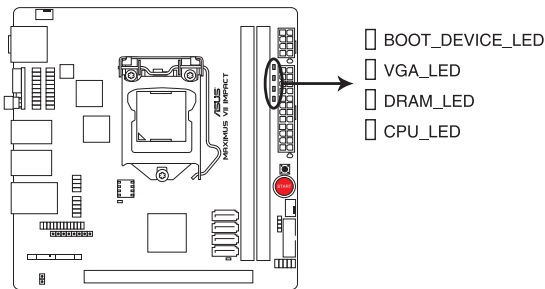

**MAXIMUS VII IMPACT CPU/ DRAM/
VGA/ BOOT_DEVICE LED**

3. USB BIOS Flashback LED

This LED flashes when the BIOS is updating and turns off after the BIOS update.

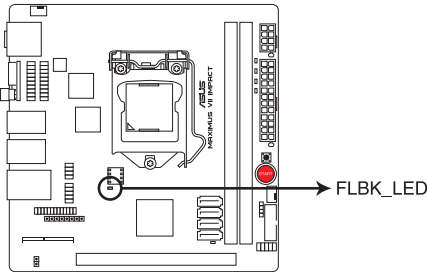

MAXIMUS VII IMPACT FLBK_LED



For more information on how to update the BIOS, refer to Chapter 2 of this user guide.

4. KeyBot LED (KEYBOT_LED)

This LED lights up when you activated the KeyBot function by pressing the onboard KeyBot button, or when enabling the KeyBot function via the KeyBot software.

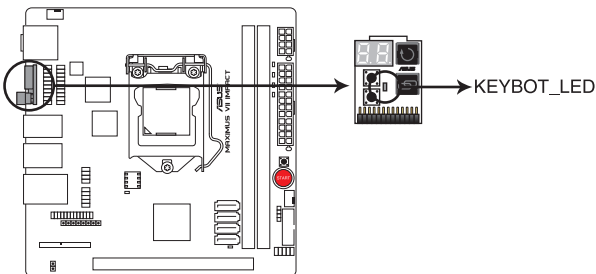

MAXIMUS VII IMPACT KEYBOT_LED

5. Q-Code LEDs

The Q-Code LED design provides you with a 2-digit error code that displays the system status. Refer to the Q-Code table on the next page for details.

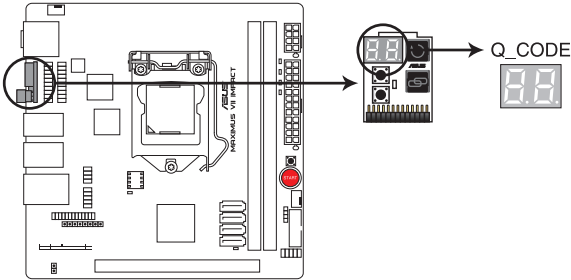

MAXIMUS VII IMPACT Q-Code LED



- The Q-Code LED automatically displays the POST code upon boot and the CPU temperature upon entering the operating system.
- The Q-Code LED also shows the Sonic SoundStage profile when Sonic SoundStage button is pressed.
- For more information of the Sonic SoundStage function, refer to section **1.2.6 Onboard buttons**.

Q-Code table

Code	Description
00	Not used
01	Power on. Reset type detection (soft/hard).
02	AP initialization before microcode loading
03	System Agent initialization before microcode loading
04	PCH initialization before microcode loading
06	Microcode loading
07	AP initialization after microcode loading
08	System Agent initialization after microcode loading
09	PCH initialization after microcode loading
0B	Cache initialization
0C – 0D	Reserved for future AMI SEC error codes
0E	Microcode not found
0F	Microcode not loaded
10	PEI Core is started
11 – 14	Pre-memory CPU initialization is started
15 – 18	Pre-memory System Agent initialization is started
19 – 1C	Pre-memory PCH initialization is started
2B – 2F	Memory initialization
30	Reserved for ASL (see ASL Status Codes section below)
31	Memory Installed
32 – 36	CPU post-memory initialization
37 – 3A	Post-Memory System Agent initialization is started
3B – 3E	Post-Memory PCH initialization is started
4F	DXE IPL is started

(continued on the next page)

Q-Code table

Code	Description
50 – 53	Memory initialization error. Invalid memory type or incompatible memory speed
54	Unspecified memory initialization error
55	Memory not installed
56	Invalid CPU type or Speed
57	CPU mismatch
58	CPU self test failed or possible CPU cache error
59	CPU micro-code is not found or micro-code update is failed
5A	Internal CPU error
5B	Reset PPI is not available
5C – 5F	Reserved for future AMI error codes
E0	S3 Resume is started (S3 Resume PPI is called by the DXE IPL)
E1	S3 Boot Script execution
E2	Video repost
E3	OS S3 wake vector call
E4 – E7	Reserved for future AMI progress codes
E8	S3 Resume Failed
E9	S3 Resume PPI not Found
EA	S3 Resume Boot Script Error
EB	S3 OS Wake Error
EC – EF	Reserved for future AMI error codes
F0	Recovery condition triggered by firmware (Auto recovery)
F1	Recovery condition triggered by user (Forced recovery)
F2	Recovery process started
F3	Recovery firmware image is found
F4	Recovery firmware image is loaded
F5 – F7	Reserved for future AMI progress codes
F8	Recovery PPI is not available

(continued on the next page)

Q-Code table

Code	Description
F9	Recovery capsule is not found
FA	Invalid recovery capsule
FB – FF	Reserved for future AML error codes
60	DXE Core is started
61	NVRAM initialization
62	Installation of the PCH Runtime Services
63 – 67	CPU DXE initialization is started
68	PCI host bridge initialization
69	System Agent DXE initialization is started
6A	System Agent DXE SMM initialization is started
6B – 6F	System Agent DXE initialization (System Agent module specific)
70	PCH DXE initialization is started
71	PCH DXE SMM initialization is started
72	PCH devices initialization
73 – 77	PCH DXE Initialization (PCH module specific)
78	ACPI module initialization
79	CSM initialization
7A – 7F	Reserved for future AMI DXE codes
90	Boot Device Selection (BDS) phase is started
91	Driver connecting is started
92	PCI Bus initialization is started
93	PCI Bus Hot Plug Controller Initialization
94	PCI Bus Enumeration
95	PCI Bus Request Resources
96	PCI Bus Assign Resources
97	Console Output devices connect
98	Console input devices connect
99	Super IO Initialization
9A	USB initialization is started
9B	USB Reset

(continued on the next page)

Q-Code table

Code	Description
9C	USB Detect
9D	USB Enable
9E – 9F	Reserved for future AMI codes
A0	IDE initialization is started
A1	IDE Reset
A2	IDE Detect
A3	IDE Enable
A4	SCSI initialization is started
A5	SCSI Reset
A6	SCSI Detect
A7	SCSI Enable
A8	Setup Verifying Password
A9	Start of Setup
AA	Reserved for ASL (see ASL Status Codes section below)
AB	Setup Input Wait
AC	Reserved for ASL (see ASL Status Codes section below)
AD	Ready To Boot event
AE	Legacy Boot event
AF	Exit Boot Services event
B0	Runtime Set Virtual Address MAP Begin
B1	Runtime Set Virtual Address MAP End
B2	Legacy Option ROM Initialization
B3	System Reset
B4	USB hot plug
B5	PCI bus hot plug
B6	Clean-up of NVRAM
B7	Configuration Reset (reset of NVRAM settings)
B8– BF	Reserved for future AMI codes
D0	CPU initialization error
D1	System Agent initialization error

(continued on the next page)

Q-Code table

Code	Description
D2	PCH initialization error
D3	Some of the Architectural Protocols are not available
D4	PCI resource allocation error. Out of Resources
D5	No Space for Legacy Option ROM
D6	No Console Output Devices are found
D7	No Console Input Devices are found
D8	Invalid password
D9	Error loading Boot Option (LoadImage returned error)
DA	Boot Option is failed (StartImage returned error)
DB	Flash update is failed
DC	Reset protocol is not available

ACPI/ASL Checkpoints

Code	Description
0x01	System is entering S1 sleep state
0x02	System is entering S2 sleep state
0x03	System is entering S3 sleep state
0x04	System is entering S4 sleep state
0x05	System is entering S5 sleep state
0x10	System is waking up from the S1 sleep state
0x20	System is waking up from the S2 sleep state
0x30	System is waking up from the S3 sleep state
0x40	System is waking up from the S4 sleep state
0xAC	System has transitioned into ACPI mode. Interrupt controller is in PIC mode.
0xAA	System has transitioned into ACPI mode. Interrupt controller is in APIC mode.

1.2.8 Internal connectors

1. Intel® Z97 Serial ATA 6 Gb/s connectors (7-pin SATA6G_1-4 [red])

These connectors connect to Serial ATA 6 Gb/s hard disk drives via Serial ATA 6 Gb/s signal cables.

If you installed Serial ATA hard disk drives, you can create a RAID 0, 1, 5, and 10 configuration with the Intel® Rapid Storage Technology through the onboard Intel® Z97 chipset.

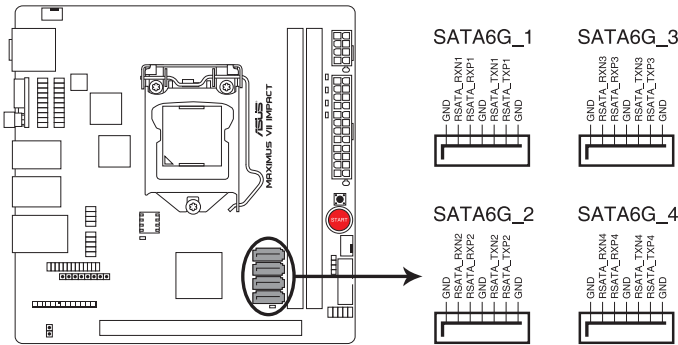

MAXIMUS VII IMPACT Intel® SATA 6 Gb/s connectors

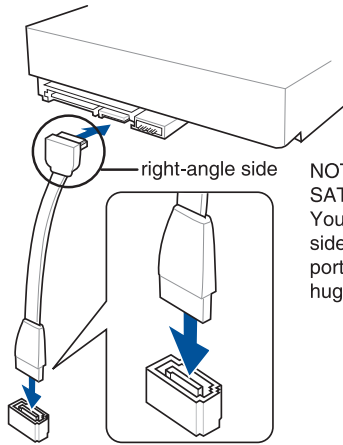

NOTE: Connect the right-angle side of SATA signal cable to SATA device. You may also connect the right-angle side of SATA cable to the onboard SATA port to avoid mechanical conflict with huge graphics cards.



- These connectors are set to [AHCI Mode] by default. If you intend to create a Serial ATA RAID set using these connectors, set the SATA Mode item in the BIOS to [RAID Mode]. Refer to section 3.6.3 PCH Storage Configuration for details.
- When using NCQ, set the SATA Mode in the BIOS to [AHCI Mode]. Refer to section 3.6.3 PCH Storage Configuration for details.

2. USB 3.0 connector (20-1 pin USB3_12)

This connector allows you to connect a USB 3.0 module for additional USB 3.0 front or rear panel ports. With an installed USB 3.0 module, you can enjoy all the benefits of USB 3.0 including faster data transfer speeds of up to 5 Gb/s, faster charging time for USB-chargeable devices, optimized power efficiency, and backward compatibility with USB 2.0.

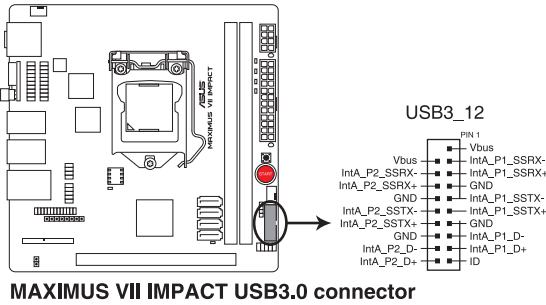

MAXIMUS VII IMPACT USB3.0 connector



- The USB 3.0 module is purchased separately.
- These connectors are based on xHCI specification. We recommend you to install the related driver to fully use the USB 3.0 ports under Windows® 7, Windows® 8, and Windows® 8.1.
- The plugged USB 3.0 device may run on xHCI or EHCI mode depending on the operating system's setting.

3. USB 2.0 connectors (10-1 pin USB1213)

These connectors are for USB 2.0 ports. Connect the USB module cable to any of these connectors, then install the module to a slot opening at the back of the system chassis. These USB connectors comply with USB 2.0 specification that supports up to 480 MBps connection speed.

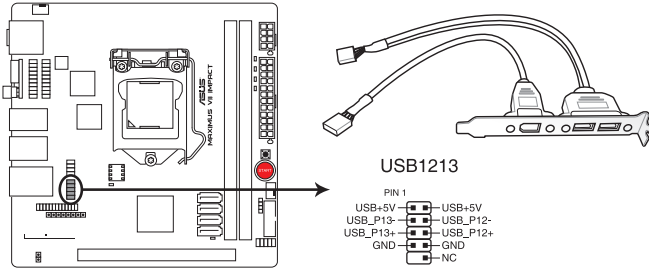

MAXIMUS VII IMPACT USB2.0 connector



Never connect a 1394 cable to the USB connectors. Doing so will damage the motherboard!



The USB 2.0 ports (USB1213) at mid-board share with ROG extension (ROG_EXT) port.

4. CPU and chassis fan connectors (4-pin CPU_FAN; 4-pin CHA_FAN1)

Connect the fan cables to the fan connectors on the motherboard, ensuring that the black wire of each cable matches the ground pin of the connector.

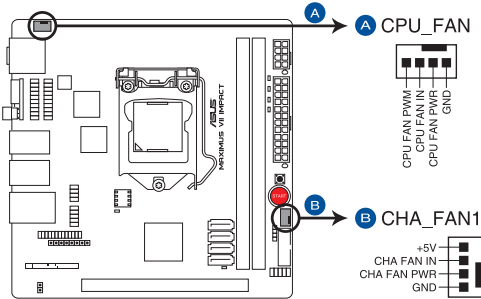

MAXIMUS VII IMPACT Fan connectors



- DO NOT forget to connect the fan cables to the fan connectors. Insufficient air flow inside the system may damage the motherboard components. These are not jumpers! Do not place jumper caps on the fan connectors!
- Ensure to fully insert the 4-pin CPU fan cable to the CPU fan connector.



The CPU_FAN connector supports the CPU fan of maximum 1A (12 W) fan power.

5. ATX power connectors (24-pin EATXPWR; 8-pin EATX12V)

These connectors are for ATX power supply plugs. The power supply plugs are designed to fit these connectors in only one orientation. Find the proper orientation and push down firmly until the connectors completely fit.

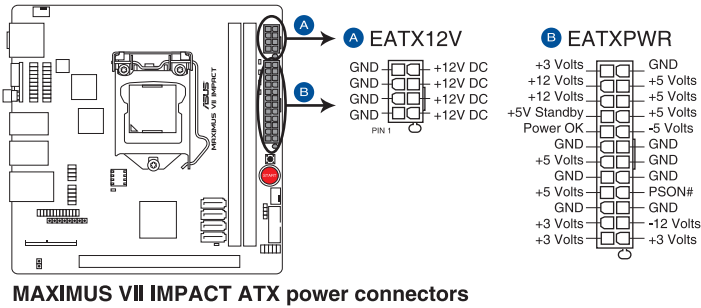

- For a fully configured system, we recommend that you use a power supply unit (PSU) that complies with ATX 12 V Specification 2.0 (or later version) and provides a minimum power of 350 W.
- Do not forget to connect the 4-pin/8-pin EATX12 V power plug. Otherwise, the system will not boot.
- We recommend that you use a PSU with a higher power output when configuring a system with more power-consuming devices. The system may become unstable or may not boot up if the power is inadequate.

6. Front panel and speaker connectors (10-1 pin PANEL; 4 pin SPEAKER)

These connectors support several chassis-mounted functions.

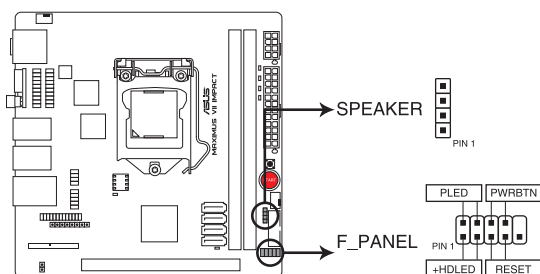

MAXIMUS VII IMPACT SPEAKER & F_PANEL connectors

- **System power LED (2-pin PLED)**

This 2-pin connector is for the system power LED. Connect the chassis power LED cable to this connector. The system power LED lights up when you turn on the system power, and blinks when the system is in sleep mode.

- **Hard disk drive activity LED (2-pin HDD_LED)**

This 2-pin connector is for the HDD Activity LED. Connect the HDD Activity LED cable to this connector. The HDD LED lights up or flashes when data is read from or written to the HDD.

- **System warning speaker (4-pin SPEAKER)**

This 4-pin connector is for the chassis-mounted system warning speaker. The speaker allows you to hear system beeps and warnings.

- **ATX power button/soft-off button (2-pin PWRBTN)**

This connector is for the system power button. Pressing the power button turns the system on or puts the system in sleep or soft-off mode depending on the BIOS settings. Pressing the power button for more than four seconds while the system is ON turns the system OFF.

- **Reset button (2-pin RESET)**

This 2-pin connector is for the chassis-mounted reset button for system reboot without turning off the system power.

7. ROG Extension connector (18-1 pin ROG_EXT)

This connector is for the OC Panel, Front Base, and other ROG devices.

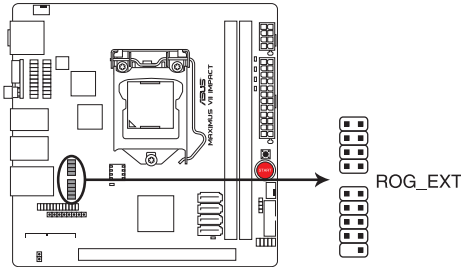

MAXIMUS VII IMPACT ROG_EXT connectors



Two (2) USB 2.0 ports (USB1213) at mid-board share with ROG extension (ROG_EXT) port.



- The OC Panel and Front Base are purchased separately.
- Visit www.asus.com for more information about the OC Panel and Front Base.

8. TPM connector (20-1 pin TPM)

This connector supports a Trusted Platform Module (TPM) system, which securely store keys, digital certificates, passwords and data. A TPM system also helps enhance the network security, protects digital identities, and ensures platform integrity.

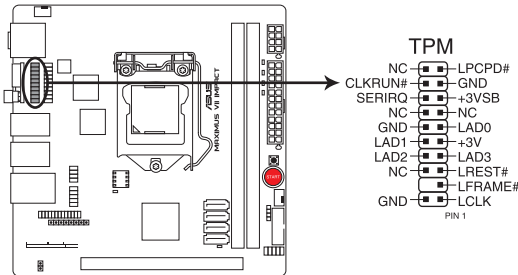

MAXIMUS VII IMPACT TPM connector

9. **mPCIe Combo IV connector (50-1 pin MPCIE_COMBO_IV)**

This connector is for the bundled mPCIe Combo IV card that offers expandability and connectivity solutions for an optimal system performance.

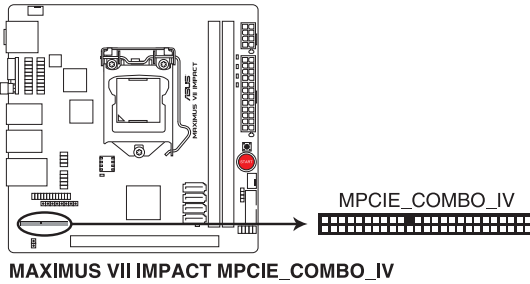

Refer to section 2.1.11 mPCIe Combo IV card installation for more details.

10. **SupremeFX Impact II connector (20-1 pin SFX_IMPACT_II)**

This connector is for the bundled SupremeFX Impact II audio card that allows you to connect audio devices such as speakers, microphone, or headset. It also has the front panel audio connector for a chassis-mounted front panel audio I/O module. Connect your bundled SupremeFX Impact II audio card to this connector.

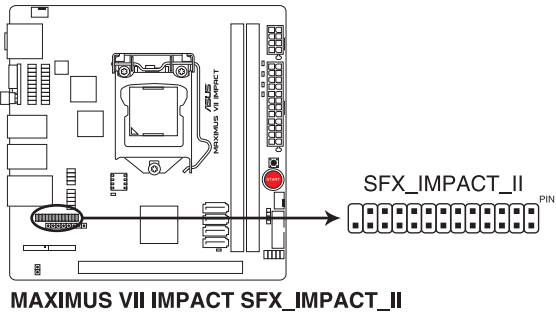

Use only the bundled SupremeFX II audio card to install to the SupremeFX II connector of your motherboard. Other SupremeFX audio cards may fit but they are not compatible with the SupremeFX II connector. For installation details, refer to section 2.1.3 **SupremeFX Impact II audio card installation**.



For details regarding the SupremeFX II Impact audio card, refer to section 1.2.10 **SupremeFX Impact II audio card**.

11. Impact_CoolHub connector (20-pin IMPACT_COOLHUB)

This connector is for the bundled Impact CoolHub card. Install the Impact CoolHub card to this connector to install Chassis fans 3 and 4.

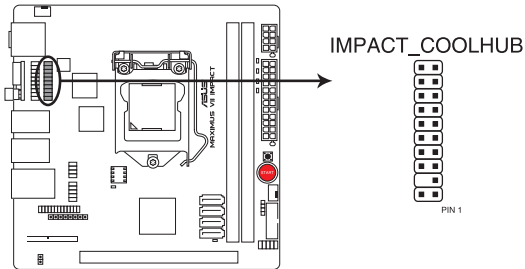

MAXIMUS VII IMPACT IMPACT_COOLHUB connector



Refer to section 2.1.10 **Impact CoolHub Card installation** for more details.

1.2.9 Probel

The ROG Probel allows you to detect your system's current voltage and OC settings. Use a multimeter to measure the Probel points even during overclocking.

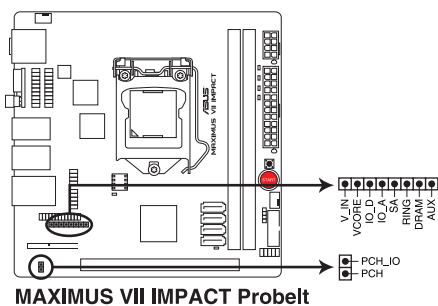

Using Probel

You can connect the multimeter to Probel points on your motherboard as shown on the illustration below.

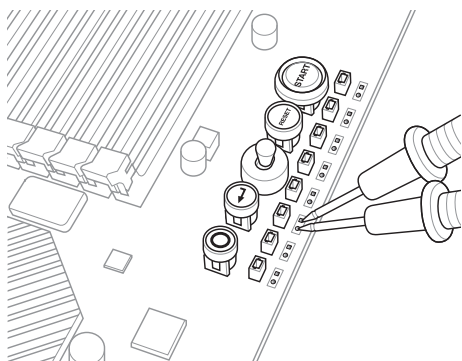

The illustration above is for reference only. The motherboard layout and Probel measure points may differ by models.

1.2.10 SupremeFX Impact II audio card

The bundled SupremeFX Impact II audio card integrates all the audio functions of your motherboard. It consists of three (3) audio ports to connect your audio devices and a front panel audio connector (AAFP) for the front panel audio solution.

1. Front panel audio connector (10-1 pin AAFP)

This connector is for a chassis-mounted front panel audio I/O module that supports either HD Audio or legacy AC'97 audio standard. Connect one end of the front panel audio I/O module cable to this connector.

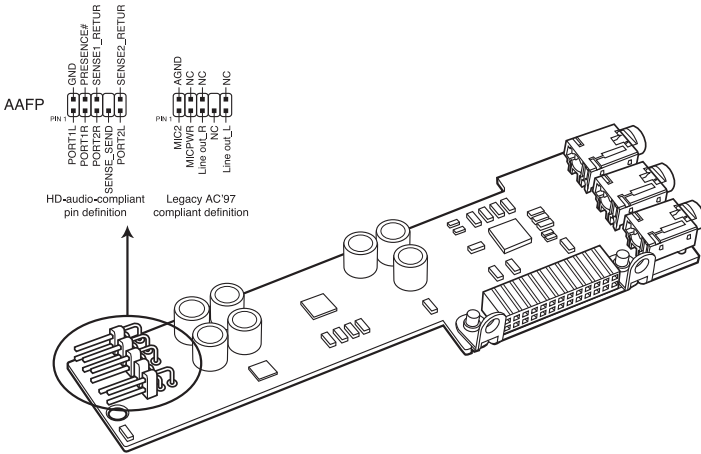

SupremeFX Impact II Analog front panel connector



- We recommend that you connect a high-definition front panel audio module to this connector to avail of the motherboard's high-definition audio capability.
- If you want to connect a high-definition or an AC'97 front panel audio module to this connector, set the **Front Panel Type** item in the BIOS setup to **[HD Audio]** or **[AC97]**. Refer to section **3.6.4 System Agent Configuration** for more details.

2. Audio ports

These high-definition audio ports allow you to connect your audio devices such as high-definition speakers, microphone, or a headset for a superior audio experience.

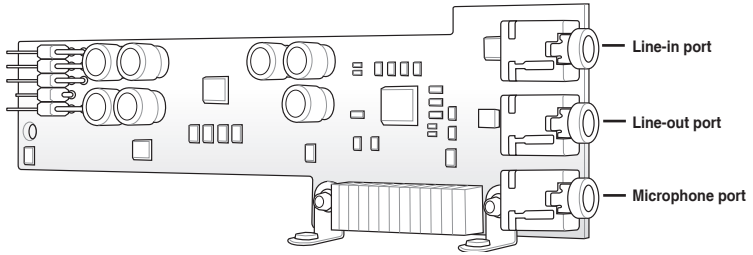

To know more about channel configurations and connecting audio devices, refer to section **2.3 Motherboard rear and audio connections**.

Basic Installation

2

2.1 Building your PC system

2.1.1 Motherboard installation



The diagrams in this section are for reference only. The motherboard layout may vary with models.

1. Install the ASUS Q-Shield to the chassis rear I/O panel.

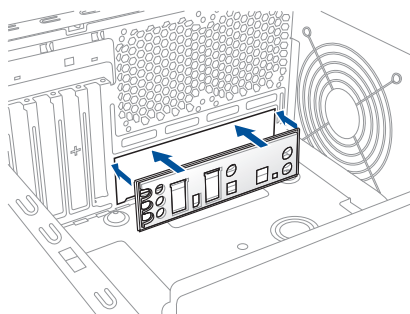

2. Place the motherboard into the chassis, ensuring that its rear I/O ports are aligned to the chassis' rear I/O panel.

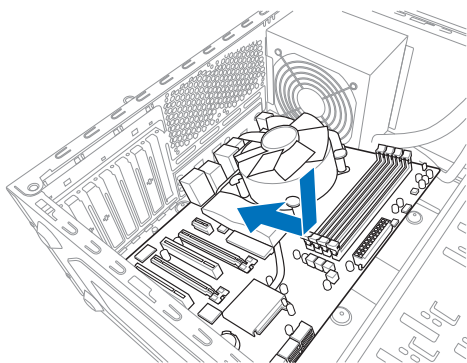

3. Place the motherboard into the chassis, ensuring that its rear I/O ports are aligned to the chassis' rear I/O panel.

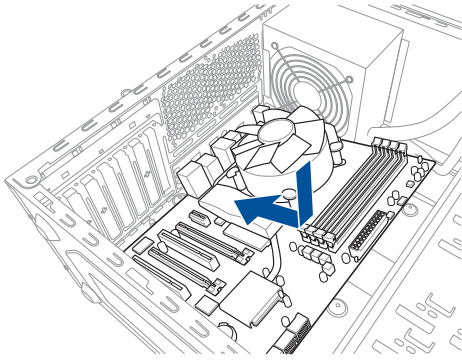

4. Place four screws into the holes indicated by circles to secure the motherboard to the chassis.

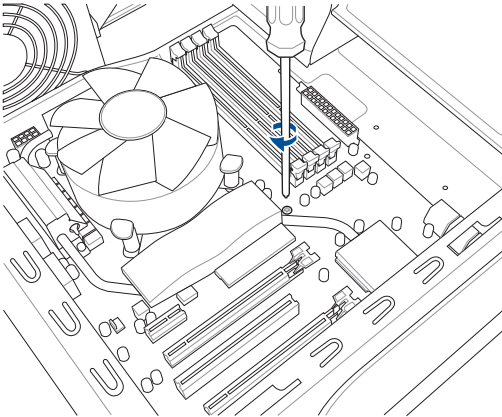

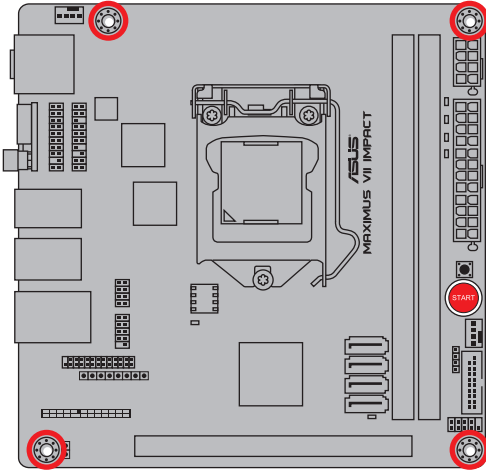

DO NOT overtighten the screws! Doing so can damage the motherboard.

2.1.2 CPU installation



Ensure that you install the correct CPU designed for LGA1150 socket only. DO NOT install a CPU designed for LGA1155 and LGA1156 sockets on the LGA1150 socket.

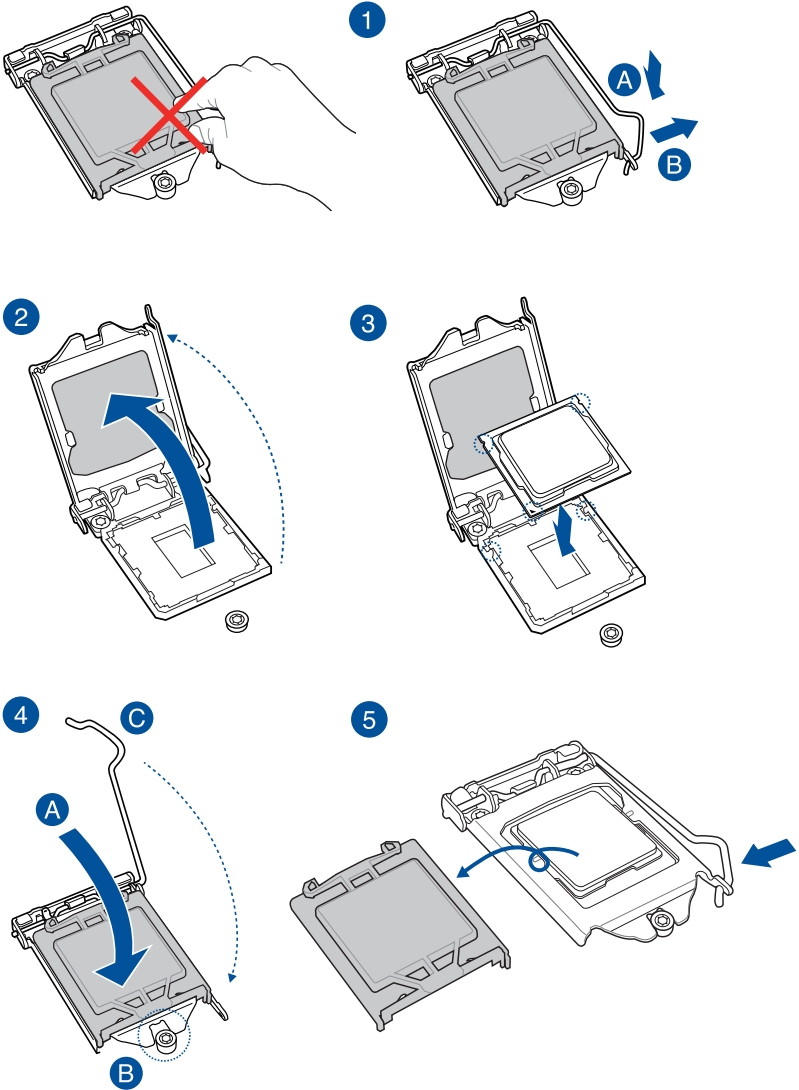

2.1.3 SupremeFX Impact II audio card installation



The illustrations in this section are for reference only. The motherboard layout may vary with models.

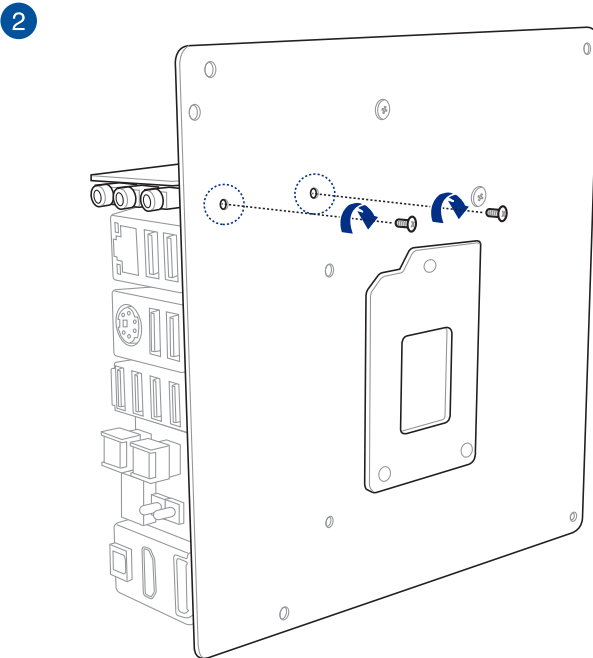
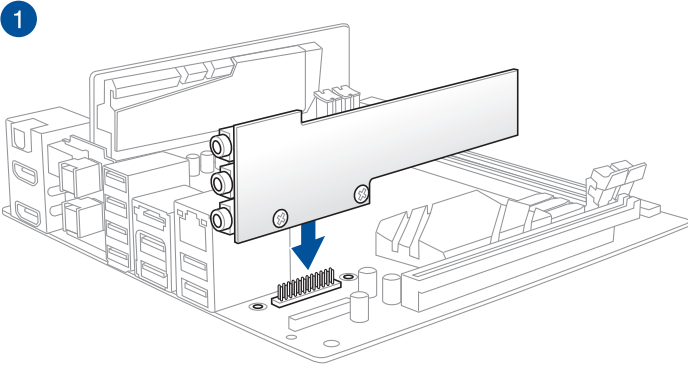

2.1.4 DIMM installation

1

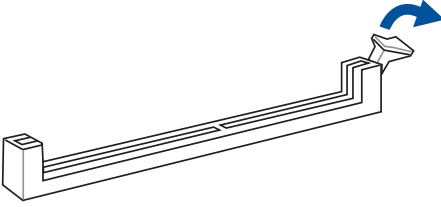

2

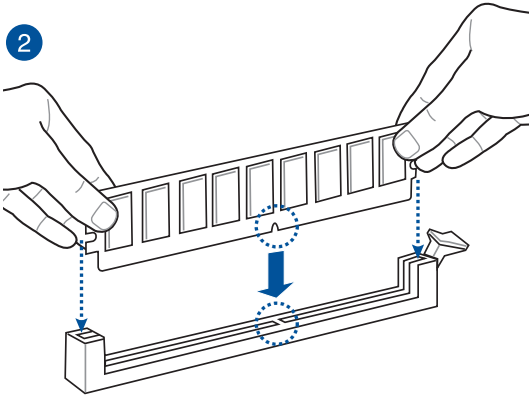

3

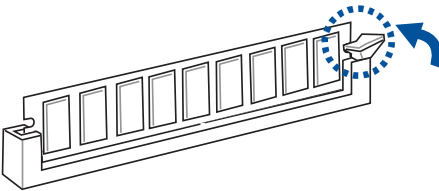

To remove a DIMM

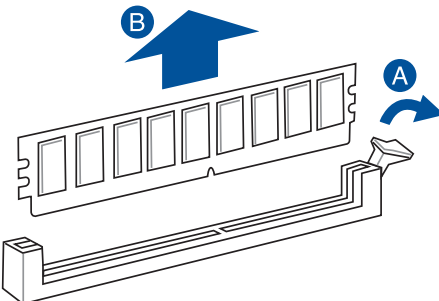

2.1.5 CPU heatsink and fan assembly installation

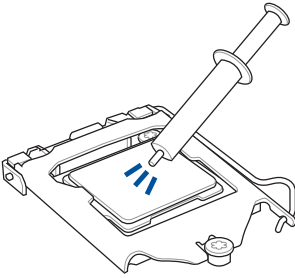

Apply the Thermal Interface Material to the CPU heatsink and CPU before you install the heatsink and fan, if necessary.

To install the CPU heatsink and fan assembly

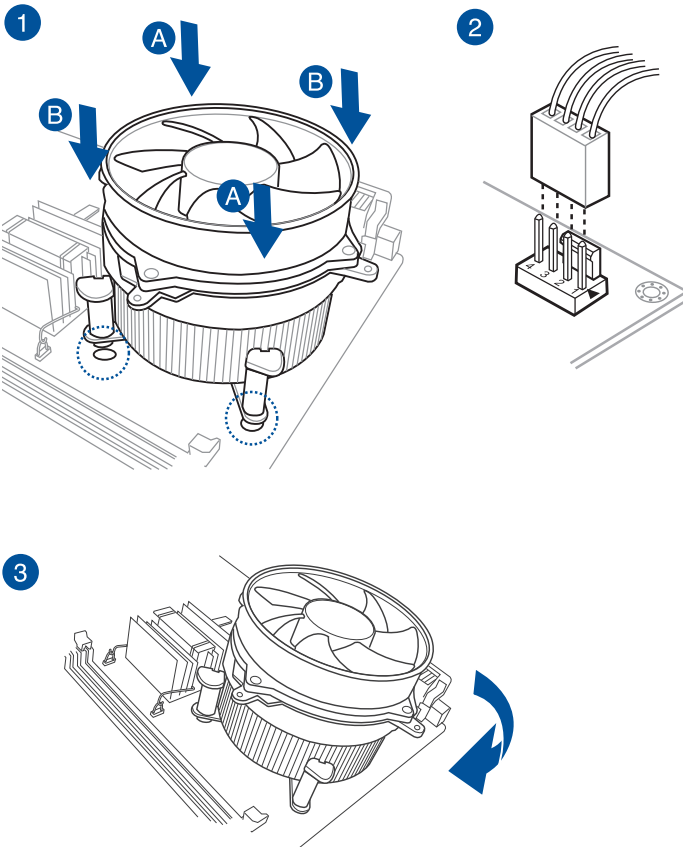

4

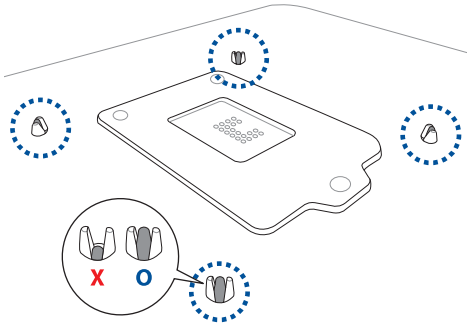

OR

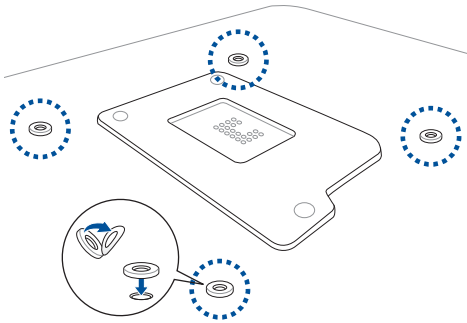

If you have difficulty in installing a CPU fan with a cooler backplate of varying design, we suggest to use the bundled plastic washers to give space between the motherboard and the backplate. Peel of the adhesive's cover and attach them to the screw holes at the back of the motherboard, as shown.

To uninstall the CPU heatsink and fan assembly

1

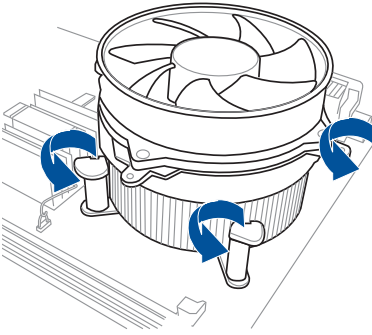

2

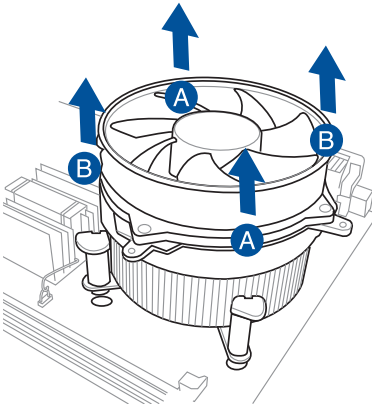

2.1.6 ATX Power connection

1

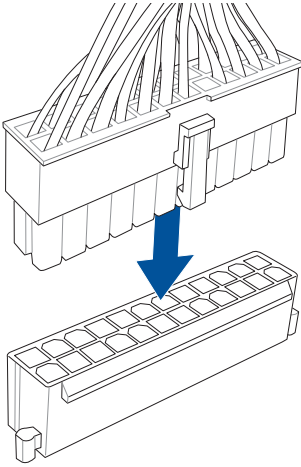

2

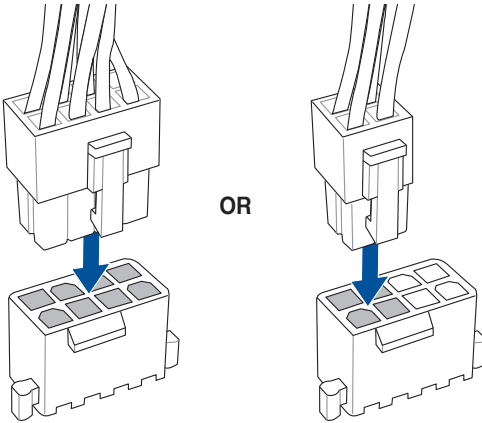

2.1.7 SATA device connection

1

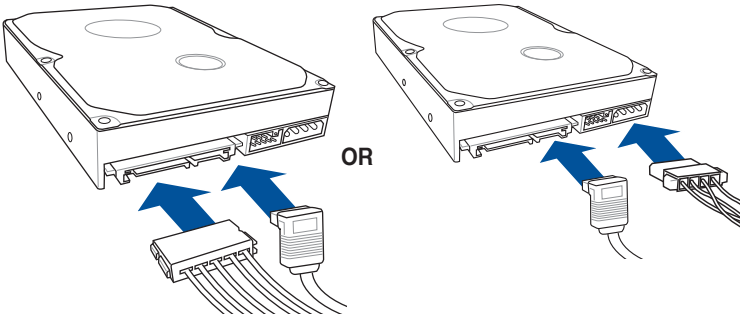

2

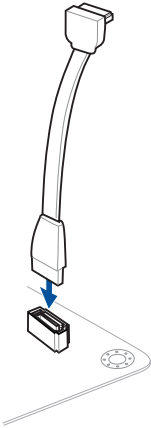

2.1.8 Front I/O Connector

To install USB 2.0 connector

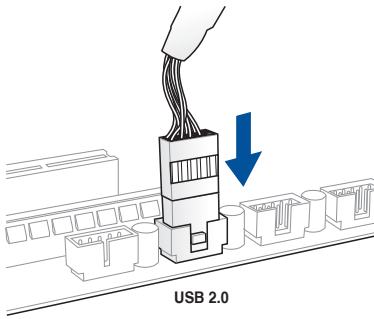

To install front panel audio connector

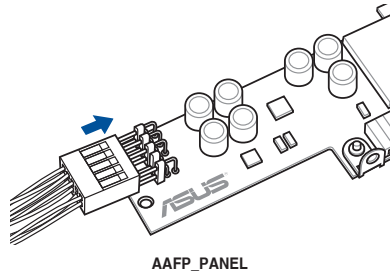

To install USB 3.0 connector

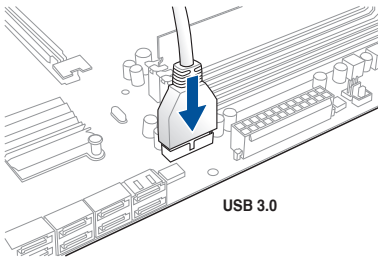

2.1.9 Expansion Card installation

To install PCIe x16 cards

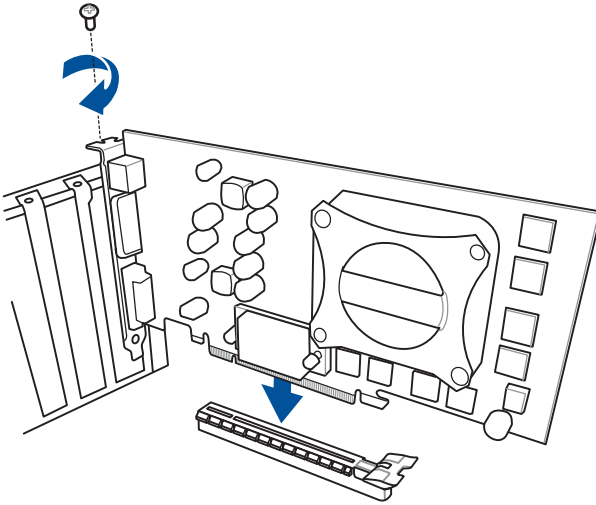

2.1.10 Impact CoolHub Card installation

To install Impact CoolHub Card

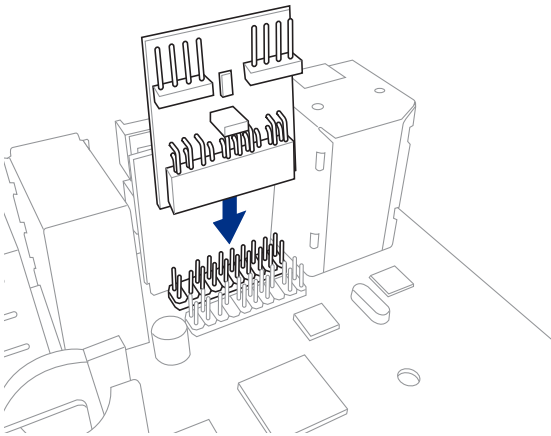

2.1.11 mPCIe Combo IV card installation

ROG mPCIe Combo IV card offers expandability solutions with the latest connectivity standards via the proprietary connector onboard. It provides mini PCI Express 2.0 plus USB 2.0 which is bundled with Wi-Fi and Bluetooth module and features the M.2 (NGFF) slot for installing an SSD card.



- The mPCIe Combo IV card supports 26.8mm x 30mm half-sized mPCIe module on one side and M.2 (NGFF) Type 2242 (22mm x 42mm), 2260 (22mm x 60mm), 2280 (22mm x 80mm), or 22110 (22mm x 110mm) SSD cards for slot B on the other side.
- The M.2 (NGFF) SSD card is purchased separately.
- The mPCIe Combo IV card supports the PCIe interface only.

Installing the M.2 (NGFF) SSD module

To install M.2 (NGFF) SSD module:

1. Remove the two short screws at the back of the mPCIe Combo IV card metal cover.

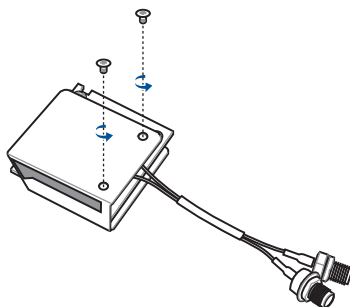

2. Remove the long screw at the front, then remove the metal cover.

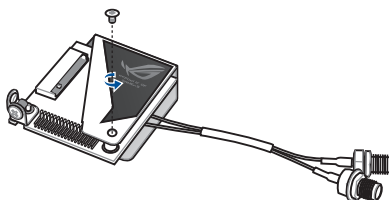

3. Align and insert the M.2 (NGFF) SSD module into the M.2 slot.

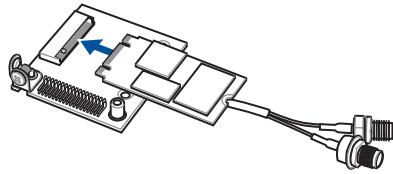

The M.2 (NGFF) SSD module fits in one orientation only. If it does not fit, try reversing it.

4. Replace the metal cover and secure the back of the metal cover with the two short screws that you removed in step 1.

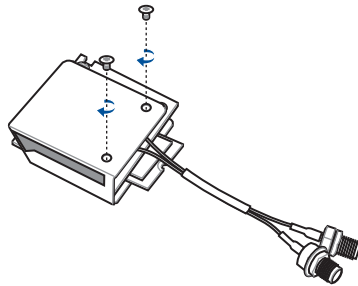

5. Secure the front of the metal cover with the long screw that you removed in step 2.

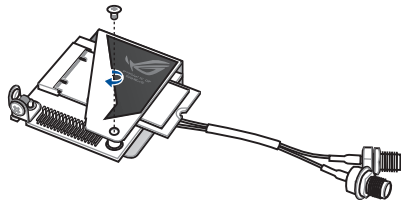

Installing the mPCIe Combo IV card

To install the mPCIe Combo IV card to your motherboard:

1. Remove the black screw near the 50-1 pin connector.

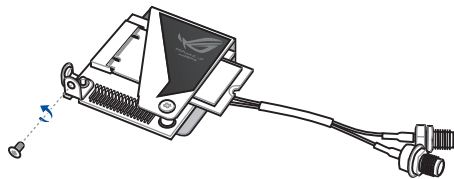

2. Locate the MPCIE_COMBO_IV connector on the motherboard then align and insert the mPCIe Combo IV card to the MPCIE_COMBO_IV connector.

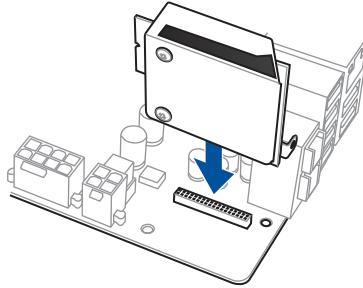

- The mPCIe Combo IV fits in one orientation only.
- The motherboard layout varies with models.



Insert the mPCIe Combo IV carefully to prevent damage to the card, connector pins, or to the motherboard.

3. Secure the mPCIe Combo IV card either to the motherboard or the rear I/O shield using the black screw that you removed in step 1.

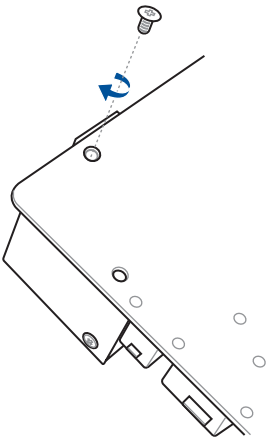

OR

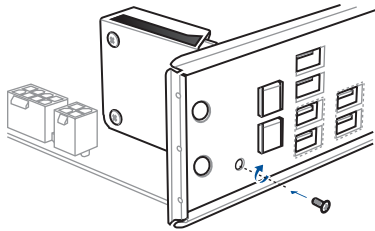

The motherboard layout varies with models.

Installing the Wi-Fi antenna connector

To install the Wi-Fi antenna connector:

1. Remove the bolt from the Wi-Fi antenna connector but leave the washer on the connector.

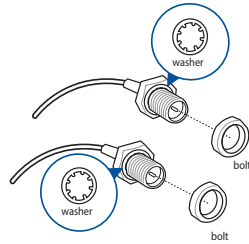

2. Insert the connector into the I/O shield's Wi-Fi port hole.

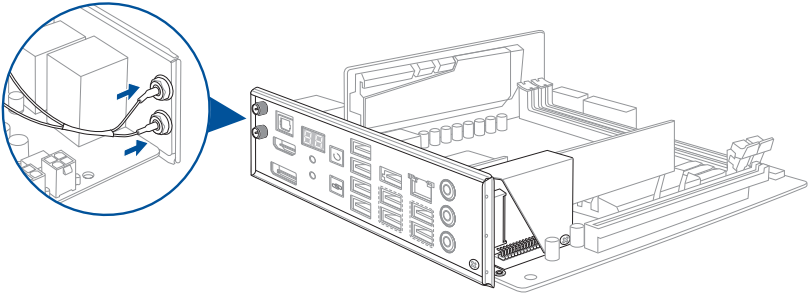

3. Replace the bolt on the connector to secure the antenna connector and the I/O shield in place.

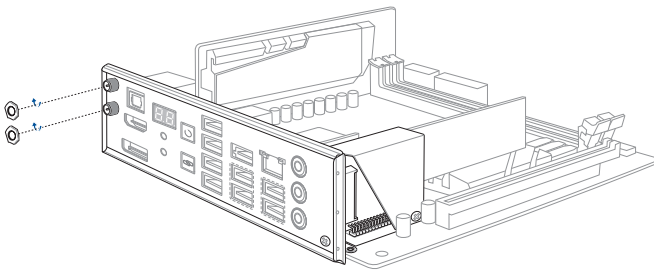

The motherboard layout varies with models.

2.2 BIOS update utility

USB BIOS Flashback

USB BIOS Flashback allows you to easily update the BIOS without entering the existing BIOS or operating system. Simply insert a USB storage device to the USB port, press the ROG Connect button for three seconds, and the BIOS is updated automatically.

To use USB BIOS Flashback:

1. Download the latest BIOS file from the ASUS website
2. Extract and rename the BIOS image file to **M7I.CAP**.
3. Copy **M7I.CAP** to the root directory of the USB flash disk drive.
4. Turn off the system and insert the USB storage device to the ROG Connect port.
5. Press the ROG Connect button and release when a flashing light appears, which indicates that the BIOS Flashback function is enabled.
6. Wait until the light goes out, indicating that the BIOS updating process is completed.

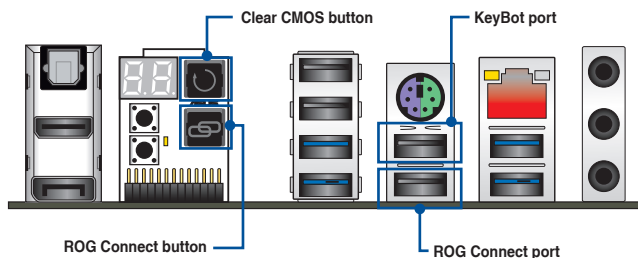

- For more BIOS update utilities in BIOS setup, refer to section **Updating BIOS** in Chapter 3.
- Connect your USB keyboard on the KeyBot port if you want to use the KeyBot feature.



Updating BIOS may have risks. If the BIOS program is damaged during the process and results to the system's failure to boot up, please contact your local ASUS Service Center.

2.3 Motherboard rear and audio connections

2.3.1 Rear I/O connection

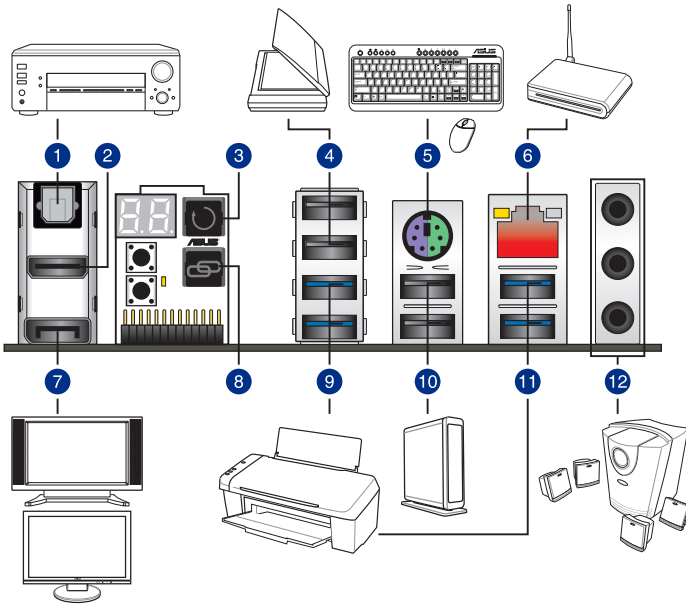

Rear panel connectors

1. Optical S/PDIF OUT port
2. HDMI port
3. Clear CMOS button
4. USB 2.0 ports 7-8
5. PS/2 Keyboard/mouse combo port
6. LAN (RJ-45) port*
7. DisplayPort
8. ROG Connect button
9. USB 3.0 port 3-4
10. USB 2.0 port 9-10 (Upper port is for the dedicated KeyBot port. The lower port supports the USB BIOS Flasback and ROG Connect.)
11. USB 3.0 port 5-6
12. Audio I/O ports**

* and **: Refer to the tables on the next page for LAN port LEDs and audio port definitions.



- Due to USB 3.0 controller limitation, USB 3.0 devices can only be used under Windows OS environment and after the USB 3.0 driver installation.
- USB 3.0 devices can only be used as data storage only.
- We strongly recommend that you connect USB 3.0 devices to USB 3.0 ports for faster and better performance for your USB 3.0 devices.
- Due to the design of the Intel 8 series chipset, all USB devices connected to the USB 2.0 and USB 3.0 ports are controlled by the xHCI controller. Some legacy USB devices must update their firmware for better compatibility.

*** LAN ports LED indications**

Activity Link LED		Speed LED	
Status	Description	Status	Description
OFF	No link	OFF	10 Mbps connection
ORANGE	Linked	ORANGE	100 Mbps connection
BLINKING	Data activity	GREEN	1 Gbps connection

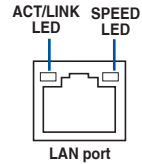

**** Audio 2.1, 4.1, 5.1 or 7.1-channel configuration**

Port	Headset 2.1-channel	4.1-channel	5.1-channel	7.1-channel
LINEIN	Line In	Rear Speaker Out	Rear Speaker Out	Rear Speaker Out
LINEOUT	Line Out	Front Speaker Out	Front Speaker Out	Front Speaker Out
MIC	Mic In	Mic In	Bass/Center	Bass/Center
HEADPHONE (Front panel)	–	–	–	Side Speaker Out



- Jack-retasking supports 4.1, 5.1, and 7.1-channel audio outputs. Launch Realtek HD Audio Manager to configure the jack-retasking setting.
- To support 7.1 channel audio output, ensure that your chassis has an HD audio module on the front panel.

2.3.2 Audio I/O connections

Audio I/O ports

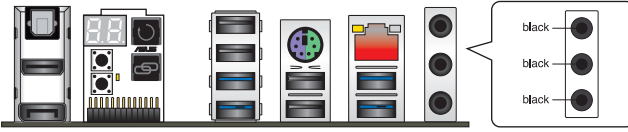

Connect to Headphone and Mic



Connect to Stereo Speakers

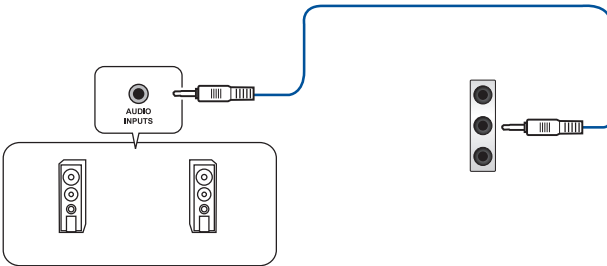

Connect to 2.1 channel Speakers

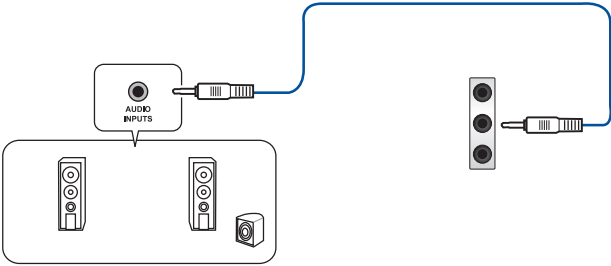

Connect to 4.1 channel Speakers

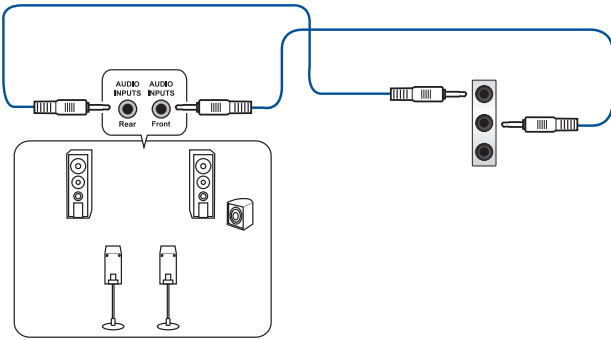

Connect to 5.1 channel Speakers

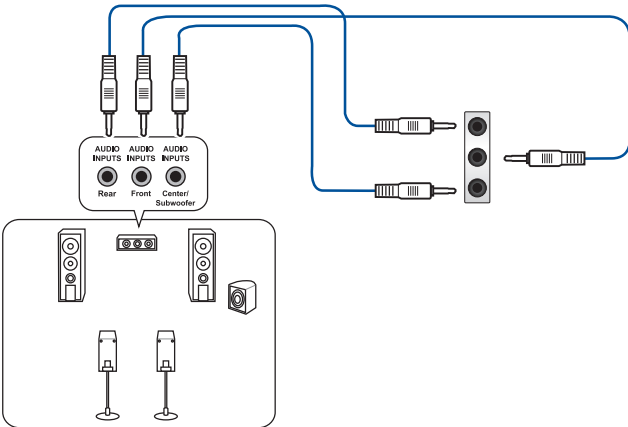

Connect to 7.1 channel Speakers

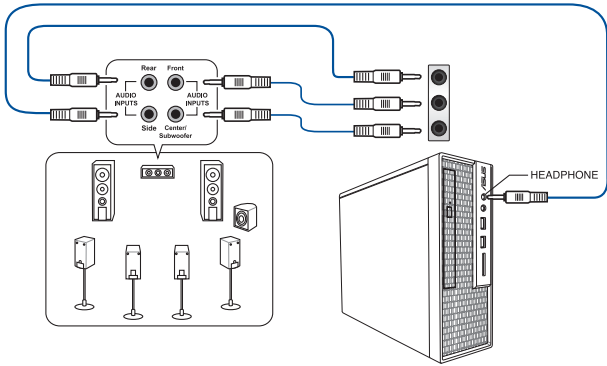

2.4 Starting up for the first time

1. After making all the connections, replace the system case cover.
2. Ensure that all switches are off.
3. Connect the power cord to the power connector at the back of the system chassis.
4. Connect the power cord to a power outlet that is equipped with a surge protector.
5. Turn on the devices in the following order:
 - a. Monitor
 - b. External SCSI devices (starting with the last device on the chain)
 - c. System power
6. After applying power, the system power LED on the system front panel case lights up. For systems with ATX power supplies, the system LED lights up when you press the ATX power button. If your monitor complies with the “green” standards or if it has a “power standby” feature, the monitor LED may light up or change from orange to green after the system LED turns on.

The system then runs the power-on self tests (POST). While the tests are running, the BIOS beeps (refer to the BIOS beep codes table) or additional messages appear on the screen. If you do not see anything within 30 seconds from the time you turned on the power, the system may have failed a power-on test. Check the jumper settings and connections or call your retailer for assistance.

BIOS Beep	Description
One short beep	VGA detected Quick boot set to disabled No keyboard detected
One continuous beep followed by two short beeps then a pause (repeated)	No memory detected
One continuous beep followed by three short beeps	No VGA detected
One continuous beep followed by four short beeps	Hardware component failure

7. At power on, hold down the <Delete> key to enter the BIOS Setup. Follow the instructions in Chapter 3.

2.5 Turning off the computer

While the system is ON, press the power button for less than four seconds to put the system on sleep mode or soft-off mode, depending on the BIOS setting. Press the power switch for more than four seconds to let the system enter the soft-off mode regardless of the BIOS setting.

BIOS setup

3

3.1 Knowing BIOS



The new ASUS UEFI BIOS is a Unified Extensible Interface that complies with UEFI architecture, offering a user-friendly interface that goes beyond the traditional keyboard-only BIOS controls to enable a more flexible and convenient mouse input. You can easily navigate the new UEFI BIOS with the same smoothness as your operating system. The term “BIOS” in this user manual refers to “UEFI BIOS” unless otherwise specified.

BIOS (Basic Input and Output System) stores system hardware settings such as storage device configuration, overclocking settings, advanced power management, and boot device configuration that are needed for system startup in the motherboard CMOS. In normal circumstances, the default BIOS settings apply to most conditions to ensure optimal performance. **DO NOT change the default BIOS settings** except in the following circumstances:

- An error message appears on the screen during the system bootup and requests you to run the BIOS Setup.
- You have installed a new system component that requires further BIOS settings or update.



Inappropriate BIOS settings may result in instability or boot failure. **We strongly recommend that you change the BIOS settings only with the help of a trained service personnel.**



When downloading or updating the BIOS file, rename it as **M7I.CAP** for this motherboard.

3.2 BIOS setup program

Use the BIOS Setup to update the BIOS or configure its parameters. The BIOS screen include navigation keys and brief onscreen help to guide you in using the BIOS Setup program.

Entering BIOS at startup

To enter BIOS Setup at startup, press <Delete> during the Power-On Self Test (POST). If you do not press <Delete>, POST continues with its routines.

Entering BIOS Setup after POST

To enter BIOS Setup after POST:

- Press <Ctrl>+<Alt>+<Delete> simultaneously.
- Press the reset button on the system chassis.
- Press the power button to turn the system off then back on. Do this option only if you failed to enter BIOS Setup using the first two options.

After doing either of the three options, press <Delete> key to enter BIOS.



-
- The BIOS setup screens shown in this section are for reference purposes only, and may not exactly match what you see on your screen.
 - Ensure that a USB mouse is connected to your motherboard if you want to use the mouse to control the BIOS setup program.
 - If the system becomes unstable after changing any BIOS setting, load the default settings to ensure system compatibility and stability. Select the **Load Optimized Defaults** item under the **Exit** menu or press hotkey <F5>. See section 3.10 **Exit menu** for details.
 - If the system fails to boot after changing any BIOS setting, try to clear the CMOS and reset the motherboard to the default value. See section 1.2.6 **Onboard buttons** for information on how to erase the RTC RAM via the Clear CMOS button.
 - The BIOS setup program does not support the Bluetooth devices.
-

BIOS menu screen

The BIOS Setup program can be used under two modes: **EZ Mode** and **Advanced Mode**. You can change modes from the **Exit** menu or from the **Exit/Advanced Mode** screen.

3.2.1 EZ Mode

By default, the EZ Mode screen appears when you enter the BIOS setup program. The EZ Mode provides you an overview of the basic system information, and allows you to select the display language, system performance mode and boot device priority. To access the Advanced Mode, click **Exit/Advanced Mode**, then select **Advanced Mode** or press <F7> hot key for the advanced BIOS settings.



The default screen for entering the BIOS setup program can be changed between EZ Mode or Advanced Mode. Refer to the Setup Mode item in section 3.8 **Boot menu** for details.

The screenshot shows the 'UEFI BIOS Utility - EZ Mode' interface. At the top, it displays the date and time (07/01/2014 10:43), language (English), and EZ Tuning Wizard (F11). The main area is divided into several sections: 'Information' (MAXIMUS VII IMPACT, BIOS Ver. 0213, CPU G3220T @ 2.60GHz, Speed: 2600 MHz, Memory: 2048 MB), 'CPU Temperature' (47°C), 'CPU Voltage' (0.912 V), and 'Motherboard Temperature' (37°C). There are also sections for 'DRAM Status', 'SATA Information', 'Intel Rapid Storage Technology' (On/Off), 'FAN Profile' (CPU FAN 1133 RPM, CHA1-3 FAN N/A), 'EZ System Tuning' (Performance, Energy Saving, Power Saving), and 'Boot Priority' (P2: ST3160812AS, P1: ASUS DVD-E818A6T, UEFI: (FAT) General USB Flash Disk, UEFI: ASUS DVD-E818A6T). At the bottom, there are navigation options: Default(F5), Save & Exit(F10), and Advanced Mode(F7). A 'Manual Fan Tuning' graph is also visible.

Displays the system properties of the selected mode.
Click < or > to switch EZ System Tuning modes

Displays the CPU/motherboard temperature, CPU voltage output, CPU/chassis/power fan speed, and SATA information

Selects the display language of the BIOS setup program

Creates storage RAID and configures system overlocking

Enables or disables the Intel Rapid Storage Technology

Shows the bootable devices

Loads optimized default settings

Displays the Advanced mode menus

Selects the boot device priority

Saves the changes and resets the system

Displays the CPU Fan's speed. Click the button to manually tune the fans



The boot device options vary depending on the devices you installed to the system.

3.2.2 Advanced Mode

The Advanced Mode provides advanced options for experienced end-users to configure the BIOS settings. The figure below shows an example of the Advanced Mode. Refer to the following sections for the detailed configurations.



To switch from EZ Mode to Advanced Mode, click **Advanced Mode** or press F7 hotkey.

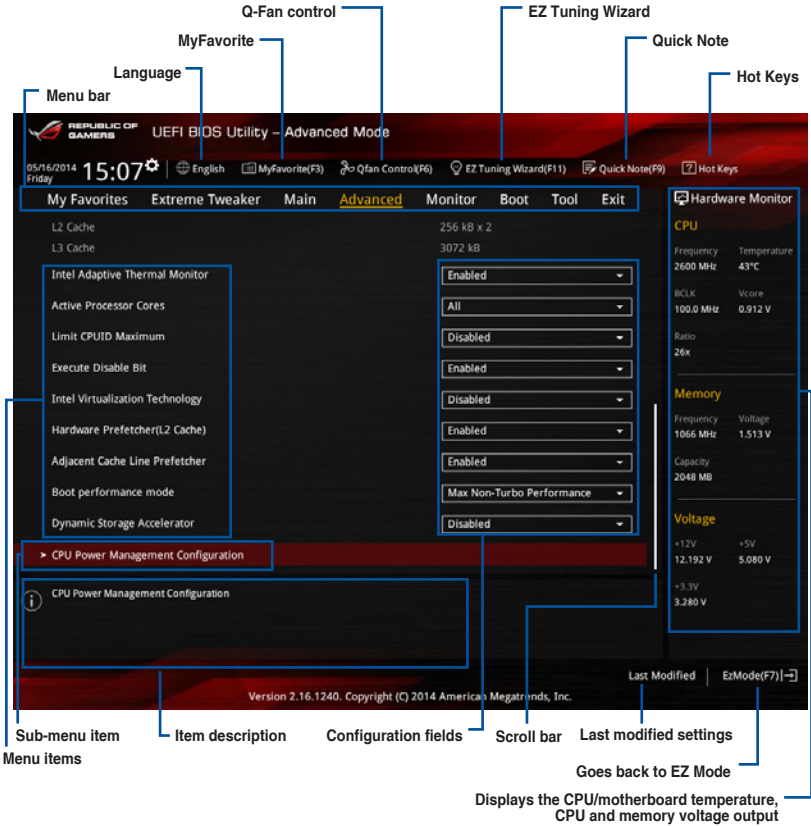

Menu bar

The menu bar on top of the screen has the following main items:

My Favorites	For saving the frequently-used system settings and configuration.
Extreme Tweaker	For changing the overclocking settings
Main	For changing the basic system configuration
Advanced	For changing the advanced system settings
Monitor	For displaying the system temperature, power status, and changing the fan settings.
Boot	For changing the system boot configuration
Tool	For configuring options for special functions
Exit	For selecting the exit options and loading default settings

Menu items

The highlighted item on the menu bar displays the specific items for that menu. For example, selecting **Main** shows the Main menu items.

The other items (My Favorites, Extreme Tweaker, Advanced, Monitor, Boot, Tool, and Exit) on the menu bar have their respective menu items.

Submenu items

A greater than sign (>) before each item on any menu screen means that the item has a submenu. To display the submenu, select the item and press <Enter>.

Language

This button above the menu bar contains the languages that you can select for your BIOS. Click this button to select the the language that you want to display in your BIOS screen.

MyFavorites (F3)

This button above the menu bar shows all BIOS items in a Tree Map setup. Select frequently-used BIOS settings and save it to MyFavorites menu.



Refer to section **3.3 My Favorites** for more information.

Q-Fan Control (F6)

This button above the menu bar displays the current settings of your fans. Use this button to manually tweak the fans to your desired settings.



Refer to section **3.2.3 QFan Control** for more information.

EZ Tuning Wizard (F11)

This button above the menu bar allows you to view and tweak the overclocking settings of your system. It also allows you to change the motherboard's SATA mode from AHCI to RAID mode.



Refer to section **3.2.4 EZ Tuning Wizard** for more information.

Quick Note (F9)

This button above the menu bar allows you to key in notes of the activities that you have done in BIOS.



- The Quick Note function does not support the following keyboard functions: delete, cut, copy and paste.
- You can only use the alphanumeric characters to enter your notes.

Hot keys

This button above the menu bar contains the navigation keys for the BIOS setup program. Use the navigation keys to select items in the menu and change the settings.

Scroll bar

A scroll bar appears on the right side of a menu screen when there are items that do not fit on the screen. Press the Up/Down arrow keys or <Page Up> / <Page Down> keys to display the other items on the screen.

General help

At the top right corner of the menu screen is a brief description of the selected item. Use <F12> key to capture the BIOS screen and save it to the removable storage device.

Configuration fields

These fields show the values for the menu items. If an item is user-configurable, you can change the value of the field opposite the item. You cannot select an item that is not user-configurable.

A configurable field is highlighted when selected. To change the value of a field, select it and press <Enter> to display a list of options.

Last Modified button

This button shows the items that you last modified and saved in BIOS Setup.

3.2.3 QFan Control

The QFan Control allows you to set a fan profile or manually configure the operating speed of your CPU and chassis fans.

Click to select a fan to be configured

Click to activate PWM Mode*

Click to activate DC Mode*

Q-Fan Tuning

Select your target fan and then move the slider to select any of these profiles: Standard, Silent, Turbo and Full Speed. You can also move the slider to Manual and manually configure the fan's operating speed.

CPU FAN
CHA1 FAN
CHA2 FAN
CHA3 FAN

PWM DC

100%
50%
0

0 30 70 100 °C

Standard Silent Turbo Full Speed Manual

Undo Apply Exit (ESC)

Default (F5) | Save & Exit (F10) | Advanced Mode (F7)

Select a profile to apply to your fans

Click to undo the changes

Click to apply the fan setting

Click to go back to main menu

Select to manually configure your fans



Only the CPU fan can be switched between DC mode and PWM mode.

Configuring fans manually

Select **Manual** from the list of profiles to manually configure your fans' operating speed.

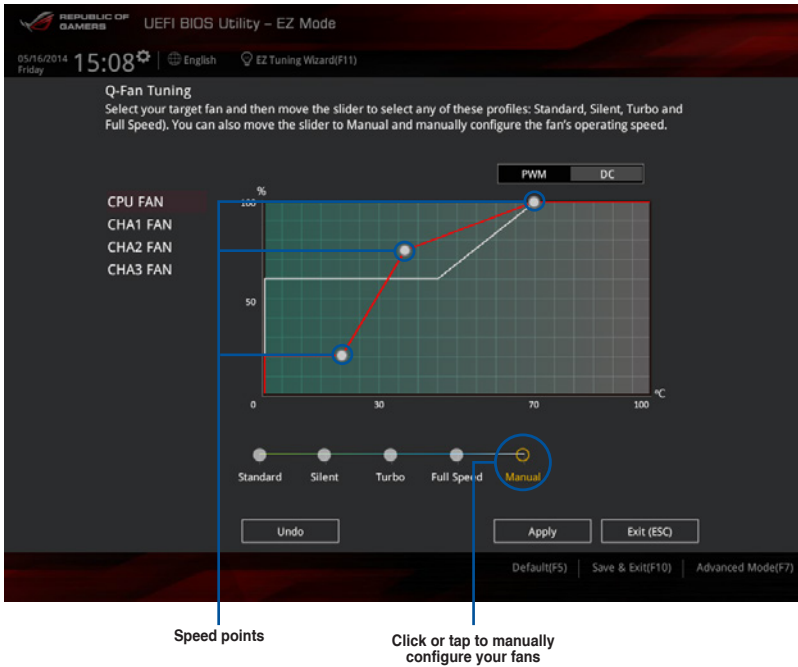

To configure your fans:

1. Select the fan that you want to configure and to view its current status.
2. Click and drag the speed points to adjust the fans' operating speed.
3. Click **Apply** to save the changes then click **Exit (ESC)**.

3.2.4 EZ Tuning Wizard

EZ Tuning Wizard allows you to overclock your CPU and DRAM, computer usage, and CPU fan to their best settings. You can also easily set RAID in your system using this feature.

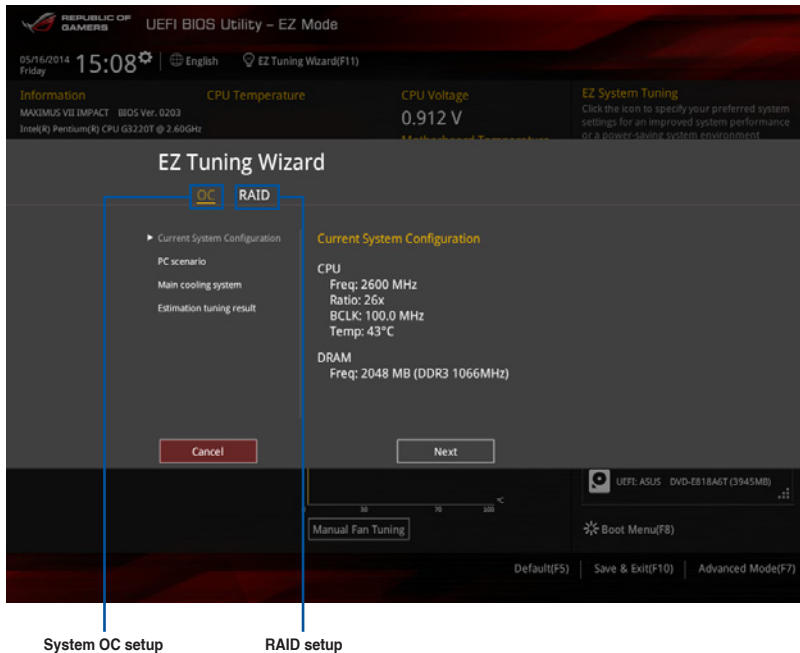

Tuning your system settings

To tune your settings:

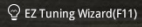
1. Press <F11> on your keyboard or click  from the BIOS screen to open EZ Tuning Wizard screen, then click **Next**.
2. Select a PC scenario **Daily Computing** or **Gaming/Media Editing**, then click **Next**.
3. Select the CPU fan type (**Box cooler**, **Tower cooler**, or **Water cooler**) that you installed then click **Next**.



If you are not sure of the CPU fan type, click **I'm not sure**. The system automatically detects the CPU fan type.

4. Click **Next** then click **Yes** to confirm auto-tuning.

Creating RAID

To create RAID:

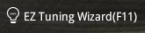
1. Press <F11> on your keyboard or click  from the BIOS screen to open EZ Tuning Wizard screen.
2. Click **RAID** then click **Next**.



- Ensure that your HDDs have no existing RAID volumes.
- Ensure to connect your HDDs to Intel® SATA connectors.

3. Select the type of storage for your RAID **Easy Backup** or **Super Speed**, then click **Next**.

- a. For Easy Backup, click **Next** then select from **Easy Backup (RAID1)** or **Easy Backup (RAID10)**.



You can only select Easy Backup (RAID 10) if you connect four (4) HDDs.



- b. For Easy Backup, click **Next** then select from **Super Speed (RAID0)** or **Super Speed (RAID5)**.

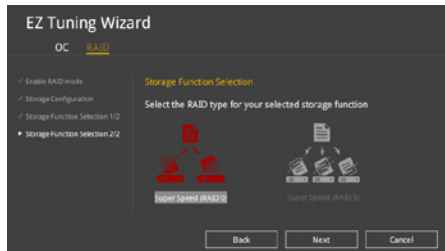

4. After selecting the type of RAID, click **Next** then click **Yes** to continue the RAID setup.
5. After the RAID setup is done, click **Yes** to exit the setup then click **OK** to reset your system.

3.3 My Favorites

My Favorites is your personal space where you can easily save and access your favorite BIOS items.

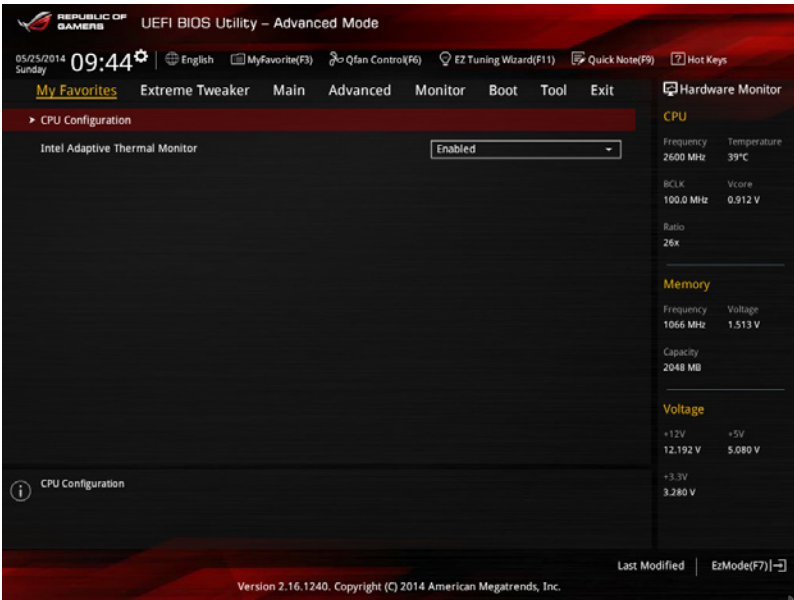

Adding items to My Favorites

To add BIOS items:

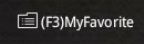
1. Press <F3> on your keyboard or click  from the BIOS screen to open Setup Tree Map screen.
2. On the Setup Tree Map screen, select the BIOS items that you want to save in MyFavorites screen.

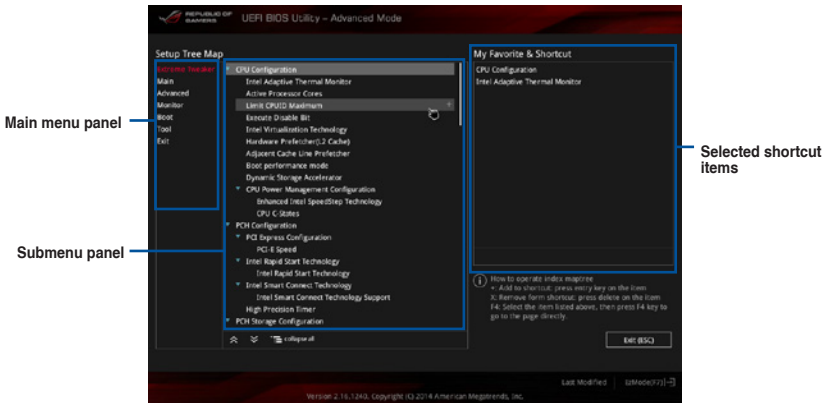

3. Select an item from main menu panel, then click the submenu that you want to save as favorite from the submenu panel and tap or click  or press <Enter> on your keyboard.



You cannot add the following items to My Favorite items:

- Items with submenu options
- User-managed items such as language and boot order
- Configuration items such as Memory SPD Information, system time and date.

4. Click **Exit (ESC)** or press <esc> key to close Setup Tree Map screen.
5. Go to My Favorites menu to view the saved BIOS items.

3.4 Extreme Tweaker menu

The Extreme Tweaker menu items allow you to configure overclocking-related items.



Be cautious when changing the settings of the Extreme Tweaker menu items. Incorrect field values can cause the system to malfunction.



The configuration options for this section vary depending on the CPU and DIMM model you installed on the motherboard.

Scroll down to display other BIOS items.

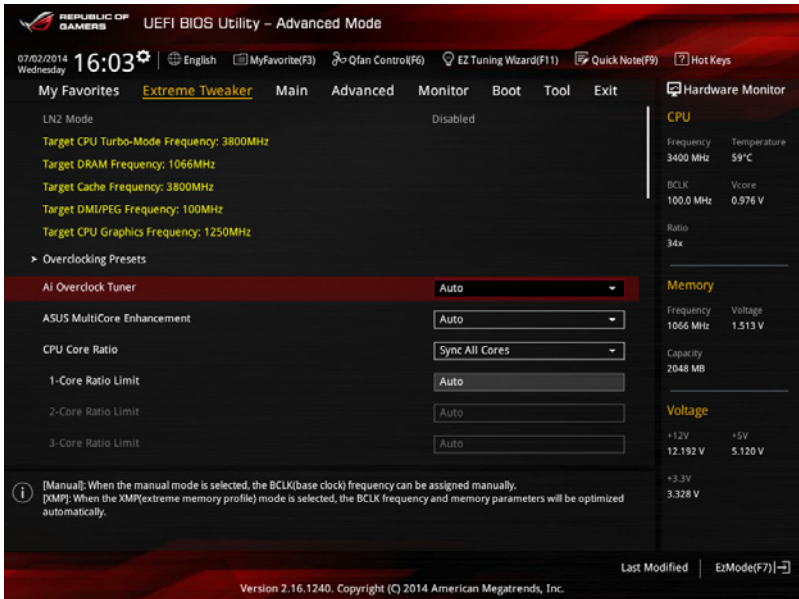

Overclocking Presets [Auto]

This item allows you to load various default overclocking presets. You can select an overclocking preset from these options:

Load Gamer's OC Profile

Configuration options: [OK] [Cancel]

Load 82 BCLK Profile

Configuration options: [OK] [Cancel]

Load 190 BCLK Profile

Configuration options: [OK] [Cancel]

Load 195 BCLK Profile

Configuration options: [OK] [Cancel]

Load 200 BLCK Profile

Configuration options: [OK] [Cancel]

Load 3700 DRAM Freq. with 2x4GB in CHA

Configuration options: [OK] [Cancel]

Load 3800 DRAM Freq. with 2x4GB in CHA

Configuration options: [OK] [Cancel]

Load 3842 DRAM Freq. with 2x4GB in CHA

Configuration options: [OK] [Cancel]

Load 3900 DRAM Freq. with 2x4GB in CHA

Configuration options: [OK] [Cancel]

Load 3930 DRAM Freq. with 2x4GB in CHA

Configuration options: [OK] [Cancel]

Ai Overclock Tuner [Auto]

This item allows you to select the CPU overclocking options to achieve the desired CPU internal frequency. Select any of these preset overclocking configuration options:

[Auto]	Loads the optimal settings for the system.
[Manual]	Allows you to individually set overclocking parameters.
[X.M.P.]	If you install memory modules supporting the eXtreme Memory Profile (X.M.P.) Technology, choose this item to set the profiles supported by your memory modules for optimizing the system performance.



-
- The [X.M.P.] configuration option appears only when you install memory modules supporting the eXtreme Memory Profile (X.M.P.) Technology.
 - The following items appear only when you set the Ai Overclock Tuner to [Manual] or [X.M.P.].
-

CPU Strap [Auto]

This item allows you to select a strap close to your target BCLK (base clock) for an extreme overclocking, or leave it at [Auto] for the BIOS to upgrade.

Configuration options: [Auto] [100MHz] [125MHz] [167MHz] [250MHz]

PLL Selection [Auto]

This item is set to LC PLL by default for better stability. Select **SB PLL** when the BCLK (base clock) frequency is far away from 100 MHz. This may affect the function of other devices that need precise clock jitters.

Configuration options: [Auto] [LC PLL] [SB PLL]

Filter PLL [Auto]

This item allows you to select a BCLK (base clock) mode when using a very high BCLK to improve the overclocking capability.

Configuration options: [Auto] [Low BCLK Mode] [High BCLK Mode]

BCLK Frequency [100.0]

This item allows you to configure a higher BCLK (base clock) frequency to enhance the system performance. Use the <+> or <-> to adjust the value. The values range from 80.0MHz - 300.0MHz.



We recommend you to set the value based on the CPU specification. High BCLK frequencies may damage the CPU permanently.



When Ai Overclock Tuner is set to [XMP], the XMP mode supported by the installed memory module is displayed.

ASUS MultiCore Enhancement [Auto]

[Auto] This item allows you to maximize the overclocking performance optimized by ASUS core ratio settings.

[Disabled] This item allows you to set to default core ratio settings.

CPU Core Ratio [Sync All Cores]

This item allows you to set the CPU core ratio limit per core or synchronize automatically to all cores.

Configuration options: [Auto] [Sync All Cores] [Per Core]



When the CPU Core Ratio is set to [Sync All Cores], the following item appears.

1-Core Ratio Limit [Auto]

Select [Auto] to apply the CPU default Turbo Ratio setting or manually assign a 1-Core Limit value that must be higher than or equal to the 2-Core Ratio Limit.



When the CPU Core Ratio is set to [Per Core], the following item appears:

1-Core Ratio Limit [Auto]

Select [Auto] to apply the CPU default Turbo Ratio setting or manually assign a 1-Core Limit value that must be higher than or equal to the 2-Core Ratio Limit.

2-Core Ratio Limit [Auto]

Select [Auto] to apply the CPU default Turbo Ratio setting or manually assign a 2-Core Limit value that must be higher than or equal to the 3-Core Ratio Limit.



If you assign a value for 2-Core Ratio Limit, do not set the 1-Core Ratio Limit to [Auto].

3-Core Ratio Limit [Auto]

Select [Auto] to apply the CPU default Turbo Ratio setting or manually assign a 3-Core Limit value that must be higher than or equal to the 4-Core Ratio Limit.



If you assign a value for 3-Core Ratio Limit, do not set the 1-Core Ratio Limit and 2-Core Ratio Limit to [Auto].

4-Core Ratio Limit [Auto]

Select [Auto] to apply the CPU default Turbo Ratio setting or manually assign a 4-Core Limit value that must be higher than or equal to the 3-Core Ratio Limit.



If you assign a value for 4-Core Ratio Limit, do not set the 1-Core Ratio Limit, 2-Core Ratio Limit, and 3-Core Ratio to [Auto].

Min. CPU Cache Ratio [Auto]

This item allows you to set the minimum possible ratio on the Uncore part of the processor. Use the <+> or <-> keys to adjust the value. The values depend on the CPU installed.

Max. CPU Cache Ratio [Auto]

This item allows you to set the maximum possible ratio on the Uncore part of the processor. Use the <+> or <-> keys to adjust the value. The values depend on the CPU installed.

Internal PLL Overvoltage [Auto]

This item allows you to enable the internal PLL voltage for K-SKU CPUs to get the extreme overclocking capability.

Configuration options: [Auto] [Enabled] [Disabled]

BCLK Frequency: DRAM Frequency Ratio [Auto]

This item allows you to set the base clock frequency of the DRAM frequency ratio.

[Auto] The DRAM ratio is set to its optimized settings.

[100:100] The DRAM ratio is set to 100:100.

[100:133] The DRAM ratio is set to 100:133.

DRAM Frequency [Auto]

Allows you to set the memory operating frequency. The configuration options vary with the BCLK Frequency Ratio item settings.

Xtreme Tweaking [Disabled]

This item helps improve some benchmarks performance.

Configuration options: [Enabled] [Disabled]

CPU Level Up [Auto]

This item allows you to select a CPU level. The related parameters automatically adjusts according to the selected CPU level.



The CPU level values depends on the CPU installed in your system.

EPU Power Saving Mode [Disabled]

This item allows you to set the CPU in its minimum power consumption settings. Enable this item to set lower CPU VCCIN and VCore voltages and achieve the best energy saving condition.

Configuration options: [Disabled] [Enabled]

DRAM Timing Control

The subitems in this menu allow you to set the DRAM timing control features. Use the <+> and <-> keys to adjust the value. To restore the default setting, type [auto] using the keyboard and press the <Enter> key.

Memory Presets

The items in this sub-menu allow you to select a preset memory setting for different memory modules.

Load 2x2GB Elpida Hyper 1.8V 2133

Configuration options: [Yes] [No]

Load 2x2GB PSC 1.65V 2400

Configuration options: [Yes] [No]

Load 2x2GB 1T PSC 1.85V 2400

Configuration options: [Yes] [No]

Load 2x2GB PSC 1.85V 2600

Configuration options: [Yes] [No]

Load 2x2GB LN2 PSC 1.85V 2600

Configuration options: [Yes] [No]

Load 2x2GB BBSE 1.65V 2200

Configuration options: [Yes] [No]

Load 2x2GB BBSE 1.85V 2400

Configuration options: [Yes] [No]

Load 2x2GB LN2 BBSE 2.0V 2600

Configuration options: [Yes] [No]

Load 2x4GB Samsung 1.65V 2666

Configuration options: [Yes] [No]

Load 2x4GB Samsung 1.85V 2666

Configuration options: [Yes] [No]

Load 2x4GB Samsung 1.85V 2666

Configuration options: [Yes] [No]

Load 2x4GB Samsung 1.85V 2800

Configuration options: [Yes] [No]

Load 2x4GB Hynix 1.65V 2600

Configuration options: [Yes] [No]

Load 2x4GB Hynix 1.85V 2600

Configuration options: [Yes] [No]

Load 2x4GB Hynix 1.85V 2750

Configuration options: [Yes] [No]

Load 2x4GB LN2 Hynix 2.0V 2800

Configuration options: [Yes] [No]

Load 2x4GB Hynix Single-sided 1.65V 2400

Configuration options: [Yes] [No]

Load 2x4GB Hynix Single-sided 1.85V 2400

Configuration options: [Yes] [No]

Load 2x4GB New Single-sided 1.85V 3000

Configuration options: [Yes] [No]

Load 2x8GB Samsung 1.65V 2400

Configuration options: [Yes] [No]

Load 2x8GB Samsung 1.80V 2600

Configuration options: [Yes] [No]

Load 2x8GB Hynix 1.85V 2600

Configuration options: [Yes] [No]

Load 2x8GB New Hynix 1.85V 2933

Configuration options: [Yes] [No]

Load 2x4GB Hynix MRF 1.75V 2933

Configuration options: [Yes] [No]

Load 2x4GB Hynix MRF 1.75V 3100

Configuration options: [Yes] [No]

Load 2GB RAW MHz

Configuration options: [Yes] [No]

Load 4GB/8GB RAW MHz

Configuration options: [Yes] [No]

Maximus Tweak [Auto]

[Auto] Allows the system to set the memory compatibility, overclocking, and system performance.

[Mode 1] Helps memory compatibility in your system.

[Mode 2] Helps overclocking and stabilizes system performance.

Primary Timings

DRAM CAS# Latency [Auto]

Configuration options: [Auto] [1] – [31]

DRAM RAS# to CAS# Delay [Auto]

Configuration options: [Auto] [1] – [31]

DRAM RAS# PRE Time [Auto]

Configuration options: [Auto] [1] – [31]

DRAM RAS# ACT Time [Auto]

Configuration options: [Auto] [1] – [63]

DRAM COMMAND Rate [Auto]

Configuration options: [Auto] [1] – [2]

Latency Boundary A [Auto]

Configuration options: [Auto] [1] – [28]

Latency Boundary B [Auto]

Configuration options: [Auto] [1] – [14]

Latency Compensator [Auto]

Set this item to [Enabled] to improve performance and overclocking.

Configuration options: [Auto] [Enabled] [Disabled]

Secondary Timings**DRAM RAS# to RAS# Delay [Auto]**

Configuration options: [Auto] [1] – [15]

DRAM REF Cycle Time [Auto]

Configuration options: [Auto] [1] – [511]

DRAM Refresh Interval [Auto]

Configuration options: [Auto] [1] – [65535]

DRAM WRITE Recovery Time [Auto]

Configuration options: [Auto] [1] – [16]

DRAM READ to PRE Time [Auto]

Configuration options: [Auto] [1] – [15]

DRAM FOUR ACT WIN Time [Auto]

Configuration options: [Auto] [1] – [255]

DRAM WRITE to READ Delay [Auto]

Configuration options: [Auto] [1] – [15]

DRAM CKE Minimum Pulse Width [Auto]

Configuration options: [Auto] [1] – [15]

DRAM CAS# Write Latency [Auto]

Configuration options: [Auto] [1] – [31]

RTL IOL control**DRAM RTL Initial Value [Auto]**

Configuration options: [Auto] [1] - [63]

DRAM RTL (CHA_R0D0) [Auto]

Configuration options: [Auto] [1] - [63]

DRAM RTL (CHA_R0D1) [Auto]

Configuration options: [Auto] [1] - [63]

DRAM RTL (CHA_R1D0) [Auto]

Configuration options: [Auto] [1] - [63]

DRAM RTL (CHA_R1D1) [Auto]

Configuration options: [Auto] [1] - [63]

DRAM RTL (CHB_R0D0) [Auto]

Configuration options: [Auto] [1] - [63]

DRAM RTL (CHB_R0D1) [Auto]

Configuration options: [Auto] [1] - [63]

DRAM RTL (CHB_R1D0) [Auto]
Configuration options: [Auto] [1] - [63]

DRAM RTL (CHB_R1D1) [Auto]
Configuration options: [Auto] [1] - [63]

DRAM IO-L (CHA_R0D0) [Auto]
Configuration options: [Auto] [1] - [15]

DRAM IO-L (CHA_R0D1) [Auto]
Configuration options: [Auto] [1] - [15]

DRAM IO-L (CHA_R1D0) [Auto]
Configuration options: [Auto] [1] - [15]

DRAM IO-L (CHA_R1D1) [Auto]
Configuration options: [Auto] [1] - [15]

DRAM IO-L (CHB_R0D0) [Auto]
Configuration options: [Auto] [1] - [15]

DRAM IO-L (CHB_R0D1) [Auto]
Configuration options: [Auto] [1] - [15]

DRAM IO-L (CHB_R1D0) [Auto]
Configuration options: [Auto] [1] - [15]

DRAM IO-L (CHB_R1D1) [Auto]
Configuration options: [Auto] [1] - [15]

Third Timings

tRDRD [Auto]

Configuration options: [Auto] [1] - [7]

tRDRD_dr [Auto]

Configuration options: [Auto] [1] - [15]

tRDRD_dd [Auto]

Configuration options: [Auto] [1] - [15]

tWRRD [Auto]

Configuration options: [Auto] [1] - [63]

tWRRD_dr [Auto]

Configuration options: [Auto] [1] - [15]

tWRRD_dd [Auto]

Configuration options: [Auto] [1] - [15]

tWRWR [Auto]

Configuration options: [Auto] [1] - [7]

tWRWR_dr [Auto]

Configuration options: [Auto] [1] - [15]

tWRWR_dd [Auto]

Configuration options: [Auto] [1] - [15]

Dec_WRD

Configuration options: [Auto] [0] – [1]

tRDWR [Auto]

Configuration options: [Auto] [1] – [31]

tRDWR_dr [Auto]

Configuration options: [Auto] [1] – [31]

tRDWR_dd [Auto]

Configuration options: [Auto] [1] – [31]

MISC

Eventual DRAM Voltage [Auto]

This item allows you to set the DRAM voltage to be reapplied before entering OS. Use the <+> or <-> keys to adjust the value. The values depend on the CPU installed.

MRC Fast Boot [Auto]

This item allows you to enable, disable, or automatically set the MRC fast boot.

Configuration options: [Auto] [Enabled] [Disabled]

DRAM CLK Period [Auto]

This item allows you to select the DRAM clock period.

Configuration options: [Auto] [1] – [14]

Channel A DIMM Control [Enable Bot...]

This item allows you to enable or disable the Channel A DIMM slots.

Configuration options: [Enable Both DIMMS] [Disable DIMM0] [Disable DIMM1] [Disable Both DIMMS]

Channel B DIMM Control [Enable Bot...]

Allows you to enable or disable the Channel B DIMM slots.

Configuration options: [Enable Both DIMMS] [Disable DIMM0] [Disable DIMM1] [Disable Both DIMMS]

Scrambler Setting [Optimized ASUS]

Set this item to [Optimized (ASUS)] to enhance system stability.

Configuration options: [Optimized (ASUS)] [Default (MRC)]

MCH Full Check [Auto]

Set this item to [Enabled] to enhance the system stability. Set to [Disabled] to enhance the DRAM overclocking capability.

Configuration options: [Auto] [Enabled] [Disabled]

DQ Sense Amplifier [Auto]

Reducing the value helps in overclocking and over-voltage.

Configuration options: [Auto] [+8] – [-29]

DQS Sense Amplifier [Auto]

Reducing the value helps in overclocking and over-voltage.

Configuration options: [Auto] [+8] – [-29]

CMD Sense Amplifier [Auto]

Reducing the value helps in overclocking and over-voltage.

Configuration options: [Auto] [+8] – [-29]

DRAM Swizzling Bit 0-4 [Auto]

Set these items to [Enabled] to enhance overclocking capability.

Configuration options: [Auto] [Enabled] [Disabled]

RAW MHz Aid [Auto]

Set this item to [Enabled] to help overclocking but compromises the system performance.

Configuration options: [Auto] [Enabled] [Disabled]

IC Optimizer [Auto]

Set this item to [Enabled] to help overclocking when using a particular IC memory modules.

Configuration options: [Auto] [4GB Samsung] [4GB New Hynix] [4GB Old Hynix] [Samsung 1T] [PSC 1T]

DRAM Additional Training [Auto]

Set this item to [Enabled] to enhance the DRAM overclocking capability.

Configuration options: [Auto] [Disabled] [Enabled]

Skew Control

The items in this sub-menu allow you to achieve better DRAM overclocking capability and stability.

Transmitter Rising Slope [Auto]

Configuration options: [Auto] [0] - [31]

Transmitter Falling Slope [Auto]

Configuration options: [Auto] [0] - [31]

Transmitter Control Time [Auto]

Configuration options: [Auto] [0] - [31]

Receiver Rising Slope [Auto]

Configuration options: [Auto] [0] - [31]

Receiver Falling Slope [Auto]

Configuration options: [Auto] [0] - [31]

Receiver Control Time [Auto]

Configuration options: [Auto] [0] - [31]

ODT RTT WR (CHA) [Auto]

ODT RTT NOM (CHA) [Auto]

ODT RTT WR (CHB) [Auto]

ODT RTT NOM (CHB) [Auto]

GPU.DIMM Post

The GPU.DIMM Post automatically detects and displays the information about the devices or memory installed on the PCIe and DIMM slots. The field shows N/A if there are no devices installed on the slots.

External DIGI+ Power Control

CPU Load-Line Calibration [Auto]

Load-line is defined by Intel® VRM specification and affects CPU power voltage. The CPU working voltage will decrease proportionally to CPU loading. Higher load-line calibration could get higher voltage and good overclocking performance but increases the CPU and VRM thermal conditions.

Select from Level 1 to Level 9 to adjust CPU power voltage from 0% to 100%.



The actual performance boost may vary depending on your CPU specification.



DO NOT remove the thermal module. The thermal conditions must be monitored.

CPU VRM Switching Frequency [Auto]

This item affects the VRM transient response speed and the component thermal production. Select **[Manual]** to configure a higher frequency for a quicker transient response speed.

Configuration options: [Auto] [Manual]



DO NOT remove the thermal module. The thermal conditions should be monitored.



The following item appears only when you set the CPU VRM Switching Frequency to **[Manual]**.

Fixed CPU VRM Switching Frequency (KHz) [300]

This item allows you to set a higher frequency for a quicker transient response speed. Use the <+> or <-> to adjust the value. The values range from 300 KHz to 500 KHz with an interval of 50 KHz.



Do not remove the thermal module when the manual mode is selected. The thermal conditions should be monitored.



The following item appears only when the CPU VRM Switching Frequency is set to **[Auto]**.

VRM Spread Spectrum [Disabled]

This item allows to enhance the system stability.

Configuration options: [Disabled] [Enabled]

CPU Power Phase Control [Auto]

This item allows you to set the power phase control of the CPU.

Configuration options: [Auto] [Standard] [Optimized] [Extreme] [Manual Adjustment]

[Auto]	Set the phase control on its default setting.
[Standard]	Set the phase control based on the CPU command.
[Optimized]	Set the ASUS optimized phase tuning profile.
[Extreme]	Set the full phase mode
[Power Phase Response]	Set manually to a faster phase response to increase system performance or to slower phase response to increase DRAM power efficiency.



DO NOT remove the thermal module when setting this item to **[Extreme]** and **[Manual Adjustment]**. The thermal conditions should be monitored.



- The item **VRM Spread Spectrum** disappears when you set the CPU Power Phase Control to **[Extreme]**.
 - The following item appears only when you set the CPU Power Phase Control to **[Power Phase Response]**.
-

Power Phase Response [Fast]

This item allows you to set a response for the CPU power phase response. The reaction time will take longer when the regular mode is selected.

Configuration options: [Ultra Fast] [Fast] [Medium] [Regular]

CPU Power Duty Control [T.Probe]

CPU Power Duty Control adjusts the current of every VRM phase and the thermal conditions of every phase component.

[T. Probe]	Select to maintain the VRM thermal balance.
[Extreme]	Select to maintain the current VRM balance.



DO NOT remove the thermal module. The thermal conditions should be monitored.

CPU Current Capability [Auto]

DIGI + VRM CPU Current Capability provides wider total power range for overclocking. A higher value setting gets higher VRM power consumption delivery and extends the overclocking frequency range simultaneously.

Configuration options: [Auto] [100%] [110%] [120%] [130%] [140%]



Choose a higher value when overclocking or under a high CPU loading for extra power support.

CPU Power Thermal Control [130]

A higher temperature brings a wider CPU power thermal range and extends the overclocking tolerance to enlarge the O.C. potential. Use the <+> and <-> keys to adjust the value. The values range from 120 to 141.



DO NOT remove the thermal module. The thermal conditions should be monitored.

CPU Input Boot Voltage [Auto]

Set a VCCIN for the CPU right at boot. Use the <+> and <-> keys to adjust the value. The values range from 0.80V to 2.440 with a 0.010V interval.

DRAM Current Capability [100%]

This item allows you to adjust the total power range for DRAM overclocking. A higher value provides a wider total power range and extends the overclocking frequency change simultaneously.

Configuration options: [100%] [110%] [120%] [130%]

DRAM Switching Frequency [Auto]

This item affects the overclocking range and system stability. Configure to a higher frequency to increase the overclocking range or a lower frequency to enhance the system stability.

Configuration options: [Auto] [Manual]



DO NOT remove the thermal module. The thermal conditions should be monitored.

Tweakers' Paradise

The subitems in this menu allow you to set the CPU ratio and features.

BCLK Tuning

VCCIN Shadow Voltage [Auto]

This item allows you to set a pseudo voltage for VCCIN. Use the <+> or <-> key to adjust the value. The values range from 0.800V to 2.440V at 0.010V increment.

Termination Anti-Aliasing [Auto]

Set this item to [Enabled] to smooth out the change of the PLL Termination Voltage, which helps yield a better overclocking result.

Configuration options: [Auto] [Disabled] [Enabled]

Initial PLL Termination Voltage [Auto]

Initial Voltage at which CPU BCLKs are terminated. Maintaining a level close to CPU Input Voltage helps base clock overclocking. Use the <+> or <-> key to adjust the value. The values range from 0.00V to 3.00V at 0.00625V increment.

PLL Termination Reset Voltage [Auto]

Set a phase-locked loop termination reset voltage. Use the <+> or <-> key to adjust the value. The values range from 0.00V to 3.00V at 0.00625V increment.

Eventual PLL Termination Voltage [Auto]

Set an eventual phase-locked loop termination voltage. Use the <+> or <-> key to adjust the value. The values range from 0.00V to 3.00V at 0.00625V increment.

PCH ICC Voltage [Auto]

Power Supply for the Integrated Clock Controller. Lower may be better.

Clock Crossing VBoot [Auto]

This item allows you to increase the value of the clock crossing voltage boot when the rising edge of BCLK DN is equal to the falling edge of the BCLK DP. Use the <+> or <-> key to adjust the value. The values range from 0.1V to 1.9V at 0.00625V increment.

Clock Crossing Reset Voltage [Auto]

This item allows you to increase the value of the clock crossing reset voltage when the rising edge of BCLK DN is equal to the falling edge of the BCLK DP. Use the <+> or <-> key to adjust the value. The values range from 0.1V to 1.9V at 0.00625V increment.

Configuration options: [Auto] [0.1000] - [1.9000]

Clock Crossing Voltage [Auto]

This item allows you to increase the value of the clock crossing voltage when the rising edge of BCLK DN is equal to the falling edge of the BCLK DP. Use the <+> or <-> key to adjust the value. The values range from 0.1V to 1.9V at 0.00625V increment.

Internal CPU Power Management

The subitems in this menu allow you to set the CPU ratio and features.

Enhanced Intel SpeedStep Technology [Enabled]

This item allows the operating system to dynamically adjust the processor voltage and cores frequency which decreases the average power consumption the average heat production.

Configuration options: [Enabled] [Disabled]

Turbo Mode [Enabled]

This item allows you to enable your core processor's speed to run faster than the base operating frequency when it is below operating power, current and temperature specification limit.

Configuration options: [Disabled] [Enabled]



The following items appear only when you set the Turbo Mode to **[Enabled]**.

Turbo Mode Parameters

Long Duration Package Power Limit [Auto]

This item allows you to limit the Turbo Ratio's time duration that exceeds the TDP (Thermal Design Power) for maximum performance. Use the <+> and <-> keys to adjust the value. The values range from 1W to 4096W.

Package Power Time Window [Auto]

Also known as Power Limit 1, this item allows you to maintain the time window for Turbo Ratio over TDP (Thermal Design Power). Use the <+> and <-> keys to adjust the value. The values range from 1 second to 127 seconds.

Short Duration Package Power Limit [Auto]

Also known as Power Limit 2, this item allows you to provide rapid protection when the package power exceeds the Power Limit 1. Use the <+> and <-> keys to adjust the value. The values range from 1W to 4096W.



CPU Integrated VR Current Limit appears when you set the Turbo Mode to [Enabled] or [Disabled].

CPU Integrated VR Current Limit [Auto]

This item allows you to set a higher current limit to prevent frequency and power throttling when overclocking. Use the <+> and <-> keys to adjust the value. The values range from 0.125 to 1023.875 with a 0.125 interval.

CPU Internal Power Switching Frequency

Frequency Tuning Mode [Auto]

This item allows you to increase or decrease the switching frequency of the internal regulator. Decrease to help consume less power or increase to help voltage stability. When this item is set to [+] or [-], the Frequency Tuning Offset appears and allows you to set its value from 0% to 6%.

CPU Internal Power Fault Control

Thermal Feedback [Auto]

This item allows the CPU to take precautionary actions when the thermal conditions of the external regulator exceeds the threshold.

Configuration options: [Auto] [Disabled] [Enabled]

CPU Integrated VR Fault Management [Auto]

This item allows you to prevent tripping the Fully Integrated Voltage Regulator when doing over-voltage. Configuration options: [Auto] [Disabled] [Enabled]



We recommend to set this item to [Disabled] when overclocking.

CPU Internal Power Configuration

CPU Integrated VR Efficiency Management [Auto]

This item allows you to improve power saving when the processor is in low power state. Disable this item to make the Fully Integrated Voltage Regulator work in high performance at all times.

Configuration options: [Auto] [High Performance] [Balanced]

Power Decay Mode [Auto]

Enable this item to improve the power saving of the Fully Integrated Voltage Regulator as the processor goes into low current state.

Configuration options: [Auto] [Disabled] [Enabled]

Idle Power-in Response [Auto]

This item allows you to set the slew rate for the Fully Integrated Voltage Regulator when it enters manual override mode.

Configuration options: [Auto] [Regular] [Fast]

Idle Power-out Response [Auto]

This item allows you to set the slew rate for the Fully Integrated Voltage Regulator when it exits manual override mode.

Configuration options: [Auto] [Regular] [Fast]

Power Current Slope [Auto]

This item allows you to set a higher power current slope to enhance the power saving condition. Set this item to a lower power current slope level to enhance the system overlocking capability.

Configuration options: [Auto] [LEVEL -4] - [LEVEL 4]

Power Current Offset [Auto]

This item allows you to select higher power current offset percentages to enhance the power saving condition. Select lower power current offset percentages to enhance the system overlocking capability.

Configuration options: [Auto] [100%] [87.5%] [75.0%] [62.5%] [50.0%] [37.5%] [25.0%] [12.5%] [0%] [-12.5%] [-25.0%] [-37.5%] [-50.0%] [-62.5%] [-75.0%] [-87.5%] [-100%]

Power Fast Ramp Response [Auto]

This item allows you to increase to enhance the response of the voltage regulator during the load transient.

Configuration options: [Auto] [0.00] - [1.50]

CPU Internal Power Saving Control

Power Saving Level 1 Threshold [Auto]

Lower value provides sufficient overlocking tolerance to enlarge the overlocking potential. Higher value provides better power-saving condition. Use the <+> or <-> key to adjust the value. The values range from 0A to 80A at 1Amp increment.

Power Saving Level 2 Threshold [Auto]

Lower value provides sufficient overlocking tolerance to enlarge the overlocking potential. Higher value provides better power-saving condition. Use the <+> or <-> key to adjust the value. The values range from 0A to 50A at 1Amp increment.

Power Saving Level 3 Threshold [Auto]

Lower value provides sufficient overlocking tolerance to enlarge the overlocking potential. Higher value provides better power-saving condition. Use the <+> or <-> key to adjust the value. The values range from 0A to 30A at 1Amp increment.

Fully Manual Mode [Enabled]

Set this item to [Enabled] to support voltage control via ROG Connect and OC Panel.

Configuration options: [Disabled] [Enabled]



The following items appear only when you set Fully Manual Mode item to **[Enabled]**.

CPU Graphics Voltage [Auto]

This item allows you to configure the amount of voltage fed to the CPU graphics. Increase the voltage when configuring a high CPU graphics frequency. Use the <+> or <-> key to adjust the value. The values range from 0.8V to 1.920V at 0.01V increment.

CPU System Agent Voltage [Auto]

This item allows you to configure the amount of voltage fed to the system agent of the CPU including the PCI-E controller and the PCU (power control unit). Configure a high system agent voltage to enhance the overclocking capability. Use the <+> or <-> key to adjust the value. The values range from 0.85V to 2.20V at 0.003125V increment.

CPU Analog I/O Voltage [Auto]

This item allows you to configure the amount of voltage fed to the analog portion of the I/O on the CPU. Configure a high analog I/O voltage to enhance the overclocking capability. Use the <+> or <-> key to adjust the value. The values range from 1.0V to 2.20V at 0.003125V increment.

CPU Digital I/O Voltage [Auto]

This item allows you to configure the amount of voltage fed to the digital portion of the I/O on the CPU. Configure a high digital I/O voltage to enhance the overclocking capability. Use the <+> or <-> key to adjust the value. The values range from 1.0V to 2.20V at 0.003125V increment.



The following items appear only when you set the Fully Manual Mode item to **[Disabled]**.

CPU Core Voltage [Auto]

This item allows you to configure the amount of Voltage fed to the CPU cores. Increase the voltage when configuring a high CPU core frequency.

Configuration options: [Auto] [Manual Mode] [Offset Mode] [Adaptive Mode]



The following item appears only when you set the CPU Core Voltage to **[Manual Mode]**.

CPU Core Voltage Override [Auto]

This item allows you to configure the CPU core voltage. Use<+> or <-> key to adjust the value. The values range from 0.001V to 1.920V at 0.001V increment.



The following items appear only when you set the CPU Core Voltage to **[Offset Mode]**.

Offset Mode Sign [+]

[+] To offset the voltage by a positive value.

[-] To offset the voltage by a negative value.

CPU Core Voltage Offset [Auto]

This item allows you to configure the CPU core voltage offset value.

Use <+> or <-> key to adjust the value. The values range from 0.001V to 0.999V at 0.001V increment.



The following items appear only when you set the CPU Core Voltage to **[Adaptive Mode]**.

Additional Turbo Mode CPU Core Voltage [Auto]

This item allows you to set the amount of voltage fed to the CPU cores when running in turbo mode. Increase the voltage when configuring a high CPU core frequency. The voltage you set is affected by the offset value.

Use the <+> or <-> keys to adjust the value. The values range from 0.001V to 1.920 V with a 0.001 V interval.

Total Adaptive Mode CPU Core Voltage [Auto]

This item sums up the voltages of the CPU Core Voltage offset and Additional Turbo Mode CPU Core Voltage options.

CPU Cache Voltage [Auto]

This item allows you to configure the amount of voltage fed to the CPU uncores including it is cache. Increase the voltage when configuring a high CPU cache frequency.

Configuration options: [Auto] [Manual Mode] [Offset Mode] [Adaptive Mode]



The following item appears only when you set the CPU Cache Voltage to **[Manual Mode]**.

CPU Cache Voltage Override [Auto]

This item allows you to configure the CPU cache voltage. Use <+> or <-> key to adjust the value. The values range from 0.001V to 1.920V at 0.001V increment.



The following items appear only when you set the CPU Core Voltage to **[Offset Mode]**.

Offset Mode Sign [+]

[+] To offset the voltage by a positive value.

[-] To offset the voltage by a negative value.

CPU Cache Voltage Offset [Auto]

This item allows you to configure the CPU cache voltage offset value.

Use <+> or <-> key to adjust the value. The values range from 0.001V to 0.999V at 0.001V increment.



The following items appear only when you set the CPU Core Voltage to **[Adaptive Mode]**.

Additional Turbo Mode CPU Cache Voltage [Auto]

This item allows you to set the amount of voltage fed to the CPU cores when running in turbo mode. Increase the voltage when configuring a high CPU core frequency. The voltage you set is affected by the offset value. Use the <+> or <-> keys to adjust the value. The values range from 0.001V to 1.920 V with a 0.001 V interval.

Total Adaptive Mode CPU Cache Voltage [Auto]

This item sums up the voltages of the CPU Cache Voltage offset and Additional Turbo Mode CPU Cache Voltage options.

CPU System Agent Voltage Offset Mode Sign [+]

- [+] To offset the voltage by a positive value.
- [-] To offset the voltage by a negative value.

CPU System Agent Voltage Offset [Auto]

This item allows you to set the amount of voltage fed to the system agent of the processor including its PCIE controller and power control unit (PCU). Setting a high system agent voltage may enhance the overclocking capability. Use the <+> or <-> key to adjust the value. The values range from 0.001V to 0.999V at 0.001V increment.

CPU Analog I/O Voltage Offset Mode Sign [+]

- [+] To offset the voltage by a positive value.
- [-] To offset the voltage by a negative value.

CPU Analog I/O Voltage Offset [Auto]

This item allows you to set the amount of voltage fed for the analog portion of the I/O on the CPU. Setting a high analog I/O voltage may enhance overclocking capability. Use the <+> or <-> key to adjust the value. The values range from 0.001V to 0.999V at 0.001V increment.

CPU Digital I/O Voltage Offset Mode Sign [+]

- [+] To offset the voltage by a positive value.
- [-] To offset the voltage by a negative value.

CPU Digital I/O Voltage Offset [Auto]

This item allows you to set the amount of voltage fed for the digital portion of the I/O on the CPU. Setting a high digital I/O voltage may enhance the overclocking capability. Use the <+> or <-> key to adjust the value. The values range from 0.001V to 0.999V at 0.001V increment.

SVID Support [Auto]

Set this item to [Enabled] when overclocking. Disabling this item prevents the CPU from communicating with the external voltage regulator.

Configuration options: [Auto] [Disabled] [Enabled]



The following items appear only when you set the CPU Core Voltage to **[Auto]** or **[Disabled]**.

Initial CPU Input Voltage [Auto]

This item allows you to set a VCCIN for the CPU during initial part of POST. Use the <+> or <-> key to adjust the value. The values range from 0.80V to 2.440V at 0.010V increment.

Eventual CPU Input Voltage [Auto]

This item allows you to set a VCCIN for the CPU before OS loading. Use the <+> or <-> key to adjust the value. The values range from 0.80V to 2.440V at 0.010V increment.

DRAM Voltage [Auto]

This item allows you to set the voltage for the system memory. Use the <+> or <-> key to adjust the value. The values range from 1.20V to 2.40V at 0.005V increment.



According to Intel® CPU specifications, DIMMs with voltage requirement over 1.65 V may damage the CPU permanently. We recommend that you install the DIMMs with the voltage requirement below 1.65 V.

PCH Core Voltage [Auto]

This item allows you to set the Core voltage for the PCH (Platform Controller Hub). You can use the <+> or <-> keys to adjust the value. The values range from 0.70 V to 1.80 V with a 0.0125 V interval.



- The values of the CPU PLL Voltage, CPU Manual Voltage, CPU Offset Voltage, iGPU Manual Voltage, iGPU Offset Voltage, DRAM Voltage, VCCSA Voltage, VCCIO Voltage, and PCH Voltage items are labeled in different color, indicating the risk levels of high voltage settings.
 - The system may need better cooling system for a more stable performance under high voltage.
-

PCH VLX Voltage [Auto]

This item allows you to set the I/O voltage of the PCH VLX. Use the <+> or <-> key to adjust the value. The values range from 0.8000V to 2.0000V at 0.00625V increment.

VTTDDR Voltage [Auto]

This item allows you to set the termination voltage for the system memory. Use the <+> or <-> key to adjust the value. The values range from 0.6000V to 1.4000V at 0.00625V increment.

DRAM CTRL REF Voltage [Auto]

This item allows you to configure the DRAM reference voltage on the control lines. The reference voltage is the DRAM voltage times the configured value. Use the <+> or <-> key to adjust the value. The values range from 0.3950x to 0.6300 at 0.0050x increment.

DRAM DATA REF Voltage on CHA/CHB [Auto]

This item allows you to configure the DRAM reference voltage on the data lines of channels A and B. The reference voltage is the DRAM voltage times the configured value. Use the <+> or <-> key to adjust the value. The values range from 0.3950x to 0.6300 at 0.0050x increment.

CPU Spread Spectrum [Auto]

This item allows you to enhance the BCLK overclocking capability or reduce the EMI (electromagnetic disturbance) generated by the BCLK.

- [Auto] Default configuration
- [Enabled] Reduces the EMI generated by the BCLK.
- [Disabled] Enhances the BCLK (base clock) overclocking ability.

BCLK Recovery [Enabled]

This item allows you to enable or disable the BCLK (base clock) recovery feature.

Configuration options: [Enabled] [Disabled] [Ignore]

3.5 Main menu

The Main menu screen appears when you enter the Advanced Mode of the BIOS Setup program. The Main menu provides you an overview of the basic system information, and allows you to set the system date, time, language, and security settings.

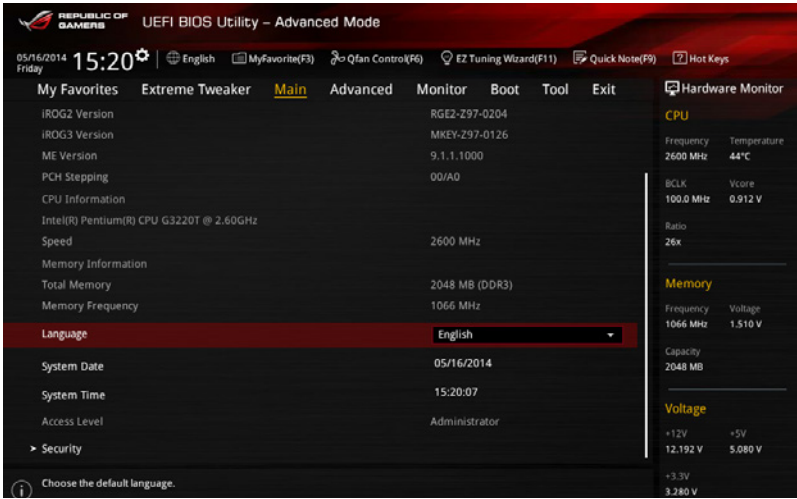

Security

The Security menu items allow you to change the system security settings.

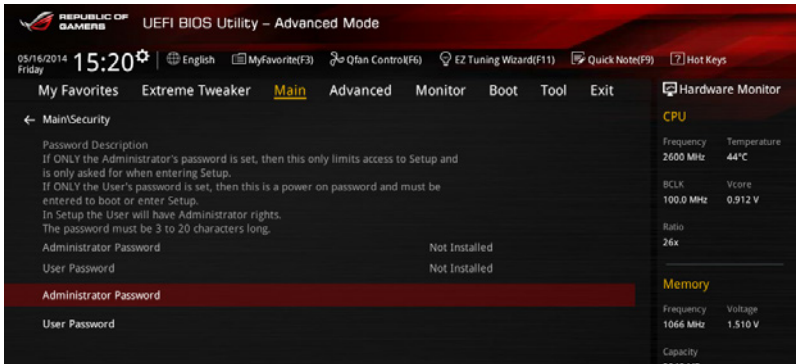

- If you have forgotten your BIOS password, erase the CMOS Real Time Clock (RTC) RAM to clear the BIOS password. See section 1.2.6 Onboard buttons for information on how to erase the RTC RAM via the Clear CMOS button.
- The Administrator or User Password items on top of the screen show the default [Not Installed]. After you set a password, these items show [Installed].

Administrator Password

If you have set an administrator password, we recommend that you enter the administrator password for accessing the system. Otherwise, you might be able to see or change only selected fields in the BIOS setup program.

To set an administrator password:

1. Select the **Administrator Password** item and press <Enter>.
2. From the **Create New Password** box, key in a password, then press <Enter>.
3. Confirm the password when prompted.

To change an administrator password:

1. Select the **Administrator Password** item and press <Enter>.
2. From the **Enter Current Password** box, key in the current password, then press <Enter>.
3. From the **Create New Password** box, key in a new password, then press <Enter>.
4. Confirm the password when prompted.

To clear the administrator password, follow the same steps as in changing an administrator password, but press <Enter> when prompted to create/confirm the password. After you clear the password, the **Administrator Password** item on top of the screen shows **Not Installed**.

User Password

If you have set a user password, you must enter the user password for accessing the system. The User Password item on top of the screen shows the default Not Installed. After you set a password, this item shows Installed.

To set a user password:

1. Select the **User Password** item and press <Enter>.
2. From the **Create New Password** box, key in a password, then press <Enter>.
3. Confirm the password when prompted.

To change a user password:

1. Select the **User Password** item and press <Enter>.
2. From the **Enter Current Password** box, key in the current password, then press <Enter>.
3. From the **Create New Password** box, key in a new password, then press <Enter>.
4. Confirm the password when prompted.

To clear the user password, follow the same steps as in changing a user password, but press <Enter> when prompted to create/confirm the password. After you clear the password, the **User Password** item on top of the screen shows **Not Installed**.

3.6 Advanced menu

The Advanced menu items allow you to change the settings for the CPU and other system devices.



Be cautious when changing the settings of the Advanced menu items. Incorrect field values can cause the system to malfunction.

The screenshot displays the ASUS UEFI BIOS Utility in Advanced Mode. The top bar includes the Republic of Gamers logo, the title 'UEFI BIOS Utility - Advanced Mode', and a date/time display of '05/16/2014 Friday 15:18'. Below the title are utility icons for English, MyFavorite(F3), Qfan Control(F6), EZ Tuning Wizard(F11), Quick Note(F9), and Hot Keys. The main menu on the left lists options: My Favorites, Extreme Tweaker, Main, **Advanced**, Monitor, Boot, Tool, and Exit. Under 'Advanced', several sub-menus are listed with expandable arrows: CPU Configuration, PCH Configuration, PCH Storage Configuration, System Agent Configuration, USB Configuration, Platform Misc Configuration, Onboard Devices Configuration, APM Configuration, Network Stack Configuration, and ROG Effects. At the bottom of this list is 'Intel(R) Rapid Storage Technology'. The right side of the screen shows 'Hardware Monitor' with three sections: 'CPU' (Frequency: 2600 MHz, Temperature: 44°C, BCLK: 100.0 MHz, Vcore: 0.912 V, Ratio: 26x), 'Memory' (Frequency: 1066 MHz, Voltage: 1.517 V, Capacity: 2048 MB), and 'Voltage' (+1.2V: +5V, 12.192 V: 5.080 V, +3.3V: 3.280 V). The bottom status bar shows 'Last Modified | EzMode(F7)|' and 'Version 2.16.1240. Copyright (C) 2014 American Megatrends, Inc.'

3.6.1 CPU Configuration

The items in this menu show the CPU-related information that the BIOS automatically detects.



The items in this menu may vary based on the CPU installed.

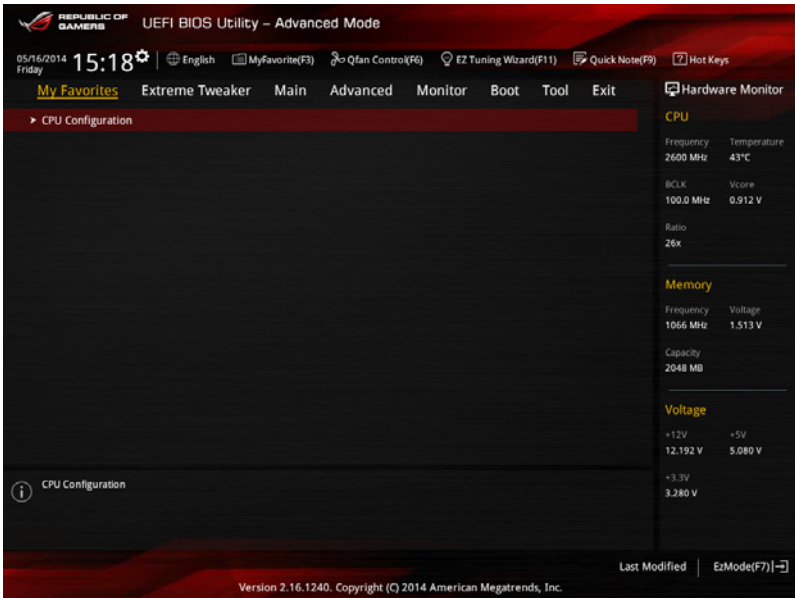

Intel Adaptive Thermal Monitor [Enabled]

This item allows you to protect the CPU by decreasing its frequency as it reaches the thermal throttle point. The thermal monitor includes TM1 (Thermal monitor 1), TM2 (Thermal monitor 2), and EMTTM (Enhanced Multi-threaded Thermal Monitoring).

Configuration options: [Disabled] [Enabled]

Active Processor Cores [All]

This item allows you to choose the number of CPU cores to activate in each processor package.

Configuration options: [All] [1]

Limit CPUID Maximum [Disabled]

When set to [Enabled], this item allows the legacy OS to boot even without support for CPUs with extended CPUID functions.

Configuration options: [Disabled] [Enabled]

Execute Disable Bit [Enabled]

Execute Disable prevents certain classes of malicious buffer overflow attacks when combined with a supporting OS (SuSE Linux 9.2, RedHat Enterprise 3 Update 3).

Configuration options: [Disabled] [Enabled]

Intel® Virtualization Technology [Disabled]

This item makes a single system appear as multiple independent systems to software. This allows multiple or independent operating systems to run simultaneously on a single system.

Configuration options: [Disabled] [Enabled]

Hardware Prefetcher (L2 Cache) [Enabled]

This item allows the CPU to prefetch commands and data in the L2 cache, reduces the DRAM loading time and improves the system performance.

Configuration options: [Disabled] [Enabled]

Adjacent Cache Line Prefetcher [Enabled]

This item allows the mid level cache (L2) to prefetch adjacent cache lines, reducing the DRAM loading time and improves the system performance.

Configuration options: [Disabled] [Enabled]

Boot Performance Mode [Max Non-Turbo Performance]

This item allows you to select the CPU performance state during system boot before the operating system takes control. The CPU runs at a selected performance ratio based on CPU configuration.

Configuration options: [Max Non-Turbo Performance] [Max Battery] [Turbo Performance]

Dynamic Storage Accelerator [Disabled]

This item allows you to accelerate the performance of the SSDs (Solid-State Drives) by dynamically adjusting the power management during heavy multitasking.

Configuration options: [Enabled] [Disabled]

CPU Power Management Configuration

The subitems in this menu allows you to manage and configure the CPU's power.

Enhanced Intel SpeedStep Technology [Enabled]

This item allows your system to adjust the CPU's voltage and cores frequency, resulting in decreased power consumption and heat production.

[Disabled] The CPU runs at its default speed.

[Enabled] The system controls the CPU speed.

CPU C-States [Auto]

This item allows you to set the power saving of the CPU states.

Configuration options: [Auto] [Disabled] [Enabled]



The following items appear only when you set the CPU C States to **[Enabled]**.

Enhanced C1 State [Enabled]

This item allows your CPU to reduce power consumption when the system is in idle mode.

Configuration options: [Enabled] [Disabled]

CPU C3 Report [Enabled]

This item allows you to disable or enable the CPU C3 report to the operating system.

Configuration options: [Enabled] [Disabled]

CPU C6 Report [Enabled]

This item allows you to disable or enable the CPU C6 report to the operating system.

Configuration options: [Enabled] [Disabled]

C6 Latency [Short]

This item allows you to set the duration of C6 latency for C6 state.

Configuration options: [Short] [Long]

CFG lock

This item allows you to enable or disable the MSR 0xE2 [15] CFG lock bit.

Configuration options: [Enabled] [Disabled]

Package C-States Support [Auto]

This item allows you to set the a C-state support for the CPU package.

Configuration options: [Auto] [Enabled] [C0/C1] [C2] [C3] [C6] [CPU C7] [CPU C7s]

3.6.2 PCH Configuration

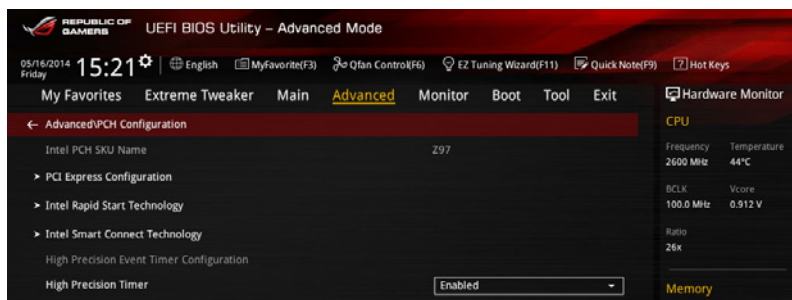

PCI Express Configuration

This item allows you to configure the PCI Express slots.

PCI-E Speed [Auto]

This item allows your system to automatically select the PCI-E port speed.

Configuration options: [Auto] [Gen1] [Gen2]

Intel (R) Rapid Start Technology [Disabled]

This item allows you to enable or disable Intel Rapid Start Technology.

Configuration options: [Enabled] [Disabled]



The following items appear only when you set the Intel® Rapid Start Technology to [Enabled].

Entry on S3 RTC Wake [Enabled]

The system automatically wakes up and set to Rapid Start Technology S4 mode.

Configuration options: [Enabled] [Disabled]

Entry After [0]

This item appears only when you set the Entry on S3 RTC Wake to [Enabled]. This item allows you to enable the RTC wake timer at S3 entry.

The value ranges from 0 (Immediately) to 120 minutes

Active Page Threshold Support [Enabled]

This item allows you to enable or disable the IRST with additional partition size.

Configuration options: [Enabled] [Disabled]



Ensure that the caching partition size is larger than the total memory size.

Active Memory Threshold [0]

This item appears only when you set the **Active Page Threshold Support** to [Enabled]. This item allows you to allocate a partition size for Active Page Threshold.

Hybrid Hard Disk Support [Disabled]

This item allows you to enable or disable Hybrid Hard Disk support.

Configuration options: [Enabled] [Disabled]

Intel (R) Smart Connect Technology

ISCT Support [Disabled]

This item allows you to enable or disable the Intel® Smart Connect Technology.

Configuration options: [Enabled] [Disabled]

High Precision Timer [Disabled]

This item allows you to enable or disable the High Precision Event Timer.

Configuration options: [Enabled] [Disabled]

3.6.3 PCH Storage Configuration

While entering Setup, the BIOS automatically detects the presence of SATA devices. The SATA Port items show **Empty** if no SATA device is installed to the corresponding SATA port. Scroll down to display the other BIOS items.

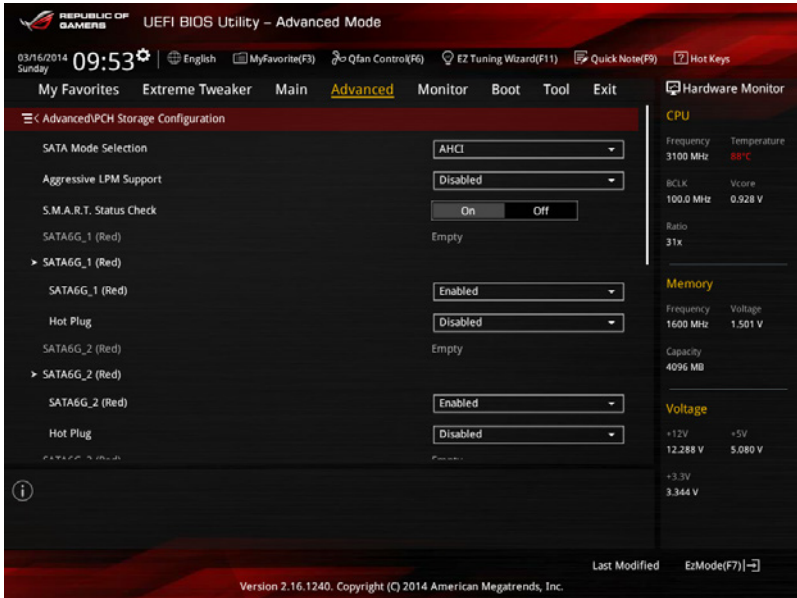

SATA Mode Selection [AHCI]

This item allows you to set the SATA configuration.

- [Disabled] Disables the SATA function.
- [IDE] Set to **[IDE]** when you want to use the Serial ATA hard disk drives as Parallel ATA physical storage devices.
- [AHCI] Set to **[AHCI]** when you want the SATA hard disk drives to use the AHCI (Advanced Host Controller Interface). The AHCI allows the onboard storage driver to enable advanced Serial ATA features that increases storage performance on random workloads by allowing the drive to internally optimize the order of commands.
- [RAID] Set to **[RAID]** when you want to create a RAID configuration from the SATA hard disk drives.



The following item appears only when you set the SATA Mode Selection to **[RAID]**.

Alternate ID [Disabled]

This item allows you to enable or disable Report alternate ID. Configuration options: [Disabled] [Enabled]

Aggressive LPM Support [Disabled]

This item is designed for LPM (link power management) support with a better energy saving conditions. When set to [Enabled], the hot plug function of SATA ports are disabled.

Configuration options: [Disabled] [Enabled]

S.M.A.R.T. Status Check [Enabled]

S.M.A.R.T. (Self-Monitoring, Analysis and Reporting Technology) is a monitoring system that shows a warning message during POST (Power-on Self Test) when an error occurs in the hard disks. Press <Enter> to set this item On or Off.

Configuration options: [On] [Off]

Hot Plug [Disabled] (SATA6G_1 - SATA6G_4 [Red])

These items appear only when you set the SATA Mode Selection item to [AHCI] or [RAID], and allow you to enable/disable SATA Hot Plug Support.

Configuration options: [Disabled] [Enabled]

3.6.4 System Agent Configuration

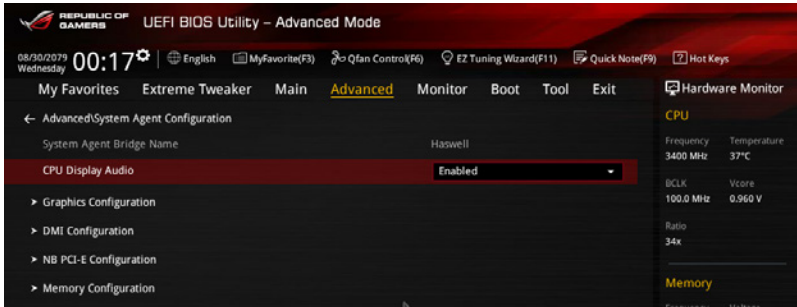

CPU Display Audio [Enabled]

Enable this item for the CPU display audio support.

Configuration options: [Enabled] [Disabled]

Graphics Configuration

The items in this sub-menu allows you to select a primary display from iGPU, and PCIe graphical devices.

Primary Display [Auto]

This item allows you to select a primary display from iGPU, and PCIe graphical devices.

[Auto] The primary display is set to PCI-E when a PCI-E graphic card is detected.

[CPU Graphics] Force the primary display to be from the CPU Graphics.

[PCI-E] Force the primary display to be from the PCI-E graphic cards.

CPU Graphics Memory [Auto]

This item allows you to select the amount of system memory allocated to DVMT 5.0 used by the CPU graphics.

Configuration options: [Auto] [32M] [64M] [96M] [128M] [160M] [192M] [224M] [256M] [288M] [320M] [352M] [384M] [416M] [448M] [480M] [512M]

Render Standby [Auto]

This item allows you to enable the Intel® Graphics Render Standby support to reduce iGPU power use when the system is idle.

Configuration options: [Auto] [Disabled] [Enabled]

CPU Graphics Multi-Monitor [Disabled]

Enable this item for the Intel graphics render standby support to reduce the iGPU power consumption when the system is idle.

Configuration options: [Disabled] [Enabled]

DMI Configuration

Enable this item for the DMI (Direct media interface) to run at PCI-E 2.0 speed.

DMI Gen 2 [Enabled]

Configuration options: [Enabled] [Disabled]

NB PCI-E Configuration

This item allows you to configure the NB PCI Express settings.

PCIEx16 Link Speed [Auto]

This item allows you to select the operating speed of the PCI-EX16 speed.

Configuration options:

- [Auto] The system automatically selects the PCI-E x16 port speed.
- [Gen1] The PCI-EX16 port runs at PCI-E 1.0 speed.
- [Gen2] The PCI-EX16 port runs at PCI-E 2.0 speed.
- [Gen3] The PCI-EX16 port runs at PCI-E 3.0 speed.

Memory Configuration

This item allows you to configure the memory configuration parameters.

Memory Scrambler [Enabled]

This item allows you to support high frequency DRAMs for better stability.

Configuration options: [Enabled] [Disabled]

Memory Remap [Enabled]

This item allows you to support the DRAM address remapping function for 64-bit operating systems.

Configuration options: [Enabled] [Disabled]

3.6.5 USB Configuration

The items in this menu allow you to change the USB-related features.

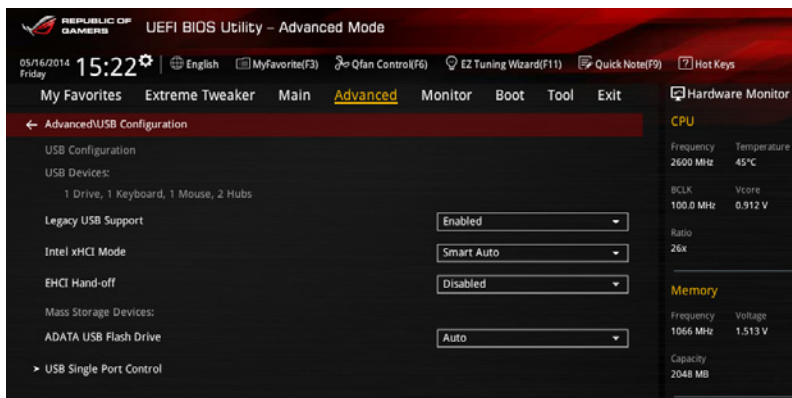

The **USB Devices** item shows the auto-detected values. If no USB device is detected, the item shows **None**.

Legacy USB Support [Enabled]

- [Disabled] The USB devices can be used only for the BIOS setup program. It cannot be recognized in boot devices list.
- [Enabled] Enables the support for USB devices on legacy operating systems (OS).
- [Auto] Allows the system to detect the presence of USB devices at startup. If detected, the USB controller legacy mode is enabled. If no USB device is detected, the legacy USB support is disabled.

Intel xHCI Mode [Smart Auto]

- [Smart Auto] Once the xHCI driver has been detected, the USB 3.0 mode will be supported during both POST and operating system.
- [Auto] xHCI controller will be enabled and run at USB 3.0 mode when the xHCI driver is installed in the operating system.
- [Enabled] Enables the xHCI controller.
- [Disabled] Disables the xHCI controller.

EHCI Hand-off [Disabled]



This item is set to [Disabled] by default for the EHCI (enhanced host controller interface) support by EHCI drivers in operating systems.

- [Enabled] Enables the support for operating systems without an EHCI hand-off feature.
- [Disabled] Disables the EHCI Hand-off support.

USB Single Port Control

Allows you to enable or disable the individual USB port.



Refer to section 1.2.2 **Motherboard layout** for the location of the USB ports.

3.6.6 Platform Misc Configuration

The items in this menu allow you to configure the platform-related features.

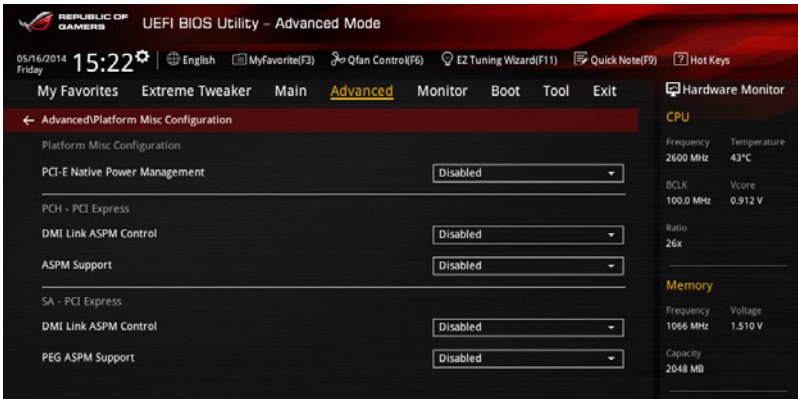

PCI Express Native Power Management [Disabled]

This item allows you to enhance the power saving feature of PCI Express and perform ASPM operations in the operating system.

Configuration options: [Disabled] [Enabled]



The following item appears only when you set the PCI Express Native Power Management to [Enabled].

Native ASPM [Disabled]

[Enabled] Vista controls the ASPM support for the device.

[Disabled] BIOS controls the ASPM support for the device.

PCH - PCI Express

DMI Link ASPM Control [Disabled]

This item is for the control of the Active State Power Management on both NB and SB side of the DMI link.

Configuration options: [Enabled] [Disabled]

ASPM Support [Disabled]

This item allows you to select an ASPM (Active State Power Management) state for energy saving conditions.

Configuration options: [Disabled] [L0s] [L1] [L0sL1] [Auto]

SA - PCI Express

DMI Link ASPM Control [Disabled]

Enable the PCH side ASPM for energy saving support.

Configuration options: [Disabled] [L0s] [L1s] [L0sL1]

PEG ASPM Control [Disabled]

Select the ASPM states for energy saving conditions.

Configuration options: [Disabled] [Auto] [ASPM L0s] [L1] [L0sL1]

3.6.7 Onboard Devices Configuration

Scroll down to view the other BIOS items.

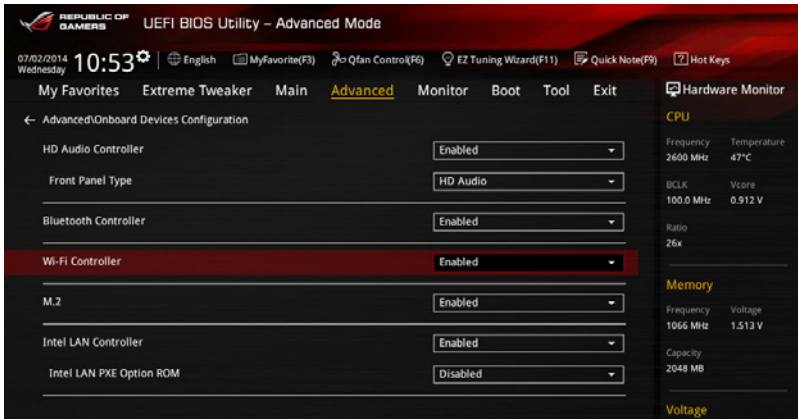

HD Audio Controller [Enabled]

[Enabled] Enables the High Definition Audio Controller.

[Disabled] Disables the controller.



The following items appear only when you set the HD Audio Controller to **[Enabled]**.

Front Panel Type [HD Audio]

This item allows you to set the front panel audio connector (AAFP) mode to legacy AC'97 or high-definition audio depending on the audio standard that the front panel audio module supports.

[HD Audio] Sets the front panel audio connector (AAFP) mode to high definition audio.

[AC97] Sets the front panel audio connector (AAFP) mode to legacy AC'97

Bluetooth Controller [Enabled]

This item allows you to enable or disable the Bluetooth controller.

Configuration options: [Disabled] [Enabled]

Wi-Fi Controller [Enabled]

This item allows you to enable or disable the Wi-Fi controller.

Configuration options: [Disabled] [Enabled]

M.2 [Enabled]

This item allows you to enable or disable M.2 feature.

Configuration options: [Disabled] [Enabled]

Intel LAN Controller [Enabled]

This item allows you to enable or disable the Intel LAN Controller.

Configuration options: [Disabled] [Enabled]

Intel LAN PXE Option ROM [Disabled]

This item appears only when Intel LAN Controller is set to **[Enabled]**. This item allows you to enable or disable the Intel LAN preboot execution environment (PXE) option ROM. Configuration options: [Disabled] [Enabled]

3.6.8 APM

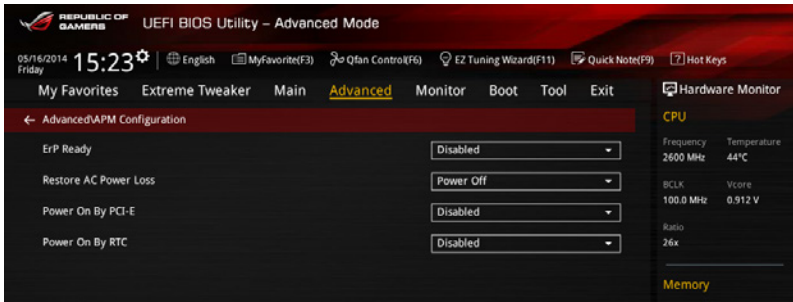

ErP Ready [Disabled]

This item allows you to switch off some power at S4+S5 or S5 to get the system ready for ErP requirement. When set to **[Enabled]**, all other PME options are switched off.

Configuration options: [Disabled] [Enabled (S4+S5)] [Enabled (S5)]

Restore AC Power Loss [Power Off]

[Power On] The system goes into ON state after an AC power loss.

[Power Off] The system goes into OFF state after an AC power loss.

[Last State] The system goes into either OFF or ON state, whatever the system state was before the AC power loss.

Power On By PCI-E/PCI [Disabled]

[Disabled] Disables the PCIE/PCI devices to generate a wake-on-LAN feature of the Intel®/Realtek LAN device or other installed PCIE LAN devices.

[Enabled] Enables the PCIE/PCI devices to generate a wake-on-LAN feature of the PCIE LAN devices.

Power On By RTC [Disabled]

[Disabled] Disables RTC to generate a wake event.

[Enabled] When set to **[Enabled]**, the items **RTC Alarm Date (Days)** and **Hour/Minute/Second** will become user-configurable with set values.

3.6.9 Network Stack Configuration

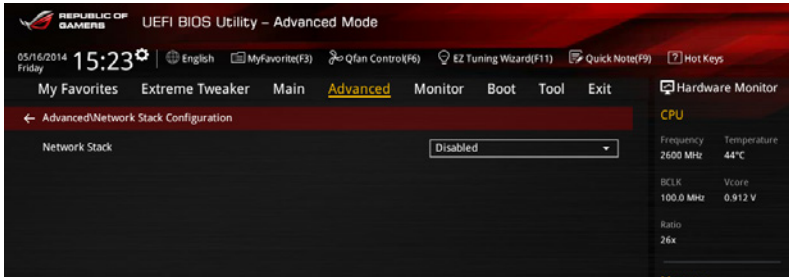

Network Stack [Disabled]

This item allows you to disable or enable the UEFI network stack.

Configuration options: [Disabled] [Enable]



The following items appear only when you set the Network Stack to **[Enabled]**.

Ipv4/Ipv6 PXE Support [Enabled]

This item allows you to enable or disable the Ipv4/Ipv6 PXE boot option.

Configuration options: [Disabled] [Enabled]

3.6.10 ROG Effects

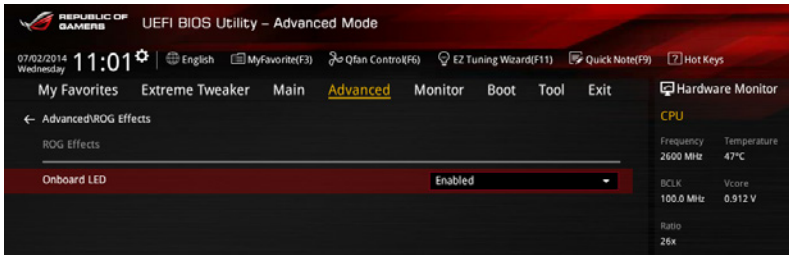

Onboard LED [Enabled]

This item allows you to enable all the onboard LEDs.

Configuration options: [Enabled] [Disabled]

3.6.11 Intel(R) Rapid Storage Technology

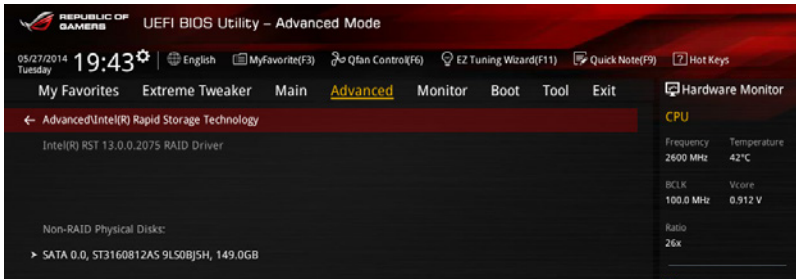

Create RAID Volume

This item allows you to create a RAID volume.



This item only appears when at least one HDD is connected to the Intel® SATA ports and set to RAID mode.

Name [Volume1]

This item allows you to key in a volume name for your RAID setup.



Use only alphanumeric characters for your RAID volume name. It should be 16 characters or less.

RAID Level [RAID0(Stripe)]

This item allows you to select the RAID level.

Configuration options: [RAID0(Stripe)] [RAID1(Mirror)] [RAID5(Parity)] [Recovery]

Select Disks

This item shows the connected SATA devices compatible for setting up RAID. On their dropdown lists, select **X** to set up the RAID.

Strip Size: [32KB]

This item allows you to strip the size of your RAID setup.

Configuration options: [4KB] [8KB] [16KB] [32KB] [64KB] [128KB]

Capacity (MB): [0]

This item allows you to set the RAID capacity.

3.7 Monitor menu

The Monitor menu displays the system temperature/power status, and allows you to change the fan settings.

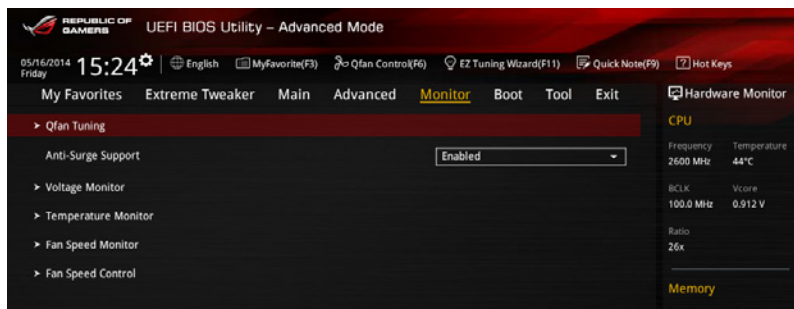

Qfan Tuning

Click this item to automatically detect the lowest speed and configure the minimum duty cycle for each fan.

Anti Surge Support [Enabled]

This item allows you to enable or disable the Anti Surge function.

Configuration options: [Disabled] [Enabled]

Voltage Monitor

CPU Core 0-1 Voltage; CPU Cache Voltage; CPU System Agent Voltage; CPU Analog I/O Voltage; CPU Digital I/O Voltage; CPU Input Voltage; CPU Input Voltage; DRAM Voltage; PCH Voltage; 3.3V Voltage; 5V Voltage; 12V Voltage

The onboard hardware monitor automatically detects the voltage output through the onboard voltage regulators. Press <Enter> and select [Ignore] if you do not wish to display the detected temperatures.

Temperature Monitor

CPU Temperature; MB Temperature; VRM Temperature [xxx°C/xxx°F]

The onboard hardware monitor automatically detects and displays the CPU, voltages, and motherboard. Press <Enter> and select [Ignore] if you do not wish to display the detected temperatures.

Fan Speed Monitor

CPU FAN Speed Chassis FAN1/2/3 Speed [XXXX RPM]

The onboard hardware monitor automatically detects and displays the CPU fan and chassis fan speeds in rotations per minute (RPM). If any of the fans is not connected to the motherboard, the field shows [N/A]. These items are not user-configurable. Press <Enter> and select [Ignore] if you do not wish to display the detected temperatures.

CPU Q-Fan Control [Auto]

This item allows you to set the CPU Q-Fan operating mode.

- [Auto] Detects the type of CPU fan installed and automatically switches the control modes.
- [PWM Mode] Enables the CPU Q-Fan control feature in PWM mode for 4-pin CPU fan.
- [DC Mode] Enables the CPU Q-Fan control feature in DC mode for 3-pin CPU fan.
- [Disabled] Disables the Q-Fan control.



The following items appear only when you set the CPU Q-Fan Control to **[Auto]**, **[PWM Mode]**, and **[DC Mode]**.

CPU Fan Speed Low Limit [300 RPM]

This item allows you to set the low limit warning for CPU Fan speed.

Configuration options: [Ignore] [200 RPM] [300 RPM] [400 RPM] [500 RPM] [600 RPM]

CPU Fan Profile [Standard]

This item allows you to set the appropriate performance level of the CPU fan.

- [Standard] Set to make the CPU fan adjust automatically depending on the CPU temperature.
- [Silent] Set to minimize the fan speed for quiet CPU fan operation.
- [Turbo] Set to achieve maximum CPU fan speed.
- [Manual] Set to assign the detailed fan speed control parameters.



The following items appear only when you set the CPU Fan Profile to **[Manual]**.

CPU Upper Temperature [70]

Use the <+> or <-> keys to adjust the upper limit of the CPU temperature. The values range from 20°C to 75°C.

CPU Fan Max. Duty Cycle(%) [100]

Use the <+> or <-> keys to adjust the maximum CPU fan duty cycle. The values may differ via Qfan tuning.

CPU Middle Temperature [25]

Use the <+> or <-> keys to set the value for CPU Middle Temperature. The range of the values depends on the CPU installed.

CPU Fan Middle Duty Cycle(%) [20]

Use the <+> or <-> keys to adjust the CPU fan middle duty cycle. The values may differ via Qfan tuning.

CPU Lower Temperature [20]

Use the <+> or <-> keys to adjust the CPU fan's lower temperature. The values range from 20% to 75%.

CPU Fan Min. Duty Cycle(%) [20]

Use the <+> or <-> keys to adjust the minimum CPU fan duty cycle. The values may differ via Qfan tuning.

Chassis Fan 1-3 Q-Fan Control [Enabled]

These items allow you to enable or disable the chassis fans' Q-Fan control feature of your motherboard.

Configuration options: [Disabled] [Enabled]

Chassis Fan 1-3 Speed Low Limit [300 RPM]

This item allows you to disable or set the chassis fan warning speed.

Configuration options: [Ignore] [200 RPM] [300 RPM] [400 RPM] [500 RPM] [600 RPM]

Chassis Fan 1-3 Profile [Standard]

This item allows you to set the appropriate performance level of the chassis fan.

[Standard] Set to make the chassis fan adjust automatically depending on the chassis temperature.

[Silent] Set to minimize the fan speed for quiet chassis fan operation.

[Turbo] Set to achieve maximum chassis fan speed.

[Manual] Set to assign detailed fan speed control parameters.



The following items appear only when you set the Chassis Fan Profile to **[Manual]**.

Chassis Fan 1-3 Upper Temperature [70]

Use the <+> or <-> keys to adjust the upper limit of the CPU temperature. The values range from 40°C to 90°C.

Chassis Fan 1-3 Max. Duty Cycle(%) [100]

Use the <+> or <-> keys to adjust the maximum chassis fan duty cycle. The values may differ via Qfan tuning.

Chassis Fan 1-3 Middle Temperature [45]

Use the <+> or <-> keys to set the value for Chassis Fan Middle Temperature.

Chassis Fan 1-3 Middle Duty Cycle(%) [60]

Use the <+> or <-> keys to adjust the chassis fan middle duty cycle. The values may differ via Qfan tuning.

Chassis Fan 1-3 Lower Temperature [40]

Use the <+> or <-> keys to adjust the chassis fans' lower temperature. The values may differ via Qfan tuning.

Chassis Fan 1-3 Min. Duty Cycle(%) [60]

Use the <+> or <-> keys to adjust the minimum chassis fan duty cycle. The values may differ via Qfan tuning.

3.8 Boot menu

The Boot menu items allow you to change the system boot options. Scroll down to display the other BIOS items.

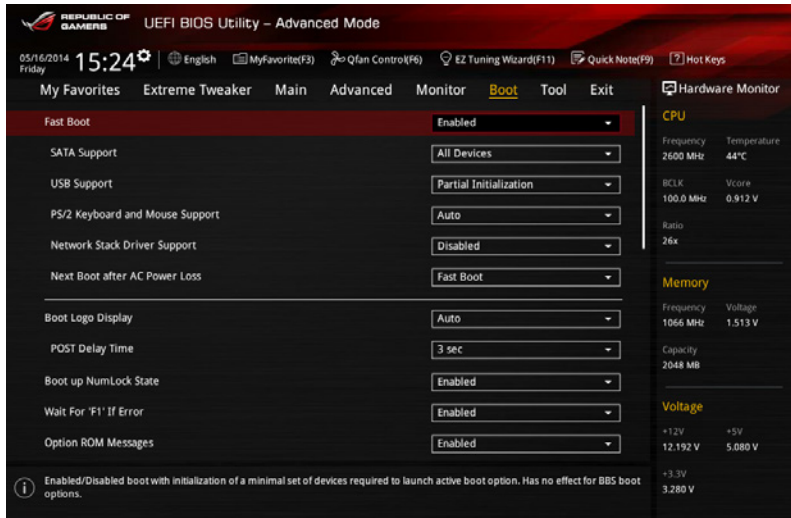

Boot Configuration

Fast Boot [Enabled]

[Disabled] This item allows your system to go back to its normal boot speed.

[Enabled] This item allows your system to accelerate the boot speed.



The following items appear only when you set the Fast Boot to **[Enabled]**.

SATA Support [All Devices]

[All Devices] All devices connected to SATA ports are available during POST. This process extends the POST time.

[Hard Drive Only] Only hard drives connected to SATA ports are detected during POST.

[Boot Drive Only] Only boot drives connected to a SATA ports are detected during POST.

USB Support [Partial Initialization]

[Disabled] All USB devices will not be available until OS boot up for a fastest POST time.

[Full Initialization] All USB devices will be available during POST. This process will extend the POST time.

[Partial Initialization] For a faster POST time, only USB ports with keyboard and mouse connections will be detected.

PS/2 Keyboard and Mouse Support [Auto]

This item allows you to disable or have full system control of the PS/2 devices' availability during POST.

Configuration options: [Auto] [Disabled] [Full Initialization]

Network Stack Driver Support [Disabled]

[Disabled] Select to skip the network stack driver from loading during POST.

[Enabled] Select to load the network stack driver during POST.

Next Boot after AC Power Loss [Normal Boot]

[Normal Boot] Returns to normal boot on the next boot after an AC power loss.

[Fast Boot] Accelerates the boot speed on the next boot after an AC power loss.

Boot Logo Display [Auto]

[Auto] Sets the boot logo to display during POST.

[Full Screen] Sets the boot logo display in full screen during POST.

[Disabled] Disables the boot logo display during POST.



The following item appears only when you set the Boot Logo Display to **[Auto]** and **[Full Screen]**.

Post Delay Time [3 sec]

This item allows you to select a desired additional POST waiting time to easily enter the BIOS Setup. You can only execute the POST delay time during normal boot. The values range from 0 to 10 seconds.



This feature only works when set under normal boot.



The following items appear only when you set the Boot Logo Display to **[Disabled]**.

Post Report [5 sec]

This item allows you to select a desired POST report waiting time.

Configuration options: [1 sec] - [10 sec] [Until Press ESC]

Bootup NumLock State [Enabled]

This item allows you to enable or disable power-on state of the NumLock.

Configuration options: [Disabled] [Enabled]

Wait For 'F1' If Error [Enabled]

This item allows your system to wait for the <F1> key to be pressed when error occurs.

Configuration options: [Disabled] [Enabled]

Option ROM Messages [Enabled]

- [Enabled] The option ROM messages are shown during POST (Power-on Self-Test).
[Disabled] Only the ASUS logo is shown during POST.

Interrupt 19 Capture [Disabled]

When set to [Enabled], it allows the option ROMs to trap Interrupt 19.

Configuration options: [Enabled] [Disabled]

Above 4G Decoding [Disabled]

This item enables or disables 64-bit capable devices to be decoded in above 4G address space if your system supports 64-bit PCI Decoding.

Configuration options: [Enabled] [Disabled]

Setup Mode [Advanced Mode]

- [Advanced Mode] Sets Advanced Mode as the default screen for entering the BIOS setup program.
[EZ Mode] Sets EZ Mode as the default screen for entering the BIOS setup program.

CSM (Compatibility Support Module)

Allows you to configure the CSM (Compatibility Support Module) items to fully support the various VGA, bootable devices and add-on devices for better compatibility.

Launch CSM [Enabled]

- [Auto] The system automatically detects the bootable devices and the add-on devices.
[Enabled] For better compatibility, enable the CSM to fully support the non-UEFI driver add-on devices or the Windows® UEFI mode.
[Disabled] Disable the CSM to fully support the non-UEFI driver add-on devices or the Windows® UEFI mode.



The following items appear when you set the Launch CSM to **[Enabled]**.

Boot Devices Control [UEFI and Legacy OpROM]

This item allows you to select the type of devices that you want to boot.

Configuration options: [UEFI and Legacy OpROM] [Legacy OpROM only] [UEFI only]

Boot from Network Devices [Legacy OpROM first]

This item allows you to select the type of network devices that you want to launch.

Configuration options: [Legacy OpROM first] [UEFI driver first] [Ignore]

Boot from Storage Devices [Legacy OpROM first]

This item allows you to select the type of storage devices that you want to launch.

Configuration options: [Both, Legacy OpROM first] [Both, UEFI first]
[Legacy OpROM first] [UEFI driver first] [Ignore]

Boot from PCI-E/PCI Expansion Devices [Legacy OpROM first]

This item allows you to select the type of PCIe/PCI expansion devices that you want to launch.

Configuration options: [Legacy OpROM first] [UEFI driver first]

Secure Boot

This item allows you to configure the Windows® Secure Boot settings and manage its keys to protect the system from unauthorized access and malwares during POST.

OS Type [Windows UEFI Mode]

[Windows UEFI Mode] This item allows you to select your installed operating system. Execute the Microsoft® Secure Boot check. Only select this option when booting on Windows® UEFI mode or other Microsoft® Secure Boot compliant OS.

[Other OS] Get the optimized function when booting on Windows® non-UEFI mode. Microsoft® Secure Boot only supports Windows® UEFI mode.



The following item appears only when you set the OS Type to **[Windows UEFI mode]**.

Key Management

This allows you to manage the Secure Boot keys.

Install Default Secure Boot keys

This item allows you to immediately load the default Security Boot keys, Platform key (PK), Key-exchange Key (KEK), Signature database (db), and Revoked Signatures (dbx). When the default Secure Boot keys are loaded, the PK state will change from Unloaded mode to loaded mode.

Clear Secure Boot keys

This item appears only when you load the default Secure Boot keys. This item allows you to clear all default Secure Boot keys.

Save Secure Boot Keys

This item allows you to save the PK (Platform Keys) to a USB storage device.

PK Management

The Platform Key (PK) locks and secures the firmware from any permissible changes. The system verifies the PK before your system enters the OS.

Delete PK

This item allows you to delete the PK from your system. Once the PK is deleted, all the system's Secure Boot keys will not be active.

Configuration options: [Yes] [No]

Load PK from File

This item allows you to load the downloaded PK from a USB storage device.



The PK file must be formatted as a UEFI variable structure with time-based authenticated variable.

KEK Management

The KEK (Key-exchange Key or Key Enrollment Key) manages the Signature database (db) and Revoked Signature database (dbx).



Key-exchange Key (KEK) refers to Microsoft® Secure Boot Key-Enrollment Key (KEK).

Delete the KEK

This item allows you to delete the KEK from your system.

Configuration options: [Yes] [No]

Load KEK from File

This item allows you to load the downloaded KEK from a USB storage device.

Append KEK from File

This item allows you to load the additional KEK from a storage device for an additional db and dbx loaded management.



The KEK file must be formatted as a UEFI variable structure with time-based authenticated variable.

DB Management

The db (Authorized Signature database) lists the signers or images of UEFI applications, operating system loaders, and UEFI drivers that you can load on the single computer.

Delete the db

This item allows you to delete the db file from your system.

Configuration options: [Yes] [No]

Load db from File

This item allows you to load the downloaded db from a USB storage device.

Append db from File

This item allows you to load the additional db from a storage device so that more images can be loaded securely.



The db file must be formatted as a UEFI variable structure with time-based authenticated variable.

DBX Management

The dbx (Revoked Signature database) lists the forbidden images of db items that are no longer trusted and cannot be loaded.

Delete the dbx

This item allows you to delete the dbx file from your system.

Load dbx from File

This item allows you to load the downloaded dbx from a USB storage device.

Configuration options: [Yes] [No]

Append dbx from File

This item allows you to load the additional dbx from a storage device so that more db's images cannot be loaded.



The dbx file must be formatted as a UEFI variable structure with time-based authenticated variable.

Boot Option Priorities

These items specify the boot device priority sequence from the available devices. The number of device items that appears on the screen depends on the number of devices installed in the system.



- To access Windows® OS in Safe Mode, press <F8 > after POST (Windows® 8 not supported).
 - To select the boot device during system startup, press <F8> when ASUS Logo appears.
-

Boot Override

These item displays the available devices. The number of device items that appear on the screen depends on the number of devices installed in the system. Click an item to start booting from the selected device.

3.9 Tools menu

The Tools menu items allow you to configure options for special functions. Select an item then press <Enter> to display the submenu.

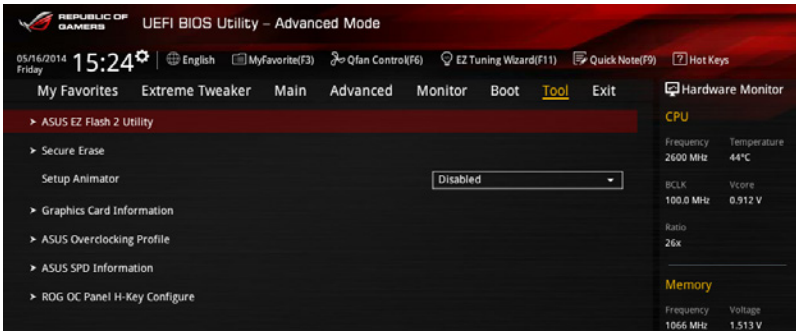

3.9.1 ASUS EZ Flash 2 Utility

This item allows you to run ASUS EZ Flash 2. When you press <Enter>, a confirmation message appears. Use the left/right arrow key to select between [Yes] or [No], then press <Enter> to confirm your choice.



For more details, refer to section [3.9.1 ASUS EZ Flash 2 Utility](#).

3.9.2 Secure Erase

SSD speeds may lower over time as with any storage medium due to data processing. Secure Erase completely and safely cleans your SSD, restoring it to factory performance levels.



Secure Erase is only available in AHCI mode. Ensure to set the SATA mode to AHCI. Click **Advanced > SATA Configuration > AHCI**.

To launch ROG SSD Secure Erase, click **Tool > ROG SSD Secure Erase** on the Advanced mode menu.



Check the ASUS support site for a full list of SSDs tested with Secure Erase. The drive may become unstable if you run Secure Erase on an incompatible SSD.



- The time to erase the contents of your SSD may take a while depending on its size. Do not turn off the system during the process.
- Secure Erase is only supported on Intel SATA port. For more information about Intel SATA ports, refer to section [1.2.2 Motherboard layout](#) of this manual.

Displays the available SSDs

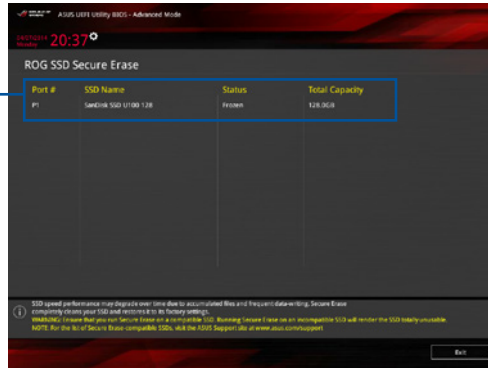

Status definition:

- **Frozen.** The frozen state is the result of a BIOS protective measure. The BIOS guards drives that do not have password protection by freezing them prior to booting. If the drive is frozen, a power off or hard reset of your PC must be performed to proceed with the Secure Erase.
- **Locked.** SSDs might be locked if the Secure Erase process is either incomplete or was stopped. This may be due to a third party software that uses a different password defined by ASUS. You have to unlock the SSD in the software before proceeding with Secure Erase.

3.9.3 Graphics Card Information

This item displays the information about the graphics card installed in your system.

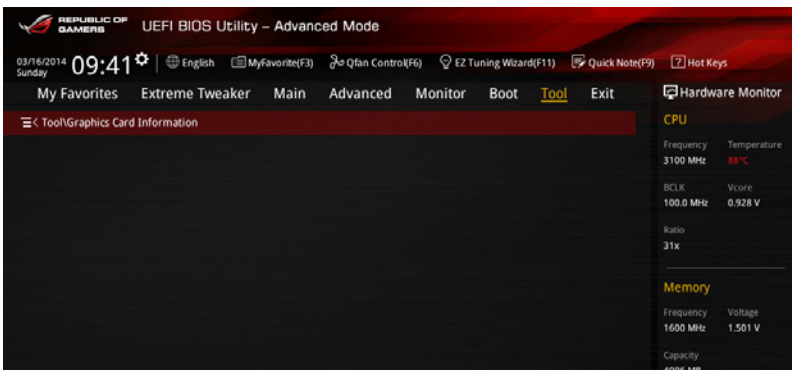

3.9.4 ASUS Overclocking Profile

This item allows you to store or load multiple BIOS settings.

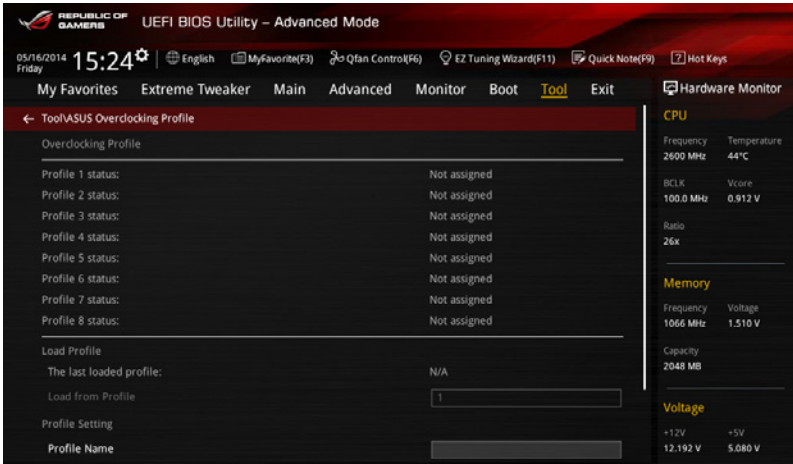

The O.C. Profile Configuration items show **Not Installed** if no profile is created.

Profile Name

Allows you to input a profile name to save the current BIOS settings.

Save to Profile

Allows you to save the current BIOS settings to the BIOS Flash, and create a profile. Key in a profile number from one to eight, press <Enter>, and then select **Yes**.

Load from Profile

Allows you to load the previous BIOS settings saved in the BIOS Flash. Key in the profile number that saved your BIOS settings, press <Enter>, and then select **Yes**.



- DO NOT shut down or reset the system while updating the BIOS to prevent the system boot failure!
- We recommend that you update the BIOS file only coming from the same memory/CPU configuration and BIOS version.

Load/Save CMOS Profile From/To USB drive

This item allows you to load or save CMOS profiles from or to the USB drive when clicked or selected.

3.9.5 ASUS SPD Information

Allows you to view the DRAM SPD information.

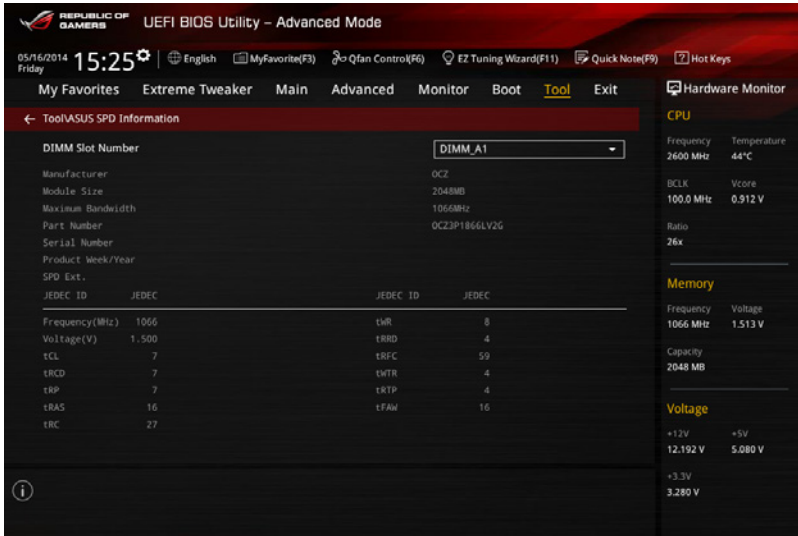

3.9.6 ROG OC Panel H-Key Configure

The ROG OC Panel H-Key Configure allows you to input and save values on the CPU core voltage, CPU input voltage, BCLK Frequency, and CPU ratio in the UEFI BIOS. The saved values can be synchronized to a compatible OC Panel device and these values can be tweaked or configured using the OC Panel without going to the BIOS menu.

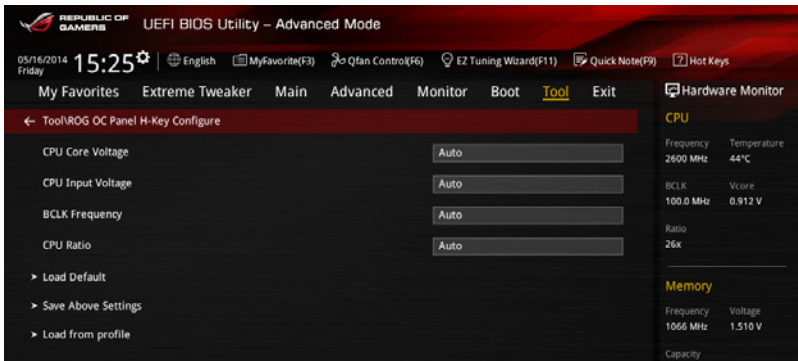

CPU Core Voltage [Auto]

This item allows you to configure the amount of voltage fed to the Cores of the processor. Increase the value when increasing Core Frequency. Use the <+> or <-> to adjust the value. The values range from 1.050000V to 2.200000V with a 0.003125V interval.

CPU Input Voltage [Auto]

This item allows you to configure the input voltage to the cores of the processor. Use the <+> or <-> key to raise the voltage by an increment of 0.010V. The minimum voltage is 0.800V and the maximum voltage is 3.040V.

BCLK Frequency [Auto]

This item allows you to input values to the Base Clock (BCLK) Frequency that ranges from 60 MHz to 300 MHz.

CPU Ratio [Auto]

This item allows you to adjust the CPU ratio. The CPU ratio may vary according to the model of the processor.

Load Default

This item allows you to load the default values of the CPU Core Voltage, CPU Input Voltage, BCLK Frequency, and CPU Ratio. The **Load Default** resets all values to **[Auto]**.

Save Above Settings

This item allows you to save the new values of the CPU Core Voltage, CPU Input Voltage, BCLK Frequency, and CPU Ratio.

Load from profile

This item allows you to load the previous values of the CPU Core Voltage, CPU Input Voltage, BCLK Frequency, and CPU Ratio.

3.10 Exit menu

The Exit menu items allow you to load the optimal default values for the BIOS items, and save or discard your changes to the BIOS items. You can access the EZ Mode from the Exit menu.

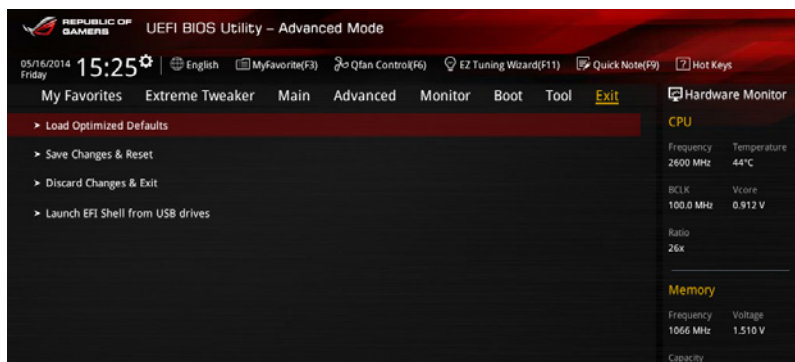

Load Optimized Defaults

This option allows you to load the default values for each of the parameters on the Setup menus. When you select this option or if you press <F5>, a confirmation window appears. Select **Yes** to load the default values.

Save Changes & Reset

Once you are finished making your selections, choose this option from the Exit menu to ensure the values you selected are saved. When you select this option or if you press <F10>, a confirmation window appears. Select **Yes** to save changes and exit.

Discard Changes & Exit

This option allows you to exit the Setup program without saving your changes. When you select this option or if you press <Esc>, a confirmation window appears. Select **Yes** to discard changes and exit.

ASUS EZ Mode

This option allows you to enter the EZ Mode screen.

Launch EFI Shell from filesystem device

This option allows you to attempt to launch the EFI Shell application (shellx64.efi) from one of the available filesystem devices.

3.11 Updating BIOS

The ASUS website publishes the latest BIOS versions to provide enhancements on system stability, compatibility, or performance. However, BIOS updating is potentially risky. If there is no problem using the current version of BIOS, DO NOT manually update the BIOS. Inappropriate BIOS updating may result in the system's failure to boot. Carefully follow the instructions of this chapter to update your BIOS if necessary.



Visit the ASUS website at www.asus.com to download the latest BIOS file for this motherboard.

The following utilities allow you to manage and update the motherboard BIOS setup program.

1. EZ Update: Updates the BIOS in Windows® environment.
2. ASUS EZ Flash 2: Updates the BIOS using a USB flash drive.
3. ASUS CrashFree BIOS 3: Restores the BIOS using the motherboard support DVD or a USB flash drive when the BIOS file fails or gets corrupted.
4. ASUS BIOS Updater: Updates and back ups the BIOS in DOS environment using the motherboard support DVD and a USB flash disk drive.

3.11.1 EZ Update

The EZ Update is a utility that allows you to update the motherboard BIOS in Windows® environment.



- EZ Update requires an Internet connection either through a network or an ISP (Internet Service Provider).
 - This utility is available in the support DVD that comes with the motherboard package.
 - Refer to section **4.4.6 EZ Update** of this user guide for more information.
-

3.11.2 ASUS EZ Flash 2

ASUS EZ Flash 2 allows you to update the BIOS without having to use a bootable floppy disk or an OS-based utility.



Before you start using this utility, download the latest BIOS from the ASUS website at www.asus.com.

To update the BIOS using EZ Flash 2:

1. Insert the USB flash disk that contains the latest BIOS file to the USB port.
2. Enter the Advanced Mode of the BIOS setup program. Go to the Tool menu to select ASUS EZ Flash Utility and press <Enter> to enable it.

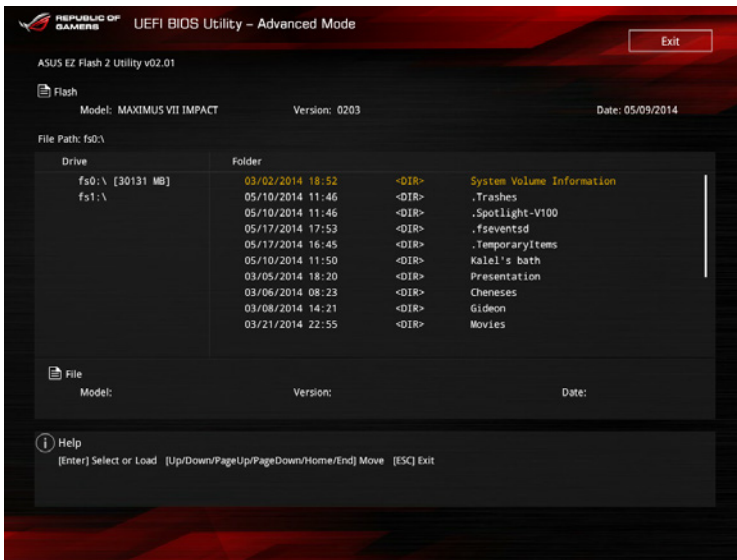

3. Press <Tab> to switch to the Drive field.
4. Press the Up/Down arrow keys to find the USB flash disk that contains the latest BIOS, and then press <Enter>.
5. Press <Tab> to switch to the Folder Info field.
6. Press the Up/Down arrow keys to find the BIOS file, and then press <Enter> to perform the BIOS update process. Reboot the system when the update process is done.



-
- This function can support devices such as a USB flash disk with FAT 32/16 format and single partition only.
 - DO NOT shut down or reset the system while updating the BIOS to prevent system boot failure!
-



Ensure to load the BIOS default settings to ensure system compatibility and stability. Select the Load Optimized Defaults item under the Exit menu. See section **3.10 Exit menu** for details.

3.11.3 ASUS CrashFree BIOS 3

The ASUS CrashFree BIOS 3 utility is an auto recovery tool that allows you to restore the BIOS file when it fails or gets corrupted during the updating process. You can restore a corrupted BIOS file using the motherboard support DVD or a USB flash drive that contains the BIOS file.



The BIOS file in the motherboard support DVD may be older than the BIOS file published on the ASUS official website. If you want to use the newer BIOS file, download the file at support.asus.com and save it to a USB flash drive.

Recovering the BIOS

To recover the BIOS:

1. Turn on the system.
2. Insert the motherboard support DVD to the optical drive, or the USB flash drive containing the BIOS file to the USB port.
3. The utility automatically checks the devices for the BIOS file. When found, the utility reads the BIOS file and enters ASUS EZ Flash 2 automatically.
4. The system requires you to enter BIOS Setup to recover the BIOS setting. To ensure system compatibility and stability, we recommend that you press <F5> to load default BIOS values.



DO NOT shut down or reset the system while updating the BIOS! Doing so can cause system boot failure!

3.11.4 ASUS BIOS Updater

ASUS BIOS Updater allows you to update the BIOS in DOS environment.



The screen captures used in this section are for reference only and may not be exactly the same as actually shown on your computer screen.

Before updating BIOS

- Prepare the motherboard support DVD and a USB flash drive.
- Download the latest BIOS file and BIOS Updater from <http://support.asus.com> and save them in your USB flash drive.



NTFS is not supported under DOS environment. Ensure that your USB flash drive is in single partition and in FAT32/16 format.

- Turn off the computer.
- Ensure that your computer has a DVD optical drive.

Booting the system in DOS environment

To boot the system in DOS:

1. Insert the USB flash drive with the latest BIOS file and BIOS Updater to the USB port.
2. Boot your computer then press <F8> to launch the select boot device screen.
3. When the select boot device screen appears, insert the Support DVD into the optical drive then select the optical drive as the boot device.

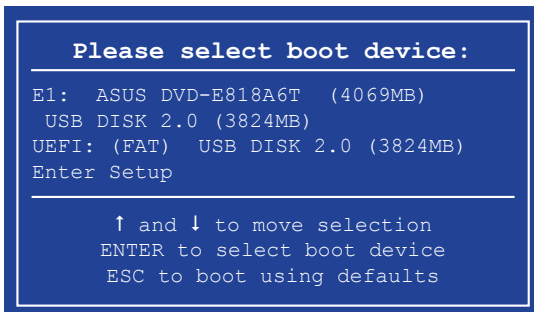

- When the booting message appears, press <Enter> within five (5) seconds to enter FreeDOS prompt.

```
ISOLINUX 3.20 2006-08-26 Copyright (C) 1994-2005 H. Peter Anvin
A Bootable DVD/CD is detected. Press ENTER to boot from the DVD/CD.
If no key is pressed within 5 seconds, the system will boot next priority
device automatically. boot:
```

- On the FreeDOS prompt, type **d:** then press <Enter> to switch the disk from Drive C (optical drive) to Drive D (USB flash drive).

```
Welcome to FreeDOS (http://www.freedos.org)!
C: /> d:
D: />
```

Updating the BIOS file

To update the BIOS file:

- On the FreeDOS prompt, type **bupdater /pc /g** and press <Enter>.

```
D: /> bupdater /pc /g
```

- On the BIOS Updater screen, press <Tab> to switch from Files panel to Drives panel then select **D:**.

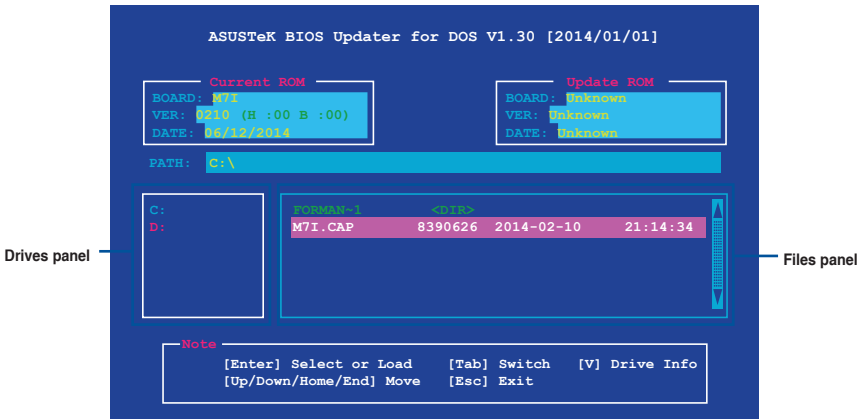

- Press <Tab> to switch from Drives panel to Files panel then press <Up/Down or Home/End> keys to select the BIOS file and press <Enter>.

4. After the BIOS Updater checks the selected BIOS file, select **Yes** to confirm the BIOS update.



The BIOS Backup feature is not supported due to security regulations.

5. Select **Yes** then press <Enter>. When BIOS update is done, press <ESC> to exit BIOS Updater.
6. Restart your computer.



DO NOT shut down or reset the system while updating the BIOS to prevent system boot failure.



Ensure to load the BIOS default settings to ensure system compatibility and stability. Select **Load Optimized Defaults** item under the **Exit BIOS menu**. See section **3.10 Exit menu** for details.

Software support

4

4.1 Installing an operating system



- This motherboard supports Windows® 8 32/64-bit and Windows® 7 32/64-bit operating systems (OS).
- Motherboard settings and hardware options vary. Use the setup procedures presented in this chapter for reference only. Refer to your OS documentation for detailed information.

4.2 Support DVD information



The contents of the support DVD are subject to change at any time without notice. Visit the ASUS website at www.asus.com for updates.

4.2.1 Running the support DVD



Ensure that you have an Administrator account before running the support DVD in Windows® 7 or Windows® 8 OS.

To run the support DVD:

1. Place the Support DVD into the optical drive.
2. In the **AutoPlay** dialog box, click **Run ASSETUP.exe**.

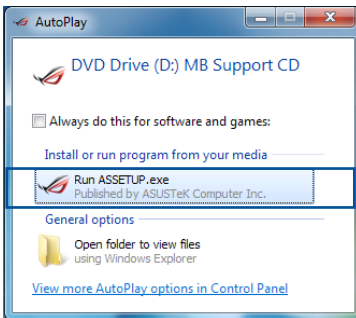

If the **AutoPlay** dialog box does not appear, browse the contents of the support DVD and double-click or tap `\\bin\ASSETUP.EXE` to launch the **ASUS motherboard support DVD** main menu.

Support DVD main menu

The Drivers menu shows the available device drivers if the system detects installed devices. Install the necessary drivers to use the devices.

The Manual menu contains the list of supplementary user manuals. Click an item to open the folder of the user manual.

The Video menu contains ROG related videos.

The Utilities menu shows the applications and other software that the motherboard supports.

Click an item to install

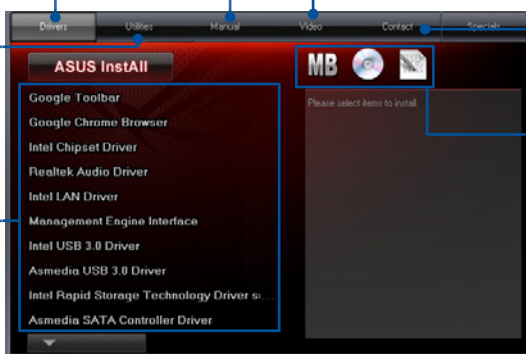

Click the Contact tab to display the ASUS contact information.

Click an icon to display DVD/motherboard information

4.2.2 Obtaining the software manuals

The software manuals are included in the support DVD. Follow the instructions below to get the necessary software manuals.



The software manual files are in Portable Document Format (PDF). Install the Adobe® Acrobat® Reader from the **Utilities** tab before opening the files.

To read about your motherboard's utility guide:

1. Click **Manual** tab > **ASUS Motherboard Utility Guide**.



2. From the **Manual** folder, open the folder of the software manual that you wish to read.

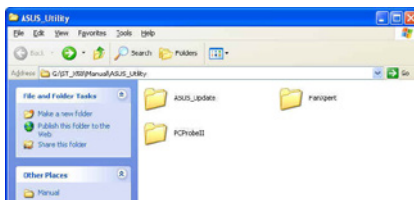

3. Some software manuals are provided in different languages. Open the language's folder to view the software manual.

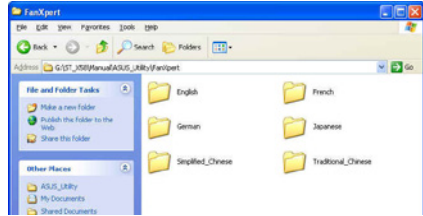

The screenshots in this section are for reference only. The actual software manuals containing in the support DVD vary by models.

4.3 Software information

Most of the applications in the support DVD have wizards that will conveniently guide you through the installation. View the online help or readme file that came with the software application for more information.

4.4 AI Suite 3

AI Suite 3 is an all-in-one interface that integrates several ASUS utilities and allows you to launch and operate these utilities simultaneously.

Installing AI Suite 3



- Ensure that you have an Administrator account before installing AI Suite 3 in Windows® 7 or Windows® 8 OS.
- To install the Wi-Fi-enabled features of AI Suite 3, ensure that you install the Wi-Fi module driver from the bundled support DVD. To do this, go to **Drivers** tab > **ASUS Bluetooth 4.0 Wi-Fi Driver** and follow the succeeding onscreen instructions.

To install AI Suite 3 on your computer:

Windows® 7 OS

1. Place the Support DVD into the optical drive.
2. In the **AutoPlay** dialog box, click **Run ASSETUP.exe** then select the **Utilities** tab

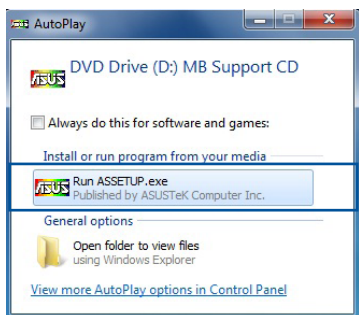

3. From the **Utilities** tab, click **AI Suite 3** then follow the succeeding onscreen instructions.

Windows® 8 OS

1. Place the Support DVD into the optical drive then follow onscreen instructions.
2. From the **ASUS motherboard support DVD** main menu, select the **Utilities** tab and click **AI Suite 3**.
3. Follow the succeeding onscreen instructions.

If the **ASUS motherboard support DVD** main menu did not appear, try the following steps:

- a. Go to the **Start Screen** then click or tap the **Desktop** app.
- b. On the lower left corner of the Desktop, click or tap **File Explorer**  then select your DVD drive and tap or double-click the **Setup** application.

Launching AI Suite 3

Windows® 7 OS

From the Desktop, click **Start > All Programs > ASUS > AI Suite 3 > AI Suite 3**.

You can also launch AI Suite 3 in Windows® 7 by clicking  on the Notification area.

Windows® 8 OS

To launch AI Suite 3 in Windows® 8, tap the **AI Suite 3** app on the Start Screen (or if you're using a mouse, click the **AI Suite 3** app on the Start screen).

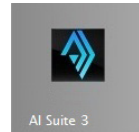

AI Suite 3 Main menu

The AI Suite 3 main menu gives you easy-access controls and insight to what's going on with your computer - allowing you to optimize performance settings while at the same time ensuring system stability.

The AI Suite main menu includes a quick-access menu bar that allows you to swiftly launch any of the integrated ASUS utilities. Click or tap  on the top-right corner of the menu to launch the menu bar.



The AI Suite 3 screenshots in this section are for reference only and can vary depending on motherboard model..

Click to launch AI Suite 3 menu bar

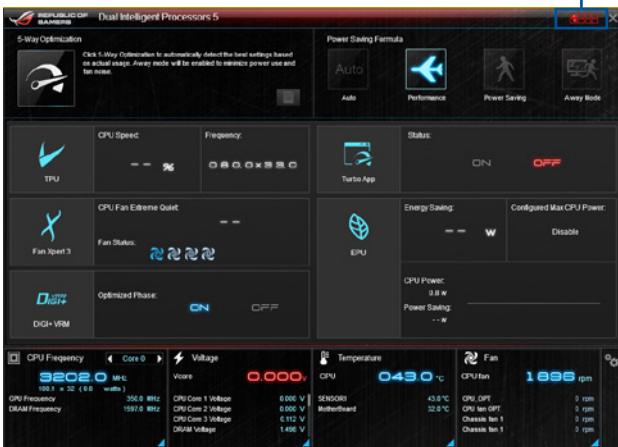

AI Suite 3 main menu bar

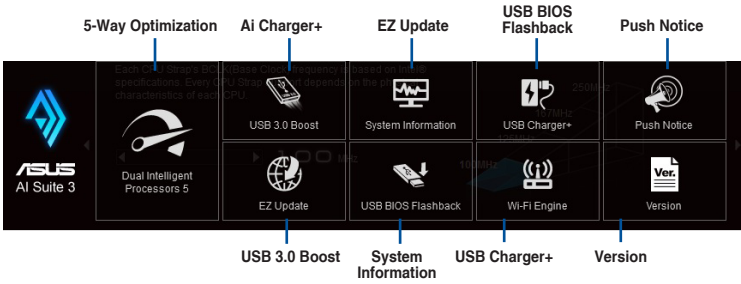

- Some functions in the AI Suite 3 main menu in this user guide may vary depending on the motherboard model.
- Refer to the software manual in the support DVD or visit the ASUS website at www.asus.com for detailed software configuration.

4.4.1 Dual Intelligent Processors 5

ASUS Dual Intelligent Processors 5 combines TPU, EPU, DIGI+ Power Control, Fan Xpert 2, and Turbo App functions to push the system's performance to its optimal potential. It automatically balances the system's performance, power saving, levels, and fan settings via the user-friendly AI Suite 3 utility.

5-Way Optimization

The 5-Way Optimization function dynamically optimizes your computer based on real-time usage to provide the best system status. It covers the essential areas such as CPU performance, energy saving, stable digital power, cool and quiet fan control, and includes tailored settings for your apps to ensure your computer is ready for gaming, entertainment, productivity, or just about anything.

5-Way Optimization screen

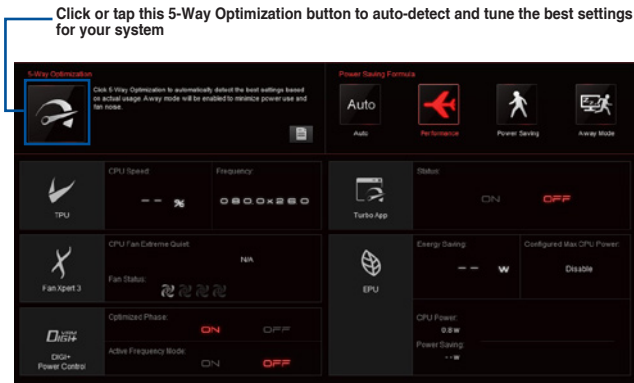

DO NOT remove your fan during the tuning process.

Using 5-Way Optimization

Click or tap the 5-Way Optimization button then click or tap **Start** to auto-detect the best settings based on actual usage.

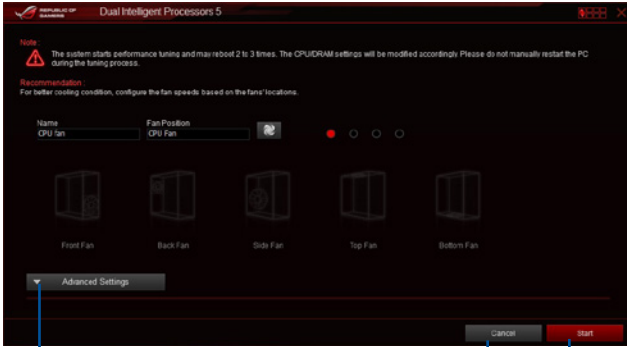

Click or tap to view more settings

Click or tap to go back to the 4-Way Optimization main screen

Click or tap to start auto-tuning



- The system may reboot two or three times during the auto-tuning process.
- For Windows® 8 OS, click or tap **Desktop** app to monitor the auto-tuning process after every system reboot.

TurboV Processing Unit (TPU)

TPU allows you to manually adjust the CPU frequency, CPU cache, core frequencies, DRAM frequency, and related voltages for an enhanced system stability and a performance boost.



Refer to the CPU documentation before adjusting CPU voltage settings. Setting a high voltage may damage the CPU permanently and setting a low voltage may lead to an unstable system.



For system stability, the TPU settings are not saved in the BIOS and are not loaded during system bootup. Save your overclocking settings as a TPU profile and manually load this profile after system bootup.

Using TPU

CPU Frequency

Click or tap ◀ or ▶ to adjust the Base Clock Frequency, CPU Ratio, and CPU Cache Ratio

Click or tap ◀ or ▶ to select the number of cores to adjust

Tick to enable Group Tuning

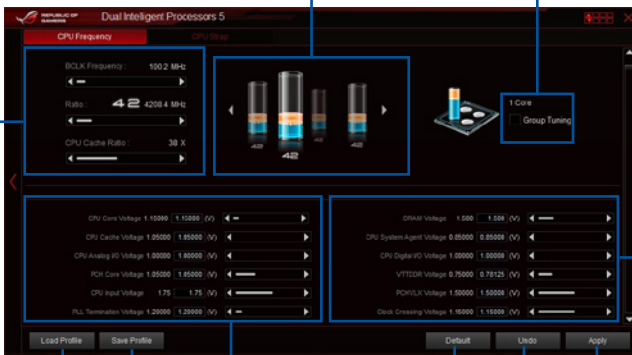

Scroll down to view other items

CPU Cache Voltage adjustments

Click or tap to load the saved profile

Click or tap to save the adjustment into a profile

CPU Core Voltage adjustments

Click to load the default values

Click or tap to undo the adjustments

Click or tap to apply the adjustments



- Set the CPU Ratio Setting item in BIOS to **[Auto]** before using the CPU Frequency in TPU. Refer to the **BIOS** chapter of your motherboard's user guide for details.
- The CPU Frequency bars show the status of the CPU cores, which vary with your CPU model.

CPU Strap

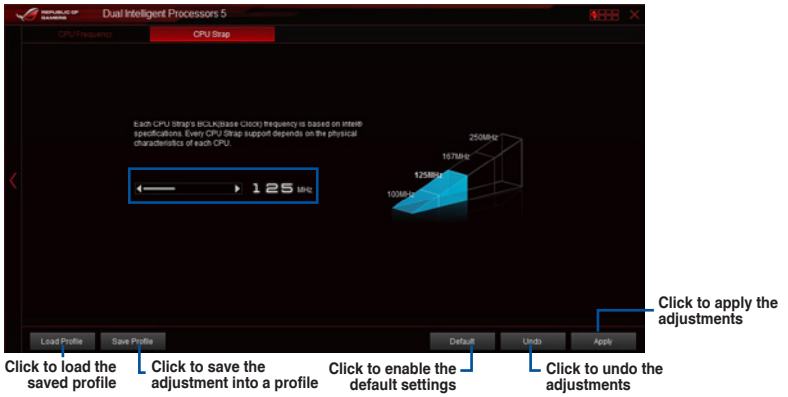

- The overclocking result varies with the CPU model and the system configuration.
- We recommend that you set up a better thermal environment to prevent overheating from damaging the motherboard.

Energy Processing Unit (EPU)

EPU is an energy-processing utility that allows you to adjust the CPU, GPU, and Fan Control settings to their power-saving conditions.

Using EPU

Auto

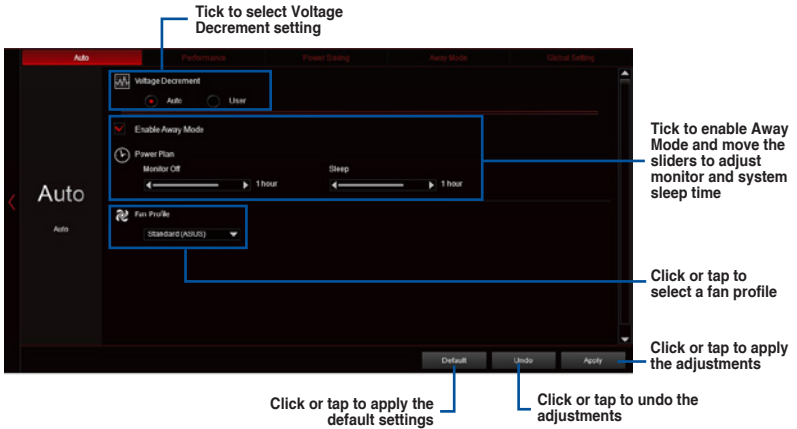

Performance

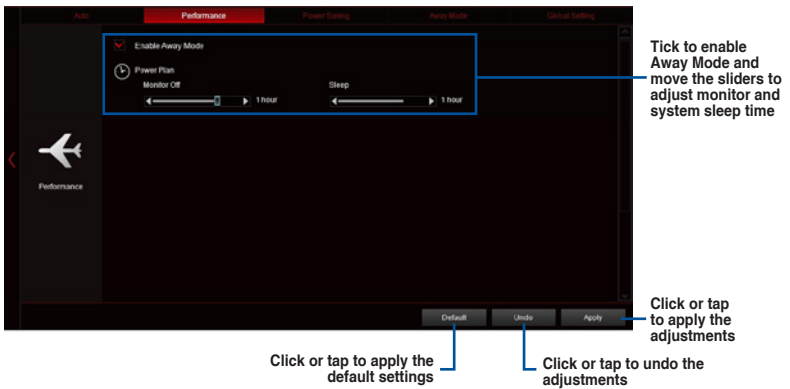

Power Saving

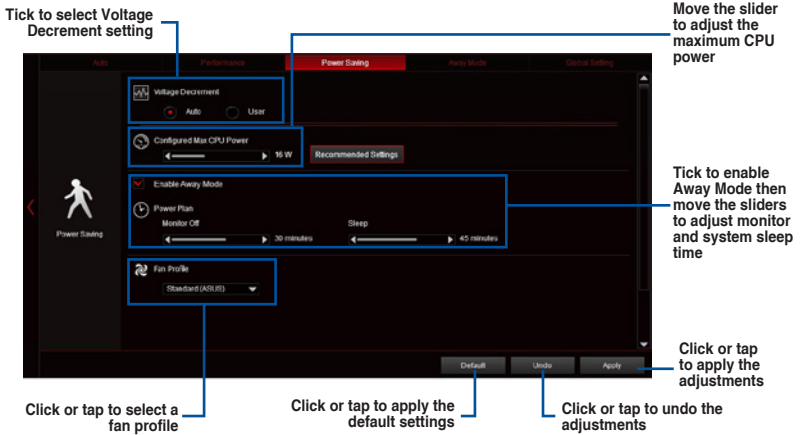

- When you enable the Configured Max CPU Power to boost the energy saving condition, the CPU frequency is displayed at 800 MHz in the Windows® OS information of your computer. However, the actual CPU frequency varies depending on the wattage that you manually set. You can adjust the CPU wattage from the lowest point to your preferred value.
- Configured Max CPU Power may decrease the total power delivery to the CPU and affects the CPU performance under a heavy system. To restore your system to its default settings, reboot your computer.

Away Mode

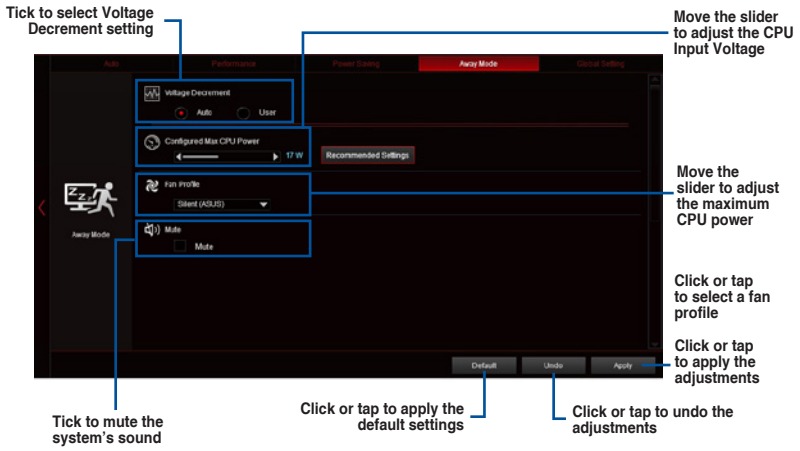

DIGI+ Power Control

DIGI+ Power Control utility allows you to adjust the CPU and DRAM power settings for optimal system efficiency, and overall system stability and performance.

Adjusting the CPU Power

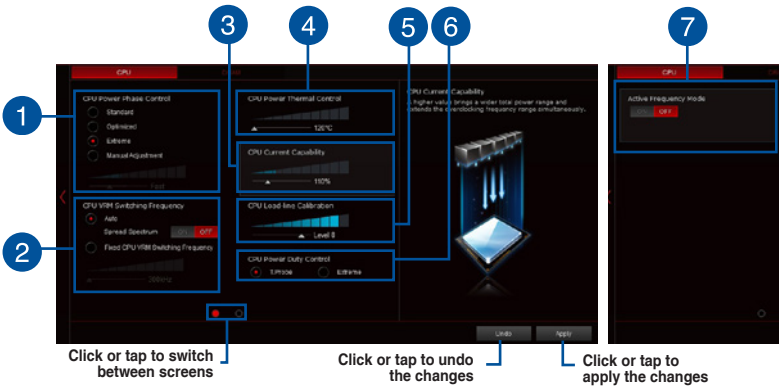

- 1 CPU Power Phase Control**

Increase the phase number under a heavy system load to get more transient and better thermal performance. Reduce the phase number under a light system load to increase the VRM efficiency.

* The system automatically sets the default to [Extreme] when using the Intel® iGPU.
- 2 CPU VRM Switching Frequency**

Enables spread spectrum to enhance system stability.
- 3 CPU Current Capability**

CPU Current Capability provides a wider total power range for overclocking. A higher value brings a wider total power range and extends the overclocking frequency range simultaneously.
- 4 CPU Power Thermal Control**

A higher temperature brings a wider CPU power thermal range and extends the overclocking tolerance to enlarge the overclocking potential.
- 5 CPU Load-line Calibration**

It allows you to adjust the voltage range to control the CPU Load-line. Adjust to a high value for system performance or to a low value for power efficiency.
- 6 CPU Power Duty Control**

CPU Power Duty Control adjusts the current of every VRM phase and the thermal conditions of every phase component.
- 7 Active Frequency Mode**

Active Frequency Mode allows you to enhance the power saving condition of the CPU. Tick ON to get a quicker transient response while saving the CPU power.

Adjusting the DRAM Power

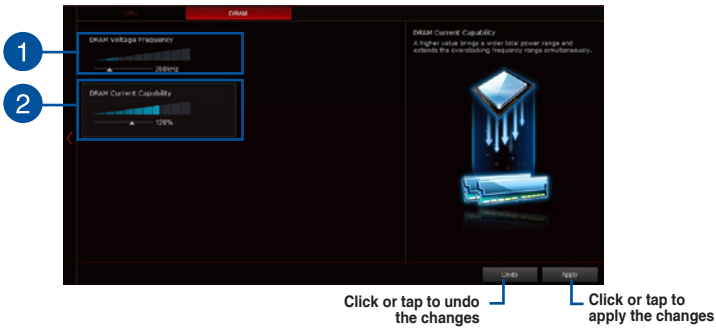

1 DRAM Voltage Frequency
Allows you to adjust the DRAM switching frequency to stabilize the system or to increase the overclocking range.

2 DRAM Current Capability
A higher value brings a wider total power range and extends the overclocking frequency range simultaneously.



- The actual performance boost may vary depending on your CPU specification.
- Ensure that the cooling modules are properly installed in your motherboard to monitor the thermal conditions.

Fan Xpert 2

Fan Xpert 2 automatically detects and tweaks the fan speeds and provides you with optimized fan settings based on the fans' specifications and positions.

Using Fan Xpert 2

Click or tap to set the fan's speed to silent mode

Select a screen to select the type of fan that you want to customize

Click or tap to increase the fan's speed for a high cooling capability

Click or tap to maximize the fan speed

Click or tap to auto-tune the fans to their best settings

Click or tap to set the balanced configuration between the fan's noise level and speed

Click or tap to switch between fan screens

Click or tap to load a profile

Click or tap to save the settings into a profile



DO NOT remove your fan during the Fan Auto Tuning process.

Customizing the fan settings

Smart Mode

Smart Mode allows you to customize the fans' rotation speeds and responses based on your system's temperature.

Click and drag to set the fan's rotation speed

Click and drag the sliders to adjust the fan's response

Click or tap to go back to the previous screen

Click or tap to switch between the CPU and chassis fan screens

Click or tap to undo the changes

Click or tap to apply the changes

RPM Mode

RPM Mode allows you to set the fan speed at its fixed value when the CPU temperature drops 75°C and below.

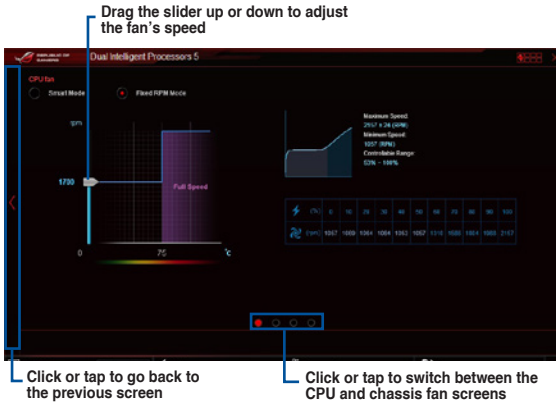

- When the CPU temperature reaches 75° C, the fan automatically runs at full speed to protect the CPU.
- Fan Xpert 2 may not be able to detect the fan speed if you install the fan with an external control kit for rotation speed.
- Fan Xpert 2 only supports fans with 4-pin and 3-pin connectors. If you install a 2-pin fan, it can only run at its full speed.
- If you change the CPU or chassis fans, you must repeat the Fan Auto Tuning process.

Turbo App

Turbo App allows you customize the system performance, network priority, and audio setting of an application.

When an application is on the Turbo App List, you can allocate the CPU frequency, assign a network priority, and define the audio setting of the selected application.

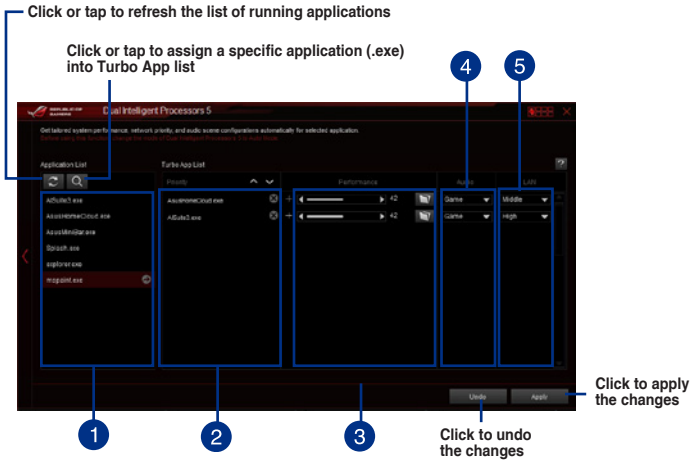

- 1 Applications list pane**
Displays all the running applications on your system.
- 2 Turbo App List pane**
Displays the applications added to the Turbo App List.

* Only applications on the Turbo App List can be configured.
- 3 Performance pane**
Allows you to assign the CPU performance to a selected application.
- 4 Audio pane**
Allows you to manually assign a preset audio configuration to a selected application.
- 5 LAN pane**
Allows you assign the network priority to a selected application.

4.4.2 USB 3.0 Boost

USB 3.0 Boost technology supports UASP (USB Attached SCSI Protocol) that automatically speeds up the transfer rates of your USB storage devices.

Launching USB 3.0 Boost

To launch USB 3.0 Boost, click or tap the  on the top-right corner of the AI Suite 3 main menu, then select **USB 3.0 Boost**.

Using the USB 3.0 Boost

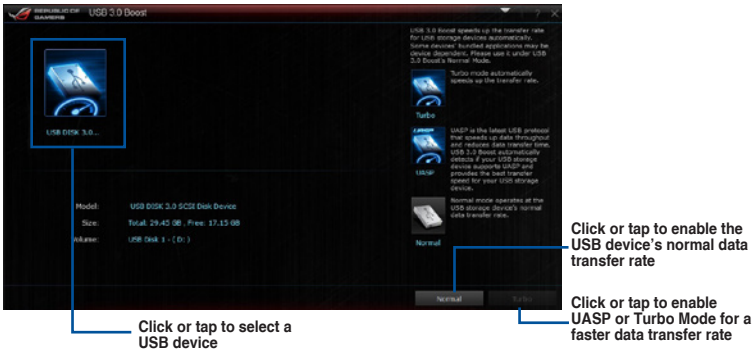

Ensure to connect your USB 3.0 device to the USB 3.0 ports that support USB 3.0 Boost. Refer to section **2.3.1 Rear I/O connection** for more details.



- USB 3.0 Boost automatically detects the USB 3.0 devices that support UASP. For a list of UASP-supported USB 3.0 devices, visit the ASUS website at www.asus.com.
- The data transfer speed varies with USB devices. For a higher data transfer performance, use a USB 3.0 device.

4.4.3 USB BIOS Flashback

USB BIOS Flashback allows you to check and save the latest BIOS version to a USB storage device. Use this utility to quickly check for the latest available BIOS and set the BIOS download schedule.

Launching USB BIOS Flashback

To launch USB BIOS Flashback, click or tap the  on the top-right corner of the AI Suite 3 main menu, then select **USB BIOS Flashback**.



USB BIOS Flashback is available only in selected motherboard models.

Using USB BIOS Flashback

Set a schedule for the BIOS Update download



Click or tap to cancel the download schedule setting

Click or tap to apply the download schedule setting

Click or tap to check for a new BIOS update available for download

Scheduling the BIOS download

1. In the Download Setting field, tick **Schedule (days)** then select the number of days for the BIOS download schedule.
2. Click or tap **Apply** to save the BIOS download schedule. Click or tap **Cancel** to cancel the download schedule.

Downloading the latest BIOS



Before you start downloading, ensure that you have installed the USB storage device to your computer's USB port that supports USB BIOS Flashback. Refer to section **2.3.1 Rear I/O connection** of your user manual for more details.

To download the updated BIOS:

1. From the USB BIOS Flashback screen, click or tap **Check for New BIOS Update**.

Wait for the system to check the latest BIOS version.

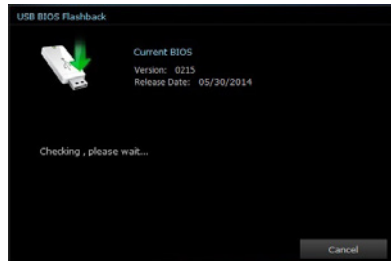

2. After the utility detects a new BIOS, click or tap **Save to:** field, select the USB flash drive, then click or tap **Download**.

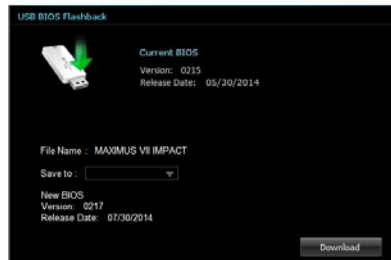

3. After the download is complete, click or tap **OK**.

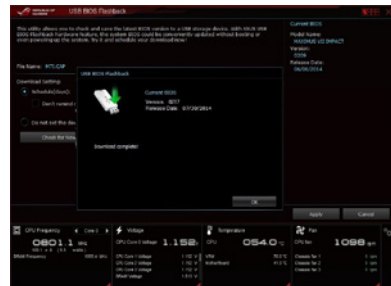

4.4.4 USB Charger+

USB Charger+ allows you to quick-charge your portable USB devices even if your computer is off, in sleep mode or hibernate mode.



Before using USB Charger+, ensure to disable the ErP Ready item in the BIOS. To do this, go to **Advanced > APM > ErP Ready** in the Advanced mode then set this item to [Disabled].



USB Charger+ is available only in selected motherboard models.

Launching USB Charger+

To launch USB Charger+, click or tap the  on the top-right corner of the AI Suite 3 main menu, then select **USB Charger+**.

Using USB Charger+

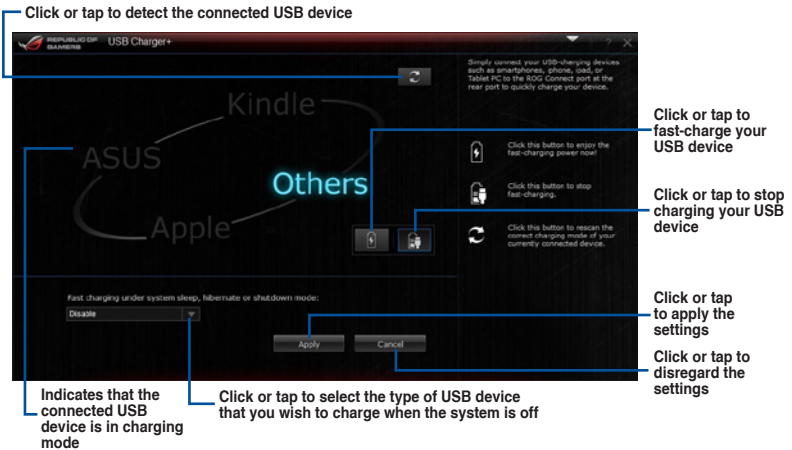

The screenshot shows the USB Charger+ utility window. It features a dark background with logos for Kindle, ASUS, Apple, and Others. A central area contains three icons: a power button, a USB device, and a refresh button. Below these icons are three callouts: 'Click this button to enjoy the fast-charging power now!', 'Click this button to stop fast-charging', and 'Click this button to reselect the correct charging mode of your currently connected device'. At the bottom, there is a dropdown menu for 'Fast charging under system sleep, hibernate or shutdown mode' set to 'Disable', and 'Apply' and 'Cancel' buttons. Callouts point to these elements with the following text:

- Click or tap to detect the connected USB device
- Click or tap to fast-charge your USB device
- Click or tap to stop charging your USB device
- Click or tap to reselect the correct charging mode of your currently connected device
- Click or tap to apply the settings
- Click or tap to disregard the settings
- Indicates that the connected USB device is in charging mode
- Click or tap to select the type of USB device that you wish to charge when the system is off



Ensure to connect your USB device into the USB port that supports this utility. Refer to section **2.3.1 Rear I/O connection** of your user manual for more details.



- USB Charger+ does not support USB hubs, USB extension cables, and generic USB cables.
- USB Charger+ may not recognize some ASUS devices due to varying design.

4.4.5 Wi-Fi Engine

Wi-Fi Engine allows you to connect to a wireless network and set up your computer as an access point for Internet connection sharing among Wi-Fi enabled devices.

To use Wi-Fi Engine, click or tap the **Wi-Fi Engine** on the top-right corner of the AI Suite 3 main menu, then select **Wi-Fi Engine**.



Wi-Fi Engine is available only in selected motherboard models.

Using Wi-Fi Engine

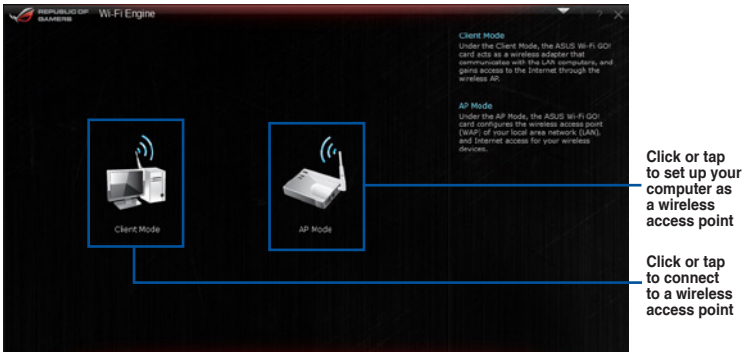

Using the Client Mode

The Client mode allows you to connect your system to a wireless network.

To use the client mode:

1. Click or tap **Client Mode** to launch Network Connections.
2. From the Network Connections window, select a network adapter.

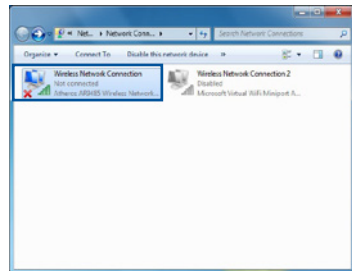

- From the list of available networks, select a network that you want to connect to.



Some networks may require you to key in a password.

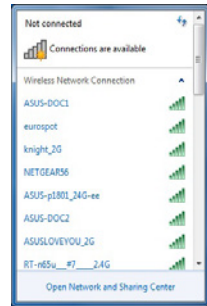

Using the AP Mode

The AP mode allows you to set your system as an access point for other wireless-enabled devices.

To use AP mode, click or tap **AP Mode** on the Wi-Fi Engine menu.

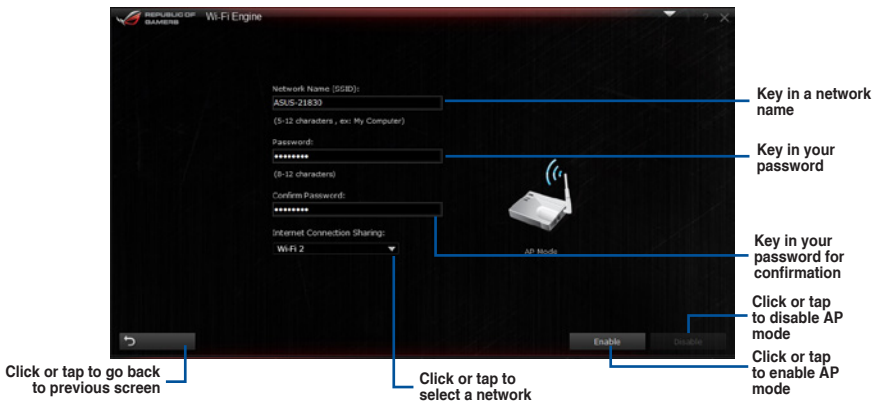

4.4.6 EZ Update

EZ Update is a utility that allows you to automatically update your motherboard's softwares, drivers and the BIOS version easily.

With this utility, you can also manually update the BIOS and select the boot logo that will display during POST.

Launching EZ Update

To launch EZ Update, click or tap the  on the top-right corner of the AI Suite 3 main menu, then select **EZ Update**.

Using EZ Update

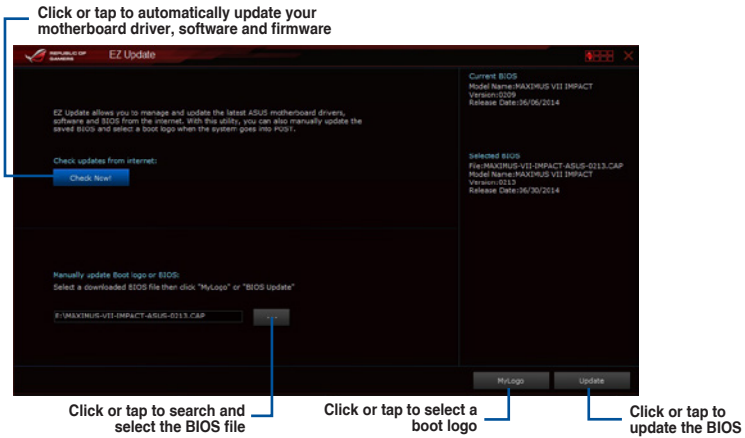

Manually update the BIOS and selecting a boot logo

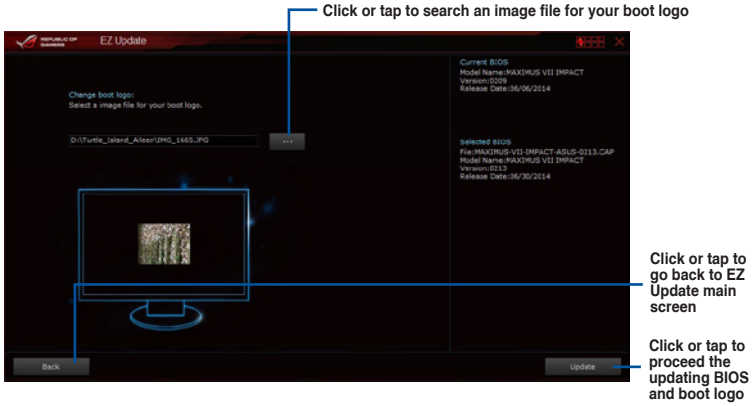

After you click or tap **BIOS Update** button, click or tap **Flash** to update the BIOS and upload the boot logo in your system.

4.4.7 Push Notice

This utility allows you get the detailed status of your system to your smart device. You can also send messages to your smart device using this utility.





Before using this utility, ensure that you pair your computer with your smart device. For pairing information, refer to section **Pairing your computer and smart device**.

Launching Push Notice on your computer

To launch Push Notice, click or tap  on the top-right corner of the AI Suite 3 main menu, then select **Push Notice**.

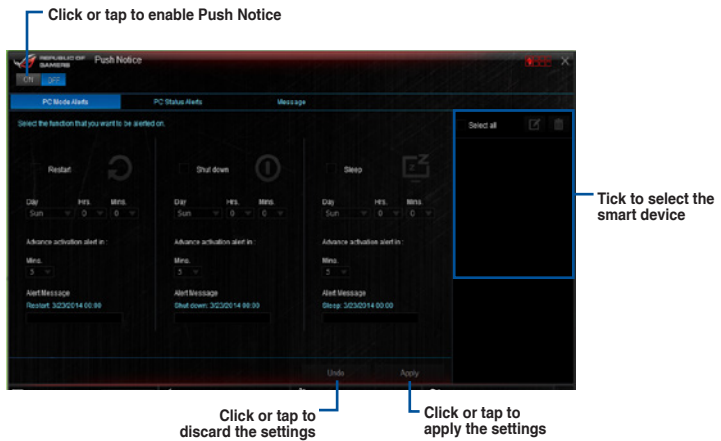
Push Notice screen



You can also enable the Push Notice via the Push Notice shortcut on the lower-right corner of your screen. To do this, click or tap << then click or tap , then select .

Pairing your computer and smart device

To pair your computer and smart device:

1. On your smart device, tap  to launch Push Notice.
2. Tap **Push Scan** then tap the name of your computer that you want to pair with.



To pair your computer and smart device, ensure that both are connected to the same wireless network.

Setting up PC Mode alerts of your computer

This feature allows you to restart, shut down, or put your computer to sleep mode and sends an alert to your smart device.

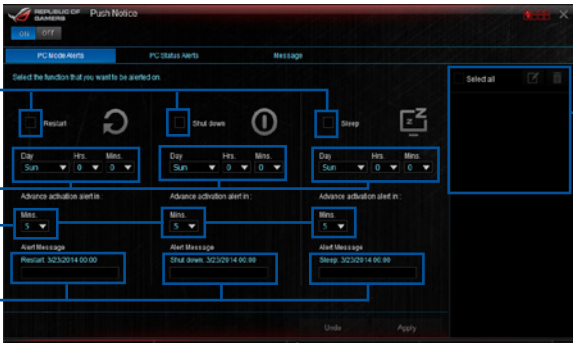

The screenshot shows the 'Push Notice' application interface for configuring 'PC Mode Alerts'. The window title is 'Push Notice' and it has a 'Push Notice' button in the top left. The main area is titled 'PC Mode Alerts' and contains three columns of settings for 'Restart', 'Shut down', and 'Sleep'. Each column has a 'Selected' checkbox, a 'Day' dropdown (set to 'Sun'), and 'Hrs' and 'Mins' dropdowns (both set to '0'). Below these are 'Advance activation alerts' and 'Advance inhibition alert in' sections, each with a 'Mins' dropdown (set to '5') and an 'Alert Message' text box. The 'Alert Message' boxes contain: 'Restart: 3/23/2014 00:00', 'Shut down: 3/23/2014 00:00', and 'Sleep: 3/23/2014 00:00'. On the right side, there is a 'Message' area with a 'Selected all' button. At the bottom, there are 'Undo' and 'Apply' buttons. Blue lines and boxes highlight the 'Selected' checkboxes, the 'Day', 'Hrs', and 'Mins' dropdowns, the 'Alert Message' text boxes, and the 'Selected all' button.

Tick these to enable mode alerts

Set the day and time to enable the PC modes

Set the minutes to send the alert before the PC mode/s activation

Key in your messages for more information

Tick to select the smart device

Setting up PC Status alerts

This feature allows you to send alerts of the unusual activities of the voltage, temperature, and fan settings of your computer to your smart device.

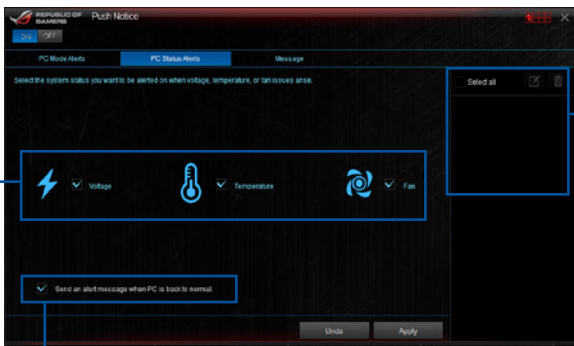

The screenshot shows the 'Push Notice' application interface for configuring 'PC Status Alerts'. The window title is 'Push Notice' and it has a 'Push Notice' button in the top left. The main area is titled 'PC Status Alerts' and contains three columns of settings for 'Voltage', 'Temperature', and 'Fan'. Each column has a 'Selected' checkbox and a 'Send an alert message when PC is back to normal' checkbox. Below these are 'Undo' and 'Apply' buttons. On the right side, there is a 'Message' area with a 'Selected all' button. Blue lines and boxes highlight the 'Selected' checkboxes, the 'Send an alert message when PC is back to normal' checkbox, and the 'Selected all' button.

Tick to select and send alerts to your smart device



Tick to send alert when the selected items are back to its normal status

Tick to select the smart device

Sending messages to your smart device

This feature allows you to send messages to your smart device.



You can also send messages via the Push Notice messaging shortcut on the lower-right corner of your screen. To do this, click or tap << then click or tap  then select .

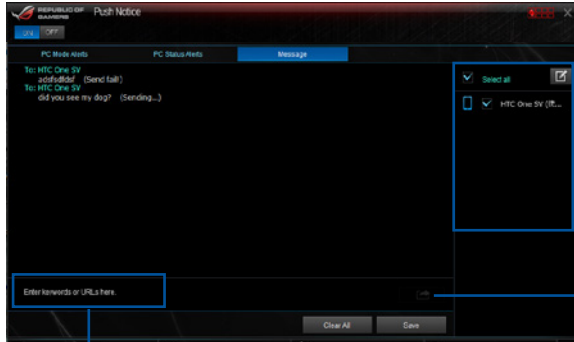

Tick to select the smart device

Click or tap to send your message

Click or tap to key in your message

Viewing your computer status on your smart device

Tap  on your smart device to launch Push Notice.

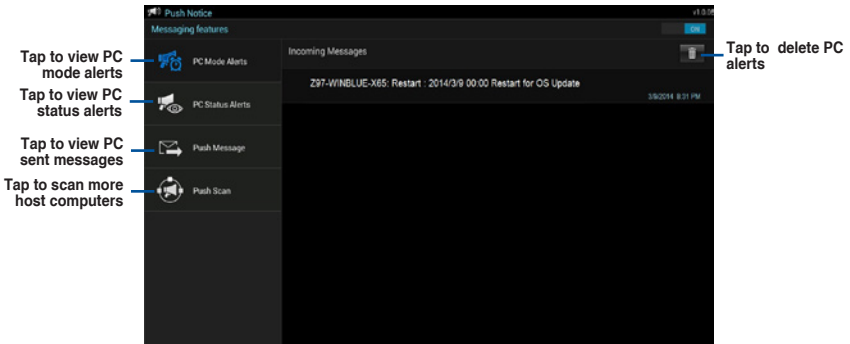

Tap to view PC mode alerts

Tap to view PC status alerts

Tap to view PC sent messages

Tap to scan more host computers

Tap to delete PC alerts

4.4.8 System Information

This utility allows you get the detailed information of the motherboard, CPU, and memory settings.

Launching the System Information

To launch System Information, click or tap the  on the top-right corner of the menu to launch the menu bar., then select System Information.

Viewing the motherboard information

Click or tap the **MB** tab to view the motherboard's information.

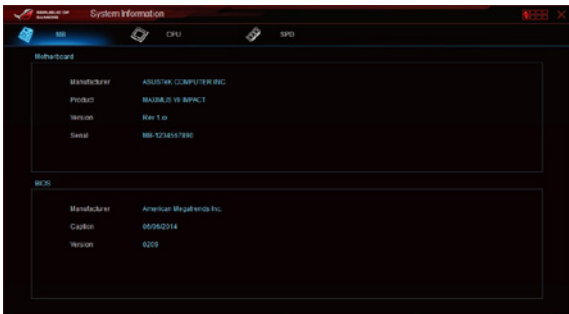

Viewing the CPU information

Click or tap the **CPU** tab to view the processor's information.



Viewing the SPD information

Click or tap the **SPD** tab to view the memory's information.



4.5 Wi-Fi GO!

Wi-Fi GO! is ASUS-exclusive Wi-Fi utility that allows you to wirelessly stream your media files to wireless devices, control your computer using your smart device, transfer files to your smart device, and provides access to your files stored in your cloud storage.



- To use Wi-Fi GO! functions across different networks, log into your ASUS account on your computer and smart device.
- The screenshots used in this section are for reference only and can appear from the actual software you are using. Refer to the ASUS Support site at <http://support.asus.com> for updated documentations on this motherboard.



The user interface of your smart device may vary with the operating system and the screen resolution.

Wi-Fi GO! System requirements

System requirements	Computer	Smart device
OS	Windows® 7/Windows® 8	Android 2.3 or higher versions iOS5 or later versions
Utilities	ASUS AI Suite 3	ASUS Wi-Fi GO! & NFC Remote



- For Android devices, download the ASUS Wi-Fi GO! & NFC Remote from Google Play. For iOS devices, download it from App Store.
- Install the Wi-Fi GO! card driver and ASUS HomeCloud utility from the support DVD bundled with your ASUS motherboard or visit www.asus.com.
- If you upgrade from Windows® 8 to Windows® 8.1, ensure to reinstall the Wi-Fi GO! card driver to fully utilize the Wi-Fi GO! functions.

Smart device supported screen resolutions

Wi-Fi GO! & NFC Remote supports the following screen resolutions of smart devices:

Screen type	Low density (120 ldpi)	Medium density (160 mdpi)	High density (240 hdpi)	Extra high density (320 xhdpi)
Screen Resolution	1024 x 600	WXGA (1280 x 800)	1536 x 1152	2048 x 1536
		1024 x 768	1920 x 1152	2560 x 1536
		1280 x 768	1920 x 1200	2560 x 1600

4.5.1 Signing in to your ASUS Account

Wi-Fi GO! gives you complete control of your computer anytime and anywhere. Create and login the same ASUS Account on your computer and smart devices for public-to-private network functions.



Remote Desktop and File Transfer support public-to-private networks feature.

Creating an ASUS account



Ensure that you have an internet connection before you create an account.

To create a new ASUS Account:

1. Launch ASUS HomeCloud then click or tap .
2. From the Wi-Fi GO! screen, click or tap  > **Create a New Account**. The browser then directs you to the ASUS website at www.asus.com.
3. From the ASUS website, click or tap **Sign Up Now!** then follow onscreen instructions to complete the registration.

Logging in to your ASUS account

To log-in using your computer:

1. Launch ASUS HomeCloud then click or tap .



A login notice is displayed when you launch Wi-Fi GO! for the first time on your computer. To stop this notice from appearing again, tick **Don't remind me again** then click or tap **Go to Login**.

2. From the log-in window, key in your ASUS account and password (A) then click **Login** (B).

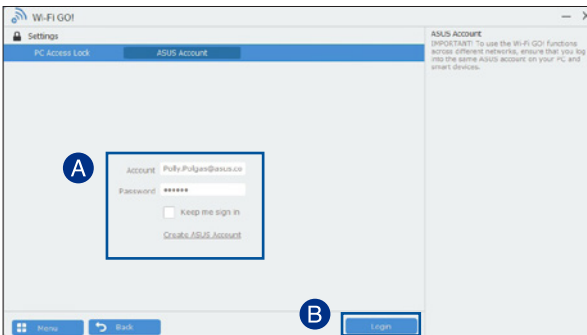

To log-in using your smart device:

1. Launch  on your smart device then tap **Enter**.
2. From Wi-Fi GO! and NFC Remote screen, tap **ASUS Account (A)**, key in your ASUS Account and password, then click or tap **Login (C)**.

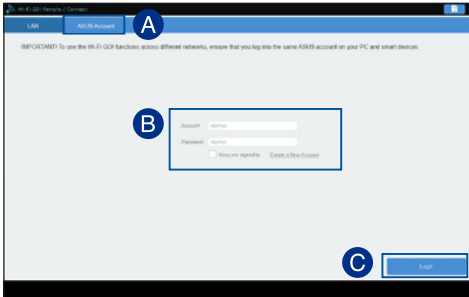

- The systems with the same ASUS account logged in will show up in the device list.
- The public-to-private network functions for the iOS system will be available from **Wi-Fi GO! & NFC Remote V2.00.00** or later versions.

4.5.2 Using Wi-Fi GO!

From your desktop, launch **ASUS HomeCloud** then click or tap .

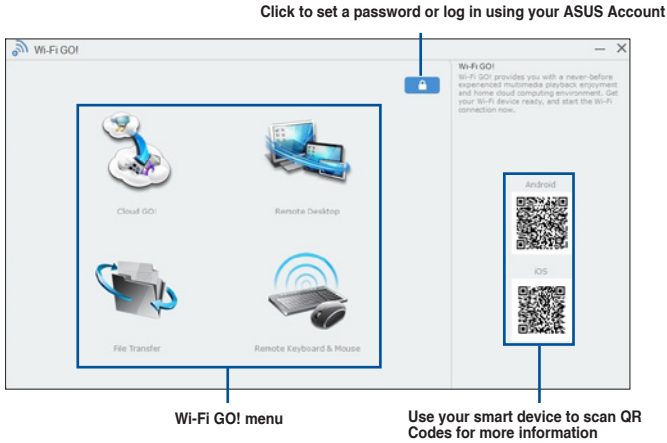

To protect your Wi-Fi GO! utility from unauthorized remote access, click  then set a password.



Launch Wi-Fi GO! & NFC Remote on your smart device to use the Wi-Fi GO! & NFC remote control functions. For more details, refer to section **Wi-Fi GO! & NFC Remote (App for smart devices)** of this user manual for more details.

Wi-Fi GO! & NFC Remote (App for smart devices)

Using Wi-Fi GO! & NFC Remote

To use the Wi-Fi GO! & NFC Remote:

1. Launch  on your smart device then tap **Enter**.
2. Connect your smart device with your computer. You can do this in two ways:
 - a. To connect to the same network, tap **LAN**.
 - b. To connect using your ASUS account, tap **ASUS account** then key in your user name and password and tap **Login**.



When you connect your smart device to your computer using your ASUS account, you can only use Remote Desktop and File Transfer features.

3. From the list of scanned computers, tap to select the computer that you want to connect with your smart device.

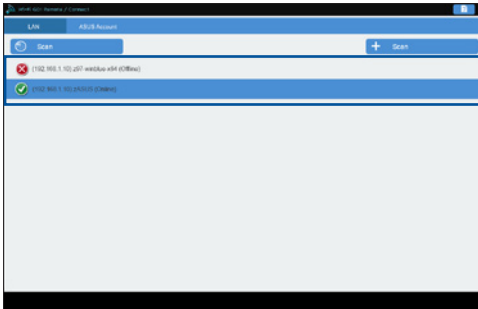

When done, the Wi-Fi GO! & NFC Remote interface appears on your smart device.

Wi-Fi GO! & NFC Remote interface main page

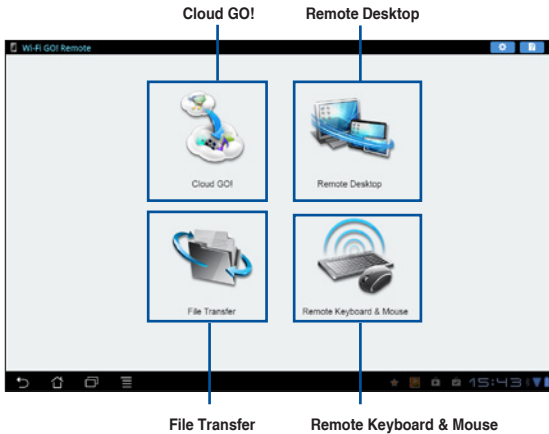

The screenshots are for reference only and vary with the type of smart device.

Using the Wake-on-LAN

If you want to wake up your computer using the smart device, ensure that you enable the computer's Wake-on-LAN settings.

To configure your computer's Wake-on-LAN settings:

1. From BIOS Setup, go to **Advanced > APM Configuration** then set **Power On By PCI-E/PCI** item to **[Enabled]**.
2. From Windows® OS, do the following:
 - a. On your desktop, click **Start**, right-click **Computer > Manage** to launch the Computer Management screen.
 - b. Click **Device Manager** to view all the installed devices.
 - c. Click **Network Adapters**, right-click the installed module card (Broadcom or Atheros) then click **Properties > Power Management** tab.
 - d. Tick these items **Allow this device to wake up the computer** and **Only allow a magic packet to wake the computer**.



For 802.11ac standard Wi-Fi GO! Card, the Wake-on-LAN function will be supported in the later version for Windows® 8 operating system.

Cloud GO!

Cloud GO! allows you to control and synchronize your files across multiple cloud services such as ASUS WebStorage, Dropbox®, Google Drive™, and SkyDrive®.



- Ensure to set the correct system date and time of your computer and smart device when using Cloud GO!
- Due to the cloud storage limitation, you can only upload or synchronize files with a maximum size of 100 MB.
- The synchronized files will be saved under the Wi-Fi GO! folder of each cloud storage. For the backed up files, you can find them in **C://MyFavorites** folder.
- Log into the cloud storages accounts first in your computer and stay signed in to allow smart device control.

To use Cloud GO!:

1. From the Wi-Fi GO! screen, click or tap **Cloud GO!**
2. Tick EULA box then click or tap **Enter**.
3. Log in to your cloud account then click or tap **Sign In**.



To log in to your Google Drive™, Dropbox®, or SkyDrive® accounts, click or tap **Sign in**. Cloud GO! directs you to the Google Drive™, Dropbox®, or SkyDrive® website to log in to your account.

Click or tap a specific icon to move, upload, rename, create folder, download, delete or refresh your cloud contents

Click or tap to open a cloud storage account

Click or tap to sign out

Click or tap to go back to the previous screen

Click or tap to synchronize cloud contents or to create a back up to your local drive

Click or tap to go back to Wi-Fi GO!/Remote GO! screen

Tick to select contents

File Name	Date	Size
img7.jpg	2013-03-03...	1188.36 KB
img8.jpg	2013-03-03...	691.87 KB
img9.jpg	2013-03-03...	1129.43 KB
Wi-Fi GO!	2013-01-03...	

Remote Desktop

Remote Desktop allows you to remotely control your desktop in real-time using your smart device.



The System User Account Control (UAC) must be set to **Never Notify** when using Remote Desktop function. The UAC level returns to your previous settings after you exit Remote Desktop.

Using Remote Desktop

From the Wi-Fi GO! screen of your smart device, tap **Remote Desktop**.

Remote Desktop interface for Windows® 8



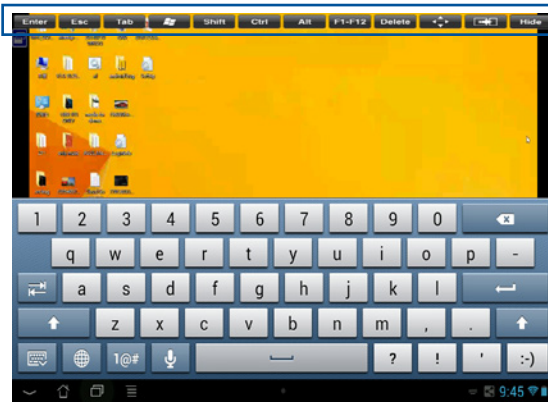

Remote Desktop
function keys



- Select multitouch mode to support Microsoft multitouch functions on Windows® 8 / Windows® 8.1.
- Select mouse mode to support zoom-in and normal mouse functions.
- The Extended Mode support varies with the VGA driver installed in your computer.

Remote Desktop Control Notification

This function allows you to send the control authorization to a smart device and directly start using Remote Desktop in your device.

To use Remote Desktop Control Notification:

1. Click **Select Device**.

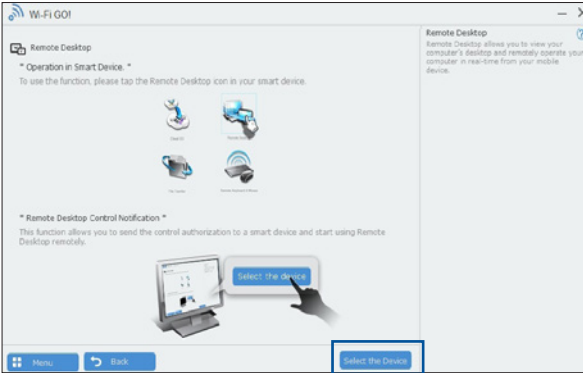

2. Select a device from the drop list.
3. Click **Send** to send the Remote Desktop control authorization to the selected device.

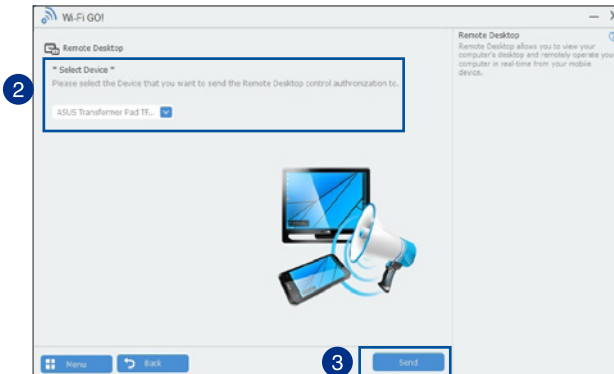

This function requires the **Push Notice** feature to be installed. Install the Ai Suite 3 from the bundled support DVD or download the latest software from www.asus.com.

File Transfer

File Transfer allows you to sync and share files between your computers and smart devices with just a click in public-to-private networks.

Transferring files from computer to smart device

To transfer files from computer to smart device:

1. Click or tap **File Transfer**.
2. Click or tap **Setting** to select the destination for your transferred files.
3. Right-click the file then select **Send to > [Device Name]**.



4. After the file transfer is complete, click or tap **OK**.



- To receive files on your iOS device, go to **Settings > Privacy > Photos** then turn on the Wi-Fi GO! & NFC Remote.
- Find your transferred files from <SD Card>\Wi-Fi GO! for Android devices and Camera roll for iOS devices.

Transferring files from smart device to computer

To transfer files from smart device to computer:

1. Tap **File Transfer > Enter**.
2. Tick the files that you want to send to your computer, then tap **Send**.



Find your transferred files from **X:\Users\Documents\ASUS HomeCloud\Wi-Fi GO!\File Transfer** or click **Setting** to select a new storage location.

Remote Keyboard & Mouse

Remote Keyboard & Mouse allows you to use your smart device's touch panel as a remote keyboard and mouse for your computer.

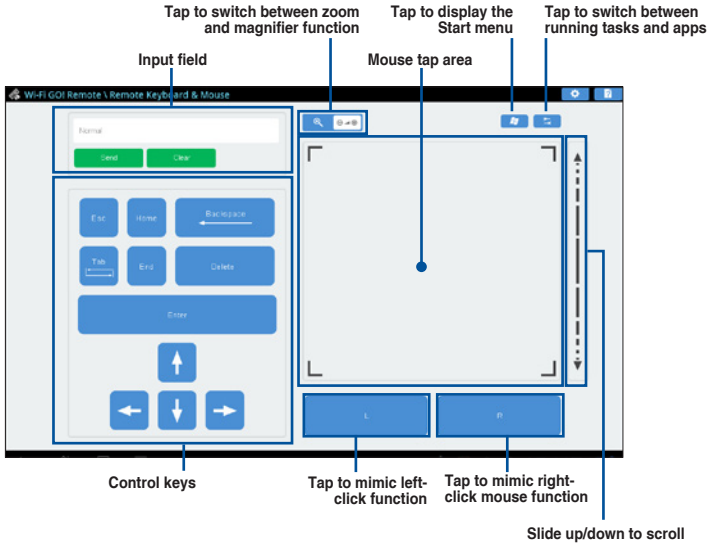

4.6 ASUS Media Streamer

The ASUS Media Streamer allows you to enjoy your multimedia content anywhere. You can pipe music from your computer or stream your favorite movie to a smart TV using your computer or smart device.



- Ensure to enable the DLNA setting of your devices first.
- ASUS Media Streamer supports NFC function. Some functions may require you to install NFC EXPRESS 2. Visit www.asus.com for more information about NFC EXPRESS 2.
- For Android devices, download the ASUS Media Streamer from Google Play. For iOS devices, download it from App Store.



- The public-to-private network functions for the iOS system will be available from Media Streamer V2.00.00 or later versions.
- The iOS system only supports photo and video streaming for Media Streamer.

4.6.1 System requirements

System requirements	Computer	Smart device
OS	Windows® 7/Windows® 8/ Windows® 8.1	Android 4.0 or higher versions iOS7 or later versions
Utilities	ASUS HomeCloud	ASUS Media Streamer

4.6.2 Using ASUS Media Streamer

To use ASUS Media Streamer, launch ASUS HomeCloud from your desktop then click or tap . On your smart device, click or tap **Media Streamer**.

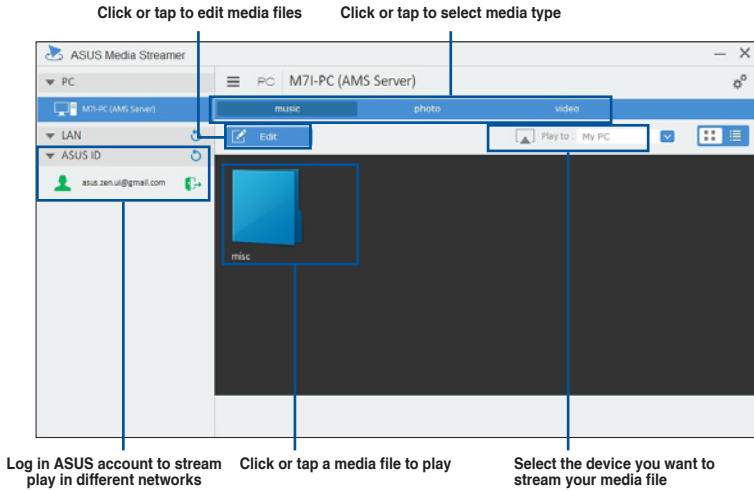

Adding and deleting media files

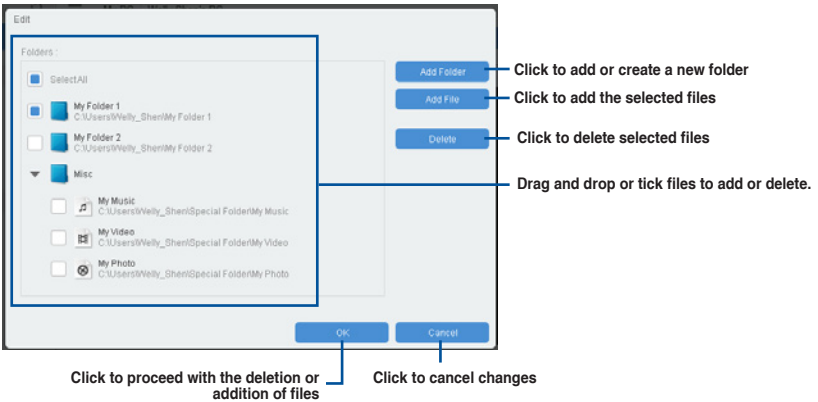

The following media formats are supported by Android and iOS devices:

- **Android:** .3gp, .mp4, .m4a, .aac, .ts, .flac, .mp3, .mid, .xmf, .mxmf, .rtttl, .rtx, .ota, .imy, .ogg, .mkv, .wav, .jpg, .gif, .png, .bmp, .webp, .webm
- **iOS:** .mov, .mp4, .mpv, .3gp.

4.7 ROG Audio features

Installing the Software

Follow the installation wizard to install the Realtek® Audio Manager driver from the support DVD that is bundled with the motherboard.

If the Realtek® audio software is correctly installed, you will find the Realtek® HD Audio Manager icon on the taskbar. Double-click or tap on the icon to display the Realtek® HD Audio Manager.



Realtek® HD Audio Manager

4.7.1 Sonic Studio

Sonic Studio is an audio suite that offers six audio controls: Reverb, Bass Boost, Equalizer, Voice Clarity, Smart EQ (Smart Volume), and Virtual Surround. Virtual Surround is dedicated for 2-channel headset and offers one of the best virtual surround technology for gaming.



The Sonic Studio application does not have its independent installer. It is automatically installed when the Realtek® Audio Driver is installed in your system.

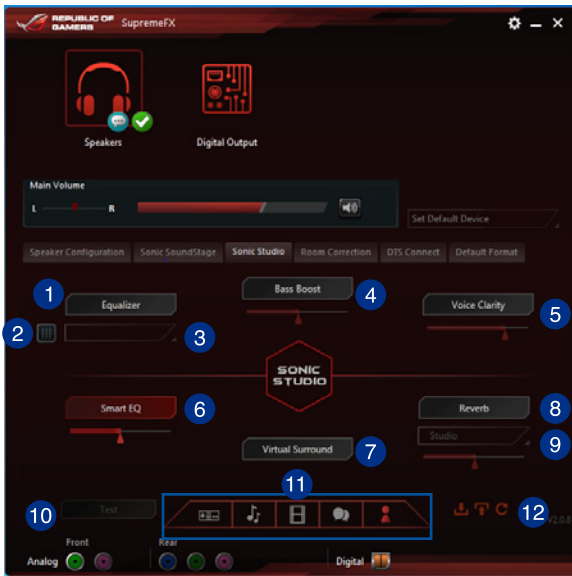

- 1 **Equalizer switch**
Click or tap to enable the equalizer. This item allows you to adjust the parametric EQ settings according to your preference.
- 2 **Equalizer advanced settings**
This item is available only when you enable the Equalizer. This item allows you to configure the Equalizer settings. You can manually set or customize your setting, or choose from any of the available preset equalizer settings.
- 3 **Equalizer presets**
Displays the current or selected equalizer preset.
- 4 **Bass Boost switch**
Click or tap to boost the bass effect. Use the slider to adjust the sound of the bass effect.
- 5 **Voice Clarity switch**
Click or tap to enable this item. Voice clarity extracts human voice for better dialog/audio communication or to hear vocals more clearly when listening to a music.
- 6 **Smart EQ (Smart Volume) switch**
Dynamically adjusts the EQ so you can hear more details.
- 7 **Virtual Surround switch**
This item lets you experience 7.1 CH virtual surround from your headset when enabled.
- 8 **Reverb switch**
The Reverb effect is part of the Virtual Sound Stage effects that lets you choose other reverb presets.
- 9 **Reverb presets**
Click to choice and select a reverb effect from the different environmental spaces for reverb effects. This item is only available when the Reverb switch is enabled.
- 10 **Test tone**
Click this button to start the test for the selected preset profile.
- 11 **Preset profiles**
Click any of the preset profiles. Choose from Gaming, music, movie, or communication.
- 12 **Profile import/export**
Allows you to Import, export, or revert to the default setting of a profile.

4.7.2 Sonic SenseAmp

Sonic SenseAmp is an exclusive ROG invention that is a built-in headphone AMP on onboard audio with three AMP levels adjustment. It detects your headphone's impedance and adjusts the built-in AMP accordingly.



- Sonic SenseAmp only works on the front panel.
- Maximize the volume of your headphone's volume control for an accurate impedance detection.

When you plug a headphone into the front headphone jack, Sonic SenseAmp displays a pop-up window that displays **Detecting headphone impedance**.

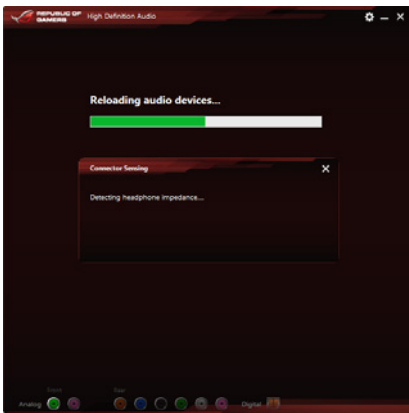

After detecting the headphone's impedance, Sonic SenseAmp displays another pop-up window similar to the one shown below.

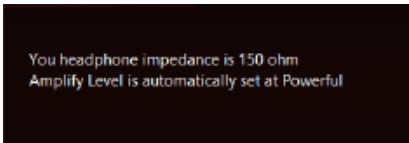

Refer to the table below on the behavior of Sonic SenseAmp when adjusting the impedance of the detected headphone:

65 ohm or below	Amplify Level is automatically set at Performance
65 ohm to 150 ohm	Amplify Level is automatically set at Powerful
> 150 ohm	Amplify Level is automatically set at Extreme
Other device	The device plugged in detected as other device

After you close the pop-window, Sonic SenseAmp enters speaker configuration and displays the adjusted headphone impedance.

Click to manually adjust the amplify level
Displays the impedance of your headphone

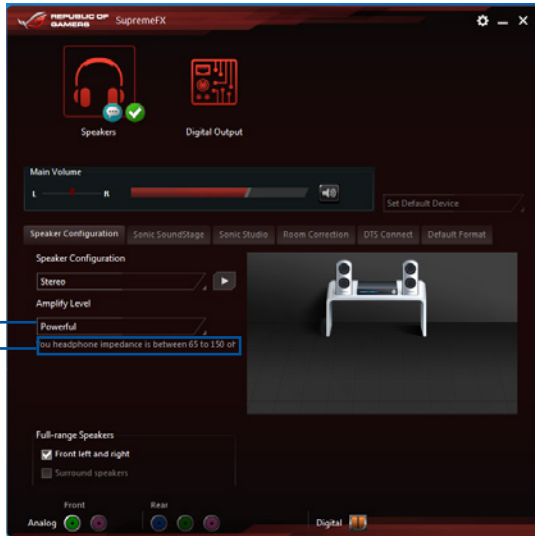

4.7.3 Sonic SoundStage

Sonic SoundStage is a hardware based sound solution for virtual Sound Stage that offers four preset gaming profiles: FPS, Racing, Fighting and Sports.



- This feature is only available for front panel Headphone output.
- You can enable this feature by enabling the dedicated SoundStage button on your motherboard. Refer to section 1.2.6 Onboard buttons of this user guide for more information.

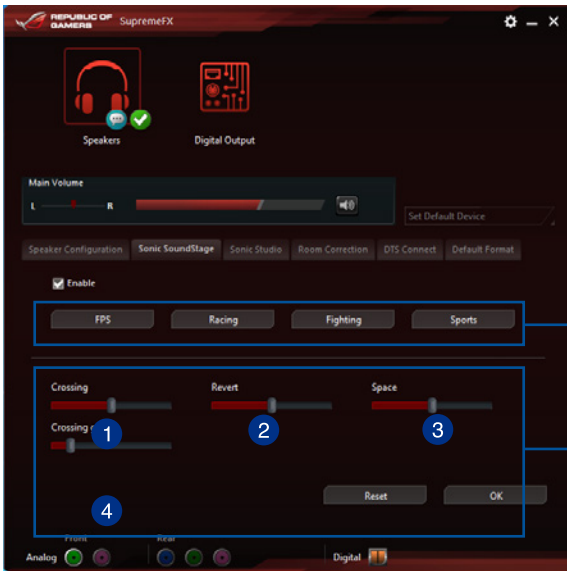

Click any of the four preset gaming profiles

Use the slider to manually adjust the setting of an item

- 1 Crossing**
Move the slider to adjust the amount of cross channel mixing.
- 2 Revert**
Move the slider to revert the main audio source.
- 3 Space**
Move the slider to adjust and virtualize the space sound.
- 4 Crossing gain**
This item only works when Crossing and Revert is enabled. Move the slider to adjust the hardness of the wall.

DTS Connect

DTS Connect delivers excellent audio entertainment across all formats and works with 4, 5.1 and 7.1 channels of incredible surround sound . It also allows you to connect your computer to a home theatre system.

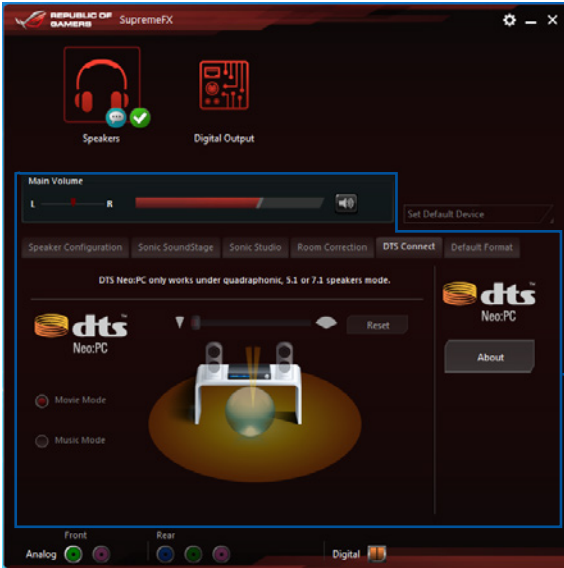

Control settings panel



4.8 Sonic Radar II

Sonic Radar II is designed for First Person Shooting (FPS) games and shows the precise direction and intensity of where a sound is coming from. It features a simple and friendly user-interface and also features sound enhancers to amplify desired sound effects.



- The Sonic Radar II application does not have its independent installer. It is automatically installed when the Realtek® Audio Driver is installed in your system.
- Sonic Radar II will not launch after its installation. Launch the application from your desktop or from All Programs menu.



You can also enable or launch Sonic Radar II after system startup. To do this, click  from the taskbar then right-click  and click **Enable Sonic Radar** or **Enable Launch at Startup**.

Display Menu

Customize the settings for each game including Transparency, Signal, Size, and Remanency.

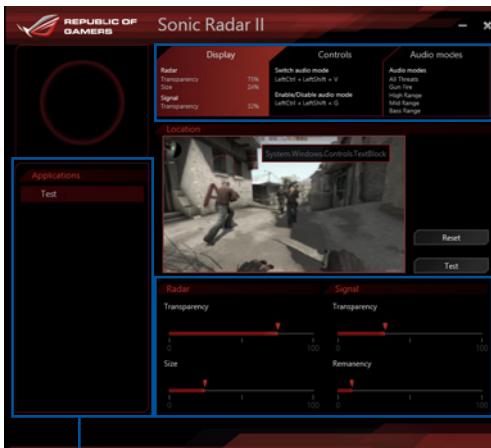

Displays the options available. Click a tab to select an option. Each option has its own settings and menus.

Click to reset to the default settings
Click to start the test tone

Use the sliders to adjust the settings

Displays the list of games

Control Menu

Allows you to configure shortcut keys.

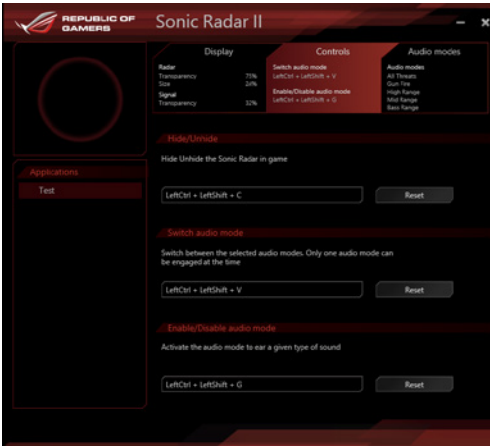

Audio Mode/Radar Selection menu

Allows you to configure the sound enhancers.

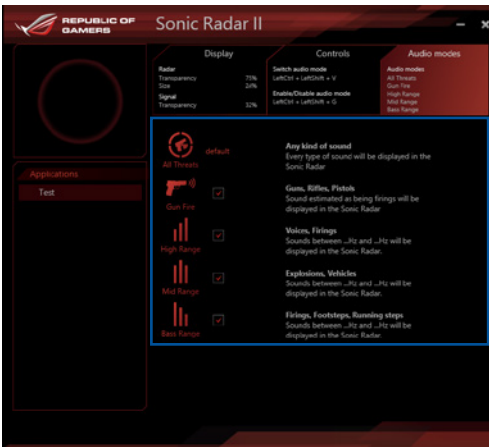

Audio Mode/Radar Selection are enabled with shortcut keys in the game. Refer to the **Controls** tab for more information about the shortcut key settings.

4.9 GameFirst III

GameFirst III is a network management software that features four preset packet prioritized profiles (Optimization, Game, Media Streaming and File Sharing) facilitating different user scenarios. Users can also manually allocate bandwidth and adjust priority settings of each application to run faster and smoother.

To use GameFirst III, double-click  on the desktop.

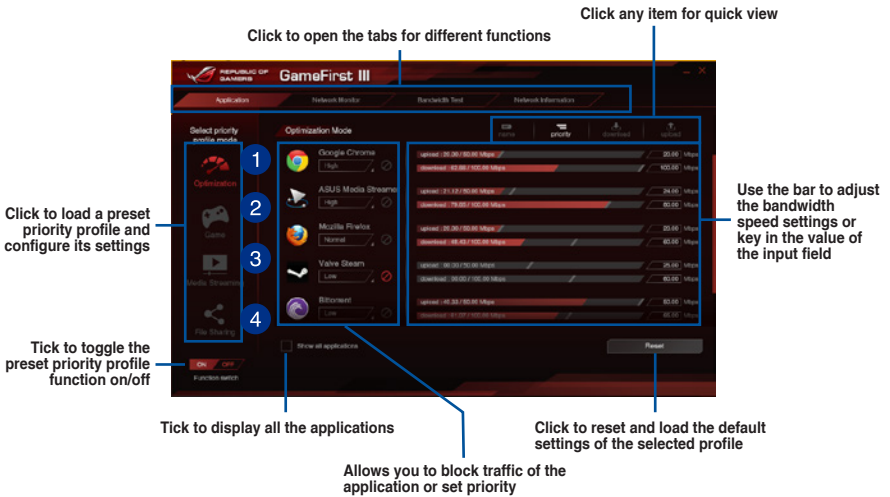

- 1 Optimization Mode**
Game packets are prioritized and other packets also optimized.
- 2 Game Mode**
Game packets given top priority.
- 3 Media Streaming Mode**
Media-streaming packets given top priority.
- 4 File Sharing Mode**
File-sharing packets given top priority.

Network Monitor

Top 5 application

Displays the top 5 bandwidth consuming applications currently used.



Application usage

Displays the individual downloading and uploading bandwidth of currently used applications.

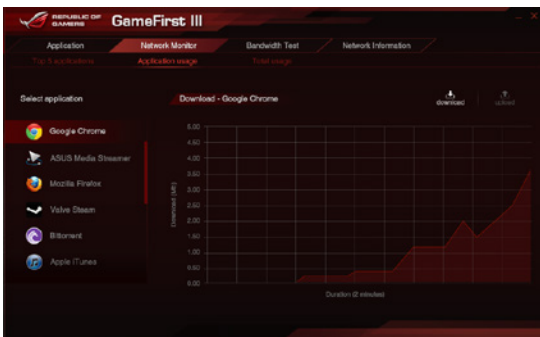

Total usage

Displays the total downloading and uploading bandwidth of the currently used applications.

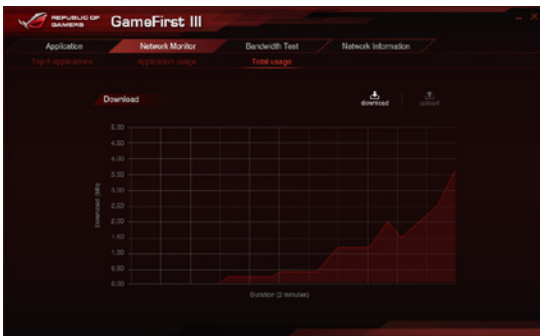

Bandwidth Test

You can use this feature to test the Internet Service Provider (ISP) speed or manually key in the desired uploading/downloading speed and apply the speed if needed.

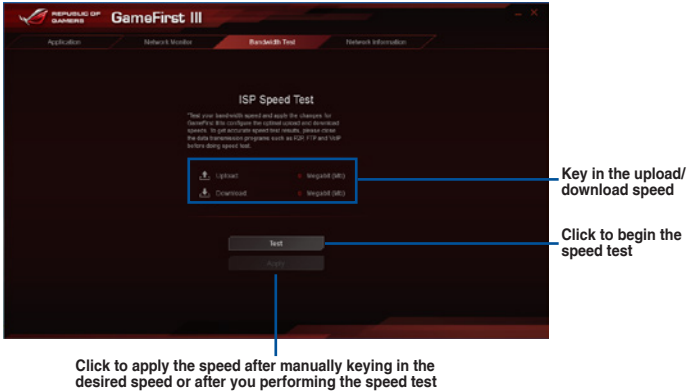

Network Information

Displays information about the physical network card such as speed, physical address, IP address, subnet mask, and default gateway.



4.10 Keybot

KeyBot is a built-in microprocessor that provides instant upgrade to your keyboard. You can configure and assign macros to specific keys on your keyboard to perform specific or several task at the same time. You can also configure your computer to wake up in CPU Level UP, XMP, or directly to BIOS mode.

To use KeyBot:

1. Press the KeyBot button on the motherboard.



The KeyBot feature is enabled when the KEYBOT_LED light is on.

2. Connect the USB keyboard into the dedicated KeyBot USB port.



Refer to sections **2.3.1 Rear I/O connection** or **2.2 BIOS update utility** or more information about the location of the KeyBot USB port.

3. Double-click  on the desktop to launch the KeyBot application on your computer.

Click to import or export configuration files

Click to configure Macro keys, Smart login, Function keys, and Shortcut settings

Tick to toggle the KeyBot function on/off

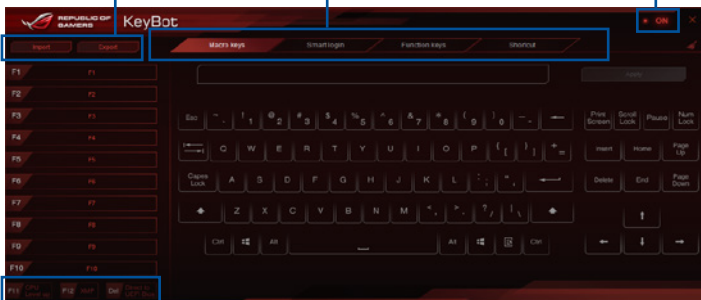

Click any of the items to perform a specific tasks, or click their corresponding keys on the keyboard

Smart login

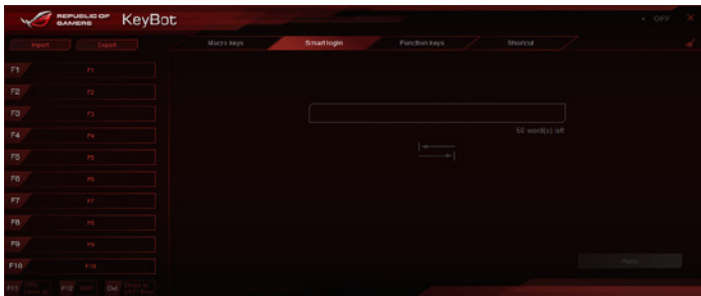

Function Keys

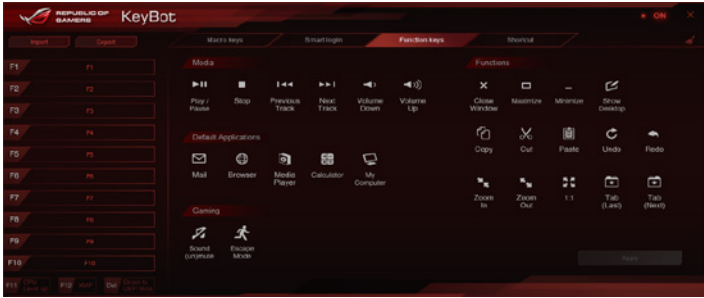

Shortcut

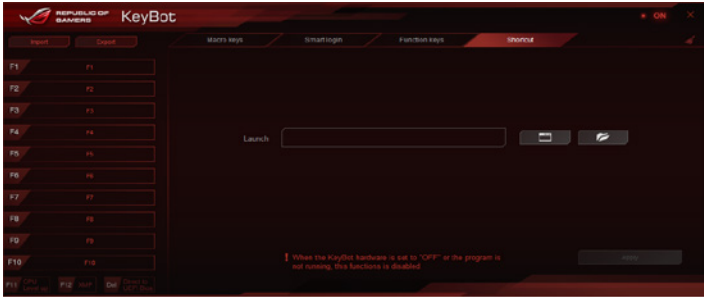

4.11 MemTweakIt

MemTweakIt is a software that you can use to view all levels of memory timings. You can validate your MemTweakIt settings to generate a memory efficiency score that you can share and compare with other users on the ROG website.



MemTweakIt functions depends on the chipset on the motherboard. Each chipset has different options.

To use MemTweakIt, double-click  on the desktop.



Click a tab to configure the memory timing

Click About tab then click REPUBLIC OF GAMERS to access the official ROG website



Validating and saving your MemTweakIt settings

To validate and save your configuration online:

1. Launch MemTweakIt and click **Validate**.
2. In **Online Mode**, key in your ASUS account ID and password, and click **Submit**.



Your configuration will be displayed in MemTweakIt webpage.

To validate and save your configuration manually:

1. Launch MemTweakIt and click **Validate**.
2. In **Manual Mode**, click **Save Validation File**.
3. Key in a file name for your configuration file and click **Submit**.
4. Click **validation webpage**.

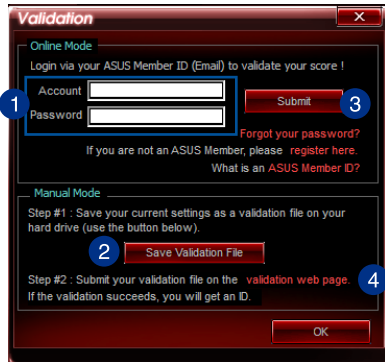

5. In **MemTweakIt - Validation File Upload** window, key in your ASUS account ID and password.
6. Click **Browse**, locate the saved .cvf file, and click **Open**.
7. Click **Submit**.

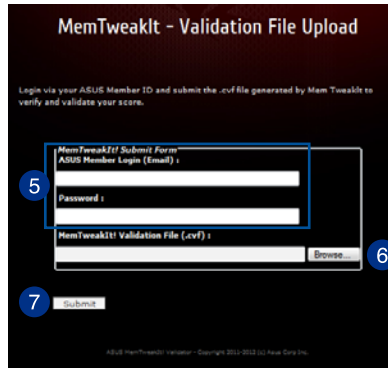

Your configuration will be displayed in MemTweakIt webpage.

4.12 RAMDisk

RAMDisk is a data-storage software that reserves a part of your system's memory and turns it into a high-speed virtual drive where you can store cache files and game apps for instant access. The Dynamic Memory Allocation function can release the unused memory of RAMDisk back to the system when needed and helps extend the lifespan of your SSD or HDD.



The following folders are not suitable for RAMDisk optimization. Moving them into the RAMDisk might negatively affect the performance of your system.

- **Swap file/Page file:** The swap file is a permanent storage space used as the virtual memory expansion of the system memory. Moving the swap file into the RAM Disk simply defeats the whole purpose of having it and may affect your system's performance.
- **Startup folders:** Since RAMDisk loads during boot up together with the contents of the Junction folders, changing the location of the startup folders may cause system error and disable loading your RAMDisk.



To launch RAMDisk, click

Creating/Deleting a RAMDisk drive

Your RAMDisk drive allows you to place your favorite applications and files into RAM so you can utilize your RAM speed for better read/write performance. The files that are stored inside the RAMDisk are automatically backed up every time your computer is turned off.



The startup time may take a while, depending on the size of your RAMDisk drive.

To create RAMDisk drives:

The screenshot shows the RAMDisk application window. Annotations with blue arrows point to various controls:

- Click to create RAMDisk drives:** Points to the 'Disk' button at the top.
- Click the drop-down arrow to choose a drive name for your RAMDisk:** Points to the 'G' drive letter dropdown menu.
- Move the slider to the right to set the size allocation:** Points to the size slider set to 16 MB.
- Click to finish creating the RAMDisk drive:** Points to the 'Add' button.
- Tick to enable Dynamic Memory Allocation function:** Points to the checked 'Dynamic Memory Allocation' checkbox.

Disk	Size	Format	Delete
P	16MB		

To delete or format an existing RAMDisk drive:

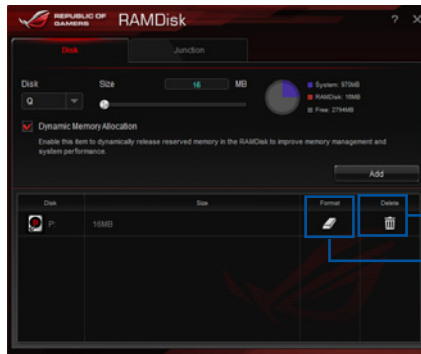

The format function is available only if you enable the Dynamic Memory Allocation function on your disk.

Creating/Deleting a Junction Point

A junction point creates a link that remaps the original contents into the RAMDisk, enabling access to the desired application or data to be done purely within the original file location.

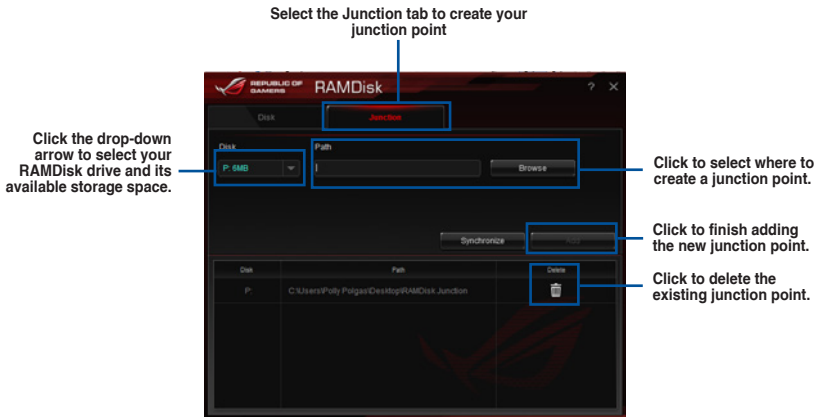

Synchronizing backup files

After creating a junction point, RAMDisk automatically creates a backup folder in the file's original location. Use RAMDisk to manually synchronize updates with these backup files.

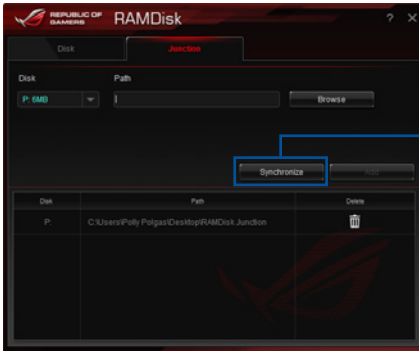

Click Synchronize to update your files

4.13 ROG CPU-Z

This utility gathers information about the main devices installed in your system and displays it in an ROG custom layout. ROG CPU-Z provides you information and status of your CPU, motherboard, memory, graphics card, and other components installed in your system. You can generate a report about your system info and send or post it on the CPU-Z website.

To use ROG CPU-Z, double-click  on the desktop.

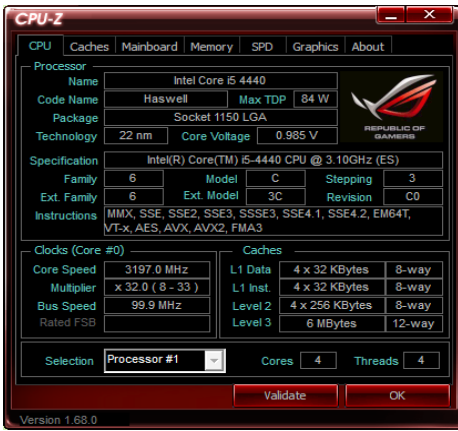

RAID support

5

5.1 RAID configurations

The motherboard comes with the Intel® Rapid Storage Technology that supports RAID 0, RAID 1, RAID 10, and RAID 5 configuration.



If you want to install a Windows® operating system to a hard disk drive included in a RAID set, you have to create a RAID driver disk and load the RAID driver during OS installation. Refer to section 5.2 **Creating a RAID driver disk** for details.

5.1.1 RAID definitions

RAID 0 (Data striping) optimizes two identical hard disk drives to read and write data in parallel, interleaved stacks. Two hard disks perform the same work as a single drive but at a sustained data transfer rate, double that of a single disk alone, thus improving data access and storage. Use of two new identical hard disk drives is required for this setup.

RAID 1 (Data mirroring) copies and maintains an identical image of data from one drive to a second drive. If one drive fails, the disk array management software directs all applications to the surviving drive as it contains a complete copy of the data in the other drive. This RAID configuration provides data protection and increases fault tolerance to the entire system. Use two new drives or use an existing drive and a new drive for this setup. The new drive must be of the same size or larger than the existing drive.

RAID 5 stripes both data and parity information across three or more hard disk drives. Among the advantages of RAID 5 configuration include better HDD performance, fault tolerance, and higher storage capacity. The RAID 5 configuration is best suited for transaction processing, relational database applications, enterprise resource planning, and other business systems. Use a minimum of three identical hard disk drives for this setup.

RAID 10 is data striping and data mirroring combined without parity (redundancy data) having to be calculated and written. With the RAID 10 configuration you get all the benefits of both RAID 0 and RAID 1 configurations. Use four new hard disk drives or use an existing drive and three new drives for this setup.

5.1.2 Installing Serial ATA hard disks

The motherboard supports Serial ATA hard disk drives. For optimal performance, install identical drives of the same model and capacity when creating a disk array.

To install the SATA hard disks for a RAID configuration:

1. Install the SATA hard disks into the drive bays.
2. Connect the SATA signal cables.
3. Connect a SATA power cable to the power connector on each drive.

5.1.3 Setting the RAID item in BIOS

You must enable the RAID function in the BIOS Setup before creating RAID sets using SATA HDDs. To do this:

1. Enter the BIOS Setup during POST.
2. Go to the **Advanced** menu > **SATA Configuration**, and then press <Enter>.
3. Set the SATA Mode item to **[RAID Mode]**.
4. Save your changes, and then exit the BIOS Setup.



Refer to Chapter 3 for details on entering and navigating through the BIOS Setup



Due to chipset limitation, when SATA ports are set to RAID mode, all SATA ports run at RAID mode together.

5.1.4 Intel® Rapid Storage Technology Option ROM utility

To enter the Intel® Rapid Storage Technology Option ROM utility:

1. Turn on the system.
2. During POST, press <Ctrl> + <I> to display the utility main menu.

```
Intel(R) Rapid Storage Technology - Option - v10.5.1.1070
Copyright(C) 2003-14 Intel Corporation. All Rights Reserved.

[ MAIN MENU ]

1. Create RAID Volume          4. Recovery Volume Options
2. Delete RAID Volume         5. Acceleration Options
3. Reset Disks to Non-RAID    6. Exit

[ DISK/VOLUME INFORMATION ]

RAID Volumes:
None defined.

Physical Devices:
Port  Device Model  Serial #      Size   Type/Status (Vol ID)
0      ST3160812AS      9LS0HJA4     149.0GB Non-RAID Disk
1      ST3160812AS      9LS0F4HL     149.0GB Non-RAID Disk
2      ST3160812AS      3LS0JYL8     149.0GB Non-RAID Disk
3      ST3160812AS      9LS0BJ5H     149.0GB Non-RAID Disk

[↑↓]-Select      [ESC]-Exit      [ENTER]-Select Menu
```

The navigation keys at the bottom of the screen allow you to move through the menus and select the menu options.



The RAID BIOS setup screens shown in this section are for reference only and may not exactly match the items on your screen.



The utility supports maximum four hard disk drives for RAID configuration.

Creating a RAID set

To create a RAID set:

1. From the utility main menu, select **1. Create RAID Volume** and press <Enter>. The following screen appears:

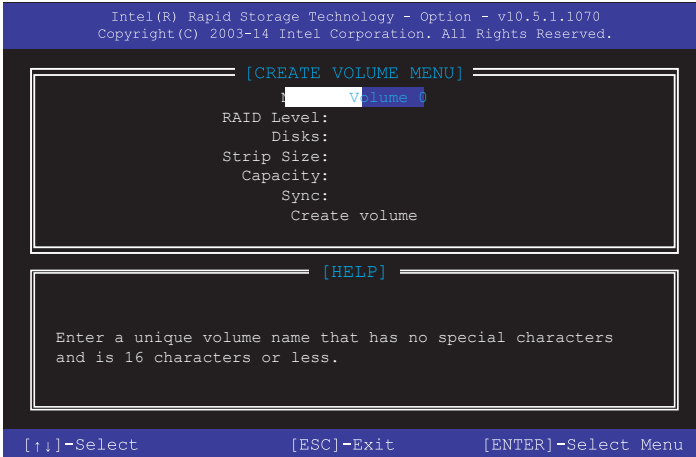

2. Enter a name for the RAID set and press <Enter>.
3. When the RAID Level item is selected, press the up/down arrow key to select a RAID level to create, and then press <Enter>.
4. When the Disks item is selected, press <Enter> to select the hard disk drives you want to include in the RAID set. The SELECT DISKS screen appears:

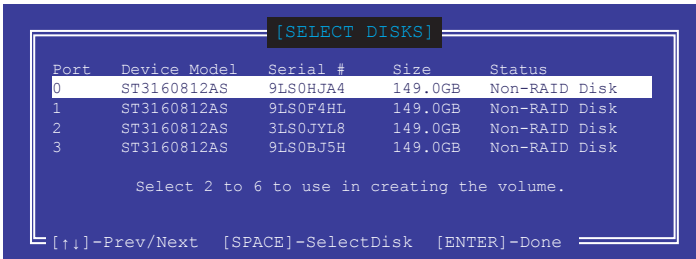

5. Use the up/down arrow key to select a drive, and then press <Space> to select. A small triangle marks the selected drive. Press <Enter> after completing your selection.
6. Use the up/down arrow key to select the stripe size for the RAID array (for RAID 0, 10 and 5 only), then press <Enter>. The available stripe size values range from 4 KB to 128 KB. The following are typical values:
 - RAID 0: 128 KB
 - RAID 10: 64 KB
 - RAID 5: 64 KB



We recommend a lower stripe size for server systems, and a higher stripe size for multimedia computer systems used mainly for audio and video editing.

7. When the **Capacity** item is selected, enter the RAID volume capacity that you want and press <Enter>. The default value indicates the maximum allowed capacity.
8. When the **Create Volume** item is selected, press <Enter>. The following warning message appears:

```
WARNING: ALL DATA ON SELECTED DISKS WILL BE LOST.  
Are you sure you want to create this volume? (Y/N)
```

9. Press <Y> to create the RAID volume and return to the main menu, or <N> to go back to the **CREATE VOLUME** menu.

Deleting a RAID set



Be cautious when deleting a RAID set. You will lose all data on the hard disk drives when you delete a RAID set.

To delete a RAID set:

1. From the utility main menu, select **2. Delete RAID Volume** and press <Enter>. The following screen appears:

```
[DELETE VOLUME MENU]
Name      Level      Drives      Capacity      Status      Bootable
Volume0   RAID0 (Stripe)  2           298.0GB      Normal      Yes

[HELP]

Deleting a volume will reset the disks to non-RAID.

WARNING: ALL DISK DATA WILL BE DELETED.
(This does not apply to Recovery volumes)

[↑]-Select [ESC]-Previous Menu [DEL]-Delete Volume
```

2. Use the up/down arrow key to select the RAID set you want to delete, and then press <Delete>. The following warning message appears:

```
[DELETE VOLUME VERIFICATION]

ALL DATA IN THE VOLUME WILL BE LOST!
(This does not apply to Recovery volumes)

Are you sure you want to delete "Volume0"? (Y/N):
```

3. Press <Y> to delete the RAID set and return to the utility main menu, or press <N> to return to the DELETE VOLUME menu.

Exiting the Intel® Rapid Storage Technology Option ROM utility

To exit the utility:

1. From the utility main menu, select **5. Exit**, then press <Enter>. The following warning message appears:

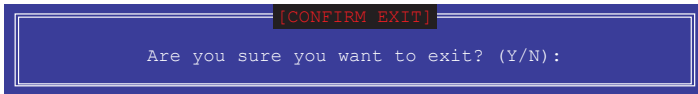

2. Press <Y> to exit or press <N> to return to the utility main menu.

5.2 Creating a RAID driver disk

A floppy disk with the RAID driver is required when installing a Windows® operating system on a hard disk drive that is included in a RAID set.



The motherboard does not provide a floppy drive connector. You have to use a USB floppy disk drive when creating a SATA RAID driver disk.

5.2.1 Creating a RAID driver disk without entering the OS

To create a RAID driver disk without entering the OS:

1. Boot your computer.
2. Press <Delete> during POST to enter the BIOS setup utility.
3. Set the optical drive as the primary boot device.
4. Insert the support DVD into the optical drive.
5. Save changes and exit BIOS.
6. When the Make Disk menu appears, press <1> to create a RAID driver disk.
7. Insert a formatted floppy disk into the USB floppy disk drive, then press <Enter>.
8. Follow the succeeding screen instructions to complete the process.

5.2.2 Creating a RAID driver disk in Windows®

To create a RAID driver disk in Windows®:

1. Start Windows®.
2. Plug the USB floppy disk drive and insert a floppy disk.
3. Place the motherboard support DVD into the optical drive.
4. Go to the **Intel AHCI/RAID Driver** menu then click **Intel AHCI/RAID Driver path** to open the RAID driver folder.
5. Select **32bit** or **64bit** folder depending on your operating system. Copy the files of the selected folder to the root path of your USB floppy disk drive.



Write-protect the floppy disk to avoid a computer virus infection.

5.2.3 Installing the RAID driver during Windows® OS installation

To install the RAID driver for Windows® 7:

1. During the OS installation, click **Load Driver** to allow you to select the installation media containing the RAID driver.
2. Insert the USB flash drive with RAID driver into the USB port or the support DVD into the optical drive, and then click **Browse**.
3. Click the name of the device you've inserted, go to **Drivers > RAID**, and then select the RAID driver for the corresponding OS version. Click **OK**.
4. Follow the succeeding screen instructions to complete the installation.



Before loading the RAID driver from a USB flash drive, you have to use another computer to copy the RAID driver from the support DVD to the USB flash drive.



To set up a Windows® UEFI operating system under RAID mode, ensure to load the UEFI driver for your optical drive.

Appendices

Notices

Federal Communications Commission Statement

This device complies with Part 15 of the FCC Rules. Operation is subject to the following two conditions:

- This device may not cause harmful interference.
- This device must accept any interference received including interference that may cause undesired operation.

This equipment has been tested and found to comply with the limits for a Class B digital device, pursuant to Part 15 of the FCC Rules. These limits are designed to provide reasonable protection against harmful interference in a residential installation. This equipment generates, uses and can radiate radio frequency energy and, if not installed and used in accordance with manufacturer's instructions, may cause harmful interference to radio communications. However, there is no guarantee that interference will not occur in a particular installation. If this equipment does cause harmful interference to radio or television reception, which can be determined by turning the equipment off and on, the user is encouraged to try to correct the interference by one or more of the following measures:

- Reorient or relocate the receiving antenna.
- Increase the separation between the equipment and receiver.
- Connect the equipment to an outlet on a circuit different from that to which the receiver is connected.
- Consult the dealer or an experienced radio/TV technician for help.



The use of shielded cables for connection of the monitor to the graphics card is required to assure compliance with FCC regulations. Changes or modifications to this unit not expressly approved by the party responsible for compliance could void the user's authority to operate this equipment.

IC: Canadian Compliance Statement

Complies with the Canadian ICES-003 Class B specifications. This device complies with RSS 210 of Industry Canada. This Class B device meets all the requirements of the Canadian interference-causing equipment regulations.

This device complies with Industry Canada license exempt RSS standard(s). Operation is subject to the following two conditions: (1) this device may not cause interference, and (2) this device must accept any interference, including interference that may cause undesired operation of the device.

Cet appareil numérique de la Classe B est conforme à la norme NMB-003 du Canada. Cet appareil numérique de la Classe B respecte toutes les exigences du Règlement sur le matériel brouilleur du Canada.

Cet appareil est conforme aux normes CNR exemptes de licence d'Industrie Canada. Le fonctionnement est soumis aux deux conditions suivantes :

- (1) cet appareil ne doit pas provoquer d'interférences et
- (2) cet appareil doit accepter toute interférence, y compris celles susceptibles de provoquer un fonctionnement non souhaité de l'appareil.

Canadian Department of Communications Statement

This digital apparatus does not exceed the Class B limits for radio noise emissions from digital apparatus set out in the Radio Interference Regulations of the Canadian Department of Communications.

This class B digital apparatus complies with Canadian ICES-003.

VCCI: Japan Compliance Statement

VCCI Class B Statement

情報処理装置等電波障害自主規制について

この装置は、情報処理装置等電波障害自主規制協議会（VCCI）の基準に基づくクラスB情報技術装置です。この装置は家庭環境で使用されることを目的としていますが、この装置がラジオやテレビジョン受信機に近接して使用されると、受信障害を引き起こすことがあります。

取扱説明書に従って正しい取り扱いをして下さい。

KC: Korea Warning Statement

B급 기기 (가정용 방송통신기자재)

이 기기는 가정용(B급) 전자파적합기기로서 주로 가정에서 사용하는 것을 목적으로 하며, 모든 지역에서 사용할 수 있습니다.

*당해 무선설비는 전파통신 가능성이 있으므로 인명안전과 관련된 서비스는 할 수 없습니다.

REACH

Complying with the REACH (Registration, Evaluation, Authorisation, and Restriction of Chemicals) regulatory framework, we published the chemical substances in our products at ASUS REACH website at <http://csr.asus.com/english/REACH.htm>.



DO NOT throw the motherboard in municipal waste. This product has been designed to enable proper reuse of parts and recycling. This symbol of the crossed out wheeled bin indicates that the product (electrical and electronic equipment) should not be placed in municipal waste. Check local regulations for disposal of electronic products.



DO NOT throw the mercury-containing button cell battery in municipal waste. This symbol of the crossed out wheeled bin indicates that the battery should not be placed in municipal waste.

ASUS Recycling/Takeback Services

ASUS recycling and takeback programs come from our commitment to the highest standards for protecting our environment. We believe in providing solutions for you to be able to responsibly recycle our products, batteries, other components as well as the packaging materials. Please go to <http://csr.asus.com/english/Takeback.htm> for detailed recycling information in different regions.

RF Equipment Notices

CE: European Community Compliance Statement

The equipment complies with the RF Exposure Requirement 1999/519/EC, Council Recommendation of 12 July 1999 on the limitation of exposure of the general public to electromagnetic fields (0–300 GHz). This wireless device complies with the R&TTE Directive.

Wireless Radio Use

This device is restricted to indoor use when operating in the 5.15 to 5.25 GHz frequency band.

Exposure to Radio Frequency Energy

The radiated output power of the Wi-Fi technology is below the FCC radio frequency exposure limits. Nevertheless, it is advised to use the wireless equipment in such a manner that the potential for human contact during normal operation is minimized.

FCC Bluetooth Wireless Compliance

The antenna used with this transmitter must not be colocated or operated in conjunction with any other antenna or transmitter subject to the conditions of the FCC Grant.

Bluetooth Industry Canada Statement

This Class B device meets all requirements of the Canadian interference-causing equipment regulations.

Cet appareil numérique de la Class B respecte toutes les exigences du Règlement sur le matériel brouilleur du Canada.

NCC: Taiwan Wireless Statement

無線設備的警告聲明

經型式認證合格之低功率射頻電機，非經許可，公司、商號或使用者均不得擅自變更射頻、加大功率或變更原設計之特性及功能。低功率射頻電機之使用不得影響飛航安全及干擾合法通信；經發現有干擾現象時，應立即停用，並改善至無干擾時方得繼續使用。前項合法通信指依電信法規定作業之無線通信。低功率射頻電機須忍受合法通信或工業、科學及醫療用電波輻射性電機設備之干擾。

於 5.25GHz 至 5.35GHz 區域內操作之
無線設備的警告聲明

工作頻率 5.250 ~ 5.350GHz 該頻段限於室內使用。

Japan RF Equipment Statement

この製品は、周波数帯域5.15~5.35GHzで動作しているときは、屋内においてのみ使用可能です。

KC (RF Equipment)

대한민국 규정 및 준수

방통위고시에 따른 고지사항

해당 무선설비는 운용 중 전파혼신 가능성이 있음,

이 기기는 인명안전과 관련된 서비스에 사용할 수 없습니다.

Google™ License Terms

Copyright© 2014 Google Inc. All Rights Reserved.

Licensed under the Apache License, Version 2.0 (the "License"); you may not use this file except in compliance with the License. You may obtain a copy of the License at:

<http://www.apache.org/licenses/LICENSE-2.0>

Unless required by applicable law or agreed to in writing, software distributed under the License is distributed on an "AS IS" BASIS, WITHOUT WARRANTIES OR CONDITIONS OF ANY KIND, either express or implied.

See the License for the specific language governing permissions and limitations under the License.

ASUS contact information

ASUSTeK COMPUTER INC.

Address 15 Li-Te Road, Peitou, Taipei, Taiwan 11259
Telephone +886-2-2894-3447
Fax +886-2-2890-7798
E-mail info@asus.com.tw
Web site www.asus.com.com/

Technical Support

Telephone +86-21-38429911
Fax +86-21-5866-8722, ext. 9101#
Online support <http://www.asus.com/tw/support/>

ASUS COMPUTER INTERNATIONAL (America)

Address 800 Corporate Way, Fremont, CA 94539, USA
Telephone +1-510-739-3777
Fax +1-510-608-4555
Web site <http://www.asus.com/us/>

Technical Support

Support fax +1-812-284-0883
Telephone +1-812-282-2787
Online support <http://www.service.asus.com/>

ASUS COMPUTER GmbH (Germany and Austria)

Address Harkort Str. 21-23, D-40880 Ratingen, Germany
Fax +49-2102-959911
Web site <http://www.asus.com/de>
Online contact <http://eu-rma.asus.com/sales>

Technical Support

Telephone +49-1805-010923*
Support Fax +49-2102-9599-11
Online support <http://www.asus.com/de/support/>

DECLARATION OF CONFORMITY

Per FCC Part 2, Section 2.1077(a)



Responsible Party Name: **Asus Computer International**

Address: **800 Corporate Way, Fremont, CA 94539.**

Phone/Fax No: **(510)739-3777/(510)608-4555**

hereby declares that the product

Product Name : Motherboard

Model Number : MAXIMUS VII IMPACT

Conforms to the following specifications:

- FCC Part 15, Subpart B, Unintentional Radiators

Supplementary Information:

This device complies with part 15 of the FCC Rules. Operation is subject to the following two conditions: (1) This device may not cause harmful interference, and (2) this device must accept any interference received, including interference that may cause undesired operation.

Representative Person's Name : Steve Chang / President

Signature :

Steve Chang

Date : July, 31, 2014

Ver. 146331

EC Declaration of Conformity



We, the undersigned,

Manufacturer: **ASUSTek COMPUTER INC.**
 Address: **4F, No. 150, LITE Rd., PEITOU, TAIPEI 112, TAIWAN**
 Authorized representative in Europe: **ASUS COMPUTER GmbH**
 Address, City: **HARKORT STR. 21-23, 40880 RATINGEN**
 Country: **GERMANY**

declare the following apparatus:

Product name : **Motherboard**
 Model name : **MAXIMUS VII IMPACT**

conform with the essential requirements of the following directives:

- 2004/108/EC-EMC Directive**
- EN 55022:2010-A2:2011
- EN 61000-3-2:2006+A2:2009
- EN 61000-3-3:2013
- EN 30522:2007+A11:2011

UNBENEFICIAL STATE DIRECTIVE

- EN 301 489-1 V1.9.2 (2011-09)
- EN 301 489-3 V1.4 (2002-08)
- EN 301 489-4 V1.4 (2009-05)
- EN 301 489-7 V1.1 (2007-11)
- EN 301 489-9 V1.4 (2007-11)
- EN 301 489-17 V2.2 (2012-09)
- EN 301 489-18 V2.2 (2012-09)
- EN 302 285-2 V1.2.2 (2010-06)
- EN 302 285-3 V1.3 (2007-09)
- EN 301 357-2 V1.4 (2008-11)
- EN 302 291-2 V1.1 (2005-07)

2006/95/EC-LVD Directive

- EN 60950-1 A12:2011
- EN 60065:2002 / A12:2011

2009/125/EC-ErP Directive

- Regulation (EC) No. 1275/2008
- Regulation (EC) No. 642/2009
- Regulation (EC) No. 617/2013

2011/65/EU-RoHS Directive

- Ce marking**



(EC conformity marking)

Position : **CEO**
 Name : **Jerry Shen**

Jerry Shen

Signature : _____

Declaration Date: **31/07/2014**
 Year to begin affixing CE marking: **2014**

Ver. 140331