

**GRYPHON Z97  
ARMOR EDITION**



**Motherboard**

**Copyright© 2014 ASUSTeK COMPUTER INC. All Rights Reserved.**

No part of this manual, including the products and software described in it, may be reproduced, transmitted, transcribed, stored in a retrieval system, or translated into any language in any form or by any means, except documentation kept by the purchaser for backup purposes, without the express written permission of ASUSTeK COMPUTER INC. ("ASUS").

Product warranty or service will not be extended if: (1) the product is repaired, modified or altered, unless such repair, modification of alteration is authorized in writing by ASUS; or (2) the serial number of the product is defaced or missing.

ASUS PROVIDES THIS MANUAL "AS IS" WITHOUT WARRANTY OF ANY KIND, EITHER EXPRESS OR IMPLIED, INCLUDING BUT NOT LIMITED TO THE IMPLIED WARRANTIES OR CONDITIONS OF MERCHANTABILITY OR FITNESS FOR A PARTICULAR PURPOSE. IN NO EVENT SHALL ASUS, ITS DIRECTORS, OFFICERS, EMPLOYEES OR AGENTS BE LIABLE FOR ANY INDIRECT, SPECIAL, INCIDENTAL, OR CONSEQUENTIAL DAMAGES (INCLUDING DAMAGES FOR LOSS OF PROFITS, LOSS OF BUSINESS, LOSS OF USE OR DATA, INTERRUPTION OF BUSINESS AND THE LIKE), EVEN IF ASUS HAS BEEN ADVISED OF THE POSSIBILITY OF SUCH DAMAGES ARISING FROM ANY DEFECT OR ERROR IN THIS MANUAL OR PRODUCT.

SPECIFICATIONS AND INFORMATION CONTAINED IN THIS MANUAL ARE FURNISHED FOR INFORMATIONAL USE ONLY, AND ARE SUBJECT TO CHANGE AT ANY TIME WITHOUT NOTICE, AND SHOULD NOT BE CONSTRUED AS A COMMITMENT BY ASUS. ASUS ASSUMES NO RESPONSIBILITY OR LIABILITY FOR ANY ERRORS OR INACCURACIES THAT MAY APPEAR IN THIS MANUAL, INCLUDING THE PRODUCTS AND SOFTWARE DESCRIBED IN IT.

Products and corporate names appearing in this manual may or may not be registered trademarks or copyrights of their respective companies, and are used only for identification or explanation and to the owners' benefit, without intent to infringe.

**Offer to Provide Source Code of Certain Software**

This product contains copyrighted software that is licensed under the General Public License ("GPL"), under the Lesser General Public License Version ("LGPL") and/or other Free Open Source Software Licenses. Such software in this product is distributed without any warranty to the extent permitted by the applicable law. Copies of these licenses are included in this product.

Where the applicable license entitles you to the source code of such software and/or other additional data, you may obtain it for a period of three years after our last shipment of the product, either

(1) for free by downloading it from <http://support.asus.com/download>

or

(2) for the cost of reproduction and shipment, which is dependent on the preferred carrier and the location where you want to have it shipped to, by sending a reQuest to:

ASUSTeK Computer Inc.  
Legal Compliance Dept.  
15 Li Te Rd.,  
Beitou, Taipei 112  
Taiwan

In your reQuest please provide the name, model number and version, as stated in the About Box of the product for which you wish to obtain the corresponding source code and your contact details so that we can coordinate the terms and cost of shipment with you.

The source code will be distributed WITHOUT ANY WARRANTY and licensed under the same license as the corresponding binary/object code.

This offer is valid to anyone in receipt of this information.

ASUSTeK is eager to duly provide complete source code as reQuired under various Free Open Source Software licenses. If however you encounter any problems in obtaining the full corresponding source code we would be much obliged if you give us a notification to the email address [gpl@asus.com](mailto:gpl@asus.com), stating the product and describing the problem (please DO NOT send large attachments such as source code archives, etc. to this email address).

# Contents

Safety information.....	vi
About this guide.....	vii
GRYPHON Z97 ARMOR EDITION specifications summary.....	ix
Package contents.....	xiv
Installation tools and components.....	xv

## Chapter 1: Product Introduction

<b>1.1 Special features.....</b>	<b>1-1</b>
1.1.1 Product highlights.....	1-1
1.1.2 “Ultimate COOL” Thermal Solutions .....	1-2
1.1.3 “TUF Engine” Power Design .....	1-3
1.1.4 “Safe & Stable!” Guardian Angel.....	1-3
1.1.5 ASUS EZ DIY.....	1-4
1.1.6 ASUS Exclusive Features.....	1-5
1.1.7 Other special features.....	1-6
<b>1.2 Motherboard overview.....</b>	<b>1-7</b>
1.2.1 Before you proceed.....	1-7
1.2.2 Motherboard layout.....	1-8
1.2.3 Central Processing Unit (CPU) .....	1-10
1.2.4 System memory.....	1-11
1.2.5 Expansion slots.....	1-23
1.2.6 Onboard buttons .....	1-25
1.2.7 Jumpers.....	1-27
1.2.8 Onboard LEDs .....	1-29
1.2.9 Internal connectors.....	1-30

## Chapter 2: Basic installation

<b>2.1 Building your PC system.....</b>	<b>2-1</b>
2.1.1 Motherboard installation.....	2-1
2.1.2 CPU installation.....	2-3
2.1.3 CPU heatsink and fan assembly installation .....	2-4
2.1.4 DIMM installation.....	2-6
2.1.5 ATX Power connection.....	2-7
2.1.6 SATA device connection .....	2-8
2.1.7 Front I/O Connector .....	2-9
2.1.8 Expansion Card installation.....	2-10
<b>2.2 BIOS update utility.....</b>	<b>2-11</b>
<b>2.3 Motherboard rear and audio connections .....</b>	<b>2-12</b>
2.3.1 Rear I/O connection .....	2-12
2.3.2 Audio I/O connections.....	2-14

<b>2.4</b>	<b>Starting up for the first time</b> .....	<b>2-16</b>
<b>2.5</b>	<b>Turning off the computer</b> .....	<b>2-16</b>

**Chapter 3: BIOS setup**

<b>3.1</b>	<b>Knowing BIOS</b> .....	<b>3-1</b>
<b>3.2</b>	<b>BIOS setup program</b> .....	<b>3-2</b>
3.2.1	EZ Mode.....	3-3
3.2.2	Advanced Mode .....	3-4
3.2.3	Q-Fan Control .....	3-7
3.2.4	EZ Tuning Wizard .....	3-9
<b>3.3</b>	<b>My Favorites</b> .....	<b>3-10</b>
<b>3.4</b>	<b>Main menu</b> .....	<b>3-12</b>
<b>3.5</b>	<b>Ai Tweaker menu</b> .....	<b>3-14</b>
<b>3.6</b>	<b>Advanced menu</b> .....	<b>3-28</b>
3.6.1	CPU Configuration .....	3-29
3.6.2	PCH Configuration .....	3-32
3.6.3	PCH Storage Configuration.....	3-33
3.6.4	System Agent Configuration .....	3-35
3.6.5	USB Configuration .....	3-36
3.6.6	Platform Misc Configuration.....	3-37
3.6.7	Onboard Devices Configuration.....	3-39
3.6.8	APM Configuration.....	3-40
3.6.9	Network Stack Configuration.....	3-41
<b>3.7</b>	<b>Monitor menu</b> .....	<b>3-42</b>
<b>3.8</b>	<b>Boot menu</b> .....	<b>3-48</b>
<b>3.9</b>	<b>Tool menu</b> .....	<b>3-54</b>
3.9.1	ASUS EZ Flash 2 Utility .....	3-54
3.9.2	ASUS Overclocking Profile .....	3-55
3.9.3	ASUS SPD Information .....	3-56
<b>3.10</b>	<b>Exit menu</b> .....	<b>3-57</b>
<b>3.11</b>	<b>Updating BIOS</b> .....	<b>3-58</b>
3.11.1	EZ Update .....	3-58
3.11.2	ASUS EZ Flash 2 .....	3-59
3.11.3	ASUS CrashFree BIOS 3.....	3-60

**Chapter 4: Software support**

<b>4.1</b>	<b>Installing an operating system</b> .....	<b>4-1</b>
<b>4.2</b>	<b>Support DVD information</b> .....	<b>4-1</b>
4.2.1	Running the support DVD .....	4-1
4.2.2	Obtaining the software manuals.....	4-3

<b>4.3</b>	<b>Software information</b> .....	<b>4-4</b>
<b>4.4</b>	<b>AI Suite 3</b> .....	<b>4-4</b>
4.4.1	Thermal Radar 2 .....	4-7
4.4.2	EZ Update .....	4-12
4.4.3	USB BIOS Flashback.....	4-14
4.4.4	Push Notice.....	4-16
4.4.5	USB 3.0 Boost.....	4-19
4.4.6	System Information .....	4-20
4.4.7	USB Charger+.....	4-22
4.4.8	Version .....	4-23
<b>4.5</b>	<b>Turbo LAN</b> .....	<b>4-24</b>
<b>4.6</b>	<b>Audio configurations</b> .....	<b>4-25</b>

**Chapter 5: RAID support**

<b>5.1</b>	<b>RAID configurations</b> .....	<b>5-1</b>
5.1.1	RAID definitions .....	5-1
5.1.2	Installing Serial ATA hard disks .....	5-2
5.1.3	Setting the RAID item in BIOS .....	5-2
5.1.4	Intel® Rapid Storage Technology Option ROM utility.....	5-3
<b>5.2</b>	<b>Installing the RAID driver during Windows® OS installation</b> .....	<b>5-7</b>

**Appendices**

<b>Notices</b> .....	<b>A-1</b>
<b>ASUS contact information</b> .....	<b>A-5</b>

# Safety information

## Electrical safety

- To prevent electrical shock hazard, disconnect the power cable from the electrical outlet before relocating the system.
- When adding or removing devices to or from the system, ensure that the power cables for the devices are unplugged before the signal cables are connected. If possible, disconnect all power cables from the existing system before you add a device.
- Before connecting or removing signal cables from the motherboard, ensure that all power cables are unplugged.
- Seek professional assistance before using an adapter or extension cord. These devices could interrupt the grounding circuit.
- Ensure that your power supply is set to the correct voltage in your area. If you are not sure about the voltage of the electrical outlet you are using, contact your local power company.
- If the power supply is broken, do not try to fix it by yourself. Contact a Qualified service technician or your retailer.

## Operation safety

- Before installing the motherboard and adding devices on it, carefully read all the manuals that came with the package.
- Before using the product, ensure all cables are correctly connected and the power cables are not damaged. If you detect any damage, contact your dealer immediately.
- To avoid short circuits, keep paper clips, screws, and staples away from connectors, slots, sockets and circuitry.
- Avoid dust, humidity, and temperature extremes. Do not place the product in any area where it may become wet.
- Place the product on a stable surface.
- If you encounter technical problems with the product, contact a Qualified service technician or your retailer.

## About this guide

This user guide contains the information you need when installing and configuring the motherboard.

## How this guide is organized

This guide contains the following parts:

- **Chapter 1: Product introduction**  
This chapter describes the features of the motherboard and the new technology it supports. It includes description of the switches, jumpers, and connectors on the motherboard.
- **Chapter 2: Basic installation**  
This chapter lists the hardware setup procedures that you have to perform when installing system components.
- **Chapter 3: BIOS setup**  
This chapter tells how to change system settings through the BIOS Setup menus. Detailed descriptions of the BIOS parameters are also provided.
- **Chapter 4: Software support**  
This chapter describes the contents of the support DVD that comes with the motherboard package and the software.
- **Chapter 5: RAID support**  
This chapter describes the RAID configurations.

## Where to find more information

Refer to the following sources for additional information and for product and software updates.

1. **ASUS websites**  
The ASUS website provides updated information on ASUS hardware and software products. Refer to the ASUS contact information.
2. **Optional documentation**  
Your product package may include optional documentation, such as warranty flyers, that may have been added by your dealer. These documents are not part of the standard package.

## Conventions used in this guide

To ensure that you perform certain tasks properly, take note of the following symbols used throughout this manual.



**DANGER/WARNING:** Information to prevent injury to yourself when trying to complete a task.



**CAUTION:** Information to prevent damage to the components when trying to complete a task



**IMPORTANT:** Instructions that you **MUST** follow to complete a task.



**NOTE:** Tips and additional information to help you complete a task.

## Typography

**Bold text**

Indicates a menu or an item to select.

*Italics*

Used to emphasize a word or a phrase.

<Key>

Keys enclosed in the less-than and greater-than sign means that you must press the enclosed key.

Example: <Enter> means that you must press the Enter or Return key.

<Key1> + <Key2> + <Key3>

If you must press two or more keys simultaneously, the key names are linked with a plus sign (+).



## GRYPHON Z97 ARMOR EDITION specifications summary

CPU	<p>LGA1150 socket for the 4th, New 4th, and 5th generation Intel® Core™ i7 / Intel® Core™ i5 / Intel® Core™ i3, Pentium®, and Celeron® Processors</p> <p>Supports 22nm CPU</p> <p>Supports Intel® Turbo Boost Technology 2.0*</p> <p>* The Intel® Turbo Boost Technology 2.0 support depends on the CPU types.</p> <p>* Refer to <a href="http://www.asus.com">www.asus.com</a> for the complete CPU support list.</p>
Chipset	Intel® Z97 Express Chipset
Memory	<p>4 x DIMM, max. 32 GB, DDR3 1866 / 1600 / 1333 MHz, non-ECC, un-buffered Memory</p> <p>Dual channel memory architecture</p> <p>Supports Intel® Extreme Memory Profile (XMP)</p> <p>* Hyper DIMM support is subject to the physical characteristics of individual CPUs. Please refer to Memory QVL (Qualified Vendors List) for details.</p> <p>* Refer to <a href="http://www.asus.com">www.asus.com</a> or this user guide for the complete the Memory QVL (Qualified Vendors List).</p>
Expansion slots	<p>2 x PCI Express 3.0/2.0 x16 slots (single at x16 or dual at x8 /x8 mode)</p> <p>1 x PCI Express 2.0 x16 slot [black] (x4 mode)</p> <p>1 x PCI Express 2.0 x1 slot [brown]</p>
VGA	<p>Integrated Graphics Processor - Intel® HD Graphics support</p> <p>Multi-VGA output support: DisplayPort/HDMI/DVI port</p> <ul style="list-style-type: none"> <li>- Supports DisplayPort 1.2* with max. resolution of 4096 x 2160 @ 24Hz / 3840 x 2160 @ 60Hz</li> <li>- Supports HDMI with max. resolution of 4096 x 2160 @ 24Hz / 2560 x 1600 @ 60Hz</li> <li>- Supports DVI with max. resolution of 1920 x 1200 @ 60Hz</li> </ul> <p>Supports Intel® InTru™ 3D, Intel® Quick Sync Video, Intel® Clear Video HD Technology, and Intel® Insider™</p> <p>Maximum shared memory 512 MB</p> <p>* DisplayPort 1.2 Multi-Stream Transport compliant. Supports up to three displays of DisplayPort 1.2 monitors on a daisy chain.</p>
Multi-GPU support	<p>Supports NVIDIA® Quad-GPU SLI™ Technology</p> <p>Supports AMD® Quad-GPU CrossFireX™ Technology</p>
LAN	Intel® I218V Gigabit LAN controller

(continued on the next page)

# GRYPHON Z97 ARMOR EDITION specifications summary

Storage	<p><b>Intel® Z97 Express Chipset with RAID 0, 1, 5, 10 and Intel® Rapid Start Technology 13 support</b></p> <ul style="list-style-type: none"> <li>- 6 x SATA 6.0 Gb/s ports with RAID 0, 1, 5, and 10 support</li> <li>- Supports Intel® Smart Response Technology, Intel® Rapid Start Technology, and Intel® Smart Connect Technology*</li> </ul> <p>* These functions will work depending on the CPU installed.</p>
Audio	<p>Realtek® ALC892 8-channel High definition audio CODEC</p> <ul style="list-style-type: none"> <li>- Audio shielding ensures precision analog/digital separation and greatly reduced multi-lateral interference</li> <li>- Separate layer for left and right track, ensuring both sound deliver equal quality</li> <li>- Top notch audio sensation delivers according to the audio configuration</li> <li>- Audio amplifier to enhance the highest quality sound for headphone and speakers</li> <li>- High Quality 97dB SNR stereo playback output (Line-out at rear) and 90dB SNR recording input (Line-in) support</li> <li>- Absolute pitch 192khz/24bit true BD lossless sound</li> <li>- BD audio layer content protection</li> <li>- Supports jack-detection, multi-streaming, and front panel jack-retasking</li> <li>- Optical S/PDIF out ports at rear I/O</li> </ul>
USB	<p><b>Intel® Z97 Express Chipset - supports ASUS USB 3.0 Boost</b></p> <ul style="list-style-type: none"> <li>- 2 x USB 3.0/2.0 ports at mid-board for front panel support</li> <li>- 4 x USB 3.0/2.0 ports at back panel (blue)</li> <li>- 8 x USB 2.0/1.1 ports (4 ports at mid-board, 4 ports at back panel)</li> </ul>
Exclusive TUF Features	<p><b>“Ultimate COOL!” Thermal Solution</b></p> <ul style="list-style-type: none"> <li>- TUF ICe</li> <li>- TUF Thermal Armor</li> <li>- TUF Thermal Radar 2 with Thermistors</li> </ul> <p><b>“We Got Your Back!” Shape Force</b></p> <ul style="list-style-type: none"> <li>- TUF Fortifier</li> </ul> <p><b>“TUF ENGINE” Power Design</b></p> <ul style="list-style-type: none"> <li>- 8+2 Digital Phase Power Design</li> <li>- TUF Components (10K Ti-Cap, New Alloy Choke and MOSFET; certified by military-standard)</li> <li>- ASUS DIGI+ Power Control Utility</li> </ul> <p><b>“SAFE &amp; Stable!” Guardian Angel</b></p> <ul style="list-style-type: none"> <li>- Dust Defenders with connector covers and back I/O dust filter</li> <li>- TUF ESD Guards</li> <li>- MemOK!</li> </ul>

*(continued on the next page)*

## GRYPHON Z97 ARMOR EDITION specifications summary

<b>Rear Panel I/O Ports</b>	<ul style="list-style-type: none"> <li>1 x DVI-D port</li> <li>1 x HDMI port</li> <li>1 x DisplayPort</li> <li>1 x Optical S/PDIF Output</li> <li>1 x LAN (RJ45) port</li> <li>4 x USB 3.0/2.0 ports (blue)</li> <li>4 x USB 2.0/1.1 ports</li> <li>8-channel Audio I/O ports</li> </ul>
<b>Other Special Features</b>	<ul style="list-style-type: none"> <li>- USB 3.0 Boost featuring speedy USB 3.0 transmission</li> <li>- USB BIOS Flashback with USB BIOS Flashback Wizard for EZ BIOS download scheduling</li> <li>- USB Charger+ featuring quick-charging function for all smart devices</li> <li>- ASUS Remote GO! with Cloud GO! Remote Desktop, Remote Keyboard and Mouse, and File Transfer</li> <li>- ASUS UEFI BIOS EZ Mode featuring user-friendly graphics user interface</li> <li>- Turbo LAN to experience smooth online gaming with lower pings and less lags</li> <li>- Push Notice monitors your PC status with smart devices in real time</li> <li>- AI Suite 3</li> <li>- Ai Charger</li> <li>- ASUS Q-Connector</li> <li>- ASUS Q-Shield</li> <li>- ASUS Q-LED (CPU, DRAM, VGA, Boot Device LED)</li> <li>- ASUS Q-Slot</li> <li>- ASUS Q-DIMM</li> <li>- ASUS O.C. Profile</li> <li>- ASUS CrashFree BIOS 3</li> <li>- ASUS EZ Update</li> <li>- Disk Unlocker</li> <li>- ASUS EZ Flash 2</li> <li>- Multi-language BIOS</li> </ul>
<b>Support DVD contents</b>	<ul style="list-style-type: none"> <li>Drivers</li> <li>Anti-virus software (OEM version)</li> <li>ASUS/TUF CPU-Z</li> <li>ASUS Utilities</li> </ul>

*(continued on the next page)*

# GRYPHON Z97 ARMOR EDITION specifications summary

<p><b>Internal I/O connectors</b></p>	<p>1 x USB 3.0/2.0 connector supports additional 2 USB 3.0/2.0 ports (19-pin; moss green)                  2 x USB 2.0/1.1 connectors support additional 4 USB 2.0/1.1 ports                  6 x SATA 6Gb/s connectors (brown)                  1 x CPU Fan connector (4-pin moss green) for both 4-pin (PWM mode) and 3-pin (DC mode) CPU coolers control with auto detection support                  1 x CPU OPT Fan connector (4-pin Black) for both 4-pin(PWM mode) and 3-pin(DC mode) CPU coolers control                  4 x Chassis Fan connectors (4-pin Black) for both 4-pin(PWM mode) and 3-pin(DC mode) CPU coolers control                  2 x Assistant Fan connectors (1 x 3-pin, 1 x 4-pin [White])                  1 x Front panel audio connector(AAFP)                  1 x 24-pin EATX Power connector                  1 x 8-pin EATX 12V Power connector                  1 x System Panel (Q-Connector)                  1 x USB BIOS Flashback button                  1 x MemOK! Button                  1 x DRCT(DirectKey) header                  3 x T_Sensor (Thermal Sensor) headers                  1 x S/PDIF Out header                  1 x TPM header                  1 x Clear CMOS jumper</p>
<p><b>BIOS features</b></p>	<p>64 Mb Flash ROM, UEFI AMI BIOS, PnP, SM BIOS 2.7, ACPI 5.0, Multi-language BIOS, ASUS EZ Flash 2, ASUS CrashFree BIOS 3, My Favorites, Quick Note, Last Modified Log, F12 PrintScreen function, F3 Shortcut functions, and ASUS DRAM SPD (Serial Presence Detect) memory information</p>
<p><b>Manageability</b></p>	<p>Wfm 2.0, DMI 2.7, WOL by PME, PXE</p>
<p><b>Operating System Support</b></p>	<p>Windows® 8.1                  Windows® 8                  Windows® 7</p>

*(continued on the next page)*

# GRYPHON Z97 ARMOR EDITION specifications summary

<b>Accessories</b>	4 x Serial ATA 6Gb/s cables 1 x ASUS SLI bridge connector 7cm 1 x ASUS Q-Shield 1 x 2-in-1 Q-connector 1 x Assistant Fan (40mm) 1 x TUF Accessory Package - 3 x Thermistor cables - 1 x back I/O dust frame - 1 x back I/O dust grid - 1 x connector dust cover collection (On board USB 3.0, DVI, HDMI, DP, LAN) - 10 x USB connector dust covers (2 x On board, 8 x back) - 7 x SATA connector dust covers - 1 x SATA Express dust cover - 5 x Audio connector dust covers - 3 x PCIe x16 slot dust covers - 2 x DRAM slot dust covers - 1 x PCIe x1 slot dust cover - 2 x Short fan screws 1 x TUF Inside sticker 1 x TUF Certification card 1 x TUF 5-Year Warranty manual (by region) TUF Accessory Installation Guide User's manual
<b>Form factor</b>	µATX form factor: 9.6 in. x 9.6 in. (24.4 cm x 24.4 cm)



Specifications are subject to change without notice.

# Package contents

Check your motherboard package for the following items

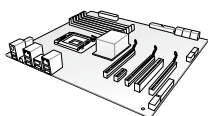

**ASUS GRYPHON Z97 ARMOR EDITION motherboard**



**Technical documentations, certification and warranty card**



**Support DVD**

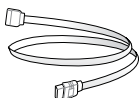

**4 x Serial ATA 6.0 Gb/s cables**

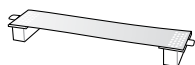

**1 x ASUS SLI™ bridge connector (7 cm)**

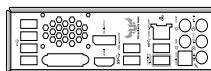

**1 x ASUS Q-Shield**

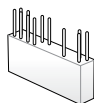

**1 x 2-in-1 ASUS Q-Connector kit**

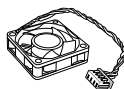

**1 x 40 mm Assistant fan**



**2 x short fan screws**

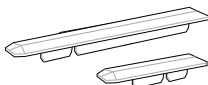

**3 x PCIe x16 slot covers  
1 x PCIe x1 slot covers**



**2 x DRAM slot covers**

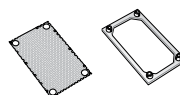

**Rear I/O dust filter**



**TUF Accessory Installation Guide**

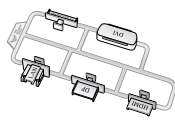

**1 x Connector cap set (LAN cap, HDMI cap, DVI cap, DP cap, Front USB 3.0 cap)**



**3 x Thermistor cables**



**7 x SATA connector caps  
1 x SATA Express connector cap  
8 x Back I/O USB 3.0/2.0 connector caps**



**2 x Onboard USB 2.0 connector caps**



**5 x Audio connector caps**



- If any of the above items is damaged or missing, contact your retailer.
- The illustrated items above are for reference only. Actual product specifications may vary with different models.

# Installation tools and components

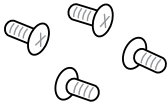

1 bag of screws



Philips (cross) screwdriver



PC chassis

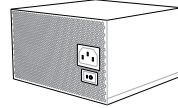

Power supply unit

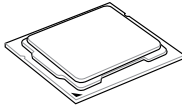

Intel® LGA1150 CPU

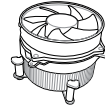

Intel® LGA1150 compatible CPU Fan

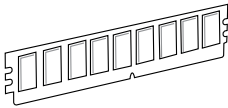

DIMM

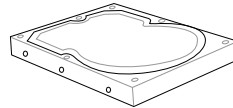

SATA hard disk drive

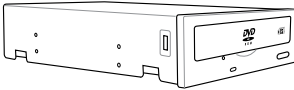

SATA optical disc drive (optional)

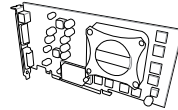

Graphics card (optional)



---

The tools and components in the table above are not included in the motherboard package.

---





# Product introduction

# 1

## 1.1 Special features

### 1.1.1 Product highlights

#### **LGA1150 socket for the 4th, New 4th, and 5th generation Intel® Core™ i7 / Intel® Core™ i5 / Intel® Core™ i3, Pentium®, and Celeron® processors**

This motherboard supports the 4th, New 4th, and 5th generation Intel® Core™ i7 / Intel® Core™ i5 / Intel® Core™ i3, Pentium®, and Celeron® processors in the LGA1150 package. It provides great graphics and system performance with its GPU, dual-channel DDR3 memory slots, and PCI Express 2.0/3.0 expansion slots.

#### **Intel® Z97 Express Chipset**

Intel® Z97 Express Chipset is a single chipset that supports the LGA1150 socket for the 4th, New 4th, and 5th generation Intel® Core™ i7/Intel® Core™ i5/Intel® Core™ i3, Pentium® and Celeron® processors. It utilizes the serial point-to-point links, which increases bandwidth and enhances the system's performance. It natively supports up to six USB 3.0 ports for up to ten times faster transfer rate than USB 2.0 and enables the iGPU function for Intel® integrated graphics performance.

#### **PCI Express® 3.0**

PCI Express® 3.0 (PCIe 3.0) is the PCI Express bus standard that provides twice the performance and speed of PCIe 2.0. It provides an optimal graphics performance, unprecedented data speed and seamless transition with its complete backward compatibility to PCIe 1.0/2.0 devices.

#### **Dual-Channel DDR3 1866 / 1600 / 1333 MHz Support**

The motherboard supports the dual-channel DDR3 memory that features data transfer rates of DDR3 1866 / 1600 / 1333 MHz to boost the system's performance, and to meet the higher bandwidth requirements of 3D graphics, multimedia and Internet applications.

#### **Quad-GPU SLI and Quad GPU CrossFireX™ Support**

This motherboard features the most powerful Intel® Z97 platform that optimizes PCIe allocation in multi-GPU SLI and CrossFireX™ solution, giving you a brand-new gaming enjoyment.

## Intel® Smart Response Technology

Intel® Smart Response Technology, an important part of Green ASUS eco-friendly computing, reduces load and wait time, eliminates unnecessary hard drive spin thus lowering power usage, and uses an installed SSD (requires 18.6 GB available space) as a cache for frequently accessed data or applications. It combines SSD performance and hard drive capacity, operating up to six times faster than a hard-drive-only system to boost the system's overall performance.

\* 4th Generation Intel® Core™ processors family support Intel® Smart Response Technology.

\*\* An operating system must be installed on the HDD to launch Intel® Smart Response Technology.

\*\*\* The SSD is reserved for caching function.

## Intel® Smart Connect Technology

Your computer can receive fresh updates for selected applications, even when the system is in sleep mode. This means less time waiting for applications to update and sync with the cloud, leading to a more efficient computing experience.

## Intel® Rapid Start Technology

Intel® Rapid Start Technology allows your computer to quickly resume from a low-power hibernate state in seconds. Saving your system memory to the designated SSD, it provides your computer a faster wake-up response time, while still keeping the energy use low.

## Complete USB 3.0 integration

This motherboard offers you the strategic USB 3.0 accessibility for both the front and rear panels, allowing you to experience the convenience of the latest plug and play connectivity solution of speed up to ten times faster than USB 2.0.

## 1.1.2 “Ultimate COOL” Thermal Solutions

### Thermal Radar 2

Thermal Radar 2 uses multiple sensors to control motherboard temperatures, automatically adjusting fan speeds for better system stability and power efficiency. It also provides customizable fan management that displays real-time motherboard, CPU and VGA zone cooling status, and promotes extended system longevity, power saving solution, and noise reduction.

### TUF ICe

ASUS TUF have forged a brand new microchip that delivers incredibly precise temperature monitoring and fan controls. With the TUF ICe, you can be assured that monitoring of onboard temperature sensors and fan speeds is always ultra-accurate—whether you are adjusting settings manually or using the automatic one-click organization.

### Thermal Armor

The GRYPHON Z97 ARMOR EDITION Thermal Armor features the reversible-airflow technology that blows dust up and away from the heatsink VRM. The Thermal Armor's airflow channels provides strategic cooling for critical components. It also has PCB convection holes that improves air circulation and effective cooling.

### 1.1.3 “TUF Engine” Power Design

#### **DIGI+ Power Control**

ASUS DIGI+ Power Control features the revolutionary and innovative digital VRM, DRAM, and CPU Voltage controllers. These controllers offers ultra-precise memory and voltage tuning for optimal system efficiency, stability and performance.

#### **TUF Components (TUF new Alloy Chokes, TUF 10K Ti-Caps, and TUF MOSFET; certified by military-standard)**

The motherboard’s TUF components features improved military-standard robust TUF new alloy chokes, titanium solid state capacitors, and MOSFETs. The TUF alloy choke is 13.6% cooler for extra unbeatable durability. Its 10K Titanium capacitors has 20% more temperature tolerance and provides five times longer lifetime usage while the military grade certified TUF MOSFETs offers lower RDS (on).

### 1.1.4 “Safe & Stable!” Guardian Angel

#### **TUF Fortifier**

The metal base TUF Fortifier strengthens the base of the motherboard and secures the Thermal Armor and the motherboard in place. It reinforces the motherboard’s PCB to support the Thermal Armor, CPU, VGA card, additional expansion cards, and other peripherals. It also makes the motherboard easier to handle and helps protect your hands.

#### **Dust Defender**

Dust Defender provides rear I/O filter and special shields that help reduce dust build-up on critical points within slots and connectors, minimizing any harm to the components’ optimal functions, data transfer efficiency, and system performance.

#### **TUF ESD Guards**

TUF ESD (Electrostatic Discharge) Guards provides protection against electrostatic discharges, which can damage the motherboard’s components. The ASUS exclusive Anti-Static chip and circuit design, and the I/O shield provide four times better protection and ensure the motherboard’s lifespan.

#### **MemOK!**

MemOK!, the remarkable memory rescue tool, allows you to simply press a button to patch memory issues, ensure memory boot compatibility, determine fail-safe settings, and dramatically improve the system’s bootup.

## 1.1.5 ASUS EZ DIY

### ASUS UEFI BIOS (EZ Mode)

ASUS UEFI BIOS, a UEFI compliant architecture, offers the first mouse-controlled intuitive graphical BIOS interface that goes beyond the traditional keyboard-only BIOS controls, providing you with more flexibility, convenience, and easy to navigate UEFI BIOS than the traditional BIOS versions. It offers you with dual selectable modes and native support for hard drives larger than 2.2 TB.

ASUS UEFI BIOS includes the following new features:

- New My Favorites function allows you to quickly access the frequently used items
- New quick Note function allows you to take notes in the BIOS environment
- New Last Modified log allows you to view all your modified settings
- F12 BIOS snapshot hotkey
- F3 Shortcut for most accessed information
- ASUS DRAM SPD (Serial Presence Detect) information detecting faulty DIMMs, and helping with difficult POST situations.

### ASUS Q-Design

ASUS q-Design enhances your DIY experience. All of q-Slot and q-Shield design speed up and simplify the DIY process.

### ASUS Q-shield

ASUS Q-Shield's special design makes it convenient and easy to install on your motherboard. With better electric conductivity, it ideally protects your motherboard against static electricity and shields it against EMI (Electronic Magnetic Interference).

### ASUS Q-connector

ASUS q-Connector is a unique adapter that allows you to easily connect or disconnect the chassis front panel cables to one module, eliminating the hassle of plugging one cable at a time and making the connection quick and accurate.

## 1.1.6 ASUS Exclusive Features

### Remote GO!

ASUS Remote GO! leads the way to a more enjoyable home entertainment. With ASUS Remote GO!, you can wirelessly stream media files to DLNA devices, remotely control and access your computer using your smart device and easily transfer files between your computer and smart device.

Conveniently use and enjoy these ASUS Remote GO! functions:

- **Cloud GO!:** Allows you to control files and sync them all across cloud services in a few clicks.
- **ASUS Media Streamer:** Allows you to stream media files to a DLNA-supported devices.
- **Remote Desktop:** Allows you to view your computer's desktop and remotely operate your computer in real-time from your smart device.
- **File Transfer:** Allows you to transfer files between your computer and smart device.

### USB 3.0 Boost

ASUS USB 3.0 Boost, which supports USB 3.0 standard UASP (USB Attached SCSI Protocol), significantly increases a USB device's transfer speed up to 170% faster than the already impressive USB 3.0 transfer speed. It automatically accelerates data speeds for compatible USB 3.0 peripherals without the need for any user interaction.

### USB Charger+

With a dedicated onboard controller, quick-charge all your smart devices such as smartphones, tablets and more, all up to three times faster, even when the system is powered off, in sleep or hibernation mode.

### USB BIOS Flashback

USB BIOS Flashback offers a hassle-free updating solution for your ultimate convenience. Install a USB storage device containing the BIOS file, press the BIOS Flashback button for about three seconds, and the UEFI BIOS is automatically updated even without entering the existing BIOS or operating system. It also allows you to regularly check for UEFI BIOS updates, and download the latest BIOS automatically.

### AI Suite 3

With its user-friendly interface, ASUS AI Suite 3 consolidates all the exclusive ASUS features into one simple-to-use software package. It allows you to supervise fan speed control, voltage and sensor readings. This all-in-one software offers diverse and ease to use functions, with no need to switch back and forth between different utilities.

## 1.1.7 Other special features

### DisplayPort Support

DisplayPort is a digital display interface standard that delivers up to 10.8 Gbps of bandwidth over standard cables, providing billions of colors and bi-directional communications, thus enabling the fastest refresh rates, and the highest resolution digital display through a single cable. Also, it supports HDCP copy protection for Blu-ray discs. Simply output 3D signals through the connected DisplayPort cable with your 3D display, then you can sit back and enjoy a perfect 3D animation experience.

### HDMI Support

High Definition Multimedia Surface (HDMI) is a set of digital video standards that delivers multi-channel audio and uncompressed digital video up to 4K/2K resolution visuals through a single cable. Supporting HDCP copy protection such as HD DVD and blu-ray discs, HDMI provides you with the highest quality home theater experience.

### ErP Ready

The motherboard is European Union's Energy-related Products (ErP) ready, and ErP requires products to meet certain energy efficiency requirement in regards to energy consumptions. This is in line with ASUS vision of creating environment-friendly and energy-efficient products through product design and innovation to reduce carbon footprint of the product and thus mitigate environmental impacts.

## 1.2 Motherboard overview

### 1.2.1 Before you proceed

Take note of the following precautions before you install motherboard components or change any motherboard settings.



- 
- Unplug the power cord from the wall socket before touching any component.
  - Before handling components, use a grounded wrist strap or touch a safely grounded object or a metal object, such as the power supply case, to avoid damaging them due to static electricity.
  - Hold components by the edges to avoid touching the ICs on them.
  - Whenever you uninstall any component, place it on a grounded antistatic pad or in the bag that came with the component.
  - Before you install or remove any component, ensure that the ATX power supply is switched off or the power cord is detached from the power supply. Failure to do so may cause severe damage to the motherboard, peripherals, or components.
-

## 1.2.2 Motherboard layout

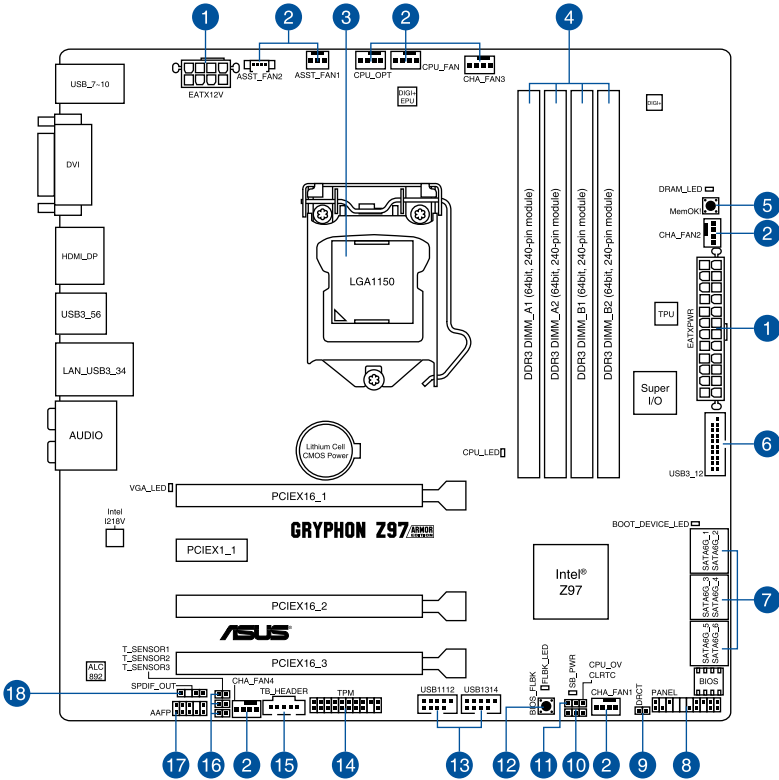

Refer to the **Internal connectors** and **Rear I/O connection** section for more information about rear panel connectors and internal connectors.



## Layout contents

Connectors/Jumpers/Slots	Page
1. ATX power connectors (24-pin EATXPWR, 8-pin EATX12V)	1-36
2. CPU, optional, chassis, and assistant fan connectors (4-pin CPU_FAN; 4-pin CPU_OPT; 4-pin CHA_FAN1-4; 3-pin ASST_FAN1, 4-pin ASST_FAN2)	1-34
3. LGA1150 CPU socket	1-10
4. DDR3 DIMM slots	1-11
5. MemOK! button	1-25
6. USB 3.0 connector (20-1 pin USB3_12)	1-31
7. Intel® Z97 Serial ATA 6.0 Gb/s connectors (7-pin SATA6G_1-6 [brown])	1-30
8. System panel connector (20-8 pin PANEL)	1-37
9. DirectKey connector (2-pin DRCT)	1-38
10. Clear RTC RAM (3-pin CLRRTC)	1-27
11. CPU Over Voltage jumper (3-pin CPU_OV)	1-28
12. BIOS Flashback button (BIOS_FLBK)	1-26
13. USB 2.0 connectors (10-1 pin USB1112, USB1314)	1-33
14. TPM connector (20-1 pin TPM)	1-38
15. Thunderbolt header (5-pin TB_HEADER)	1-39
16. Thermal sensor connectors (T_SENSOR1, T_SENSOR2, T_SENSOR3)	1-35
17. Front panel audio connector (10-1 pin AAFP)	1-35
18. Digital audio connector (4-1 pin SPDIF_OUT)	1-32

## 1.2.3 Central Processing Unit (CPU)

The motherboard comes with a surface mount LGA1150 socket designed for the 4th, New 4th, and 5th generation Intel® Core™ i7 / Intel® Core™ i5 / Intel® Core™ i3, Pentium® and Celeron® processors.

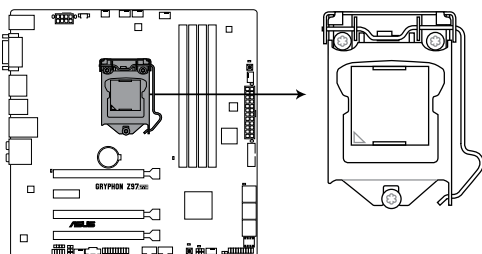

**GRYPHON Z97 ARMOR EDITION CPU LGA1150**



- Ensure that all power cables are unplugged before installing the CPU.
- Ensure that you install the correct CPU designed for LGA1150 only. DO NOT install a CPU designed for LGA1155 and LGA1156 sockets on the LGA1150 socket.
- Upon purchase of the motherboard, ensure that the PnP cap is on the socket and the socket contacts are not bent. Contact your retailer immediately if the PnP cap is missing, or if you see any damage to the PnP cap/socket contacts/motherboard components. ASUS will shoulder the cost of repair only if the damage is shipment/transit-related.
- Keep the cap after installing the motherboard. ASUS will process Return Merchandise Authorization (RMA) requests only if the motherboard comes with the cap on the LGA1150 socket.
- The product warranty does not cover damage to the socket contacts resulting from incorrect CPU installation/removal, or misplacement/loss/incorrect removal of the PnP cap.

## 1.2.4 System memory

The motherboard comes with four Double Data Rate 3 (DDR3) Dual Inline Memory Modules (DIMM) slots.



A DDR3 module is notched differently from a DDR or DDR2 module. DO NOT install a DDR or DDR2 memory module to the DDR3 slot.

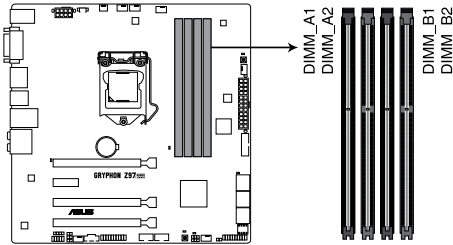

GRYPHON Z97 ARMOR EDITION 240-pin DDR3 DIMM socket

### Recommended memory configurations

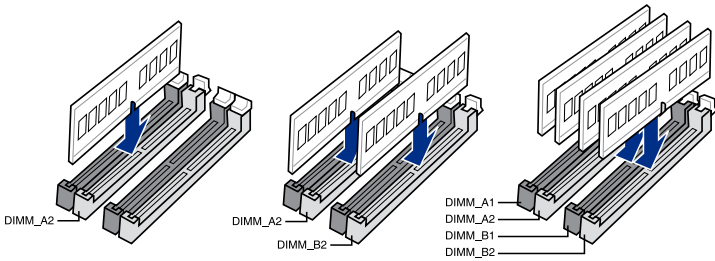

## Memory configurations

You may install 2GB, 4GB and 8GB unbuffered and non-ECC DDR3 DIMMs into the DIMM sockets.



- 
- You may install varying memory sizes in Channel A and Channel B. The system maps the total size of the lower-sized channel for the dual-channel configuration. Any excess memory from the higher-sized channel is then mapped for single-channel operation.
  - According to Intel® CPU spec, DIMM voltage below 1.65V is recommended to protect the CPU.
  - Always install DIMMs with the same CAS latency. For optimum compatibility, we recommend that you obtain memory modules from the same vendor.
  - Due to the memory address limitation on 32-bit Windows® OS, when you install 4 GB or more memory on the motherboard, the actual usable memory for the OS can be about 3 GB or less. For effective use of memory, we recommend that you do any of the following:
    - Use a maximum of 3GB system memory if you are using a 32-bit Windows® OS.
    - Install a 64-bit Windows® OS when you want to install 4GB or more on the motherboard.
    - For more details, refer to the Microsoft® support site at <http://support.microsoft.com/kb/929605/en-us>.
  - This motherboard does not support DIMMs made up of 512 Mb (64 MB) chips or less (Memory chip capacity counts in Megabit, 8 Megabit/Mb = 1 Megabyte/MB).



- 
- The default memory operation frequency is dependent on its Serial Presence Detect (SPD), which is the standard way of accessing information from a memory module. Under the default state, some memory modules for overclocking may operate at a lower frequency than the vendor-marked value. To operate at the vendor-marked or at a higher frequency, refer to section **Ai Tweaker menu** for manual memory frequency adjustment.
  - For system stability, use a more efficient memory cooling system to support a full memory load (4 DIMMs) or overclocking condition.
  - Memory modules with memory frequency higher than 2133MHz and their corresponding timing or the loaded XMP profile is not the JEDEC memory standard. The stability and compatibility of the memory modules depend on the CPU's capabilities and other installed devices.
-

## GRYPHON Z97 ARMOR EDITION Motherboard Qualified Vendors Lists (QVL)

### DDR3 2666 MHz capability

Vendors	Part No.	Size	SS/ DS	Chip Brand	Chip NO.	Timing	Voltage	DIMM socket support (Optional)	
								2	4
Apacer	78.BAGFF.AFC0C(XMP)	8GB (2x 4GB )	DS	-	-	12-13-13-35	-	•	•
Apacer	78.BAGFR.AFD0C(XMP)	8GB (2x 4GB )	DS	-	-	12-13-13-35	-	•	•
Apacer	78.CAGFF.AFD0C(XMP)	16GB (2x 8GB )	DS	-	-	12-13-13-35	-	•	•
CORSAIR	CMD16GX3M4A2666C11 (Ver5.12)(XMP)	16GB (4x 4GB )	DS	-	-	11-13-13-35	1.65	•	•
G.SKILL	F3-2666CL10Q- 16GBZHD(XMP)	16GB (4x 4GB )	DS	-	-	10-12-12-31	1.65	•	•
GEIL	GOC332GB2666C11QC(XMP)	32GB (4x 8GB )	DS	-	-	11-13-13-32	1.65	•	•
KINGSTON	KHX26C11T2K2/8X(XMP)	8GB (2x 4GB )	SS	-	-	2666-11-13- 13-32	1.65	•	

### DDR3 2500 MHz capability

Vendors	Part No.	Size	SS/ DS	Chip Brand	Chip NO.	Timing	Voltage	DIMM socket support (Optional)	
								2	4
G.SKILL	F3-2000CL10Q- 16GBZHD(XMP)	16GB ( 4x 4GB )	DS	-	-	10-11-11-31	1.65	•	•

### DDR3 2400 MHz capability

Vendors	Part No.	Size	SS/ DS	Chip Brand	Chip NO.	Timing	Voltage	DIMM socket support (Optional)	
								2	4
A-DATA	AX3U2400W4G11-DMV(XMP)	8GB ( 2x 4GB )	SS	-	-	11-13-13-35	1.65	•	•
A-DATA	AX3U2400W8G11-DMV(XMP)	16GB ( 2x 8GB )	DS	-	-	11-13-13-35	1.65	•	•
Apacer	78.BAGFL.AFD0C(XMP)	8GB ( 2x 4GB )	DS	-	-	11-12-12-30	-	•	•
Apacer	783BAGF3.AFD0C(XMP)	8GB ( 2x 4GB )	DS	-	-	11-11-11-30	-	•	•
CORSAIR	CMD16GX3M2A2400C10 (Ver4.21)(XMP)	16GB ( 2x 8GB )	DS	-	-	10-12-12-31	1.65	•	•
CORSAIR	CMD32GX3M4A2400C10 (Ver5.29)(XMP)	32GB ( 4x 8GB )	DS	-	-	10-12-12-31	1.65	•	•
CORSAIR	CMY16GX3M2A2400C10A (Ver4.21)(XMP)	16GB ( 8x 2GB )	DS	-	-	10-12-12-31	1.65	•	•
CORSAIR	CMY16GX3M2A2400C10R (Ver4.21)(XMP)	16GB ( 2x 8GB )	DS	-	-	10-12-12-31	1.65	•	•
CORSAIR	CMZ16GX3M2A2400C10 (Ver4.21)	16GB ( 2x 8GB )	DS	-	-	10-12-12-31	1.65	•	•

(continued on the next page)

## DDR3 2400 MHz capability

Vendors	Part No.	Size	SS/ DS	Chip Brand	Chip NO.	Timing	Voltage	DIMM socket support (Optional)	
								2	4
G.SKILL	F3-19200CL10Q-32GBZHDXMP)	32GB ( 4x 8GB )	DS	-	-	10-12-12-31	1.65	•	
G.SKILL	F3-19200CL11Q-16GBZHDXMP)	16GB ( 4x 4GB )	DS	-	-	11-11-11-31	1.65	•	•
G.SKILL	F3-19200CL9D-4GBPIS(XMP)	4G ( 2x 2G )	DS	-	-	9-11-9-28	1.65	•	
G.SKILL	F3-19200CL9Q-16GBZMD(XMP)	16GB ( 4x 4GB )	DS	-	-	9-11-11-31	1.65	•	•
G.SKILL	F3-2400C11Q-32GXM(XMP)	32GB ( 4x 8GB )	DS	-	-	11-13-13-31	1.65	•	•
GEIL	GOC316GB2400C10QC(XMP)	16GB ( 4x 4GB )	DS	-	-	10-11-11-30	1.65	•	•
GEIL	GOC316GB2400C11QC(XMP)	16GB ( 4x 4GB )	DS	-	-	11-11-11-30	1.65	•	•
Kingston	KHX2400C11D3K4/8GX(XMP)	8GB ( 4x 2GB )	SS	-	-	11-13-11-30	1.65	•	•
KINGSTON	KHX24C11K4/16X(XMP)	16GB ( 4x 4GB )	DS	-	-	11-13-13-30	1.65	•	•
KINGSTON	KHX24C11T2K2/8X(XMP)	8GB ( 2x 4GB )	DS	-	-	-	1.65	•	•
KINGSTON	KHX24C11T3K2/16X(XMP)	16GB ( 2x 8GB )	DS	-	-	2400-11-13-13-32	1.65	•	
KINGSTON	KHX24C11T3K4(XMP)	16GB ( 4x 4GB )	DS	-	-	2400-11-13-13-30	1.65	•	•
KINGSTON	KHX24C11T3K4/32X(XMP)	32GB ( 4x 8GB )	DS	-	-	9-9-9-24	1.65	•	•
Mushkin	997122R(XMP)	16GB ( 2x 8GB )	DS	-	-	2400-10-12-12-28	1.65	•	•
Silicon Power	SP004GXLJU240NSA(XMP)	4GB	SS	-	-	2400-11-13-13-32	-	•	•
Transcend	TX2400KLN-8GK(XMP)	8GB ( 2x 4GB )	DS	-	-	2400-11-12-11-29	1.6	•	•

## DDR3 2200 MHz capability

Vendors	Part No.	Size	SS/ DS	Chip Brand	Chip NO.	Timing	Voltage	DIMM socket support (Optional)	
								2	4
GEIL	GET34GB2200C9DC(XMP)	4GB ( 2x 2GB )	DS	-	-	9-10-9-28	1.65	•	•
GEIL	GET38GB2200C9ADC(XMP)	8GB ( 2x 4GB )	DS	-	-	9-11-9-28	1.65	•	•

## DDR3 2133 MHz capability

Vendors	Part No.	Size	SS/ DS	Chip Brand	Chip NO.	Timing	Voltage	DIMM socket support (Optional)	
								2	4
A-DATA	AX3U2133W4G10-DR(XMP)	8GB (2x 4GB)	SS	-	-	10-11-11-30	1.65	•	•
A-DATA	AX3U2133W8G10-DR(XMP)	16GB (2x 8GB)	DS	-	-	10-11-11-30	1.65	•	•
Apacer	78.BAGE4.AFD0C(XMP)	8GB (2x 4GB)	DS	-	-	9-9-9-24	-	•	•
Apacer	AHU04GFB33CAQ3R(XMP)	4GB	DS	-	-	11-13-13-31	-	•	•
CORSAIR	CMD16GX3M2A2133C9 (Ver4.21)(XMP)	16GB (2x 8GB)	DS	-	-	9-11-11-31	1.65	•	•
CORSAIR	CMD32GX3M4A2133C9 (Ver4.21)(XMP)	32GB (4x 8GB)	DS	-	-	9-11-11-31	1.65	•	•
CORSAIR	CMD8GX3M2A2133C9 (Ver1.5)(XMP)	8GB (2x 4GB)	DS	-	-	9-11-10-27	1.5	•	•
CORSAIR	CMD8GX3M2B2133C9 (Ver5.12)(XMP)	8GB (2x 4GB)	DS	-	-	9-11-11-31	1.65	•	•
CORSAIR	CMY8GX3M2A2133C11R (Ver4.21)(XMP)	8GB (2x 4GB)	DS	-	-	11-11-11-27	1.5	•	•
CORSAIR	CMZ8GX3M2A2133C11R (Ver4.21)(XMP)	8GB (2x 4GB)	DS	-	-	11-11-11-27	1.5	•	•
G.SKILL	F3-1700CL11Q2- 64GBZLD(XMP)	64GB (8x 8GB)	DS	-	-	11-11-11-30	1.5	•	•
G.SKILL	F3-1700CL9Q-16GBZH(XMP)	16GB (4x 4GB)	DS	-	-	9-11-10-28	1.65	•	•
G.SKILL	F3-2133C10Q-32GSR(XMP)	32GB (4x 8GB)	DS	-	-	10-12-12-31	1.5	•	•
G.SKILL	F3-2133C11Q-32GZL(XMP)	32GB (4x 8GB)	DS	-	-	11-11-11-31	1.5	•	•
KINGSTON	KHX2133C11D3K4/16GX(XMP)	16GB (4x 4GB)	DS	-	-	11-12-11-30	1.65	•	•
KINGSTON	KHX21C11T3FK8/64X(XMP)	64GB (8x 8GB)	DS	-	-	9-9-9-24	1.5	•	•
Silicon Power	SP004GXLYU213NSA(XMP)	4GB	SS	-	-	2133-11-12- 11-30	-	•	•
Silicon Power	SP008GXLYU213NSA(XMP)	8GB	DS	-	-	2133-11-12- 11-30	-	•	•
Transcend	TX2133KLH-16GK(XMP)	16GB (2x 8GB)	DS	-	-	2133-10-11- 10-27	1.6	•	•
Transcend	TX2133KLN-8GK(XMP)	8GB (2x 4GB)	DS	-	-	2133-10-11- 10-27	1.6	•	•

## DDR3 2000 MHz capability

Vendors	Part No.	Size	SS/ DS	Chip Brand	Chip NO.	Timing	Voltage	DIMM socket support (Optional)	
								2	4
AEXEA	AXA3ES4GK2000L.G28V(XMP)	4GB (2x 2GB)	DS	-	-	-	1.65	•	•
Asint	SLA302G08-ML2HB(XMP)	4GB	DS	Hynix	H5TQ2G83BFRH9C	9-9-9-27	-	•	•
GEIL	GUP34GB2000C9DC(XMP)	4GB (2x 2GB)	DS	-	-	9-9-9-28	1.65	•	•

## DDR3 1866 MHz capability

Vendors	Part No.	Size	SS/DS	Chip Brand	Chip NO.	Timing	Voltage	DIMM socket support (Optional)	
								2	4
CORSAIR	CMD16GX3M2A1866C9 (Ver5.29) (XMP)	16GB ( 2x 8GB )	DS	-	-	1866-9-9-9-27	1.5	•	
CORSAIR	CMD16GX3M4A1866C9 (Ver4.13) (XMP)	16GB ( 4x 4GB )	DS	-	-	9-10-9-27	1.5	•	•
CORSAIR	CMD16GX3M4A1866C9 (Ver8.16) (XMP)	16GB ( 4x 4GB )	DS	-	-	9-10-9-27	1.5	•	•
CORSAIR	CMD32GX3M4A1866C9 (Ver3.24) (XMP)	32GB ( 4x 8GB )	DS	-	-	9-10-9-27	1.5	•	•
CORSAIR	CMD8GX3M2A1866C9 (Ver4.13) (XMP)	8GB ( 2x 4GB )	DS	-	-	-	1.5	•	•
CORSAIR	CMD8GX3M2A1866C9 (Ver5.12) (XMP)	8GB ( 2x 4GB )	DS	-	-	9-10-9-27	1.5	•	
CORSAIR	CMD8GX3M2A1866C9 (Ver8.16) (XMP)	8GB ( 2x 4GB )	DS	-	-	9-10-9-27	1.5	•	
CORSAIR	CMT32GX3M4X1866C9(Ver3.23) (XMP)	32GB ( 4x 8GB )	DS	-	-	9-10-9-27	1.5	•	•
CORSAIR	CMY16GX3M2A1866C9 (Ver 4.21) (XMP)	16GB ( 2x 8GB )	DS	-	-	9-10-9-27	1.5	•	•
CORSAIR	CMY8GX3M2A1866C9 (Ver3.24) (XMP)	8GB ( 2x 4GB )	DS	-	-	9-10-9-27	1.5	•	•
CORSAIR	CMZ16GX3M2A1866C10 (Ver5.29) (XMP)	16GB ( 2x 8GB )	DS	-	-	10-11-10-30	1.5	•	•
CORSAIR	CMZ16GX3M2A1866C9(XMP)	16GB ( 2x 8GB )	DS	-	-	1866-9-10-9-27	1.5	•	•
CORSAIR	CMZ32GX3M4X1866C10 (Ver3.23) (XMP)	32GB ( 4x 8GB )	DS	-	-	10-11-10-27	1.5	•	•
CORSAIR	CMZ32GX3M4X1866C10(Ver3.23) (XMP)	32GB ( 4x 8GB )	DS	-	-	10-11-10-27	1.5	•	•
CORSAIR	CMZ8GX3M2A1866C9 (Ver8.16) (XMP)	8GB ( 2x 4GB )	DS	-	-	9-10-9-27	1.5	•	•
CORSAIR	CMZ8GX3M2A1866C9(XMP)	8GB ( 2x 4GB )	DS	-	-	9-10-9-27	1.5	•	
CORSAIR	CMZ8GX3M2A1866C9G (Ver5.12) (XMP)	8GB ( 2x 4GB )	DS	-	-	1866-9-10-9-27	1.5	•	•
Crucial	BLE8G3D1869DE1TX0.16FED(XMP)	16GB ( 2x 8GB )	DS	-	-	1866-9-9-9-27	1.5	•	•
Crucial	BLE4G3D1869DE1XT0.16FMD(XMP)	4GB	DS	-	-	9-9-9-27	1.5	•	•

(continued on the next page)



## DDR3 1866 MHz capability

Vendors	Part No.	Size	SS/ DS	Chip Brand	Chip NO.	Timing	Voltage	DIMM socket support (Optional)	
								2	4
G.SKILL	F3-14900CL10Q-32GBZL(XMP)	32GB ( 4x 8GB )	DS	-	-	10-11-10-30	1.5	•	•
G.SKILL	F3-14900CL9D-8GBSR(XMP)	8GB ( 2x 4GB )	DS	-	-	9-10-9-28	1.5	•	•
G.SKILL	F3-14900CL9Q-16GBXL(XMP)	16GB ( 4x 4GB )	DS	-	-	9-10-9-28	1.5	•	•
G.SKILL	F3-14900CL9Q-16GBZL(XMP)	16GB ( 4x 4GB )	DS	-	-	9-10-9-28	1.5	•	•
G.SKILL	F3-14900CL9Q-16GBZL(XMP)	16GB ( 4x 4GB )	DS	-	-	9-10-9-28	1.5	•	•
G.SKILL	F3-1866C10Q2-64GZM(XMP)	64GB ( 2x 8GB )	DS	-	-	10-11-10-30	1.5	•	•
G.SKILL	F3-1866C10Q2-64GZM(XMP)	64GB ( 2x 8GB )	DS	-	-	10-11-10-30	1.5	•	•
G.SKILL	F3-1866C9Q-32GXM(XMP)	32GB ( 4x 8GB )	DS	-	-	9-10-9-28	1.5	•	•
GEIL	GEEL316GB1866C9DC(XMP)	16GB ( 2x 8GB )	DS	-	-	1866-9-10- 9-28	1.65	•	•
KINGSTON	KHX1866C9D3K2/8GX(XMP)	8GB ( 2x 4GB )	DS	-	-	-	1.65	•	•
Silicon Power	SP004GXLYU186NSA(XMP)	4GB	SS	-	-	1866-9-11- 9-27	-	•	•
Silicon Power	SP008GXLYU186NSA(XMP)	8GB	DS	-	-	1866-9-11- 9-27	-	•	•

## DDR3 1600 MHz capability

Vendors	Part No.	Size	SS/ DS	Chip Brand	Chip NO.	Timing	Voltage	DIMM socket support (Optional)	
								2	4
A-DATA	AD3U1600W4G11	4GB	SS	A-DATA	3WCD-1211A	11-11-11-28	-	•	•
A-DATA	AD3U1600W8G11	8GB	DS	A-DATA	3WCD-1211A	11-11-11-28	-	•	•
A-DATA	ADDU1600W4G11-B	4GB	SS	A-DATA	DWND-1211A	9-9-9-24	-	•	•
A-DATA	ADDU1600W8G11-B	8GB	DS	ELPIDA	J4208EBBG- GN-F	9-9-9-24	-	•	•
A-DATA	AX3U1600W4G9- DB(XMP)	8GB ( 2x 4GB )	SS	-	-	9-9-9-24	1.5	•	•
A-DATA	AX3U1600W8G9- DB(XMP)	16GB ( 2x 8GB )	DS	-	-	9-9-9-24	1.5	•	•
AMD	AE32G1609U1-U	2GB	SS	AMD	23EY4587MB6H	-	1.5	•	•
AMD	AE34G1609U2-U	4GB	DS	AMD	23EY4587MB6H	-	1.5	•	•
AMD	AP38G1608U2K(XMP)	8GB ( 2x 4GB )	DS	-	-	9-9-9-28	1.65	•	•

(continued on the next page)

## DDR3 1600 MHz capability

Vendors	Part No.	Size	SS/DS	Chip Brand	Chip NO.	Timing	Voltage	DIMM socket support (Optional)	
								2	4
Apacer	78.B1GE3.9L10C	4GB	DS	Apacer	AM5D5908DEQSK	-	1.65	•	•
Apacer	78.B1GET.9K00C	4GB	SS	Apacer	AM5D6008BQQSK	11-11-11-28	-	•	•
Apacer	78.C1GET.9K10C	8GB	DS	Apacer	AM5D6008BQQSK	11-11-11-31	-	•	•
Apacer	AHU04GFA60C9Q3R(XMP)	4GB	DS	-	-	11-11-11-28	-	•	•
Apacer	AHU08GFA60CBT3R(XMP)	8GB	DS	-	-	9-9-9-24	-	•	•
Asint	SLA302G08-EGG1C(XMP)	4GB	DS	Asint	302G08-GG1C	9-9-9-27	-	•	•
Asint	SLA302G08-EGJ1C(XMP)	4GB	DS	Asint	302G08-GJ1C	9-9-9-27	-	•	•
Asint	SLA302G08-EGN1C	4GB	DS	ASint	302G08-GN1C	-	-	•	•
Asint	SLA304G08-ENG1B	4GB	SS	Asint	304G08-GN1B	9-11-11-28	-	•	•
Asint	SLB304G08-EGJ1B(XMP)	8GB	DS	-	-	9-9-9-27	-	•	•
Asint	SLB304G08-EGN1B	8GB	DS	ASint	304G08-GN1B	-	-	•	•
Asint	SLZ302G08-EGN1C	2GB	SS	ASint	302G08-GN1C	-	-	•	•
AVEXIR	AVD3U16000904G-2CW(XMP)	8GB ( 2x 4GB )	DS	-	-	11-11-11-28	1.5	•	•
CORSAIR	CMD16GX3M2A1600C9 (Ver8.21)(XMP)	16GB ( 2x 8GB )	DS	-	-	9-9-9-24	1.5	•	•
CORSAIR	CMD8GX3M2A1600C8 (Ver5.12)(XMP)	8GB ( 2x 4GB )	DS	-	-	1600 8-8-8-24	1.5	•	•
CORSAIR	CMD8GX3M2A1600C9 (Ver2.12)(XMP)	8GB ( 2x 4GB )	DS	-	-	9-9-9-24	1.5	•	•
CORSAIR	CML16GX3M2A1600C10 (Ver2.21)(XMP)	16GB ( 2x 8GB )	DS	-	-	10-10-10-27	1.5	•	•
CORSAIR	CML8GX3M2A1600C9 (Ver7.12)(XMP)	8GB ( 2x 4GB )	DS	-	-	9-9-9-24	1.5	•	•
CORSAIR	CMV8GX3M1A1600C11	8GB	DS	-	-	11-11-11-30	-	•	•
CORSAIR	CMX8GX3M2A1600C9 (Ver3.19)(XMP)	8GB ( 2x 4GB )	SS	-	-	9-9-9-24	1.65	•	•
CORSAIR	CMZ16GX3M2A1600C10 (Ver.3.24)(XMP)	16GB ( 2x 8GB )	DS	-	-	10-10-10-27	1.5	•	•
CORSAIR	CMZ16GX3M4A1600C9(XMP)	16GB ( 4x 4GB )	DS	-	-	9-9-9-24	1.5	•	•
CORSAIR	CMZ16GX3M4X1600C9 (Ver8.16)(XMP)	16GB ( 4x 4GB )	DS	-	-	1600-9-9-9-24	1.5	•	•
CORSAIR	CMZ32GX3M4X1600C10 (Ver2.2)(XMP)	32GB ( 4x 8GB )	DS	-	-	10-10-10-27	1.5	•	•
CORSAIR	CMZ4GX3M1A1600C9 (Ver8.16)(XMP)	4GB ( 1x 4GB )	DS	-	-	9-9-9-24	1.5	•	•
CORSAIR	CMZ8GX3M1A1600C10 (Ver3.23)(XMP)	8GB ( 1x 8GB )	DS	-	-	10-10-10-27	1.5	•	•
CORSAIR	CMZ8GX3M1A1600C10 (Ver8.21)(XMP)	8GB ( 1x 8GB )	DS	-	-	10-10-10-27	1.5	•	•
CORSAIR	CMZ8GX3M2A1600C8(XMP)	8GB ( 2x 4GB )	DS	-	-	8-8-8-24	1.5	•	•

(continued on the next page)

## DDR3 1600 MHz capability

Vendors	Part No.	Size	SS/ DS	Chip Brand	Chip NO.	Timing	Voltage	DIMM socket support (Optional)	
								2	4
Crucial	BLS4G3D1609DS1S00 .16FMR(XMP)	4GB	DS	-	-	1600-9- 9-9-24	1.5	•	•
Crucial	BLT4G3D1608DT1TX0 .16FM(XMP)	4GB	DS	-	-	8-8-8-24	1.5	•	•
Elixir	M2X2G64CB88G7N- DG(XMP)	2GB	SS	Elixir	N2CB2G80GN-DG	9-9-9-28	-	•	•
Elixir	M2X4G64CB8HG5N- DG(XMP)	4GB	DS	Elixir	N2CB2G80GN-DG	9-9-9-28	-	•	•
G.SKILL	F3-12800CL9D- 8GBSR2(XMP)	8GB (2x 4GB)	DS	-	-	9-9-9-24	1.25	•	•
G.SKILL	F3-12800CL9Q- 16GBXL(XMP)	16GB (4x 4GB)	DS	-	-	9-9-9-24	1.5	•	•
G.Skill	F3-12800CL9Q- 16GBZL(XMP)	16GB (4x 4GB)	DS	-	-	9-9-9-24	1.5	•	•
G.SKILL	F3-1600C9C-32GXM(XMP)	32GB (4x 8GB)	DS	-	-	-	1.5	•	•
GEIL	GUP34GB1600C7DC(XMP)	4GB (2x 2GB)	DS	-	-	7-7-7-24	1.6	•	•
KINGMAX	FLGE85F-C8KL9A(XMP)	2GB	SS	KINGMAX	N/A	9-9-9-28	-	•	•
KINGMAX	FLGF65F-C8KL9A(XMP)	4GB	DS	KINGMAX	N/A	9-9-9-28	-	•	•
KINGSTON	KHX16009CD3K2/8GX(XMP)	8GB (2x 4GB)	DS	-	-	9-9-9-27	1.65	•	•
KINGSTON	KHX1600C9D3B1/4G(XMP)	4GB	SS	-	-	9-9-9-27	1.65	•	•
KINGSTON	KHX1600C9D3K3/12GX(XMP)	12GB (3x 4GB)	DS	-	-	9	1.65	•	•
KINGSTON	KHX1600C9D3K3/6GX(XMP)	6GB (3x 2GB)	DS	-	-	9	1.65	•	•
KINGSTON	KHX1600C9D3K3/6GX(XMP)	6GB (3x 2GB)	DS	-	-	9	1.65	•	•
KINGSTON	KHX1600C9D3K4/16GX(XMP)	16GB (4x 4GB)	DS	-	-	9-9-9-24	1.65	•	•
KINGSTON	KHX1600C9D3K6/24GX(XMP)	24GB (6x 4GB)	DS	-	-	9	1.65	•	•
KINGSTON	KHX1600C9D3L2/8GX(XMP)	8GB (2x 4GB)	DS	-	-	9-9-9-24	1.35	•	•
KINGSTON	KHX1600C9D3P1K2/8G	8GB (2x 4GB)	DS	-	-	9	1.5	•	•
KINGSTON	KHX16C10B1K2/16X(XMP)	16GB (2x 8GB)	DS	-	-	-	1.5	•	•
KINGSTON	KHX16C9K2/16	16GB (2x 8GB)	DS	-	-	1333-9- 9-9-24	1.5	•	•
KINGSTON	KHX16C9P1K2/16	16GB (2x 8GB)	DS	-	-	-	1.5	•	•
KINGSTON	KVR16N11/4	4GB	DS	KINGSTON	D2568JPUCCPGBU	11-11- 11-28-1	-	•	•
KINGSTON	KVR16N11/4	4G	DS	Hynix	H5TQ2G83CFRFBPC	-	1.5	•	•
Micron	MT16JTF1G64AZ-1G6E1	8GB	DS	Micron	D9QBJ	-	-	•	•
Micron	MT8JTF51264AZ-1G6E1	4GB	SS	Micron	D9QBJ	-	-	•	•
Micron	MT8KTF25664AZ-1G6M1	2GB	SS	MICRON	D9PFJ	-	-	•	•

(continued on the next page)

## DDR3 1600 MHz capability

Vendors	Part No.	Size	SS/ DS	Chip Brand	Chip NO.	Timing	Voltage	DIMM socket support (Optional)	
								2	4
Patriot	PV316G160C9K(XMP)	16GB (2x 4GB )	SS	-	-	1600-9-9- 9-24	1.5	•	•
Patriot	PV316G160C9K(XMP)	16GB (2x 8GB)	SS	-	-	1600-9-9- 9-24	1.5	•	•
SanMax	SMD-4G28N1P-16KM	4GB	SS	ELPIDA	J4208BBBG-GN-F	1600	-	•	•
SanMax	SMD-4G68HP-16KZ	4GB	DS	Hynix	H5TQ2G83BFRPBC	-	1.5	•	•
SanMax	SMD-4G68NG-16KK	4GB	DS	ELPIDA	J2108BDBG-GN-F	-	-	•	•
SanMax	SMD-8G28NP-16KM	8GB	DS	ELPIDA	J4208BBBG-GN-F	1600	-	•	•
Silicon Power	SP002GBLTU160V02(XMP)	2GB	SS	S-POWER	20YT5NG	9-11- 11-28	1.5	•	•
Silicon Power	SP004GBLTU160V02(XMP)	4GB	DS	S-POWER	20YT5NG	9-9-9-24	1.5	•	•
Silicon Power	SP004GXYU160NSA(XMP)	4GB	SS	-	-	1600-9-9- 9-27	-	•	•
Silicon Power	SP008GXYU160NSA(XMP)	8GB	DS	-	-	1600-9-9- 9-27	-	•	•
Team	TED34GM1600C11BK	4GB	DS	Hynix	H5TC2G83EFR	11-11- 11-28	1.5	•	•
Team	TED38GM1600C11BK	8GB	DS	Hynix	H5TQ4G83AFR	11-11- 11-28	1.5	•	•
Team	TLD34G1600HC9BK(XMP)	8GB (2x 4GB )	DS	-	-	9-9-9-24	1.5	•	•
Team	TLD38G1600HC9BK(XMP)	16GB (2x 8GB)	DS	-	-	9-9-9-24	1.5	•	•
Team	TXD34096M1600HC9- D(XMP)	4GB	DS	Hynix	H5TC2G83BFRH9A	9-9-9-24	1.5	•	•
Transcend	TS1GLK64V6H(620945)	8GB	DS	SAMSUNG	K4B4G0846B	-	-	•	•
Transcend	TS1GLK64W6H	8GB	DS	SAMSUNG	K4B4G0846B	11-11-11- 28-1	-	•	•
Transcend	TS512MLK64W6H	4GB	SS	SAMSUNG	K4B4G0846B	11-11-11- 28-2	-	•	•
UMAX	84E44G93UM-16BPSYW	4GB	SS	UMAX	U2S96D30TP-16	1600-11- 11-11-28	-	•	•
UMAX	84E48G93UM-16BPSYW	8GB	DS	UMAX	U2S96D30TP-16	1600-11- 11-11-28	-	•	•

## DDR3 1333 MHz capability

Vendors	Part No.	Size	SS/ DS	Chip Brand	Chip NO.	Timing	Voltage	DIMM socket support (Optional)	
								2	4
AMD	AE32G1339U1-U	2GB	SS	AMD	23EY4587MB3H	-	1.5	•	•
AMD	AE34G1339U2-U	4GB	DS	AMD	23EY4587MB3H	-	1.5	•	•
Apacer	78.B1GDE.9L10C	4GB	DS	Apacer	AM5D5908CEHSBG	9	-	•	•
Asint	SLA302G08-EDJ1C	2GB	SS	ASint	302G08-DJ1C	-	-	•	•
Asint	SLA304G08-EDJ1B	4GB	SS	Asint	304G08-DJ1B	9-10-10-26	-	•	•
Asint	SLB304G08-EDJ1B	8GB	DS	Asint	304G08-DJ1B	9-9-9-24	-	•	•
BUFFALO	D3U1333-1G	1GB	SS	Elpida	J1108BFBG-DJ-F	-	-	•	•
BUFFALO	D3U1333-2G	2GB	DS	Elpida	J1108BFBG-DJ-F	-	-	•	•
BUFFALO	D3U1333-4G	4GB	DS	NANYA	NT5CB256M8BN-CG	-	-	•	•
CORSAIR	CMV8GX3M1A1333C9	8GB	DS	-	-	9-9-9-24	-	•	•
CORSAIR	CMV8GX3M2A1333C9	8GB (2x 4GB)	DS	-	N/A	9-9-9-24	-	•	•
CORSAIR	CMX4GX3M1A1333C9 (Ver2.12)	4GB (1x 4GB)	DS	-	-	9-9-9-24	1.5	•	
CORSAIR	CMX4GX3M1A1333C9 (Ver5.11)	4GB (1x 4GB)	DS	-	-	9-9-9-24	1.5	•	
CORSAIR	CMX8GX3M1A1333C9 (Ver2.2)	8GB	DS	-	-	9-9-9-24	1.5	•	
CORSAIR	CMX8GX3M2A1333C9(XMP)	8GB (2x 4GB)	DS	-	-	9-9-9-24	1.5	•	•
G.SKILL	F3-10666CL9D-8GBXL	8GB (2x 4GB)	DS	-	-	9-9-9-24	1.5	•	•
GEIL	GG34GB1333C9DC	4GB (2x 2GB)	DS	GEIL	GL1L128M88BA15B	9-9-9-24	1.3	•	•
GEIL	GVP34GB1333C9DC	4GB (2x 2GB)	DS	-	-	9-9-9-24	1.5	•	•
GEIL	GVP38GB1333C9DC	8GB (2x 4GB)	DS	-	-	9-9-9-24	1.5	•	•
INNOVODISK	M3UN-2GHJBC09	2GB	SS	Hynix	H5TQ2G83CFRH9C	9-9-9-24	-	•	•
INNOVODISK	M3UN-4GHJAC09	4GB	DS	Hynix	H5TQ2G83CFRH9C	9-9-9-24	-	•	•
KINGMAX	FLFE85F-C8KL9	2GB	SS	KINGMAX	KFC8FNLBF-GXX-12A	-	-	•	•
KINGMAX	FLFE85F-C8KL9	2GB	SS	KINGMAX	KFC8FNLXF-DXX-15A	-	-	•	•
KINGMAX	FLFF65F-C8KL9	4GB	DS	KINGMAX	KFC8FNLXF-DXX-15A	-	-	•	•
KINGSTON	KVR1333D3E9S/4G	4GB	DS	Elpida	J2108ECSE-DJ-F	9	1.5	•	•
KINGSTON	KVR1333D3N9H/4G	4GB	DS	ELPIDA	J2108BDBG-GN-F	-	1.5	•	•
KINGSTON	KVR13N9S8H/4	4GB	SS	ELPIDA	J4208BBBG-GN-F	-	1.5	•	•

(continued on the next page)

## DDR3 1333 MHz capability

Vendors	Part No.	Size	SS/ DS	Chip Brand	Chip NO.	Timing	Voltage	DIMM socket support (Optional)	
								2	4
Mach Xtreme	MXD3U133316GQ	16GB (4x 4GB)	DS	-	-	-	-	•	•
Mach Xtreme	MXD3V13332GS	2GB	SS	Mach Xtreme	C2S46D30-D313	-	-	•	•
MICRON	MT8JTF25664AZ-1G4M1	2GB	SS	MICRON	D9PFJ	-	-	•	•
Patriot	PSD32G13332	2GB	DS	Patriot	PM128M8D3BU-15	9	-	•	•
RiDATA	C304627CB1AG22Fe	2GB	DS	RiDATA	C304627CB1AG22Fe	9	-	•	•
RiDATA	E304459CB1AG32Cf	4GB	DS	RiDATA	E304459CB1AG32Cf	9	-	•	•
Silicon Power	SP001GBLTU133S02	1GB	SS	S-POWER	10YT3E5	9	-	•	•
Silicon Power	SP002GBLTU133V02	2GB	SS	S-POWER	20YT3NG	9-9-9-24	-	•	•
Silicon Power	SP004GBLTU133V02	4GB	DS	S-POWER	20YT3NG	9-9-9-24	-	•	•
UMAX	84E44G93UM-13BPSYW	4GB	SS	UMAX	U2S96D30TP-13	1333-9-9-9-24	-	•	•
UMAX	84E48G93UM-13BPSYW	8GB	DS	UMAX	U2S96D30TP-13	1333-9-9-9-24	-	•	•



Side(s): SS - Single-sided DS - Double-sided DIMM support:

- (1) Supports one (1) module inserted into any slot as Single-channel memory configuration. We suggest that you install the module into A1 slot.
- (2) Supports two (2) modules inserted into either the beige slots or the brown slots as one pair of Dual-channel memory configuration. We suggest that you install the modules into slots A1 and B1 for better compatibility.
- (4) Supports four (4) modules inserted into both the beige and brown slots as two pairs of Dual-channel memory configuration.



- ASUS exclusively provides hyper DIMM support function.
- Hyper DIMM support is subject to the physical characteristics of individual CPUs. Load the X.M.P. settings in the BIOS for the hyper DIMM support.
- Visit the ASUS website for the latest QVL.

## 1.2.5 Expansion slots



Unplug the power cord before adding or removing expansion cards. Failure to do so may cause you physical injury and damage motherboard components.

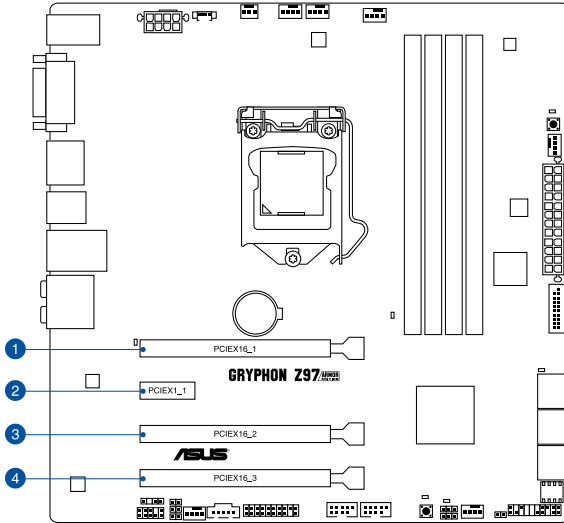

Slot No.	Slot Description
1	PCIe 3.0/2.0 x16_1 slot
2	PCIe 2.0 x1_1 slot
3	PCIe 3.0/2.0 x16_2 slot
4	PCIe 2.0 x16_3 slot



- We recommend that you provide sufficient power when running CrossFireX™ or SLI™ mode.
- Connect a chassis fan to the motherboard connector labeled CHA\_FAN1-4 when using multiple graphics cards for better thermal environment.

## IRQ assignments for this motherboard

	A	B	C	D	E	F	G	H
PCIe x16_1	shared	-	-	-	-	-	-	-
PCIe x16_2	-	shared	-	-	-	-	-	-
PCIe x16_3	shared	-	-	-	-	-	-	-
PCIe x1_1	-	-	-	shared	-	-	-	-
SMBus Controller	-	-	shared	-	-	-	-	-
SATA #0	-	-	-	shared	-	-	-	-
SATA #1	-	-	-	shared	-	-	-	-
GbE Controller	-	-	-	-	shared	-	-	-
EHCI #0	-	-	-	-	-	-	-	shared
EHCI #1	shared	-	-	-	-	-	-	-
XHCI Controller	-	-	-	-	-	shared	-	-
High Definition Audio	-	-	-	-	-	-	shared	-



## 1.2.6 Onboard buttons

Onboard buttons allow you to fine-tune performance when working on a bare or open-case system. This is ideal for overclockers and gamers who continually change settings to enhance system performance.

### 1. MemOK! button

Installing DIMMs that are not compatible with the motherboard may cause system boot failure, and the DRAM\_LED near the MemOK! switch lights continuously. Press and hold the MemOK! button until the DRAM\_LED starts blinking to begin automatic memory compatibility tuning for successful boot.

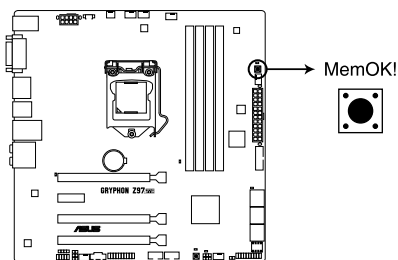

**GRYPHON Z97 ARMOR EDITION MemOK! button**



- Refer to section **Onboard LEDs** for the exact location of the DRAM\_LED.
- The DRAM\_LED also lights up when the DIMM is not properly installed. Turn off the system and reinstall the DIMM before using the MemOK! function.
- The MemOK! button does not function under Windows® OS environment.
- During the tuning process, the system loads and tests failsafe memory settings. It takes about 30 seconds for the system to test one set of failsafe settings. If the test fails, the system reboots and test the next set of failsafe settings. The blinking speed of the DRAM\_LED increases, indicating different test processes.
- Due to memory tuning requirement, the system automatically reboots when each timing set is tested. If the installed DIMMs still fail to boot after the whole tuning process, the DRAM\_LED lights continuously. Replace the DIMMs with ones recommended in the Memory QVL (Qualified Vendors Lists) in this user manual or on the ASUS website at [www.asus.com](http://www.asus.com).
- If you turn off the computer and replace DIMMs during the tuning process, the system continues memory tuning after turning on the computer. To stop memory tuning, turn off the computer and unplug the power cord for about 5–10 seconds.
- If your system fails to boot up due to BIOS overclocking, press the MemOK! button to boot and load the BIOS default settings. A message will appear during POST reminding you that the BIOS has been restored to its default settings.
- We recommend that you download and update to the latest BIOS version from the ASUS website at [www.asus.com](http://www.asus.com) after using the MemOK! function.

## 2. BIOS Flashback button (BIOS\_FLBK)

Press this button to enable the BIOS Flashback feature.

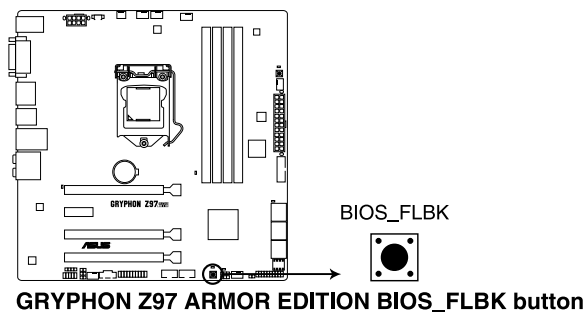

## 1.2.7 Jumpers

### 1. Clear RTC RAM (3-pin CLRRTC)

This jumper allows you to clear the Real Time Clock (RTC) RAM in CMOS. You can clear the CMOS memory of date, time, and system setup parameters by erasing the CMOS RTC RAM data. The onboard button cell battery powers the RAM data in CMOS, which include system setup information such as system passwords.

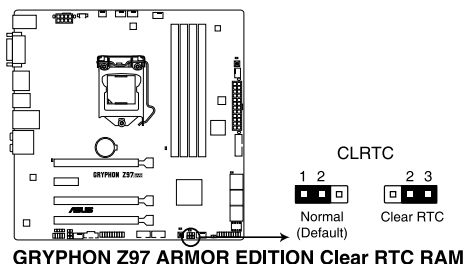

To erase the RTC RAM:

1. Turn OFF the computer and unplug the power cord.
2. Move the jumper cap from pins 1-2 (default) to pins 2-3. Keep the cap on pins 2-3 for about 5-10 seconds, then move the cap back to pins 1-2.
3. Plug the power cord and turn ON the computer.
4. Hold down the <Delete> key during the boot process and enter BIOS setup to re-enter data.



Except when clearing the RTC RAM, never remove the cap on CLRRTC jumper default position. Removing the cap will cause system boot failure!



- If the steps above do not help, remove the onboard battery and move the jumper again to clear the CMOS RTC RAM data. After the CMOS clearance, reinstall the battery.
- You do not need to clear the RTC when the system hangs due to overclocking. For system failure due to overclocking, use the C.P.R. (CPU Parameter Recall) feature. Shut down and reboot the system so the BIOS can automatically reset parameter settings to default values.
- Due to the chipset behavior, AC power off is required to enable C.P.R. function. You must turn off and on the power supply or unplug and plug the power cord before rebooting the system.

**2. CPU Over Voltage jumper (3-pin CPU\_OV)**

The CPU Over Voltage jumper allows you to set a higher CPU voltage for a flexible overclocking system, depending on the type of the installed CPU. To gain more CPU voltage setting, insert the jumper to pins 2-3. To go back to its default CPU voltage setting, insert the jumper to pins 1-2.

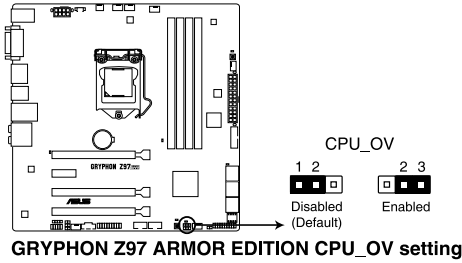

## 1.2.8 Onboard LEDs

### 1. POST State LEDs

The POST State LEDs provide the status of these key components during POST (Power-On-Self Test): CPU, memory modules, VGA card, and hard disk drives. If an error is found, the critical component's LED stays lit up until the problem is solved.

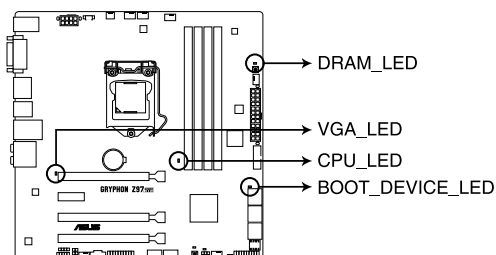

**GRYPHON Z97 ARMOR EDITION CPU/ DRAM/  
BOOT\_DEVICE/ VGA LED**

### 2. USB BIOS Flashback LED (FLBK\_LED)

This LED flashes when you press the BIOS Flashback button for BIOS update.

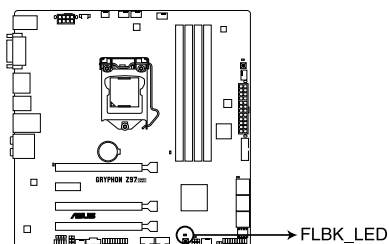

**GRYPHON Z97 ARMOR EDITION FLBK\_LED**



For more information on how to update the BIOS, refer to **Chapter 2** of this user guide.

## 1.2.9 Internal connectors

### 1. Intel® Z97 Serial ATA 6.0 Gb/s connectors (7-pin SATA6G\_1-6 [brown])

These connectors connect to Serial ATA 6.0 Gb/s hard disk drives via Serial ATA 6.0 Gb/s signal cables.

If you installed Serial ATA hard disk drives, you can create a RAID 0, 1, 5, and 10 configuration with the Intel® Rapid Storage Technology through the onboard Intel® Z97 chipset.

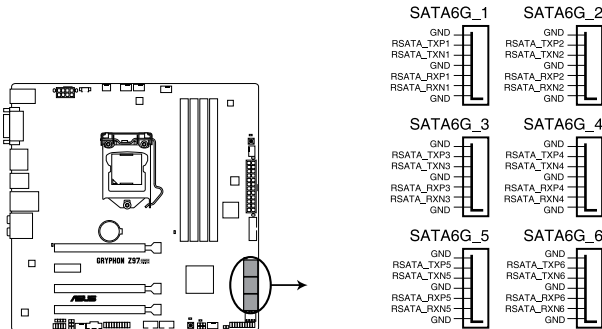

**GRYPHON Z97 ARMOR EDITION Intel® SATA 6 Gb/s connectors**

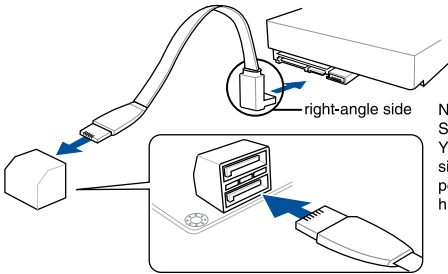

**NOTE:** Connect the right-angle side of SATA signal cable to SATA device. You may also connect the right-angle side of SATA cable to the onboard SATA port to avoid mechanical conflict with huge graphics cards.



- These connectors are set to **[AHCI Mode]** by default. If you intend to create a Serial ATA RAID set using these connectors, set the SATA Mode item in the BIOS to **[RAID Mode]**. Refer to section **3.6.3 SATA Configuration** for details.
- Before creating a RAID set, refer to section **5.1 RAID configurations** or the manual bundled in the motherboard support DVD.

## 2. USB 3.0 connector (20-pin USB3\_12)

This connector allows you to connect a USB 3.0 module for additional USB 3.0 front or rear panel ports. With an installed USB 3.0 module, you can enjoy all the benefits of USB 3.0 including faster data transfer speeds of up to 5Gbps, faster charging time for USB-chargeable devices, optimized power efficiency, and backward compatibility with USB 2.0.

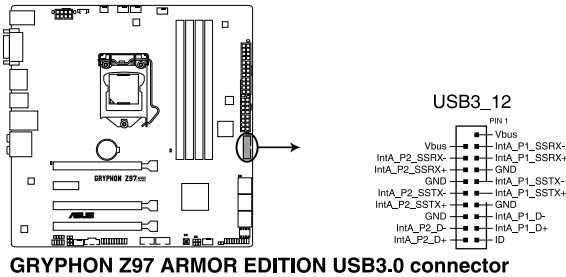

**GRYPHON Z97 ARMOR EDITION USB3.0 connector**



These connectors are based on xHCI specification. We recommend you to install the related driver to fully use the USB 3.0 ports under Windows® 7 or later Windows® OS.

**3. Digital audio connector (4-1 pin SPDIF\_OUT)**

This connector is for an additional Sony/Philips Digital Interface (S/PDIF) port. Connect the S/PDIF Out module cable to this connector, then install the module to a slot opening at the back of the system chassis.

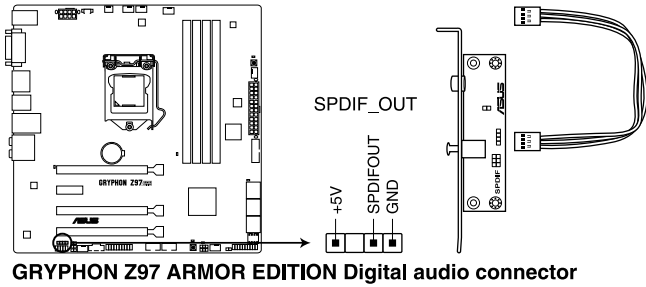

---

The S/PDIF module is purchased separately.

---



#### 4. USB 2.0 connectors (10-1 pin USB1112; USB1314)

These connectors are for USB 2.0 ports. Connect the USB module cable to any of these connectors, then install the module to a slot opening at the back of the system chassis. These USB connectors comply with USB 2.0 specification that supports up to 48 MBps connection speed.

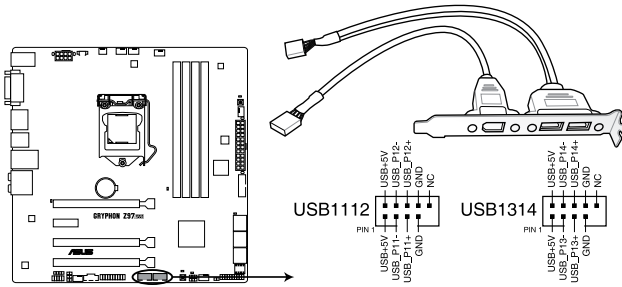

**GRYPHON Z97 ARMOR EDITION USB2.0 connectors**



DO NOT connect a 1394 cable to the USB connectors. Doing so will damage the motherboard!



You can connect the front panel USB cable to the ASUS Q-Connector (USB, dark brown) first, and then install the Q-Connector (USB) to the USB connector onboard if your chassis supports front panel USB ports.



The USB 2.0 module is purchased separately.

5. CPU, optional, chassis, and assistant fan connectors (4-pin CPU\_FAN; 4-pin CPU\_OPT; 4-pin CHA\_FAN1-4; 3-pin ASST\_FAN1, 4-pin ASST\_FAN2)

Connect the fan cables to the fan connectors on the motherboard.

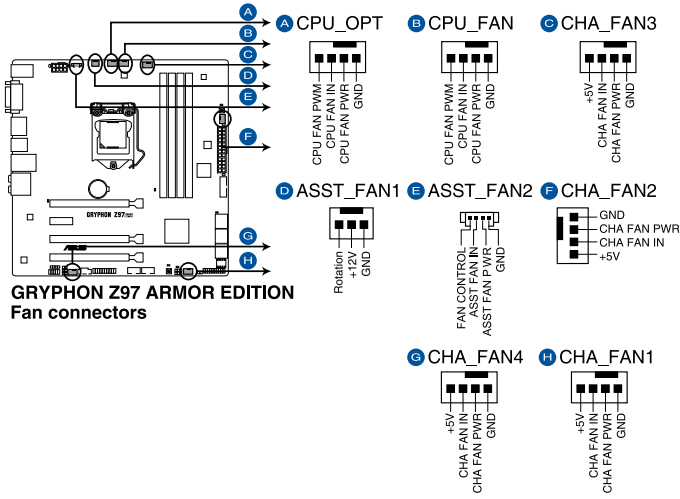

- DO NOT forget to connect the fan cables to the fan connectors. Insufficient air flow inside the system may damage the motherboard components. These are not jumpers! Do not place jumper caps on the fan connectors!
- Ensure that the CPU FAN cable is securely installed to the CPU fan connector.



- The CPU\_FAN connector supports the CPU fan of maximum 1A (12 W) fan power.
- The CPU\_FAN, CHA\_FAN, and ASST\_FAN connectors support the TUF Thermal Radar 2 feature.

## 6. Front panel audio connector (10-1 pin AAFP)

This connector is for a chassis-mounted front panel audio I/O module that supports either HD Audio or legacy AC'97 audio standard. Connect one end of the front panel audio I/O module cable to this connector.

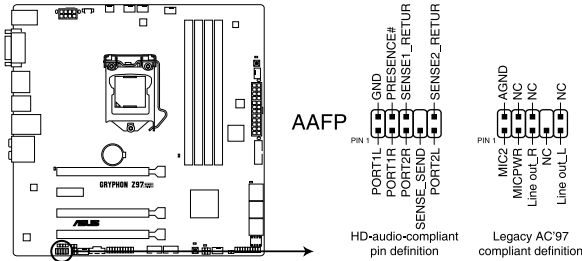

**GRYPHON Z97 ARMOR EDITION Analog front panel connector**



- We recommend that you connect a high-definition front panel audio module to this connector to avail of the motherboard's high-definition audio capability.
- If you want to connect a high-definition or an AC'97 front panel audio module to this connector, set the Front Panel Type item in the BIOS setup to **[HD]** or **[AC97]**.

## 7. Thermal Sensor connectors (2-pin T\_SENSOR1; T\_SENSOR2;T\_SENSOR3)

These connectors are for the thermistor cables that monitor the temperature of the devices and the critical components inside the motherboard. Connect the thermistor cable and place the sensor on the device or the motherboard's component to detect its temperature.

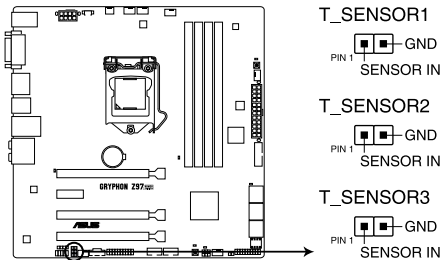

**GRYPHON Z97 ARMOR EDITION T\_SENSOR connectors**

### 8. ATX power connectors (24-pin EATXPWR; 8-pin EATX12V)

These connectors are for ATX power supply plugs. The power supply plugs are designed to fit these connectors in only one orientation. Find the proper orientation and push down firmly until the connectors completely fit.

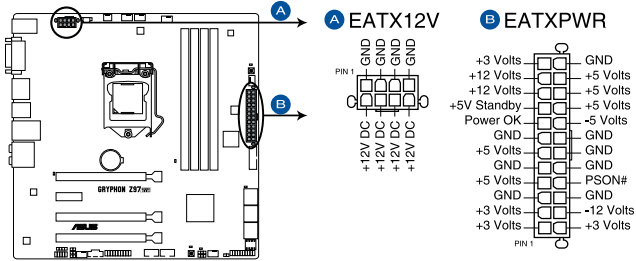

**GRYPHON Z97 ARMOR EDITION ATX power connectors**



- For a fully configured system, we recommend that you use a power supply unit (PSU) that complies with ATX 12 V Specification 2.0 (or later version) and provides a minimum power of 350 W.
- DO NOT forget to connect the 4-pin/8-pin EATX12 V power plug. Otherwise, the system will not boot.
- We recommend that you use a PSU with a higher power output when configuring a system with more power-consuming devices. The system may become unstable or may not boot up if the power is inadequate.
- If you want to use two or more high-end PCI Express x16 cards, use a PSU with 1000W power or above to ensure the system stability.

## 9. System panel connector (20-8 pin PANEL)

This connector supports several chassis-mounted functions.

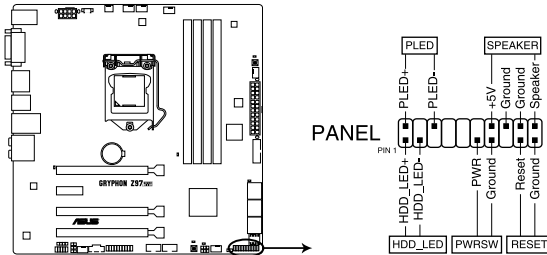

**GRYPHON Z97 ARMOR EDITION System panel connector**

- **System power LED (2-pin PLED)**

This 2-pin connector is for the system power LED. Connect the chassis power LED cable to this connector. The system power LED lights up when you turn on the system power, and blinks when the system is in sleep mode.

- **Hard disk drive activity LED (2-pin IDE\_LED)**

This 2-pin connector is for the HDD Activity LED. Connect the HDD Activity LED cable to this connector. The IDE LED lights up or flashes when data is read from or written to the HDD.

- **System warning speaker (4-pin SPEAKER)**

This 4-pin connector is for the chassis-mounted system warning speaker. The speaker allows you to hear system beeps and warnings.

- **ATX power button/soft-off button (2-pin PWRSW)**

This connector is for the system power button. Pressing the power button turns the system on or puts the system in sleep or soft-off mode depending on the operating system settings. Pressing the power switch for more than four seconds while the system is ON turns the system OFF.

- **Reset button (2-pin RESET)**

This 2-pin connector is for the chassis-mounted reset button for system reboot without turning off the system power.

## 10. TPM connector (20-1 pin TPM)

This connector supports a Trusted Platform Module (TPM) system, which securely store keys, digital certificates, passwords and data. A TPM system also helps enhance the network security, protects digital identities, and ensures platform integrity.

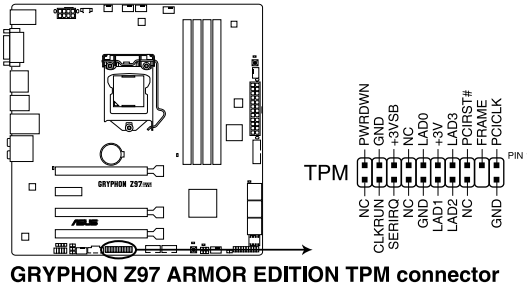

## 11. DirectKey connector (2-pin DRCT)

This connector is for the chassis-mounted button that supports the DirectKey function. Connect the button cable that supports DirectKey, from the chassis to this connector on the motherboard.

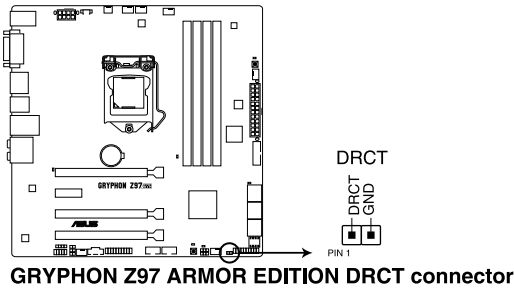

Ensure that your chassis comes with the extra button cable that supports the DirectKey feature. Refer to the technical documentation that came with the chassis for details.

## 12. Thunderbolt header (5-pin TB\_HEADER)

This connector is for the add-on Thunderbolt I/O card that supports Intel's Thunderbolt Technology, allowing you to connect up to six Thunderbolt-enabled devices and a DisplayPort-enabled display in a daisy-chain configuration.

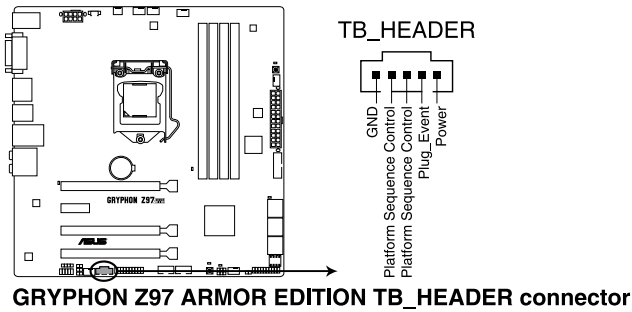

The add-on Thunderbolt I/O card and Thunderbolt cables are purchased separately.





# Basic installation

# 2

## 2.1 Building your PC system

### 2.1.1 Motherboard installation



The diagrams in this section are for reference only. The motherboard layout may vary with models, but the installation steps are the same for all models.

1. Install the ASUS Q-Shield to the chassis rear I/O panel.

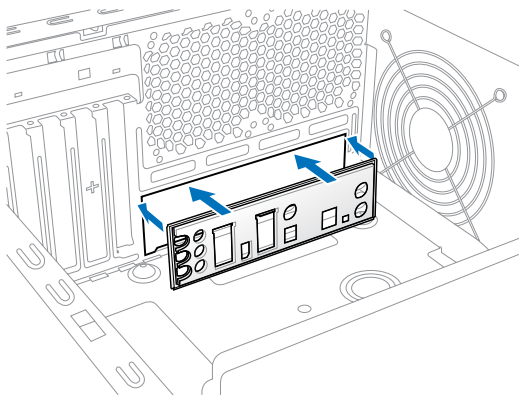

2. Place the motherboard into the chassis, ensuring that its rear I/O ports are aligned to the chassis' rear I/O panel.

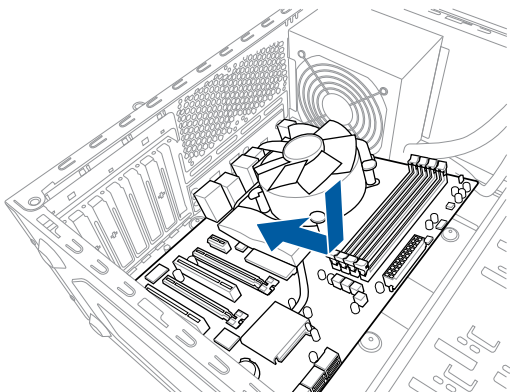

- Place nine screws into the holes indicated by circles to secure the motherboard to the chassis.

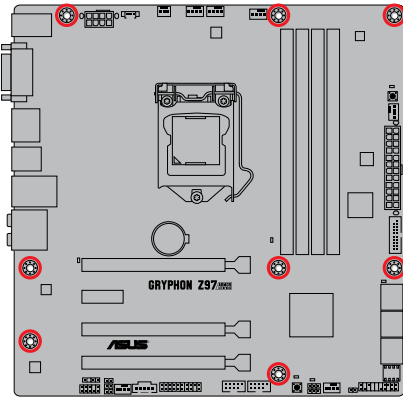
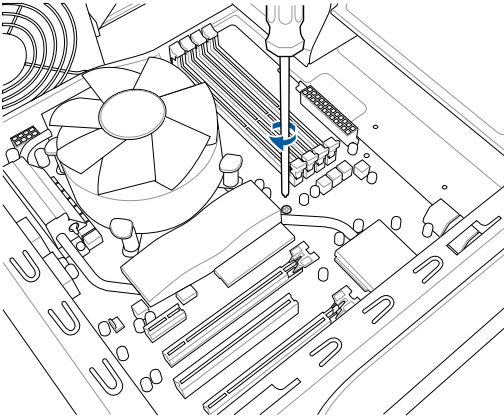

**DO NOT** over tighten the screws! Doing so can damage the motherboard.

## 2.1.2 CPU installation



Ensure that you install the correct CPU designed for LGA1150 socket only. DO NOT install a CPU designed for LGA1155 and LGA1156 sockets on the LGA1150 socket.

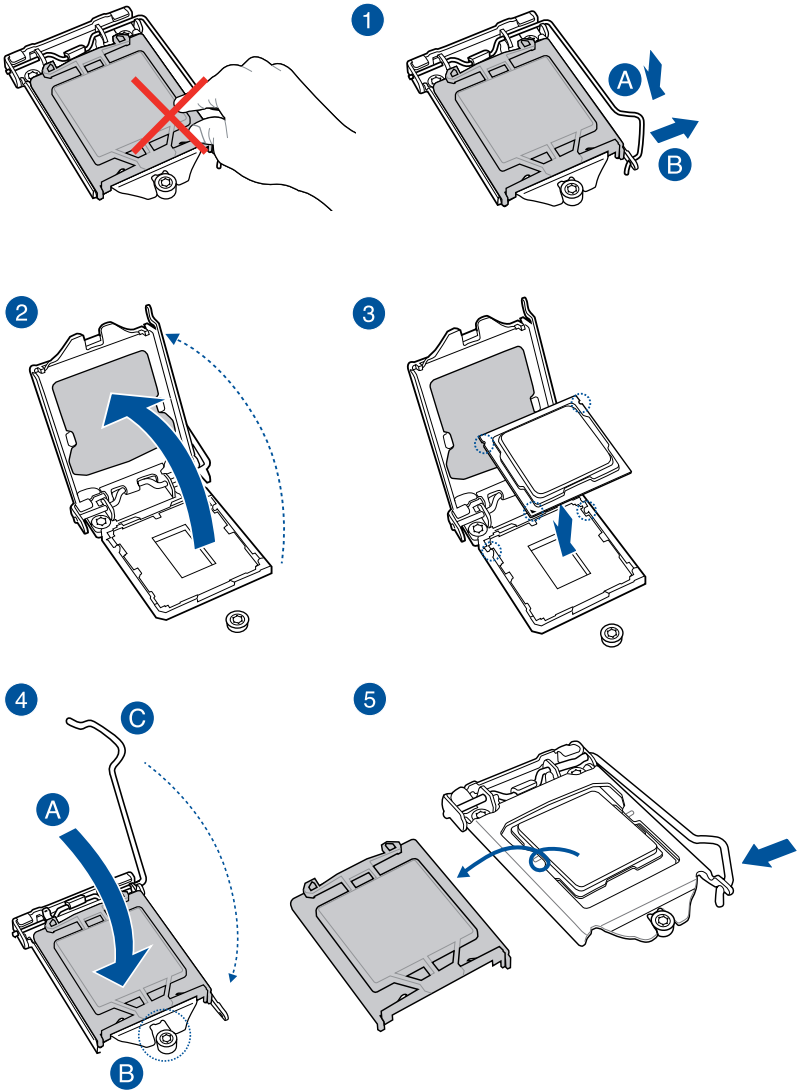

### 2.1.3 CPU heatsink and fan assembly installation

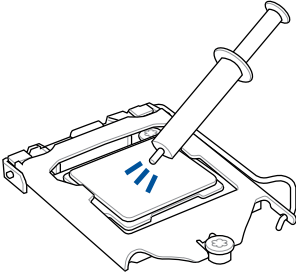

Apply the Thermal Interface Material to the CPU heatsink and CPU before you install the heatsink and fan, if necessary.

To install the CPU heatsink and fan assembly

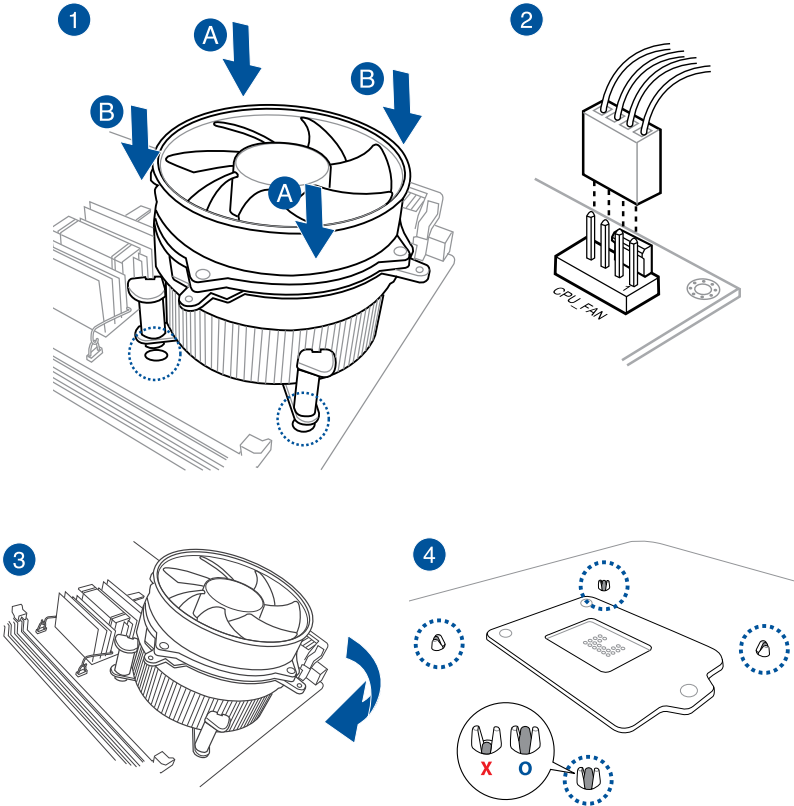

To uninstall the CPU heatsink and fan assembly

1

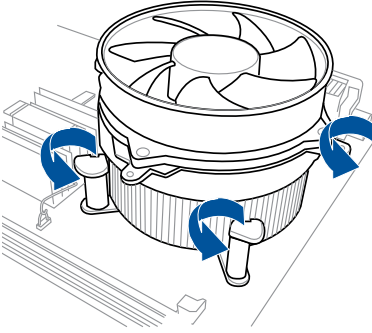

2

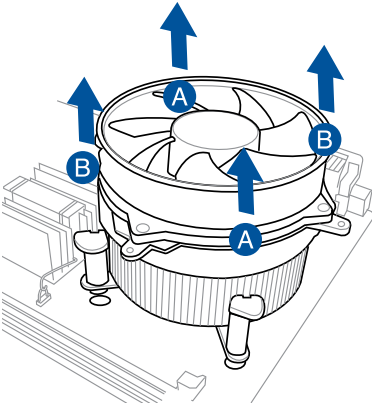

### 2.1.4 DIMM installation

1

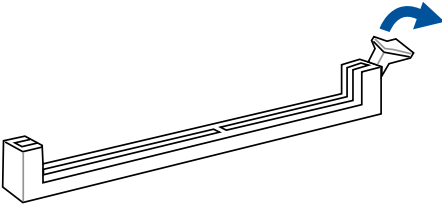

2

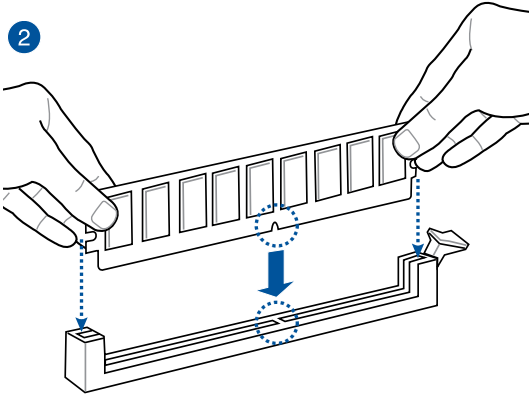

3

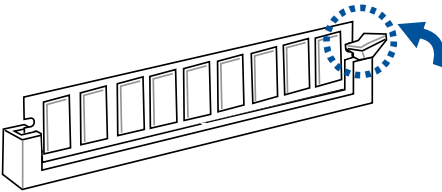

#### To remove a DIMM

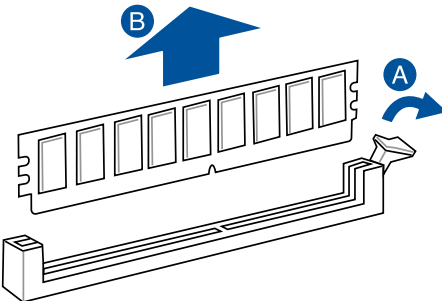

## 2.1.5 ATX Power connection

1

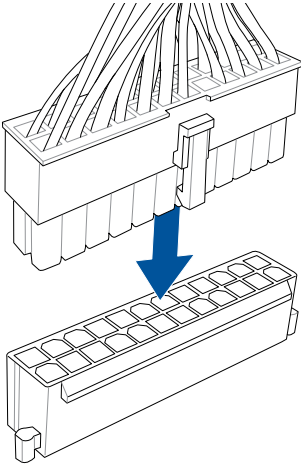

2

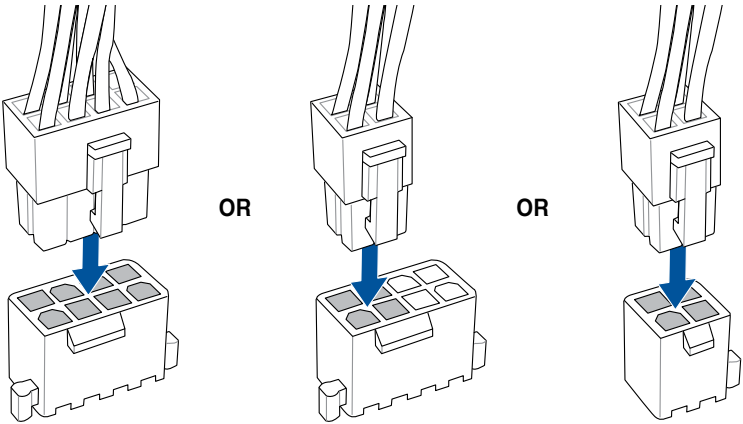

## 2.1.6 SATA device connection

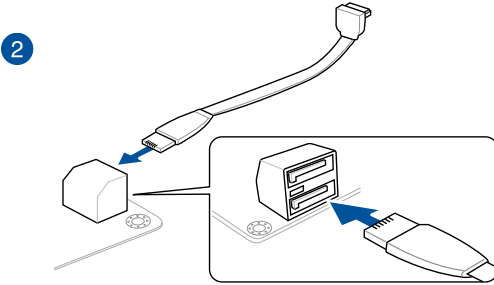
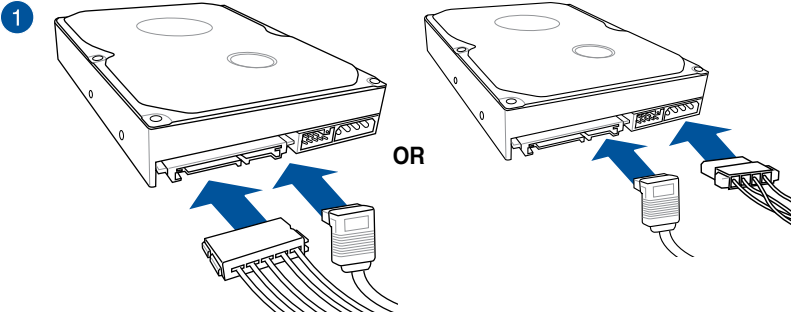

OR

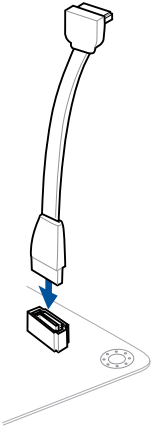



## 2.1.7 Front I/O Connector

### To install ASUS Q-Connector

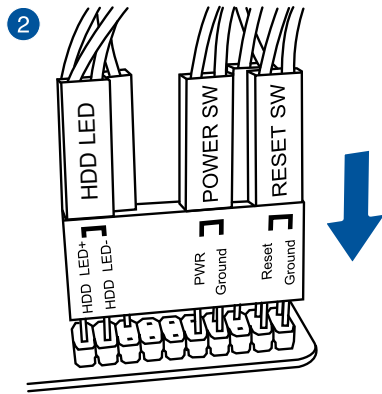
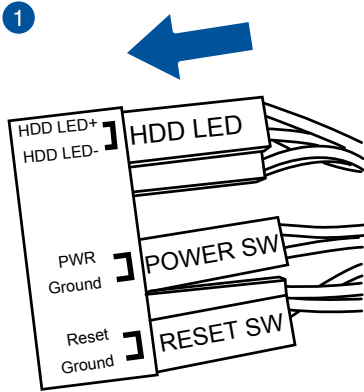

### To install USB 2.0 connector

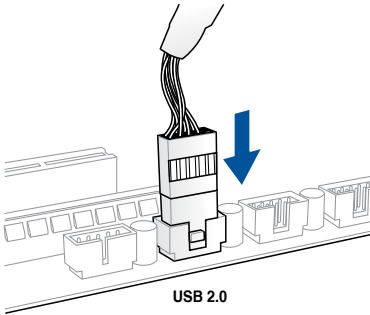

### To install front panel audio connector

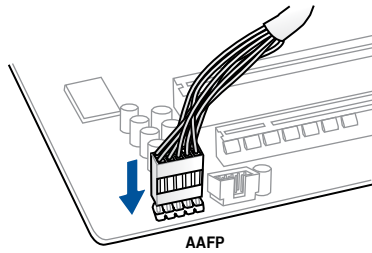

### To install USB 3.0 connector

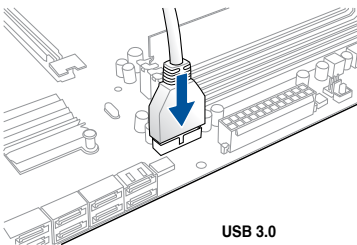

## 2.1.8 Expansion Card installation

To install PCIe x16 cards

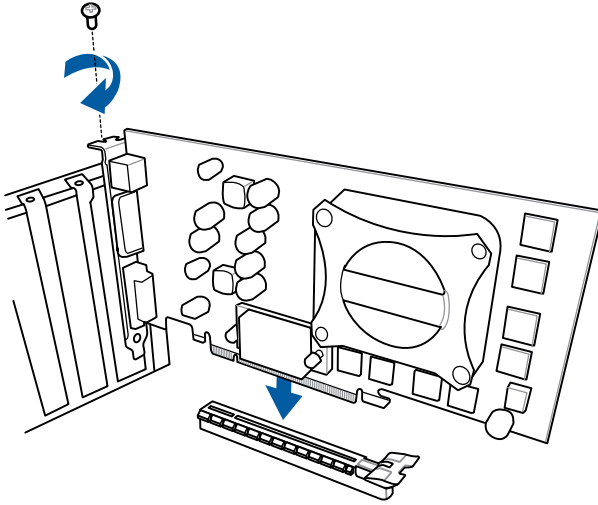

To install PCIe x1 cards

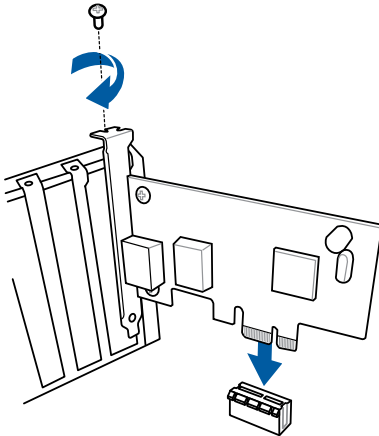

## 2.2 BIOS update utility

### USB BIOS Flashback

USB BIOS Flashback allows you to easily update the BIOS without entering the existing BIOS or operating system. Simply insert a USB storage device to the USB port, press the USB BIOS Flashback button for three seconds, and the BIOS is updated automatically.

#### To use USB BIOS Flashback:

1. Place the bundled support DVD to the optical drive and install the USB BIOS Flashback Wizard. Follow the onscreen instructions to complete the installation.
2. Insert the USB storage device to the USB Flashback port.



We recommend you to use a USB 2.0 storage device to save the latest BIOS version for better compatibility and stability.

3. Launch the USB BIOS Flashback Wizard to automatically download the latest BIOS version.
4. Press the BIOS Flashback button for three seconds until a flashing light appears, which indicates that the BIOS Flashback function is enabled.
5. Wait until the light goes out, indicating that the BIOS updating process is completed.

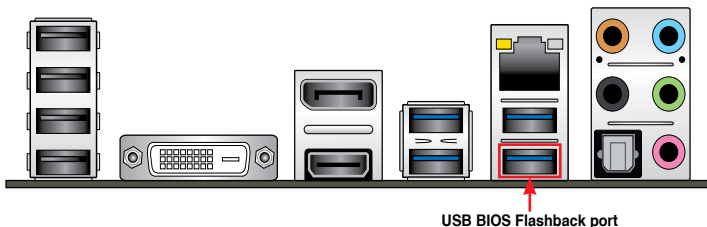

For more BIOS update utilities in BIOS setup, refer to the section **Updating BIOS** in Chapter 3.



- Do not unplug portable disk, power system, or use the CLR\_CMOS jumper while BIOS update is ongoing, otherwise update will be interrupted. In case of interruption, please follow the steps again.
- If the light flashes for five seconds and turns into a solid light, this means that the BIOS Flashback is not operating properly. This may be caused by improper installation of the USB storage device and filename/file format error. If this scenario happens, please restart the system to turn off the light.
- Updating BIOS may have risks. If the BIOS program is damaged during the process and results to the system's failure to boot up, please contact your local ASUS Service Center.

## 2.3 Motherboard rear and audio connections

### 2.3.1 Rear I/O connection

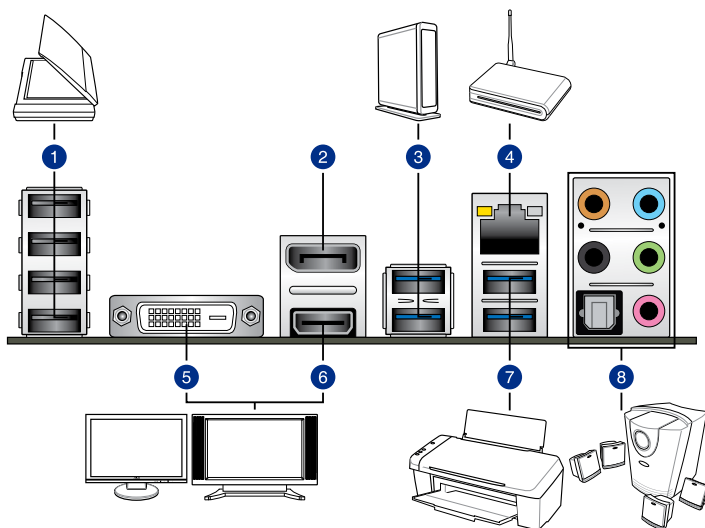

#### Rear panel connectors

1. USB 2.0 ports 7-10	5. DVI port
2. DisplayPort	6. HDMI port
3. USB 3.0 ports 5 and 6	7. USB 3.0 ports 3-4, support ASUS USB 3.0 Boost. Bottom port supports USB BIOS Flashback and USB Charger+.
4. LAN (RJ-45) port*	8. Audio I/O ports**

\* and \*\*: Refer to the tables on the next page for LAN port LEDs, and audio port definitions.



- USB 3.0 devices can only be used as data storage only.
- We strongly recommend that you connect USB 3.0 devices to USB 3.0 ports for faster and better performance for your USB 3.0 devices.
- Due to the design of the Intel® 9 series chipset, all USB devices connected to the USB 2.0 and USB 3.0 ports are controlled by the xHCI controller. Some legacy USB devices must update their firmware for better compatibility.
- Multi-VGA output supports up to three displays under Windows® OS environment, two displays under BIOS, and one display under DOS.

### \* LAN ports LED indications

Activity Link LED		Speed LED	
Status	Description	Status	Description
Off	No link	Off	10 Mbps connection
Orange	Linked	Orange	100 Mbps connection
Orange (Blinking)	Data activity	Green	1 Gbps connection
Orange (Blinking then steady)	Ready to wake up from S5 mode		

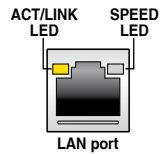

### \*\* Audio 2, 4, 6, or 8-channel configuration

Port	Headset 2-channel	4-channel	6-channel	8-channel
Light Blue	Line In	Line In	Line In	Line In
Lime	Line Out	Front Speaker Out	Front Speaker Out	Front Speaker Out
Pink	Mic In	Mic In	Mic In	Mic In
Orange	–	–	Center/Subwoofer	Center/Subwoofer
Black	–	Rear Speaker Out	Rear Speaker Out	Rear Speaker Out

## 2.3.2 Audio I/O connections

### Audio I/O ports

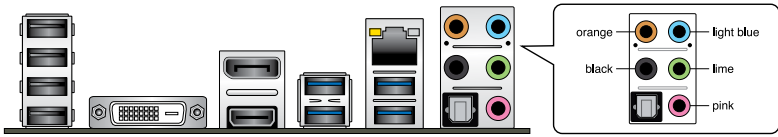

### Connect to Headphone and Mic



### Connect to Stereo Speakers

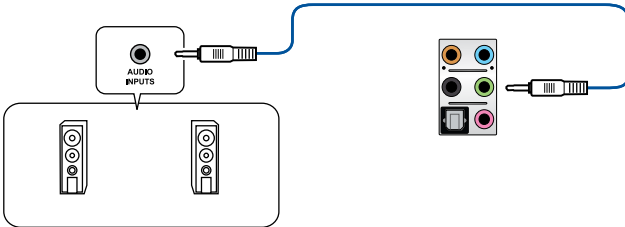

### Connect to 2.1 channel Speakers

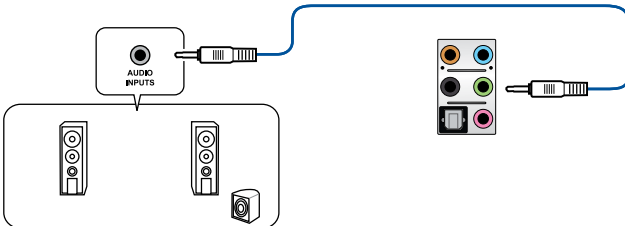

### Connect to 4.1 channel Speakers

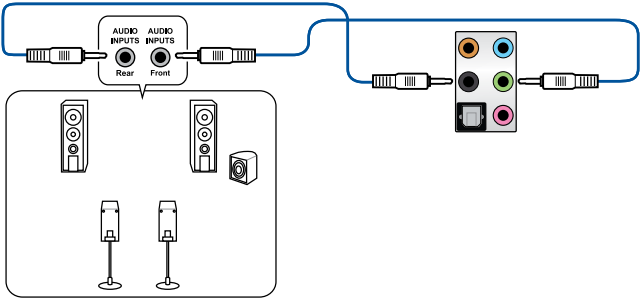

### Connect to 5.1 channel Speakers

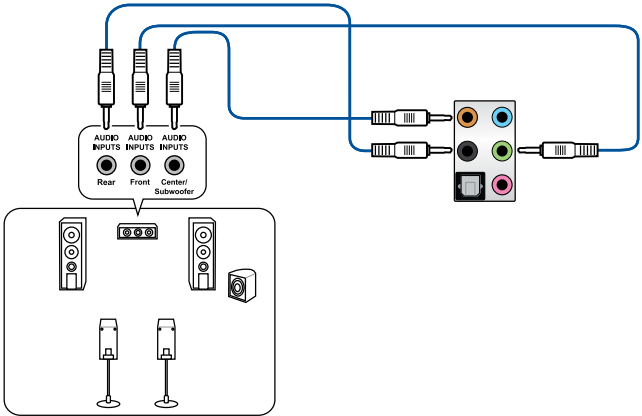

### Connect to 7.1 channel Speakers

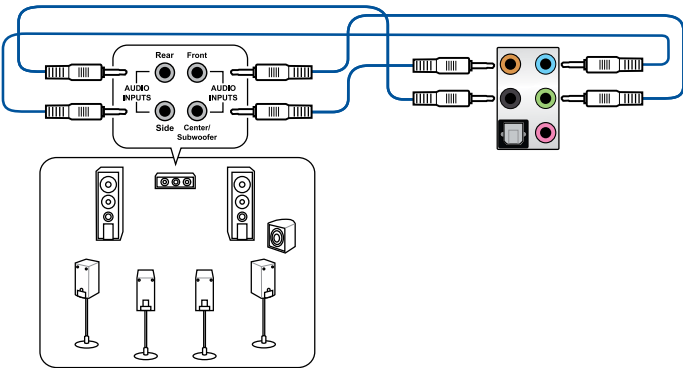

## 2.4 Starting up for the first time

1. After making all the connections, replace the system case cover.
2. Ensure that all switches are off.
3. Connect the power cord to the power connector at the back of the system chassis.
4. Connect the power cord to a power outlet that is equipped with a surge protector.
5. Turn on the devices in the following order:
  - a. Monitor
  - b. External SCSI devices (starting with the last device on the chain)
  - c. System power
6. After applying power, the system power LED on the system front panel case lights up. For systems with ATX power supplies, the system LED lights up when you press the ATX power button. If your monitor complies with the “green” standards or if it has a “power standby” feature, the monitor LED may light up or change from orange to green after the system LED turns on.

The system then runs the power-on self tests (POST). While the tests are running, the BIOS beeps (refer to the BIOS beep codes table) or additional messages appear on the screen. If you do not see anything within 30 seconds from the time you turned on the power, the system may have failed a power-on test. Check the jumper settings and connections or call your retailer for assistance.

BIOS Beep	Description
One short beep	VGA detected Quick boot set to disabled No keyboard detected
One continuous beep followed by two short beeps then a pause (repeated)	No memory detected
One continuous beep followed by three short beeps	No VGA detected
One continuous beep followed by four short beeps	Hardware component failure

7. At power on, hold down the <Delete> key to enter the BIOS Setup. Follow the instructions in Chapter 3.

## 2.5 Turning off the computer

While the system is ON, press the power button for less than four seconds to put the system on sleep mode or soft-off mode, depending on the BIOS setting. Press the power switch for more than four seconds to let the system enter the soft-off mode regardless of the BIOS setting.



# BIOS setup

# 3

## 3.1 Knowing BIOS



---

The new ASUS UEFI BIOS is a Unified Extensible Interface that complies with UEFI architecture, offering a user-friendly interface that goes beyond the traditional keyboard-only BIOS controls to enable a more flexible and convenient mouse input. You can easily navigate the new UEFI BIOS with the same smoothness as your operating system. The term "BIOS" in this user manual refers to "UEFI BIOS" unless otherwise specified.

---

BIOS (Basic Input and Output System) stores system hardware settings such as storage device configuration, overclocking settings, advanced power management, and boot device configuration that are needed for system startup in the motherboard CMOS. In normal circumstances, the default BIOS settings apply to most conditions to ensure optimal performance. **DO NOT change the default BIOS settings** except in the following circumstances:

- An error message appears on the screen during the system bootup and requests you to run the BIOS Setup.
- You have installed a new system component that requires further BIOS settings or update.



---

Inappropriate BIOS settings may result to instability or boot failure. **We strongly recommend that you change the BIOS settings only with the help of a trained service personnel.**

---



---

When downloading or updating the BIOS file, rename it as **Z97GP.CAP** for this motherboard.

---

## 3.2 BIOS setup program

Use the BIOS Setup to update the BIOS or configure its parameters. The BIOS screen include navigation keys and brief onscreen help to guide you in using the BIOS Setup program.

### Entering BIOS at startup

To enter BIOS Setup at startup, press <Delete> during the Power-On Self Test (POST). If you do not press <Delete>, POST continues with its routines.

### Entering BIOS Setup after POST

To enter BIOS Setup after POST:

- Press <Ctrl>+<Alt>+<Delete> simultaneously.
- Press the reset button on the system chassis.
- Press the power button to turn the system off then back on. Do this option only if you failed to enter BIOS Setup using the first two options.

After doing either of the three options, press <Delete> key to enter BIOS.



- 
- The BIOS setup screens shown in this section are for reference purposes only, and may not exactly match what you see on your screen.
  - Ensure that a USB mouse is connected to your motherboard if you want to use the mouse to control the BIOS setup program.
  - If the system becomes unstable after changing any BIOS setting, load the default settings to ensure system compatibility and stability. Select the **Load Optimized Defaults** item under the **Exit** menu or press hotkey <F5>. See section 3.10 **Exit Menu** for details.
  - If the system fails to boot after changing any BIOS setting, try to clear the CMOS and reset the motherboard to the default value. See section 1.2.6 **Onboard buttons and switches** for information on how to erase the RTC RAM via the Clear CMOS button.
  - The BIOS setup program does not support the Bluetooth devices.
- 

### BIOS menu screen

The BIOS Setup program can be used under two modes: **EZ Mode** and **Advanced Mode**. You can change modes from the **Exit** menu or from the **Exit/Advanced Mode** screen.

### 3.2.1 EZ Mode

By default, the EZ Mode screen appears when you enter the BIOS setup program. The EZ Mode provides you an overview of the basic system information, and allows you to select the display language, system performance mode and boot device priority. To access the Advanced Mode, click **Exit/Advanced Mode**, then select **Advanced Mode** or press <F7> hot key for the advanced BIOS settings.



The default screen for entering the BIOS setup program can be changed between EZ Mode or Advanced Mode. Refer to the Setup Mode item in section 3.8 **Boot menu** for details.

The screenshot shows the ASUS UEFI BIOS Utility in EZ Mode. The interface is dark-themed and displays various system metrics and settings. Callout boxes provide the following descriptions:

- Displays the CPU/motherboard temperature, CPU voltage output, CPU/chassis/power fan speed, and SATA information**: Points to the top-left section showing system information, CPU temperature (38°C), CPU voltage (1.136 V), and motherboard temperature (36°C).
- Selects the display language of the BIOS setup program**: Points to the 'English' language selection at the top.
- Creates storage RAID and configures system overclocking**: Points to the 'EZ System Tuning' section on the right.
- Displays the system properties of the selected mode. Click < or > to switch EZ System Tuning modes**: Points to the 'Normal' tuning mode selector.
- Enables or disables the SATA RAID mode for Intel Rapid Storage Technology**: Points to the 'SATA Information' section where RAID mode can be toggled.
- Displays the CPU Fan's speed. Click the button to manually tune the fans**: Points to the 'CPU FAN' section with a graph and a 'Manual Fan Tuning' button.
- Shows the bootable devices**: Points to the 'Boot Priority' list on the right.
- Saves the changes and resets the system**: Points to the 'Save & Exit(F10)' button at the bottom.
- Displays the Advanced mode menus**: Points to the 'Advanced Mode(F7)' button at the bottom.
- Selects the boot device priority**: Points to the 'Switch all' button in the 'Boot Priority' section.
- Loads optimized default settings**: Points to the 'Default(F5)' button at the bottom.



The boot device options vary depending on the devices you installed to the system.

### 3.2.2 Advanced Mode

The Advanced Mode provides advanced options for experienced end-users to configure the BIOS settings. The figure below shows an example of the Advanced Mode. Refer to the following sections for the detailed configurations.



To switch from EZ Mode to Advanced Mode, click **Advanced Mode** or press F7 hotkey.

The screenshot shows the UEFI BIOS Utility in Advanced Mode. The interface includes a menu bar at the top with options like My Favorites, Main, AI Tweaker, Advanced, Monitor, Boot, Tool, and Exit. The main area displays various configuration fields such as Target CPU Frequency, Target DRAM Frequency, and AI Overclock Tuner. A scroll bar is visible on the right side of the configuration fields. On the far right, there is a Hardware Monitor section showing CPU and Memory status. Labels with leader lines identify various parts of the interface: Menu bar, Language, MyFavorite, Q-Fan control, EZ Tuning Wizard, Quick Note, Hot Keys, Sub-menu item, Item description, Configuration fields, Scroll bar, Last modified settings, Last modified settings, Goes back to EZ Mode, and Displays the CPU/motherboard temperature, CPU and memory voltage output.

## Menu bar

The menu bar on top of the screen has the following main items:

<b>My Favorites</b>	For saving the frequently-used system settings and configuration.
<b>Main</b>	For changing the basic system configuration
<b>Ai Tweaker</b>	For changing the overclocking settings
<b>Advanced</b>	For changing the advanced system settings
<b>Monitor</b>	For displaying the system temperature, power status, and changing the fan settings.
<b>Boot</b>	For changing the system boot configuration
<b>Tool</b>	For configuring options for special functions
<b>Exit</b>	For selecting the exit options and loading default settings

## Menu items

The highlighted item on the menu bar displays the specific items for that menu. For example, selecting **Main** shows the Main menu items.

The other items (My Favorites, Ai Tweaker, Advanced, Monitor, Boot, Tool, and Exit) on the menu bar have their respective menu items.

## Submenu items

A greater than sign (>) before each item on any menu screen means that the item has a submenu. To display the submenu, select the item and press <Enter>.

## Language

This button above the menu bar contains the languages that you can select for your BIOS. Click this button to select the language that you want to display in your BIOS screen.

## MyFavorites (F3)

This button above the menu bar shows all BIOS items in a Tree Map setup. Select frequently-used BIOS settings and save it to MyFavorites menu.



---

Refer to section **3.3 My Favorites** for more information.

---

## Q-Fan Control (F6)

This button above the menu bar displays the current settings of your fans. Use this button to manually tweak the fans to your desired settings.



---

Refer to section **QFan Control** section for more information.

---

## EZ Tuning Wizard (F11)

This button above the menu bar allows you to view and tweak the overclocking settings of your system. It also allows you to change the motherboard's SATA mode from AHCI to RAID mode.



---

Refer to the **EZ Tuning Wizard** section for more information.

---

### Quick Note (F9)

This button above the menu bar allows you to key in notes of the activities that you have done in BIOS.



- 
- The Quick Note function does not support the following keyboard functions: delete, cut, copy and paste.
  - You can only use the alphanumeric characters to enter your notes.
- 

### Hot keys

This button above the menu bar contains the navigation keys for the BIOS setup program. Use the navigation keys to select items in the menu and change the settings.

### Scroll bar

A scroll bar appears on the right side of a menu screen when there are items that do not fit on the screen. Press the Up/Down arrow keys or <Page Up> / <Page Down> keys to display the other items on the screen.

### General help

At the top right corner of the menu screen is a brief description of the selected item. Use <F12> key to capture the BIOS screen and save it to the removable storage device.

### Configuration fields

These fields show the values for the menu items. If an item is user-configurable, you can change the value of the field opposite the item. You cannot select an item that is not user-configurable.

A configurable field is highlighted when selected. To change the value of a field, select it and press <Enter> to display a list of options.

### Last Modified button

This button shows the items that you last modified and saved in BIOS Setup.

### 3.2.3 Q-Fan Control

The Q-Fan Control allows you to set a fan profile or manually configure the operating speed of your CPU and chassis fans.



## Configuring fans manually

Select **Manual** from the list of profiles to manually configure your fans' operating speed.

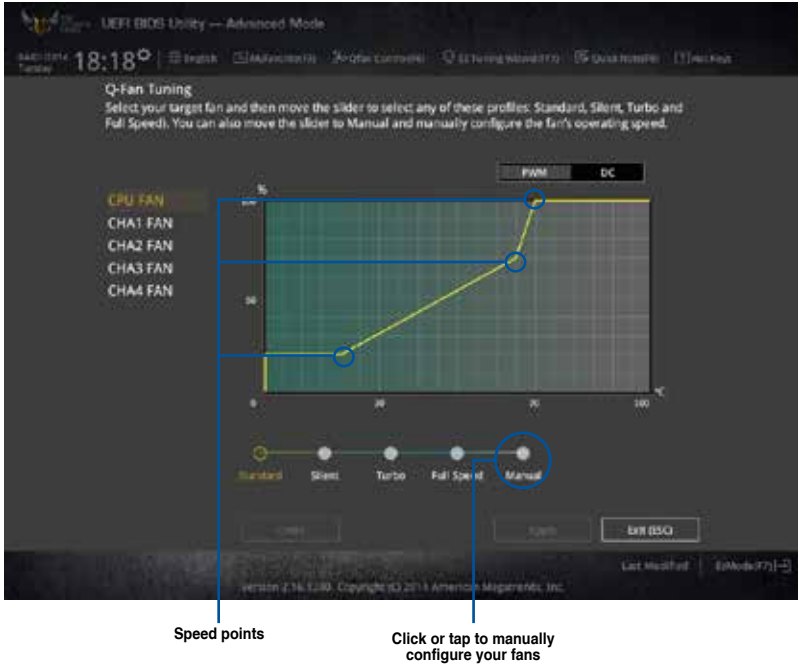

To configure your fans:

1. Select the fan that you want to configure and to view its current status.
2. Click and drag the speed points to adjust the fans' operating speed.
3. Click **Apply** to save the changes then click **Exit (ESC)**.



### 3.2.4 EZ Tuning Wizard

EZ Tuning Wizard allows you to overclock your CPU and DRAM, computer usage, and CPU fan to their best settings. You can also easily set RAID in your system using this feature.

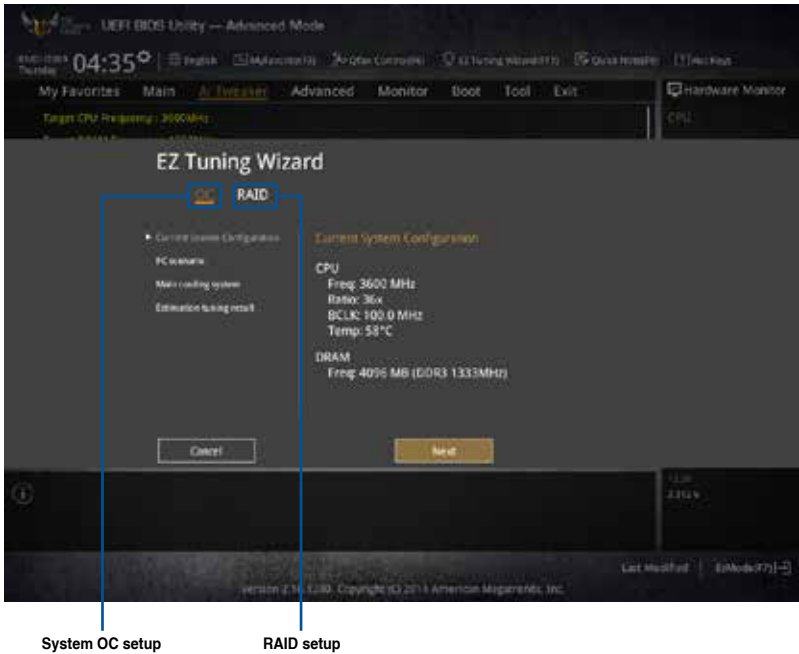

#### Tuning your system settings

To tune your settings:

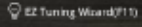
1. Press <F11> on your keyboard or click  from the BIOS screen to open EZ Tuning Wizard screen, then click **Next**.
2. Select a PC scenario **Daily Computing** or **Gaming/Media Editing**, then click **Next**.
3. Select the CPU fan type (**Box cooler**, **Tower cooler**, or **Water cooler**) that you installed then click **Next**.



If you are not sure of the CPU fan type, click **I'm not sure**. The system automatically detects the CPU fan type.

4. Click **Next** then click **Yes** to confirm auto-tuning.

### 3.3 My Favorites

My Favorites is your personal space where you can easily save and access your favorite BIOS items.



## Adding items to My Favorites

To add BIOS items:

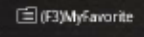
1. Press <F3> on your keyboard or click  from the BIOS screen to open Setup Tree Map screen.
2. On the Setup Tree Map screen, select the BIOS items that you want to save in MyFavorites screen.

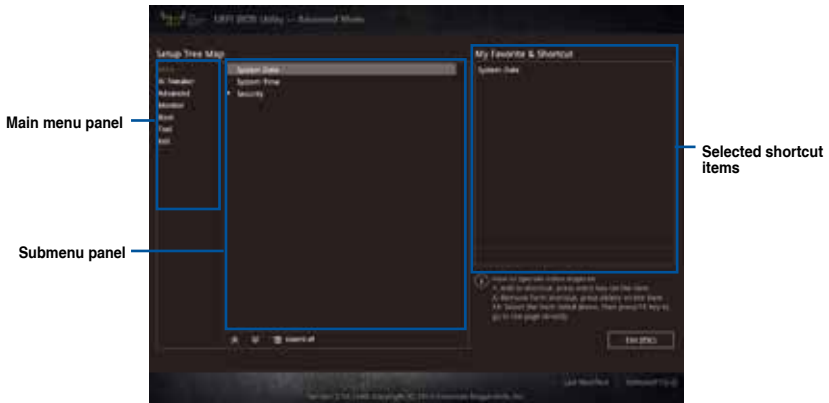

3. Select an item from main menu panel, then click the submenu that you want to save as favorite from the submenu panel and tap or click  or press <Enter> on your keyboard.



You cannot add the following items to My Favorite items:

- Items with submenu options
- User-managed items such as language and boot order
- Configuration items such as Memory SPD Information, system time and date.

4. Click **Exit (ESC)** or press <esc> key to close Setup Tree Map screen.
5. Go to My Favorites menu to view the saved BIOS items.

### 3.4 Main menu

The Main menu screen appears when you enter the Advanced Mode of the BIOS Setup program. The Main menu provides you an overview of the basic system information, and allows you to set the system date, time, language, and security settings.

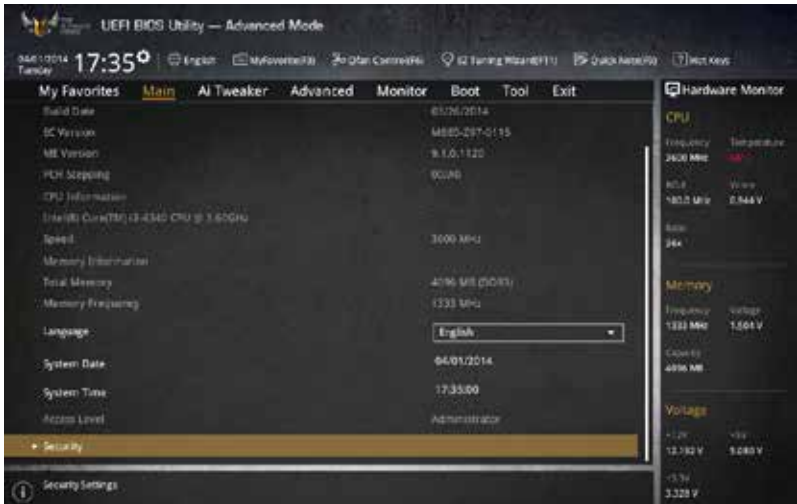

#### Security

The Security menu items allow you to change the system security settings.

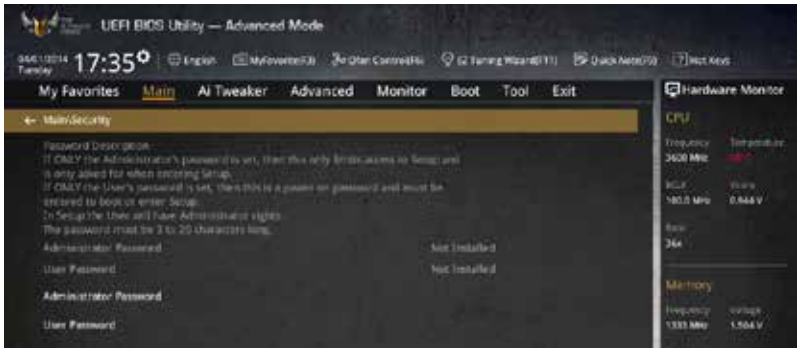

- If you have forgotten your BIOS password, erase the CMOS Real Time Clock (RTC) RAM to clear the BIOS password. See the **Onboard buttons and switches** section for information on how to erase the RTC RAM via the Clear CMOS button.
- The Administrator or User Password items on top of the screen show the default **[Not Installed]**. After you set a password, these items show **[Installed]**.

## Administrator Password

If you have set an administrator password, we recommend that you enter the administrator password for accessing the system. Otherwise, you might be able to see or change only selected fields in the BIOS setup program.

### To set an administrator password:

1. Select the **Administrator Password** item and press <Enter>.
2. From the **Create New Password** box, key in a password, then press <Enter>.
3. Confirm the password when prompted.

### To change an administrator password:

1. Select the **Administrator Password** item and press <Enter>.
2. From the **Enter Current Password** box, key in the current password, then press <Enter>.
3. From the **Create New Password** box, key in a new password, then press <Enter>.
4. Confirm the password when prompted.

To clear the administrator password, follow the same steps as in changing an administrator password, but press <Enter> when prompted to create/confirm the password. After you clear the password, the **Administrator Password** item on top of the screen shows **Not Installed**.

## User Password

If you have set a user password, you must enter the user password for accessing the system. The User Password item on top of the screen shows the default Not Installed. After you set a password, this item shows Installed.

### To set a user password:

1. Select the **User Password** item and press <Enter>.
2. From the **Create New Password** box, key in a password, then press <Enter>.
3. Confirm the password when prompted.

### To change a user password:

1. Select the **User Password** item and press <Enter>.
2. From the **Enter Current Password** box, key in the current password, then press <Enter>.
3. From the **Create New Password** box, key in a new password, then press <Enter>.
4. Confirm the password when prompted.

To clear the user password, follow the same steps as in changing a user password, but press <Enter> when prompted to create/confirm the password. After you clear the password, the **User Password** item on top of the screen shows **Not Installed**.

## 3.5 Ai Tweaker menu

The Ai Tweaker menu items allow you to configure overclocking-related items.



Be cautious when changing the settings of the Ai Tweaker menu items. Incorrect field values can cause the system to malfunction.



The configuration options for this section vary depending on the CPU and DIMM model you installed on the motherboard.

Scroll down to display other BIOS items.

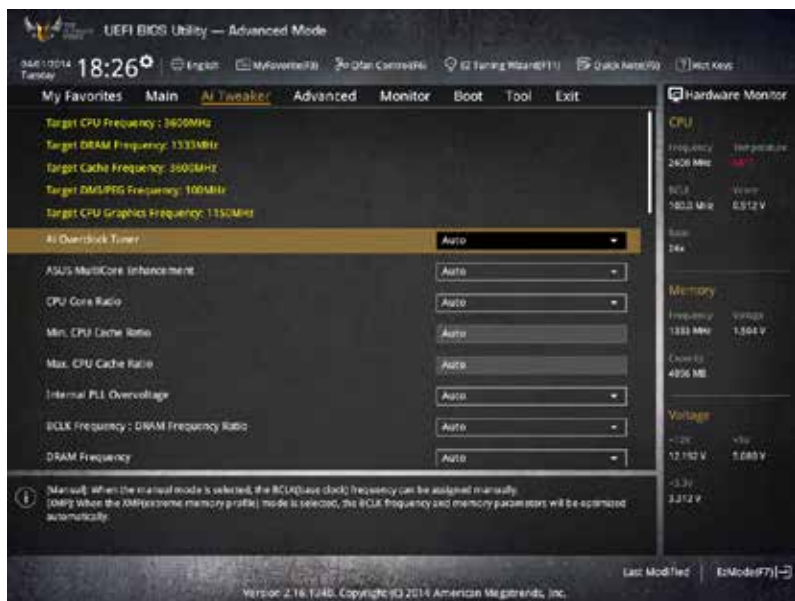

## Ai Overclock Tuner [Auto]

This item allows you to select the CPU overclocking options to achieve the desired CPU internal frequency.

Configuration options: [Auto] [Manual] [XMP]



---

The following items appear only when you set the Ai Overclocking Tuner to **[Manual]** or **[XMP]**.

---

### Filter PLL [Auto]

Set this item to high BCLK (base clock) mode when using a very high BCLK to improve overclocking capability.

Configuration options: [Auto] [Low BCLK mode] [High BCLK mode]

### BCLK Frequency [100]

This item allows you to set the BCLK (base clock) frequency to enhance the system performance. Use the <+> or <-> to adjust the value. The values range from 80.0 MHz to 300.0 MHz.



---

We recommend you to set the value based on the CPU specification, as high BCLK frequencies may damage the CPU permanently.

---

### Initial BCLK Frequency [Auto]

This item allows you to start overclocking the system from the initial BCLK (base clock) frequency to the assigned BCLK frequency. Use the <+> or <-> to adjust the value.

The value ranges depend on the value you set on BCLK Frequency.

## ASUS MultiCore Enhancement [Auto]

[Auto] This item allows you to maximize the overlocking performance optimized by ASUS core ratio settings.

[Disabled] This item allows you to set to default core ratio settings.

## CPU Core Ratio [Auto]

This item allows you to set the CPU core ratio limit per core or synchronize automatically to all cores.

Configuration options: [Auto] [Sync All Cores] [Per Core]

When the CPU Core Ratio is set to [Per Core], the following items appear:

### 1-Core Ratio Limit [Auto]

Select **[Auto]** to apply the CPU default Turbo Ratio setting or manually assign a 1-Core Limit value that must be higher than or equal to the 2-Core Ratio Limit.

### 2-Core Ratio Limit [Auto]

Select **[Auto]** to apply the CPU default Turbo Ratio setting or manually assign a 2-Core Limit value that must be higher than or equal to the 3-Core Ratio Limit.



---

If you assign a value for 2-Core Ratio Limit, do not set the 1-Core Ratio Limit to **[Auto]**.

---

### **Min. CPU Cache Ratio [Auto]**

This item allows you to set the minimum possible ratio on the Uncore part of the processor. Use the <+> or <-> keys to adjust the value. The values depend on the CPU installed.

### **Max. CPU Cache Ratio [Auto]**

This item allows you to set the maximum possible ratio on the Uncore part of the processor. Use the <+> or <-> keys to adjust the value. The values depend on the CPU installed.

### **Internal PLL Overvoltage [Auto]**

This item allows you to enable the internal PLL Overvoltage for K-SKU CPUs to get the extreme overclocking capability.

Configuration options: [Auto] [Enabled] [Disabled]

### **BCLK Frequency: DRAM Frequency Ratio [Auto]**

[Auto] The BCLK frequency to DRAM frequency ratio is set to the optimized setting.

[100:133] The BCLK frequency to DRAM frequency ratio is set to 100:133.

[100:100] The BCLK frequency to DRAM frequency ratio is set to 100:100.

### **DRAM Frequency [Auto]**

This item allows you to set the memory operating frequency. The configurable options vary with the BCLK (base clock) frequency setting. Select the auto mode to apply the optimized setting.

Configuration options: [DDR3-800MHz] [DDR3-1066MHz] [DDR3-1333MHz] [DDR3-1400MHz] [DDR3-1600MHz] [DDR3-1800MHz] [DDR3-1866MHz] [DDR3-2000MHz] [DDR3-2133MHz] [DDR3-2200MHz] [DDR3-2400MHz] [DDR3-2600MHz] [DDR3-2666MHz] [DDR3-2800MHz] [DDR3-2933MHz] [DDR3-3000MHz] [DDR3-3200MHz] [DDR3-3400MHz]

### **OC Tuner [Keep Current Settings]**

This item allows you to automatically overclock the CPU and DRAM frequencies and voltage for an enhanced system performance. It also accelerates the CPU graphics performance to the extreme depending on the CPU graphics loading.

Configuration options: [Keep Current Settings] [Ratio First] [BCLK First]

---

Ensure that you installed an efficient CPU fan for CPU and graphics loading before selecting either **[BCLK First]** or **[Ratio First]**. To keep the current overclocking tuner status, select **[Keep Current Settings]**.

---

### **EPU Power Saving Mode [Disabled]**

The ASUS EPU (Energy Processing Unit) sets the CPU in its minimum power consumption settings. Enable this item to set lower CPU VCCIN and Vcore voltages and achieve the best energy saving condition.

Configuration options: [Disabled] [Enabled]



## DRAM Timing Control

The subitems in this menu allow you to set the DRAM timing control features. Use the <+> or <-> keys to adjust the value. To restore the default setting, type [auto] using the keyboard and press the <Enter> key.



---

Changing the values in this menu may cause the system to become unstable! If this happens, revert to the default settings.

---

### Primary Timings

#### **DRAM CAS# Latency [Auto]**

Configuration options: [Auto] [1] – [31]

#### **DRAM RAS# to CAS# Delay [Auto]**

Configuration options: [Auto] [1] – [31]

#### **DRAM RAS# PRE Time [Auto]**

Configuration options: [Auto] [1] – [31]

#### **DRAM RAS# ACT Time [Auto]**

Configuration options: [Auto] [1] – [63]

#### **DRAM Command Rate [Auto]**

Configuration options: [Auto] [1] – [2]

### Secondary Timings

#### **DRAM RAS# to RAS# Delay [Auto]**

Configuration options: [Auto] [1] – [15]

#### **DRAM REF Cycle Time [Auto]**

Configuration options: [Auto] [1] – [511]

#### **DRAM Refresh Interval [Auto]**

Configuration options: [Auto] [1] – [65535]

#### **DRAM WRITE Recovery Time [Auto]**

Configuration options: [Auto] [1] – [16]

#### **DRAM READ to PRE Time [Auto]**

Configuration options: [Auto] [1] – [15]

#### **DRAM FOUR ACT WIN Time [Auto]**

Configuration options: [Auto] [1] – [255]

#### **DRAM WRITE to READ Delay [Auto]**

Configuration options: [Auto] [1] – [15]

#### **DRAM CKE Minimum Pulse Width [Auto]**

Configuration options: [Auto] [1] – [15]

#### **DRAM CAS# Write Latency [Auto]**

Configuration options: [Auto] [1] – [31]

## RTL IOL control

- DRAM RTL Initial Value [Auto]***  
Configuration options: [Auto] [1] - [63]
- DRAM RTL (CHA\_R0D0) [Auto]***  
Configuration options: [Auto] [1] - [63]
- DRAM RTL (CHA\_R0D1) [Auto]***  
Configuration options: [Auto] [1] - [63]
- DRAM RTL (CHA\_R1D0) [Auto]***  
Configuration options: [Auto] [1] - [63]
- DRAM RTL (CHA\_R1D1) [Auto]***  
Configuration options: [Auto] [1] - [63]
- DRAM RTL (CHB\_R0D0) [Auto]***  
Configuration options: [Auto] [1] - [63]
- DRAM RTL (CHB\_R0D1) [Auto]***  
Configuration options: [Auto] [1] - [63]
- DRAM RTL (CHB\_R1D0) [Auto]***  
Configuration options: [Auto] [1] - [63]
- DRAM RTL (CHB\_R1D1) [Auto]***  
Configuration options: [Auto] [1] - [63]
- DRAM IO-L (CHA\_R0D0) [Auto]***  
Configuration options: [Auto] [1] - [15]
- DRAM IO-L (CHA\_R0D1) [Auto]***  
Configuration options: [Auto] [1] - [15]
- DRAM IO-L (CHA\_R1D0) [Auto]***  
Configuration options: [Auto] [1] - [15]
- DRAM IO-L (CHA\_R1D1) [Auto]***  
Configuration options: [Auto] [1] - [15]
- DRAM IO-L (CHB\_R0D0) [Auto]***  
Configuration options: [Auto] [1] - [15]
- DRAM IO-L (CHB\_R0D1) [Auto]***  
Configuration options: [Auto] [1] - [15]
- DRAM IO-L (CHB\_R1D0) [Auto]***  
Configuration options: [Auto] [1] - [15]
- DRAM IO-L (CHB\_R1D1) [Auto]***  
Configuration options: [Auto] [1] - [15]

### **Third Timings**

#### **tRDRD [Auto]**

Configuration options: [Auto] [1] - [7]

#### **tRDRD\_dr [Auto]**

Configuration options: [Auto] [1] - [15]

#### **tRDRD\_dd [Auto]**

Configuration options: [Auto] [1] - [15]

#### **tWRRD [Auto]**

Configuration options: [Auto] [1] - [63]

#### **tWRRD\_dr [Auto]**

Configuration options: [Auto] [1] - [15]

#### **tWRRD\_dd [Auto]**

Configuration options: [Auto] [1] - [15]

#### **tWRWR [Auto]**

Configuration options: [Auto] [1] - [7]

#### **tWRWR\_dr [Auto]**

Configuration options: [Auto] [1] - [15]

#### **tWRWR\_dd [Auto]**

Configuration options: [Auto] [1] - [15]

#### **Dec\_WRD [Auto]**

Configuration options: [Auto] [0] [1]

#### **tRDWR [Auto]**

Configuration options: [Auto] [1] - [31]

#### **tRDWR\_dr [Auto]**

Configuration options: [Auto] [1] - [31]

#### **tRDWR\_dd [Auto]**

Configuration options: [Auto] [1] - [31]

## MISC

### MRC Fast Boot [Auto]

This item allows you to enable, disable or automatically set the MRC fast boot.

Configuration options: [Auto] [Enabled] [Disabled]

### DRAM CLK Period [Auto]

This item allows you to set a DRAM clock period.

Configuration options: [Auto] [1] – [14]

### Channel A/B DIMM Control [Enable Both DIMMs]

This item allows you to enable or disable the DIMMs on channels A and B.

Configuration options: [Enable Both DIMMS] [Disable DIMM0] [Disable DIMM1]

[Disable Both DIMMS]

### Scramble Setting [Optimized (ASUS)]

This item allows you to set the optimized mode to enhance system stability.

Configuration options: [Optimized (ASUS)] [Default (MRC)]

### MCH Full Check [Auto]

Enable this item to enhance the stability of your system. Disable this item to enhance the DRAM overclocking capability.

Configuration options: [Auto] [Enabled] [Disabled]

## External DIGI+ Power Control

### CPU Load-line Calibration [Auto]

Load-line is defined by Intel® specification and affects CPU power voltage. The CPU working voltage decreases proportionally to CPU loading. Higher load-line calibration could get higher voltage and good overclocking performance, but increases the CPU and VRM thermal conditions. Select from levels 1 to 9 to adjust the CPU power voltage from 0% to 125%.

Configuration options [Auto] [Level 1] - [Level 9]



---

The actual performance boost may vary depending on your CPU specification.

---



---

DO NOT remove the thermal module. The thermal conditions should be monitored.

---

### CPU VRM Switching Frequency [Auto]

This item affects the VRM transient response speed and the component thermal production. Select [Manual] to configure a higher frequency for a quicker transient response speed.

Configuration options: [Auto] [Manual]



---

DO NOT remove the thermal module. The thermal conditions should be monitored.

---



---

The following item appears only when you set the CPU VRM Switching Frequency to **[Manual]**.

---

#### **Fixed CPU VRM Switching Frequency (KHz) [300]**

This item allows you to set a higher frequency for a quicker transient response speed. Use the <+> or <-> to adjust the value. The values range from 300 KHz to 500 KHz with an interval of 50 KHz.

#### **VRM Spread Spectrum [Disabled]**

This item allows to enhance the system stability.

Configuration options: [Disabled] [Enabled]

#### **CPU Power Phase Control [Auto]**

This item allows you to set the power phase control of the CPU.

Configuration options: [Auto] [Standard] [Optimized] [Extreme]

#### **CPU Power Duty Control [T.Probe]**

DIGI + VRM Duty Control adjusts the current of every VRM phase and the thermal conditions of every phase component.

[T. Probe]                      Select to maintain the VRM thermal balance.

[Extreme]                        Select to maintain the current VRM balance.



---

DO NOT remove the thermal module. The thermal conditions should be monitored.

---

#### **CPU Current Capability [Auto]**

This item provides a total power range for CPU overclocking. A higher value setting provides higher power consumption delivery and extends the overclocking frequency range simultaneously.

Configuration options: [Auto] [100%] [110%] [120%] [130%] [140%]

#### **DRAM Current Capability [100%]**

This item adjusts the total power range for DRAM overclocking. Set a higher value to provide a wider total power range and extends the overclocking frequency range simultaneously.

Configuration options: [100%] [110%] [120%] [130%]

#### **DRAM Switching Frequency [Auto]**

This item affects the overclocking range and system stability. Set this item to **[Manual]** to manually set a fixed DRAM switching frequency for an increased overclocking range or enhanced system stability.



---

The following item appears only when you set the DRAM Switching Frequency to **[Manual]**.

---

#### **Fixed DRAM Switching Frequency (KHz) [300]**

This item allows you to set a higher frequency for an increased overclocking range or a lower frequency for an enhanced system stability. Use the <+> or <-> to adjust the value. The values range from 300 KHz to 500 KHz with an interval of 50 KHz.

### DRAM Power Phase Control [Auto]

[Optimized] Set to the ASUS optimized phase tuning profile.

[Extreme] Set to the full phase mode.



DO NOT remove the thermal module when setting this item to **[Extreme]**. The thermal conditions should be monitored.

## Internal CPU Power Management

The subitems in this menu allow you to set the CPU ratio and their features.

### Enhanced Intel SpeedStep Technology [Enabled]

This item allows the operating system to dynamically adjust the processor voltage and cores frequency, resulting to a decreased average power consumption and decreased average heat production.

Configuration options: [Disabled] [Enabled]

### Turbo Mode Parameters

#### Long Duration Package Power Limit [Auto]

Allows you to limit the Turbo Ratio's time duration that exceeds the TDP (Thermal Design Power) for maximum performance. Use the <+> or <-> keys to adjust the value. The values range from 1 W to 4096 W.

#### Package Power Time Window [Auto]

Also known as Power Limit 1, this item allows you to maintain the time window for Turbo Ratio over TDP (Thermal Design Power). Use the <+> or <-> keys to adjust the value. The values range from 1 to 127 in seconds.

#### Short Duration Package Power Limit [Auto]

Also known as Power Limit 2, this item allows you to provide rapid protection when the package power exceeds the Power Limit 1. Use the <+> or <-> keys to adjust the value. The values range from 1 W to 4096 W.

#### CPU Integrated VR Current Limit [Auto]

Allows you to set a higher current limit to prevent frequency and power throttling when overclocking. Use the <+> or <-> keys to adjust the value. The values range from 0.125 to 1023.875 with a 0.125 interval.

### CPU Internal Power Switching Frequency

#### Frequency Tuning Mode [Auto]

This item allows you to increase or decrease the switching frequency of the internal regulator. Decrease the switching frequency to reduce the power consumption or increase the switching frequency to enhance voltage stability. When this item is set to [+ ] or [- ], the Frequency Tuning Offset appears that allows you to set its value from 0% to 6%.

## CPU Internal Power Fault Control

### Thermal Feedback [Auto]

Allows your system to take precautionary actions to protect the CPU when the thermal condition of the external regulator exceeds the threshold.

Configuration options: [Auto] [Disabled] [Enabled]

### CPU Integrated VR Fault Management [Auto]

Disable this item to prevent tripping the Fully Integrated Voltage Regulator when doing over-voltage. We recommend you to disable this item when overclocking.

Configuration options: [Auto] [Disabled] [Enabled]

## CPU Internal Power Configuration

### CPU Integrated VR Efficiency Management [Auto]

This item allows you to improve the power rating when the CPU is in low power state, or make the FIVR (fully integrated voltage regulator work in high performance at all times.

Configuration options: [Auto] [High Performance] [Balanced]

### Power Decay Mode [Auto]

This item allows your system to improve the power saving mode on the Fully Integrated Voltage Regulator as the processor goes into low current state.

Configuration options: [Auto] [Disabled] [Enabled]

### Idle Power-in Response [Auto]

This item allows you to set the slew rate for the Fully Integrated Voltage Regulator when it enters manual override mode.

Configuration options: [Auto] [Regular] [Fast]

### Idle Power-out Response [Auto]

This item allows you to set the slew rate for the Fully Integrated Voltage Regulator when it exits manual override mode.

Configuration options: [Auto] [Regular] [Fast]

### Power Current Slope [Auto]

This item allows you to enhance the power saving condition or the system overclocking capability. Select a higher power current slope levels for power saving enhancement or lower power current slope levels for system overclocking enhancement.

Configuration options: [Auto] [LEVEL -4] - [LEVEL 4]

### Power Current Offset [Auto]

This item allows you to increase or decrease the output current sensed by the CPU. It finds the balance between optimal regulating while staying below the current threshold.

Configuration options: [Auto] [100%] [87.5%] [75.0%] [62.5%] [50.0%] [37.5%] [25.0%] [12.5%] [0%] [-12.5%] [-25.0%] [-37.5%] [-50.0%] [-62.5%] [-75.0%] [-87.5%] [-100%]

### Power Fast Ramp Response [Auto]

This item allows you to enhance the response of the CPU voltage regulator during the load transients. Use the <+> or <-> to adjust the value. The values range from 0.00 to 1.50.

Configuration options: [Auto] [0.00] - [1.50]

## CPU Internal Power Saving Control

### Power Saving Level 1 Threshold [Auto]

Lower value provides sufficient overclocking tolerance to enlarge the overclocking potential. Higher value provides better power-saving condition. Use <+> or <-> key to adjust the value. The values range from 0 A to 80 A at 1 A increment.

### Power Saving Level 2 Threshold [Auto]

Lower value provides sufficient overclocking tolerance to enlarge the overclocking potential. Higher value provides better power-saving condition. Use <+> or <-> key to adjust the value. The values range from 0 A to 50 A at 1 A increment.

### Power Saving Level 3 Threshold [Auto]

Lower value provides sufficient overclocking tolerance to enlarge the overclocking potential. Higher value provides better power-saving condition. Use <+> or <-> key to adjust the value. The values range from 0 A to 30 A at 1A increment.

## Extreme Over-voltage [Disabled]

This item allows you to set higher voltages for overclocking. When you enable this item, you can choose a high level voltage to overclock, but does not guarantee the CPU life.

Configuration options: [Disabled] [Enabled]



---

You can only enable this item when the onboard OC\_CPU jumper is set to ON. Refer to the **Jumpers** section of this user guide for more details.

---

## CPU Core Voltage [Auto]

This item allows you to configure the amount of voltage fed to the CPU cores. Increase the voltage when setting a high Core Frequency value.

Configuration options: [Auto] [Manual Mode] [Offset Mode]



---

The following item appears only when you set the CPU Core Voltage to **[Manual Mode]**.

---

### CPU Core Voltage Override [Auto]

This item allows you to set the CPU Core Voltage override. Use the <+> or <-> keys to adjust the value. The values range from 0.001V to 1.920 V with a 0.001 V interval.



---

The following items appear only when you set the CPU Core Voltage to **[Offset Mode]**.

---

### Offset Mode Sign [+]

[+] To offset the voltage by a positive value.

[-] To offset the voltage by a negative value.

### CPU Core Voltage Offset

Use the <+> or <-> keys to adjust the value. The values range from 0.001 V to 0.999 V with a 0.001 V interval.



## CPU Cache Voltage [Auto]

This item allows you to set the amount of voltage fed to the CPU uncores including its cache. Increase the voltage when setting a high CPU cache frequency.

Configuration options: [Auto] [Manual Mode] [Offset Mode]



---

The following item appears only when you set the CPU Cache Voltage to **[Manual Mode]**.

---

### CPU Cache Voltage Override [Auto]

This item allows you to set the CPU Cache Voltage override. By default, this item takes the standard value of the installed CPU. You can use the <+> or <-> keys to adjust the value. The values range from 0.001V to 1.920 V with a 0.001 V interval.



---

The following items appear only when you set the CPU Core Voltage to **[Offset Mode]**.

---

### Offset Mode Sign [+]

[+] To offset the voltage by a positive value.

[-] To offset the voltage by a negative value.

#### **CPU Cache Voltage Offset**

Allows you to set the CPU cache voltage offset. By default, this item takes the standard value of the installed CPU. You can use the <+> or <-> keys to adjust the value. The values range from 0.001V to 0.999 V with a 0.001 V interval.

## CPU System Agent Voltage Offset Mode Sign [+]

[+] To offset the voltage by a positive value.

[-] To offset the voltage by a negative value.

### CPU System Agent Voltage Offset [Auto]

This item allows you to set the amount of voltage fed to the system agent of the CPU including its PCIe controller and the PCU (power control unit). Increase the voltage to enhance the overclocking capability.

You can use the <+> or <-> keys to adjust the value. The values range from 0.001 V to 0.999 V with a 0.001 V interval.

## CPU Analog I/O Voltage Offset Mode Sign [+]

[+] To offset the voltage by a positive value.

[-] To offset the voltage by a negative value.

### CPU Analog I/O Voltage Offset [Auto]

This item allows you to set the amount of voltage fed to the analog portion of the I/O on the CPU. By default, this item takes the standard value of the installed CPU. Increase the amount of voltage to enhance the overclocking capability.

You can use the <+> or <-> keys to adjust the value. The values range from 0.001 V to 0.999 V with a 0.001 V interval.

## CPU Digital I/O Voltage Offset Mode Sign [+]

[+] To offset the voltage by a positive value.

[-] To offset the voltage by a negative value.

### CPU Digital I/O Voltage Offset [Auto]

This item allows you to set the amount of voltage fed to the digital portion of the I/O on the processor. By default, this item takes the standard value of the installed CPU. Increase the amount of voltage to enhance the overclocking capability.

You can use the <+> or <-> keys to adjust the value. The values range from 0.001 V to 0.999 V with a 0.001 V interval.

## SVID Support [Auto]

Set this item to **[Enabled]** when overclocking your system. Disabling this item stops the CPU from communicating with the external voltage regulator.

Configuration options: [Auto] [Disabled] [Enabled]



---

The following item appears only when you set SVID Support to **[Enabled]**.

---

### SVID Voltage Override [Auto]

This item allows you to set the SVID Voltage override. By default, this item takes the standard value of the installed CPU. You can use the <+> or <-> keys to adjust the value. The values range from 0.001V to 2.440 V with a 0.001 V interval.

## CPU Input Voltage [Auto]

This item allows you to set an input voltage for the CPU by the external voltage regulator. By default, this item takes the standard value of the installed CPU. You can use the <+> or <-> keys to adjust the value. The values range from 0.800 V to 2.700 V with a 0.010 V interval.

## DRAM Voltage [Auto]

This item allows you to set the DRAM voltage. You can use the <+> or <-> keys to adjust the value. The values range from 1.20 V to 1.92 V with a 0.005 V interval.



---

According to Intel® CPU specifications, DIMMs with voltage requirement over 1.65 V may damage the CPU permanently. We recommend that you install the DIMMs with the voltage requirement below 1.65 V.

---

## PCH Core Voltage [Auto]

This item allows you to set the Core voltage for the PCH (Platform Controller Hub). You can use the <+> or <-> keys to adjust the value. The values range from 0.70 V to 1.80 V with a 0.0125 V interval.



- The values of the CPU PLL Voltage, CPU Manual Voltage, CPU Offset Voltage, iGPU Manual Voltage, iGPU Offset Voltage, DRAM Voltage, VCCSA Voltage, VCCIO Voltage, and PCH Voltage items are labeled in different color, indicating the risk levels of high voltage settings.
  - The system may need better cooling system for a more stable performance under high voltage settings.
-

### **PCH VLX Voltage [Auto]**

This item allows you to set the I/O voltage on the PCH (Platform Controller Hub). You can use the <+> or <-> keys to adjust the value. The values range from 1.2000 V to 2.0000 V with a 0.0125 V interval.

### **VTTDDR Voltage [Auto]**

This item allows you to set the termination voltage for the system memory. You can use the <+> or <-> keys to adjust the value. The values range from 0.6000 V to 1.0000 V with a 0.0125 V interval.

### **DRAM CTRL REF Voltage [Auto]**

This item allows you to set the DRAM reference voltage on the control lines from the memory bus. You can use the <+> or <-> keys to adjust the value. The values range from 0.39500x to 0.63000x with a 0.00500x interval.



---

To set a value for the DRAM reference voltage, we recommend you to set a value close to the standard value which is 0.500000x.

---

### **DRAM DATA REF Voltage on CHA/CHB [Auto]**

This item allows you to set the DRAM reference voltage on the data lines on Channels A and B. You can use the <+> or <-> keys to adjust the value. The values range from 0.39500x to 0.63000x with a 0.00500x interval.



---

To set a value for the DRAM reference voltage, we recommend you to set a value close to the standard value which is 0.500000x.

---

### **Clock Crossing Boot Voltage/ Clock Crossing Reset Voltage / Clock Crossing Voltage [Auto]**

This item allows you to increase the value of the clock crossing voltage boot when the rising edge of the BCLK DN is equal to the falling edge of the BCLK D+. You can use the <+> or <-> keys to adjust the value. The values range from 0.1 V to 1.9 V with a 0.00625 V interval.

### **CPU Spread Spectrum [Auto]**

This item allows you to enhance the BCLK overclocking capability or reduce the EMI (electromagnetic disturbance) generated by the BCLK. Set this item to [Enabled] for EMI reduction, or set this item to [Disabled] to enhance BCLK overclocking.

Configuration options: [Auto] [Disabled] [Enabled]

### 3.6 Advanced menu

The Advanced menu items allow you to change the settings for the CPU and other system devices.



Be cautious when changing the settings of the Advanced menu items. Incorrect field values can cause the system to malfunction.



### 3.6.1 CPU Configuration

The items in this menu show the CPU-related information that the BIOS automatically detects.



The items in this menu may vary based on the CPU installed.



#### Intel Adaptive Thermal Monitor [Enabled]

This item allows you to protect the CPU by decreasing its frequency as it reaches the thermal throttle point. The thermal monitor includes TM1 (Thermal monitor 1), TM2 (Thermal monitor 2), and EMTTM (Enhanced Multi-threaded Thermal Monitoring).

Configuration options: [Disabled] [Enabled]

#### Hyper-threading [Enabled]

This item allows the processor to appear as two logical processors, allowing the operating system to schedule two threads or processes simultaneously.

Configuration options: [Disabled] [Enabled]

#### Active Processor Cores [All]

This item allows you to select the number of CPU cores to activate in each processor package.

Configuration options: [All] [1] [2] [3]

#### Limit CPUID Maximum [Disabled]

When set to [Enabled], this item allows the legacy OS to boot even without support for CPUs with extended CPUID functions.

Configuration options: [Disabled] [Enabled]

### **Execute Disable Bit [Enabled]**

Execute Disable prevents certain classes of malicious buffer overflow attacks when combined with a supporting OS (SuSE Linux 9.2, RedHat Enterprise 3 Update 3).

Configuration options: [Disabled] [Enabled]

### **Intel Virtualization Technology [Disabled]**

When set to [Enabled], a VMM can utilize the additional hardware capabilities provided by Vanderpool Technology.

Configuration options: [Disabled] [Enabled]

### **Hardware Prefetcher(L2 Cache) [Enabled]**

This item allows the CPU to prefetch commands and data in the L2 cache, reduces the DRAM loading time and improves the system performance.

Configuration options: [Disabled] [Enabled]

### **Adjacent Cache Line Prefetcher [Enabled]**

This item allows the mid level cache (L2) to prefetch adjacent cache lines, reducing the DRAM loading time and improves the system performance.

Configuration options: [Disabled] [Enabled]

### **Boot Performance Mode [Max Non-Turbo Performance]**

This item allows you to select the CPU performance state during system boot before the operating system takes control. The CPU runs at a selected performance ratio based on CPU configuration.

Configuration options: [Max Non-Turbo Performance] [Max Battery] [Turbo Performance]

### **Dynamic Storage Accelerator [Disabled]**

This item allows you to accelerate the performance of the SSDs (Solid-State Drives) by dynamically adjusting the power management during heavy multitasking.

Configuration options: [Enabled] [Disabled]

### **CPU Power Management Configuration**

This item allows you to manage and configure the CPU's power.

#### **Enhanced Intel SpeedStep Technology [Enabled]**

This item allows your system to adjust the CPU's voltage and cores frequency, resulting in decreased power consumption and heat production.

[Disabled]      The CPU runs at its default speed.

[Enabled]      The system controls the CPU speed.

## CPU C-States [Auto]

This item allows you to set the power saving of the CPU states.

Configuration options: [Auto] [Disabled] [Enabled]



---

The following items appear only when you set the CPU states to **[Enabled]**.

---

### ***Enhanced C1 State [Enabled]***

This item allows your CPU to reduce power consumption when the system is in idle mode.

Configuration options: [Enabled] [Disabled]

### ***CPU C3 Report [Enabled]***

This item allows you to disable or enable the CPU C3 report to the operating system.

Configuration options: [Enabled] [Disabled]

### ***CPU C6 Report [Enabled]***

This item allows you to disable or enable the CPU C6 report to the operating system.

Configuration options: [Enabled] [Disabled]

### ***C6 Latency [Short]***

This item allows you to set the duration of C6 latency for C6 state.

Configuration options: [Short] [Long]

### ***CPU C7 Report [CPU C7s]***

This item allows you to disable or enable the CPU C7 report to the operating system.

Configuration options: [Disabled] [CPU C7] [CPU C7s]

### ***C7 Latency [Long]***

This item allows you to set the duration of C7 latency for C7 state.

Configuration options: [Short] [Long]

### ***Package C-States Support [Auto]***

This item allows you to set the a C-state support for the CPU package.

Configuration options: [Auto] [Enabled] [C0/C1] [C2] [C3] [C6] [CPU C7] [CPU C7s]

## 3.6.2 PCH Configuration

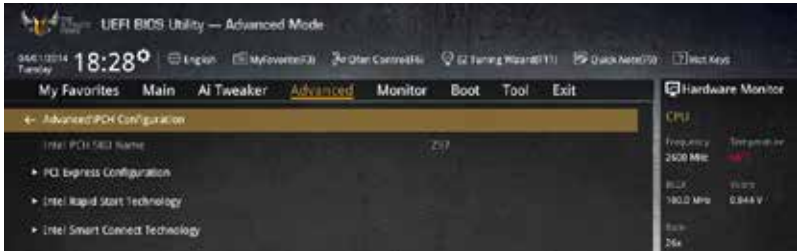

### PCI Express Configuration

This item allows you to configure the PCI Express slots.

#### PCIe Speed [Auto]

This item allows your system to automatically select the PCI Express port speed. When set to [Gen1], the PCI-E port runs at PCI-E 1.0 speed. When set to [Gen2], the PCI-E port runs at PCI-E 2.0 speed.

Configuration options: [Auto] [Gen1] [Gen2]

#### Intel Rapid Start Technology [Disabled]

This item allows you to enable or disable Intel® Rapid Start Technology.

Configuration options: [Enabled] [Disabled]



---

The following items appear only when you set the Intel® Rapid Start Technology to [Enabled].

---

#### Entry on S3 RTC Wake [Enabled]

The system automatically wakes up and set to Rapid Start Technology S3 mode.

Configuration options: [Enabled] [Disabled]

#### Entry After [0]

This item allows you to set the RTC wake-up timer at S3 entry. The time ranges from 0 minute (immediately) to 120 minutes.

#### Active Page Threshold Support [Enabled]

The system automatically goes into sleep mode when the partition size is not enough for the Intel® Rapid Start Technology to work.

Configuration options: [Enabled] [Disabled]

#### Active Memory Threshold [0]

This item supports Intel Rapid Storage Technology when the partition size is greater than the Active Page Threshold size. When set to zero (0), it will go to Auto mode and checks if the partition size is enough at S3 entry.



---

Ensure that the caching partition size is larger than the total memory size.

---



### Hybrid Hard Disk Support [Disabled]

This item allows you to enable or disable the hybrid hard disk support for a faster resume time.

Configuration options: [Enabled] [Disabled]

### Intel Smart Connect Technology Support [Disabled]

This item allows the system to support Intel Smart Connect Technology, that periodically refreshes selected applications when the system is in sleep mode.

Configuration options: [Enabled] [Disabled]

## 3.6.3 PCH Storage Configuration

While entering Setup, the BIOS automatically detects the presence of SATA devices. The SATA Port items show **Not Present** if no SATA device is installed to the corresponding SATA port.

Scroll down to display the other BIOS items.

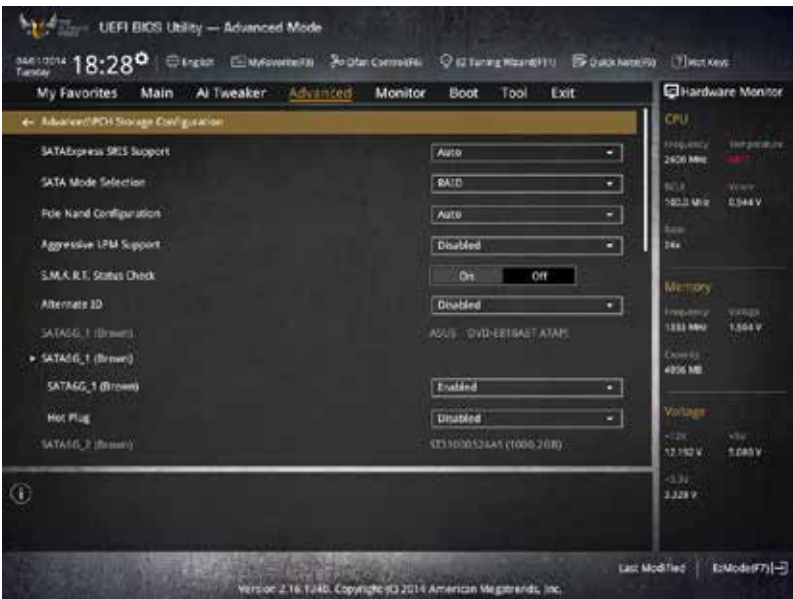

### SATA Mode Selection [AHCI]

This item allows you to set the SATA configuration.

- [Disabled] Disables the SATA function.
- [IDE] Set to [IDE] when you want to use the Serial ATA hard disk drives as Parallel ATA physical storage devices.
- [AHCI] Set to [AHCI] when you want the SATA hard disk drives to use the AHCI (Advanced Host Controller Interface). The AHCI allows the onboard storage driver to enable advanced Serial ATA features that increases storage performance on random workloads by allowing the drive to internally optimize the order of commands.
- [RAID] Set to [RAID] when you want to create a RAID configuration from the SATA hard disk drives.

### Aggressive LPM Support [Disabled]

This item is designed for LPM (link power management) support with a better energy saving conditions. When disabled, the hot plug function of SATA ports are disabled.

Configuration options: [Disabled] [Enabled]

### S.M.A.R.T. Status Check [On]

S.M.A.R.T. (Self-Monitoring, Analysis and Reporting Technology) is a monitoring system that shows a warning message during POST (Power-on Self Test) when an error occurs in the hard disks.

Configuration options: [On] [Off]

### SATA6G\_1 (Brown) ~ SATA6G\_6 (Brown) [Enabled]

These items allow you to enable/disable SATA port.

Configuration options: [Disabled] [Enabled]

### Hot Plug [Disabled]

These items allow you to enable/disable SATA Hot Plug Support.

Configuration options: [Disabled] [Enabled]



---

The following item appears only when you set the SATA Mode Selection to **[RAID]**.

---

### Alternate ID [Disabled]

This item allows you to report the alternate Device ID.

Configuration options: [Disabled] [Enabled]

## 3.6.4 System Agent Configuration

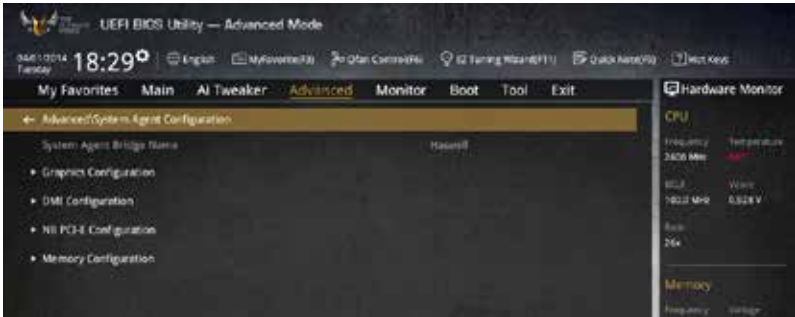

### Graphics Configuration

This item allows you to select a primary display from CPU and PCIe graphical devices.

#### Primary Display [Auto]

This item allows you to select the primary display from CPU and PCIe devices.  
Configuration options: [Auto] [CPU Graphics] [PCIE]

#### CPU Graphics Multi-Monitor [Disabled]

This item allows you to enable the iGPU Multi-Monitor. The iGPU shared system memory size is fixed 64 MB.

Configuration options: [Disabled] [Enabled]

### DMI Configuration

This item allows you to control various DMI (direct media interface) to run at PCI-E 2.0 speed.

#### DMI Gen 2 [Enabled]

Set this item to [Enabled] to run DMI at PCI-E 2.0 speed.

Configuration options: [Enabled] [Disabled]

### NB PCI-E Configuration

This item allows you to configure the NB PCI Express settings.

#### PCIEx16\_1/2 Link Speed [Auto]

This item allows you to configure the PCIEx16 speed for slots 1 and 2.

Configuration options: [Auto] [Gen1] [Gen2] [Gen3]

### Memory Configuration

This item allows you to configure the memory configuration parameters.

#### Memory Scrambler [Enabled]

Set this item to [Enabled] to support high frequency DRAMs for a better stability.

Configuration options: [Enabled] [Disabled]

#### Memory Remap [Enabled]

Set this item to [Enabled] to support DRAM address remapping for 64-bit operating systems.

Configuration options: [Enabled] [Disabled]

### 3.6.5 USB Configuration

The items in this menu allow you to change the USB-related features.

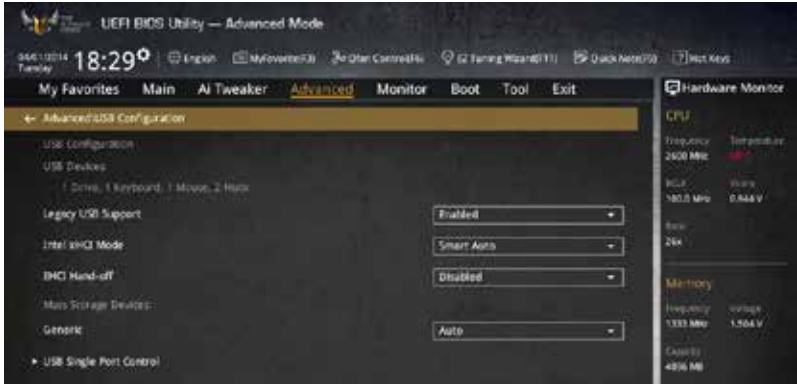

The **Mass Storage Devices** item shows the auto-detected values. If no USB device is detected, the item shows **None**.

#### Legacy USB Support [Enabled]

- [Enabled] Your system supports the USB devices in legacy operating systems.
- [Disabled] Your USB devices can be used for BIOS setup only and cannot be recognized in the boot devices list.
- [Auto] Your system automatically detects the presence of USB devices at startup. If any USB devices are detected, the legacy USB support is enabled.

#### Intel xHCI Mode [Smart Auto]

- [Auto] The xHCI is automatically enabled and runs at USB 3.0 mode when the xHCI driver is installed in the operating system.
- [Smart Auto] Upon detection, the xHCI driver supports the USB 3.0 mode during both POST and operating system.
- [Enabled] Enables the xHCI controller.
- [Disabled] Disables the xHCI controller.

#### EHCI Hand-off [Disabled]

- [Enabled] Enables the support for operating systems without an EHCI hand-off feature.
- [Disabled] Disables the EHCI Hand-off support.

## Mass Storage Devices

### Generic [Auto]

This item allows your system to detect the devices according to their media formats.

Configuration options: [Auto] [Floppy] [Forced FDD] [Hard Disk] [CD-ROM]

### USB Single Port Control

This item allows you to enable or disable the individual USB ports.



Refer to the **Motherboard layout** section for the location of the USB ports.

## 3.6.6 Platform Misc Configuration

The items in this menu allow you to configure the platform-related features.



### PCI-E Native Power Management [Disabled]

This item allows you to enhance the power saving feature of PCI Express and perform ASPM operations in the operating system.

Configuration options: [Disabled] [Enabled]



The following item appears only when you set the PCI-E Native Power Management to **[Enabled]**.

#### Native ASPM [Disabled]

[Enabled] Windows® Vista OS controls the ASPM (active state power management) support for devices.

[Disabled] BIOS controls the ASPM support for the device.

## **PCH - PCI Express options**

### **DMI Link ASPM Control [Disabled]**

This item allows you to control the Active State Power Management on both NB (NorthBridge) side and SB (SouthBridge) side of the DMI Link.

Configuration options: [Disabled] [Enabled]

### **ASPM Support [Disabled]**

This item allows you to select the ASPM state for energy-saving conditions.

Configuration options: [Disabled] [L0s] [L1] [L0sL1] [Auto]

## **SA - PCI Express options**

### **DMI Link ASPM Control [Disabled]**

This item allows you to control the Active State Power Management on both CPU and PCH (platform controller hub) Both DMI link ASPM control items of the CPU and PCH sides must be enabled for the ASPM to take effect.

Configuration options: [Disabled] [L0s] [L1] [L0sL1]

### **PEG ASPM Support [Disabled]**

This item allows you to select the ASPM state for energy-saving conditions, or use the ASUS optimized energy saving profile.

Configuration options: [Disabled] [L0s] [L1] [L0sL1] [Auto]

## 3.6.7 Onboard Devices Configuration

Scroll down to view the other BIOS items.



### HD Audio Controller [Enabled]

This item allows you to use the Azalia High Definition Audio Controller

Configuration options: [Disabled] [Enabled]



The following items appear only when you set the HD Audio Controller to **[Enabled]**.

#### Front Panel Type [HD Audio]

This item allows you to set the front panel audio connector (AAFP) mode to legacy AC'97 or high-definition audio depending on the audio standard that the front panel audio module supports.

[HD Audio] Sets the front panel audio connector (AAFP) mode to high definition audio.

[AC97] Sets the front panel audio connector (AAFP) mode to legacy AC'97

#### SPDIF Out Type [SPDIF]

[SPDIF] Sets to an SPDIF audio output.

[HDMI] Sets to an HDMI audio output.

### Intel LAN Controller [Enabled]

This item allows you to enable or disable the Intel® LAN controller.  
Configuration options: [Disabled] [Enabled]



The following item appears only when you set the Intel LAN Controller to **[Enabled]**.

### Intel PXE OPRM [Disabled]

This item allows you to enable or disable the Intel® LAN PXE (Preboot Execution Environment) option ROM.  
Configuration options: [Enabled] [Disabled]

## 3.6.8 APM Configuration

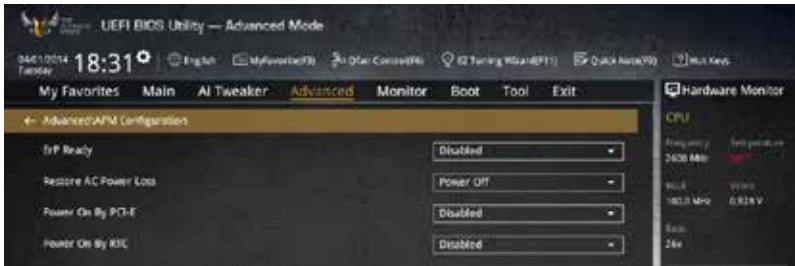

### ErP Ready [Disabled]

This item allows you to switch off some power at S4+S5 or S5 to get the system ready for ErP requirement. When set to **[Enabled]**, all other PME options are switched off.  
Configuration options: [Disabled] [Enabled (S4+S5)] [Enabled (S5)]

### Restore AC Power Loss [Power Off]

This item allows your system to go to ON state, OFF state, or both states after an AC power loss. When setting your system to [Last State], it goes to the previous state before the AC power loss.

Configuration options: [Power Off] [Power On] [Last State]

### Power On By PCI-E [Disabled]

This item allows you to enable or disable the Wake-on-LAN function of the onboard LAN controller or other installed PCI-E LAN cards.

Configuration options: [Disabled] [Enabled]

### Power On By RTC [Disabled]

This item allows you to enable or disable the RTC (Real-Time Clock) to generate a wake event and configure the RTC alarm date. When enabled, you can set the days, hours, minutes, or seconds to schedule an RTC alarm date.

Configuration options: [Disabled] [Enabled]



### 3.6.9 Network Stack Configuration

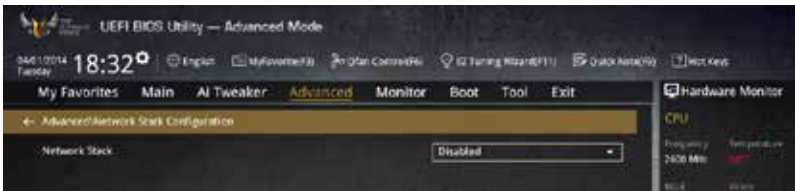

#### Network stack [Disabled]

This item allows you to disable or enable the UEFI network stack.

Configuration options: [Disabled] [Enabled]



---

The following item appears only when you set the Network Stack to **[Enabled]**.

---

#### Ipv4/Ipv6 PXE Support [Enabled]

This item allows you to enable or disable the Ipv4/Ipv6 PXE wake event.

Configuration options: [Disabled] [Enabled]

### 3.7 Monitor menu

The Monitor menu displays the system temperature/power status, and allows you to change the fan settings.

Scroll down to display the other BIOS items.



#### Qfan Tuning

Click this item to automatically detect the lowest speed and configure the minimum duty cycle for each fan.

#### CPU Temperature / MB Temperature [xxx°C/xxx°F]

The onboard hardware monitor automatically detects and displays the CPU and motherboard temperatures.

#### Thermal Radar Temperature

Click this item to set or select the temperature readings that includes VCORE, VCORE(BACK), DRAM, PCH CORE, PCIE-1, PCIE-2, T\_Sensor1 ~ T\_Sensor3 Temperature. Select [Ignore] if you do not wish to display the temperature of an item.

#### CPU Fan Speed [xxxx RPM] or [Ignore] / [N/A], CPU Optional Fan Speed [xxxx RPM] or [Ignore] / [N/A], Chassis Fan 1/4 Speed [xxxx RPM] or [Ignore] / [N/A], ASST Fan 1 Speed [xxxx RPM] or [Ignore] / [N/A]

The onboard hardware monitor automatically detects and displays the CPU, chassis, power, and assistant fan speed in rotations per minute (RPM). If the fan is not connected to the motherboard, the field shows N/A. Select [Ignore] if you do not wish to display the detected speed.

#### CPU Core 0/1 Voltage, 3.3V Voltage, 5V Voltage, 12V Voltage

The onboard hardware monitor automatically detects the voltage output through the onboard voltage regulators. Select [Ignore] if you do not want to detect this item.

## CPU Q-Fan Control [Auto]

This item allows you to set the CPU Q-Fan operating mode.

- [Auto] Detects the type of CPU fan installed and automatically switches the control modes.
- [PWM Mode] Enables the CPU Q-Fan control feature in PWM mode for 4-pin CPU fan.
- [DC Mode] Enables the CPU Q-Fan control feature in DC mode for 3-pin CPU fan.
- [Disabled] Disables the Q-Fan control.



---

The following items appear only when you set the CPU Q-Fan Control to **[Auto]**, **[PWM Mode]**, and **[DC Mode]**.

---

## CPU Fan Speed Low Limit [300 RPM]

This item allows you to set the low limit warning for CPU Fan speed.

Configuration options: [Ignore] [200 RPM] [300 RPM] [400 RPM] [500 RPM] [600 RPM]

## CPU Fan Profile [Standard]

This item allows you to set the appropriate performance level of the CPU fan.

- [Standard] Set to make the CPU fan adjust automatically depending on the CPU temperature.
- [Silent] Set to minimize the fan speed for quiet CPU fan operation.
- [Turbo] Set to achieve maximum CPU fan speed.
- [Manual] Set to assign the detailed fan speed control parameters.



---

The following items appear only when you set the CPU Fan Profile to **[Manual]**.

---

### ***CPU Upper Temperature [70]***

Use the <+> or <-> keys to adjust the upper limit of the CPU temperature. The values range from 20°C to 75°C.

### ***CPU Fan Max. Duty Cycle(%) [100]***

Use the <+> or <-> keys to adjust the maximum CPU fan duty cycle. The values may differ via Qfan tuning.

### ***CPU Middle Temperature [25]***

Use the <+> or <-> keys to set the value for CPU Middle Temperature. The range of the values depends on the CPU installed.

### ***CPU Fan Middle Duty Cycle(%) [20]***

Use the <+> or <-> keys to adjust the CPU fan middle duty cycle. The values may differ via Qfan tuning.

### ***CPU Lower Temperature [20]***

Use the <+> or <-> keys to adjust the CPU fan's lower temperature. The values range from 20% to 75%.

### ***CPU Fan Min. Duty Cycle(%) [20]***

Use the <+> or <-> keys to adjust the minimum CPU fan duty cycle. The values may differ via Qfan tuning.

## Chassis Fan 1/4 Q-Fan Control [Enabled]

These items allow you to set the chassis fans' Q-Fan control feature into DC Mode, PWM Mode, or disable these Q-Fan controls from your motherboard.

Configuration options: [Disabled] [DC Mode] [PWM Mode]



---

The following items appear only when you set the Chassis Fan 1/4 Q-Fan Control to **[PWM Mode]** or **[DC Mode]**.

---

### Chassis Fan 1/4 Q-Fan Source [DC Mode]

This item controls the assigned fan according to the selected temperature source.

Configuration options: [CPU] [MB] [VRM] [PCH Core] [T\_SENSOR1]



---

If you select T\_SENSOR1, plug a thermistor cable to T\_SENSOR1 header and stick the thermistor cable's head to the desired component as the temperature source.

---

### Chassis Fan 1/4 Speed Low Limit 1/4 [300 RPM]

This item allows you to disable or set the chassis fan warning speed.

Configuration options: [Ignore] [200 RPM] [300 RPM] [400 RPM] [500 RPM] [600 RPM]

### Chassis Fan 1/4 Profile [Standard]

This item allows you to set the appropriate performance level of the chassis fan.

[Standard] Set to make the chassis fan adjust automatically depending on the chassis temperature.

[Silent] Set to minimize the fan speed for quiet chassis fan operation.

[Turbo] Set to achieve maximum chassis fan speed.

[Manual] Set to assign detailed fan speed control parameters.



---

The following items appear only when you set the Chassis Fan Profile to **[Manual]**.

---

#### **Chassis Fan 1/4 Upper Temperature [70]**

Use the <+> or <-> keys to adjust the upper limit of the CPU temperature. The values range from 40°C to 90°C.

#### **Chassis Fan 1/4 Max. Duty Cycle(%) [100]**

Use the <+> or <-> keys to adjust the maximum chassis fan duty cycle. The values may differ via Qfan tuning.

#### **Chassis Fan 1/4 Middle Temperature [45]**

Use the <+> or <-> keys to set the value for Chassis Fan Middle Temperature.

#### **Chassis Fan 1/4 Middle Duty Cycle(%) [60]**

Use the <+> or <-> keys to adjust the chassis fan middle duty cycle. The values may differ via Qfan tuning.

#### **Chassis Fan 1/4 Lower Temperature [40]**

Use the <+> or <-> keys to adjust the chassis fans' lower temperature. The values may differ via Qfan tuning.

#### **Chassis Fan 1/4 Min. Duty Cycle(%) [60]**

Use the <+> or <-> keys to adjust the minimum chassis fan duty cycle. The values may differ via Qfan tuning.

### ***Allow Fan Stop 1/4 [Disabled]***

These items allow the chassis fans to run at 0% duty cycle when the temperature of the source is dropped below the lower temperature.

Configuration options: [Disabled] [Enabled]

### **ASST 1 Fan Q-Fan Control [Enabled]**

These items allow you to set the assistant fans' Q-Fan control feature into DC Mode or disable these Q-Fan controls from your motherboard.

Configuration options: [Disabled] [Enabled]



The following items appear only when you set the Assistant Fan Q-Fan Control to **[Enabled]**.

### **ASST 1 Fan Q-Fan Source [CPU]**

This item controls the assigned fan according to the selected temperature source.

Configuration options: [CPU] [MB] [VCORE] [VCORE (BACK)] [DRAM] [PCH Core] [USB3.0] [PCI-E-1] [PCI-E-2] [T\_Sensor1] [T\_Sensor2] [T\_Sensor3]



If you select T\_SENSOR 1/3, plug a thermistor cable to T\_SENSOR 1/3 headers and stick the thermistor cable's head to the desired component as the temperature source.

### **ASST 1 Fan Speed Low Limit [300 RPM]**

This item allows you to disable or set the assistant fans' warning speed.

Configuration options: [Ignore] [200 RPM] [300 RPM] [400 RPM] [500 RPM] [600 RPM]

### **ASST 1 Fan Profile [Standard]**

This item allows you to set the appropriate performance level of the assistant fans.

[Standard] Set to make the assistant fan adjust automatically depending on the chassis temperature.

[Silent] Set to minimize the fan speed for quiet assistant fan operation.

[Turbo] Set to achieve maximum assistant fan speed.

[Manual] Set to assign detailed fan speed control parameters.



The following items appear only when you set the ASST 1 FanProfile to **[Manual]**.

### ***ASST 1 Fan Upper Temperature [70]***

Use the <+> or <-> keys to adjust the upper limit of the CPU temperature. The values range from 40°C to 90°C.

### ***ASST 1 Fan Max. Duty Cycle(%) [100]***

Use the <+> or <-> keys to adjust the maximum assistant fan duty cycle. The values may differ via Qfan tuning.

### ***ASST 1 Fan Lower Temperature [40]***

Use the <+> or <-> keys to adjust the assistant fans' lower temperature. The values may differ via Qfan tuning.

### **ASST 1 Fan Min. Duty Cycle(%) [60]**

Use the <+> or <-> keys to adjust the minimum assistant fan duty cycle. The values may differ via Qfan tuning.

### **Allow Fan Stop [Disabled]**

These items allow the assistant fans to run at 0% duty cycle when the temperature of the source is dropped below the lower temperature.

Configuration options: [Disabled] [Enabled]

## **ASST 2 Fan Q-Fan Source [CPU]**

This item controls the assigned fan according to the selected temperature source.

Configuration options: [CPU] [MB] [VCORE] [VCORE(BACK)] [DRAM] [PCH Core] [PCI-E-1] [PCI-E-2] [T\_Sensor1] [T\_Sensor2] [T\_Sensor3]



---

If you select T\_SENSOR 1/3, plug a thermistor cable to T\_SENSOR 1/3 headers and stick the thermistor cable's head to the desired component as the temperature source.

---

## **ASST 2 Fan Speed Low Limit [300 RPM]**

This item allows you to disable or set the assistant fans' warning speed.

Configuration options: [Ignore] [200 RPM] [300 RPM] [400 RPM] [500 RPM] [600 RPM]

## **ASST 2 Fan Profile [Standard]**

This item allows you to set the appropriate performance level of the assistant fans.

- |            |  |
|------------|--|
| [Standard] | Set to make the assistant fan adjust automatically depending on the chassis temperature. |
| [Silent]   | Set to minimize the fan speed for quiet assistant fan operation.                         |
| [Turbo]    | Set to achieve maximum assistant fan speed.  |
| [Manual]   | Set to assign detailed fan speed control parameters.                                     |



---

The following items appear only when you set the ASST 2 FanProfile to [Manual].

---

### **ASST 2 Fan Upper Temperature [70]**

Use the <+> or <-> keys to adjust the upper limit of the CPU temperature. The values range from 40°C to 90°C.

### **ASST 2 Fan Max. Duty Cycle(%) [100]**

Use the <+> or <-> keys to adjust the maximum assistant fan duty cycle. The values may differ via Qfan tuning.

### **ASST 2 Fan Lower Temperature [40]**

Use the <+> or <-> keys to adjust the assistant fans' lower temperature. The values may differ via Qfan tuning.

### **ASST 2 Fan Min. Duty Cycle(%) [60]**

Use the <+> or <-> keys to adjust the minimum assistant fan duty cycle. The values may differ via Qfan tuning.

### **Allow Fan Stop [Disabled]**

These items allow the assistant fans to run at 0% duty cycle when the temperature of the source is dropped below the lower temperature.

Configuration options: [Disabled] [Enabled]

**Fan Overtime [1 minutes]**

This item allows you to set a time (in minutes) of the assistant fans' operation prior to system shutdown. These assistant fans dissipate any remaining heat and extend the critical component's longevity, dissipating heat as much as 7°C in just 10 minutes.

Configuration options: [Disabled] [1 minute] [3 minutes] [5 minutes] [10 minutes]

**Anti Surge Support [Enabled]**

This item allows you to enable or disable the OVP (Over Voltage Protection) and UVP (Under Voltage Protection) functions. This causes the system to automatically shut down when the voltage exceeds the safe range that protects the motherboard's components.

Configuration options: [Disabled] [Enabled]

## 3.8 Boot menu

The Boot menu items allow you to change the system boot options.



### Boot Configuration

#### Fast Boot [Enabled]

[Disabled] This item allows your system to go back to its normal boot speed.

[Enabled] This item allows your system to accelerate the boot speed.



The following items appear only when you set the Fast Boot to **[Enabled]**.

#### SATA Support [All Devices]

[All Devices] All devices connected to SATA ports are available during POST. This process extends the POST time,

[Hard Drive Only] Only hard drives connected to SATA ports are detected during POST.

[Boot Drive Only] Only boot drives connected to a SATA ports are detected during POST.

#### USB Support [Partial Initialization]

[Disabled] All USB devices will not be available until OS boot up for a fastest POST time.

[Full Initialization] All USB devices will be available during POST. This process will extend the POST time.

[Partial Initialization] For a faster POST time, only USB ports with keyboard and mouse connections will be detected.



### Network Stack Driver Support [Disabled]

[Disabled] Select to skip the network stack driver from loading during POST.

[Enabled] Select to load the network stack driver during POST.

### Next Boot after AC Power Loss [Normal Boot]

[Normal Boot] Returns to normal boot on the next boot after an AC power loss.

[Fast Boot] Accelerates the boot speed on the next boot after an AC power loss.

### DirectKey (DRCT) [Enabled]

[Disabled] Disables the DirectKey button. The system will only power on or off when you press the DirectKey button.

[Enabled] Allows the system to power on and go to the BIOS Setup directly when you press the Reset button. Connect the 2-pin connector of the chassis reset button cable to the onboard DRCT header.

### Boot Logo Display [Auto]

[Auto] Sets the boot logo to display during POST.

[Full Screen] Sets the boot logo display in full screen during POST.

[Disabled] Disables the boot logo display during POST.



---

The following item appears only when you set the Boot Logo Display to **[Auto]** and **[Full Screen]**.

---

### Post Delay Time [3 sec]

This item allows you to select a desired additional POST waiting time to easily enter the BIOS Setup. You can only execute the POST delay time during normal boot. The values range from 0 to 10 seconds.



---

This feature only works when set under normal boot.

---



---

The following items appear only when you set the Boot Logo Display to **[Disabled]**.

---

### Post Report [5 sec]

This item allows you to select a desired POST report waiting time.

Configuration options: [1 sec] - [10 sec] [Until Press ESC]

### Boot up NumLock State [Enabled]

This item allows you to enable or disable power-on state of the NumLock.

Configuration options: [Disabled] [Enabled]

### Wait For 'F1' If Error [Enabled]

This item allows your system to wait for the <F1> key to be pressed when error occurs.

Configuration options: [Disabled] [Enabled]

### Option ROM Messages [Enabled]

- [Enabled] The third-party ROM messages will be displayed during POST.
- [Disabled] Disables the ROM messages and displays only the ASUS logo during POST.

### Interrupt 19 Capture [Disabled]

This item allows you to trap Interrupt 19 by the option ROMs.

Configuration options: [Disabled] [Enabled]

### Above 4G Decoding [Disabled]

This item allows you to decode the 64-bit capable devices above 4G address space. Ensure that your system supports 64-bit PCI decoding.

Configuration options: [Disabled] [Enabled]

### Setup Mode [EZ Mode]

- [Advanced Mode] This item allows you to go to Advanced Mode of the BIOS after POST.
- [EZ Mode] This item allows you to go to EZ Mode of the BIOS after POST.

### CSM (Compatibility Support Module)

This item allows you to configure the CSM (Compatibility Support Module) items to fully support the various VGA, bootable devices and add-on devices for better compatibility.

#### Launch CSM [Enabled]

- [Auto] The system automatically detects the bootable devices and the add-on devices.
- [Enabled] For better compatibility, enable the CSM to fully support the non-UEFI driver add-on devices or the Windows® UEFI mode.
- [Disabled] Disables the CSM to fully support the non-UEFI driver add-on devices or the Windows® UEFI mode.



---

The following items appear only when you set the Launch CSM to **[Enabled]**.

---

#### ***Boot Devices Control [UEFI and Legacy OpROM]***

This item allows you to select the type of devices that you want to boot.

Configuration options: [UEFI and Legacy OpROM] [Legacy OpROM only] [UEFI only]

#### ***Boot from Network Devices [Legacy OpROM first]***

This item allows you to select the type of network devices that you want to launch.

Configuration options: [Legacy OpROM first] [UEFI driver first] [Ignore]

#### ***Boot from Storage Devices [Legacy OpROM first]***

This item allows you to select the type of storage devices that you want to launch.

Configuration options: [Both, Legacy OpROM first] [Both, UEFI first] [Legacy OpROM first] [UEFI driver first] [Ignore]

#### ***Boot from PCI-E/PCI Expansion Devices [Legacy OpROM first]***

This item allows you to select the type of PCIe/PCI expansion devices that you want to launch.

Configuration options: [Legacy OpROM first] [UEFI driver first]

## Secure Boot

This item allows you to configure the Windows® Secure Boot settings and manage its keys to protect the system from unauthorized access and malwares during POST.

### OS Type [Windows UEFI Mode]

- |                     |  |
|---------------------|--|
| [Windows UEFI Mode] | This item allows you to select your installed operating system. Execute the Microsoft® Secure Boot check. Only select this option when booting on Windows® UEFI mode or other Microsoft® Secure Boot compliant OS. |
| [Other OS]          | Get the optimized function when booting on Windows® non-UEFI mode. Microsoft® Secure Boot only supports Windows® UEFI mode.  |



---

The following item appears only when you set the OS Type to **[Windows UEFI mode]**.

---

### Key Management

This allows you to manage the Secure Boot keys.

#### ***Install Default Secure Boot keys***

This item allows you to immediately load the default Security Boot keys, Platform key (PK), Key-exchange Key (KEK), Signature database (db), and Revoked Signatures (dbx). When the default Secure boot keys are loaded, the PK state will change from Unloaded mode to loaded mode.

#### ***Clear Secure Boot keys***

This item appears only when you load the default Secure Boot keys. This item allows you to clear all default Secure Boot keys.

#### ***Save Secure Boot Keys***

This item allows you to save the PK (Platform Keys) to a USB storage device.

### PK Management

The Platform Key (PK) locks and secures the firmware from any permissible changes. The system verifies the PK before your system enters the OS.

#### ***Delete PK***

This item allows you to delete the PK from your system. Once the PK is deleted, all the system's Secure Boot keys will not be active.

Configuration options: [Yes] [No]

### **Load Default PK**

This item allows you to load the downloaded PK from a USB storage device.



---

The PK file must be formatted as a UEFI variable structure with time-based authenticated variable.

---

## **KEK Management**

The KEK (Key-exchange Key or Key Enrollment Key) manages the Signature database (db) and Revoked Signature database (dbx).



---

Key-exchange Key (KEK) refers to Microsoft® Secure Boot Key-Enrollment Key (KEK).

---

### **Delete KEK**

This item allows you to delete the KEK from your system.

Configuration options: [Yes] [No]

### **Load Default KEK**

This item allows you to load the downloaded KEK from a USB storage device.

### **Append Default KEK**

This item allows you to load the additional KEK from a storage device for an additional db and dbx loaded management.



---

The KEK file must be formatted as a UEFI variable structure with time-based authenticated variable.

---

## **DB Management**

The db (Authorized Signature database) lists the signers or images of UEFI applications, operating system loaders, and UEFI drivers that you can load on the single computer.

### **Delete the db**

This item allows you to delete the db file from your system.

Configuration options: [Yes] [No]

### **Load Default db**

This item allows you to load the downloaded db from a USB storage device.

### **Append Default db**

This item allows you to load the additional db from a storage device so that more images can be loaded securely.



---

The db file must be formatted as a UEFI variable structure with time-based authenticated variable.

---

## DBX Management

The dbx (Revoked Signature database) lists the forbidden images of db items that are no longer trusted and cannot be loaded.

### **Delete the dbx**

This item allows you to delete the dbx file from your system.

### **Load Default dbx**

This item allows you to load the downloaded dbx from a USB storage device.

Configuration options: [Yes] [No]

### **Append Default**

This item allows you to load the additional dbx from a storage device so that more db's images cannot be loaded.



---

The dbx file must be formatted as a UEFI variable structure with time-based authenticated variable.

---

## Boot Option Priorities

These items specify the boot device priority sequence from the available devices. The number of device items that appears on the screen depends on the number of devices installed in the system.



- To access Windows® OS in Safe Mode, press <F8 > after POST (Windows® 8 not supported).
  - To select the boot device during system startup, press <F8> when ASUS Logo appears.
- 

## Boot Override

These item displays the available devices. The number of device items that appear on the screen depends on the number of devices installed in the system. Click an item to start booting from the selected device.

### 3.9 Tool menu

The Tool menu items allow you to configure options for special functions. Select an item then press <Enter> to display the submenu.

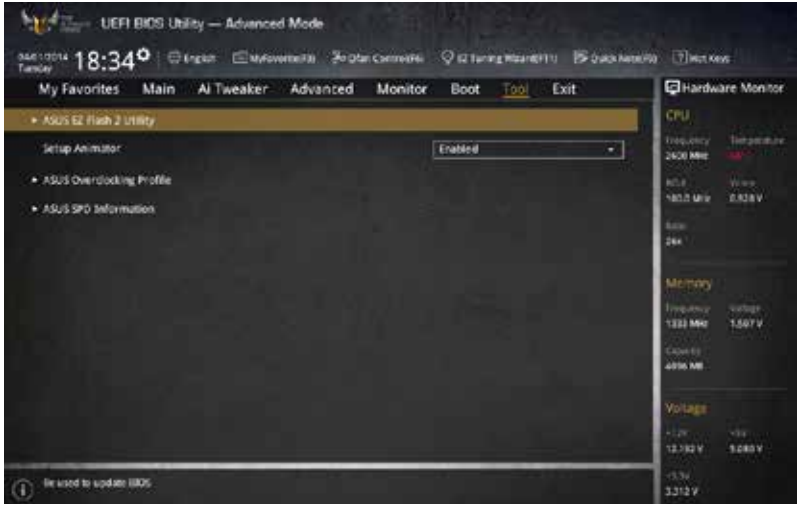

#### Setup Animator [Enabled]

This item allows you to enable or disable the Setup animator.

Configuration options: [Disabled] [Enabled]

#### 3.9.1 ASUS EZ Flash 2 Utility

This item allows you to run ASUS EZ Flash 2. When you press <Enter>, a confirmation message appears. Use the left/right arrow key to select between [Yes] or [No], then press <Enter> to confirm your choice.



For more details, refer to section **ASUS EZ Flash 2**.

## 3.9.2 ASUS Overclocking Profile

This item allows you to store or load multiple BIOS settings.

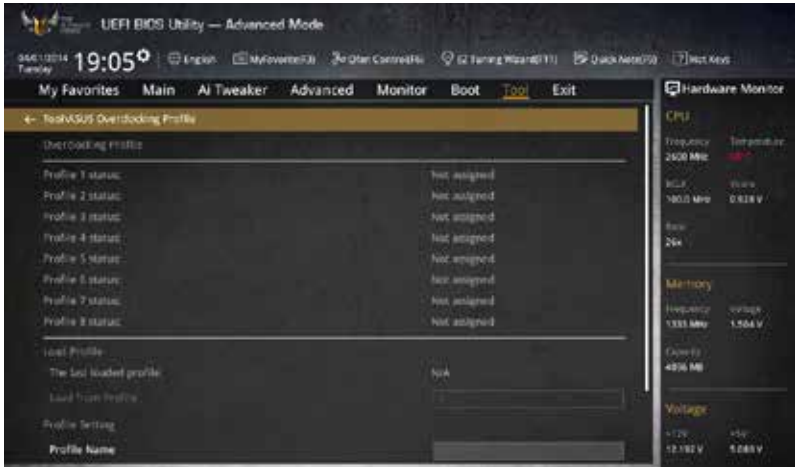

### Load from Profile

This item allows you to load the previous BIOS settings saved in the BIOS Flash. Key in the profile number that saved your BIOS settings, press <Enter>, and then select **Yes**.



- DO NOT shut down or reset the system while updating the BIOS to prevent the system boot failure!
- We recommend that you update the BIOS file only coming from the same memory/CPU configuration and BIOS version.

### Profile Name

This item allows you to key in a profile name.

### Save to Profile

This item allows you to save the current BIOS settings to the BIOS Flash, and create a profile. Key in a profile number from one to eight, press <Enter>, and then select **Yes**.

### Load/Save Profile from/to USB Drive

This item allows you to load or save profile from your USB drive, load and save profile to your USB drive.

### 3.9.3 ASUS SPD Information

Allow you to review the DRAM SPD (serial presence detect) information.





## 3.10 Exit menu

The Exit menu items allow you to load the optimal default values for the BIOS items, and save or discard your changes to the BIOS items.

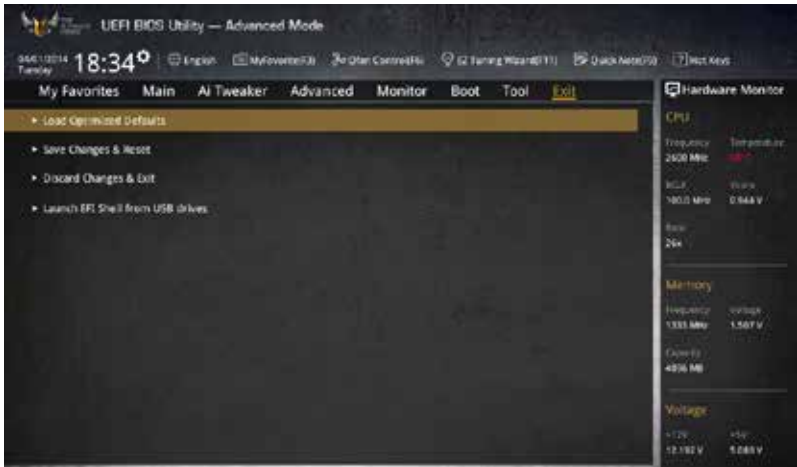

### Load Optimized Defaults

This option allows you to load the default values for each of the parameters on the Setup menus. When you select this option or if you press <F5>, a confirmation window appears. Select **OK** to load the default values.

### Save Changes & Reset

Once you are finished making your selections, choose this option from the Exit menu to ensure the values you selected are saved. When you select this option or if you press <F10>, a confirmation window appears. Select **OK** to save changes and exit.

### Discard Changes & Exit

This option allows you to exit the Setup program without saving your changes. When you select this option or if you press <Esc>, a confirmation window appears. Select **Yes** to discard changes and exit.

### Launch EFI Shell from filesystem device

This option allows you to attempt to launch the EFI Shell application (shellx64.efi) from one of the available filesystem devices.

## 3.11 Updating BIOS

The ASUS website publishes the latest BIOS versions to provide enhancements on system stability, compatibility, and performance. However, BIOS updating is potentially risky. If there is no problem using the current version of BIOS, DO NOT manually update the BIOS. Inappropriate BIOS updating may result to system's failure to boot. Carefully follow the instructions in this chapter to update your BIOS when necessary.



---

Visit <http://www.asus.com> to download the latest BIOS file for this motherboard.

---

The following utilities allow you to manage and update the motherboard BIOS setup program.

1. EZ Update: Updates the BIOS in Windows® environment.
2. ASUS EZ Flash 2: Updates the BIOS using a USB flash drive.
3. ASUS CrashFree BIOS 3: Restores the BIOS using the motherboard support DVD or a USB flash drive when the BIOS file fails or gets corrupted.
4. ASUS BIOS Updater: Updates the BIOS in DOS environment using the motherboard support DVD and a USB flash disk drive.

### 3.11.1 EZ Update

The EZ Update is a utility that allows you to update the motherboard BIOS in Windows® environment.



- EZ Update requires an Internet connection either through a network or an ISP (Internet Service Provider).
  - This utility is available in the support DVD that comes with the motherboard package.
  - Refer to section **EZ Update** of this user guide for more information.
-

### 3.11.2 ASUS EZ Flash 2

ASUS EZ Flash 2 allows you to update the BIOS without having to use a bootable floppy disk or an OS-based utility.



---

Before you start using this utility, download the latest BIOS from the ASUS website at [www.asus.com](http://www.asus.com).

---

#### To update the BIOS using EZ Flash 2:

1. Insert the USB flash disk that contains the latest BIOS file to the USB port.
2. Enter the Advanced Mode of the BIOS setup program. Go to the Tool menu to select ASUS EZ Flash Utility and press <Enter> to enable it.
3. Press <Tab> to switch to the Drive field.
4. Press the Up/Down arrow keys to find the USB flash disk that contains the latest BIOS, and then press <Enter>.
5. Press <Tab> to switch to the Folder Info field.
6. Press the Up/Down arrow keys to find the BIOS file, and then press <Enter> to perform the BIOS update process. Reboot the system when the update process is done.



- 
- This function can support devices such as a USB flash disk with FAT 32/16 format and single partition only.
  - DO NOT shut down or reset the system while updating the BIOS to prevent system boot failure!
- 



---

Ensure to load the BIOS default settings to ensure system compatibility and stability. Select the Load Optimized Defaults item under the Exit menu. See section **Exit Menu** for details.

---

### 3.11.3 ASUS CrashFree BIOS 3

The ASUS CrashFree BIOS 3 utility is an auto recovery tool that allows you to restore the BIOS file when it fails or gets corrupted during the updating process. You can restore a corrupted BIOS file using the motherboard support DVD or a USB flash drive that contains the BIOS file.



---

The BIOS file in the motherboard support DVD may be older than the BIOS file published on the ASUS official website. If you want to use the newer BIOS file, download the file at <http://support.asus.com> and save it to a USB flash drive.

---

#### Recovering the BIOS

##### To recover the BIOS:

1. Turn on the system.
2. Insert the motherboard support DVD to the optical drive, or the USB flash drive containing the BIOS file to the USB port.
3. The utility automatically checks the devices for the BIOS file. When found, the utility reads the BIOS file and enters ASUS EZ Flash 2 automatically.
4. The system requires you to enter BIOS Setup to recover the BIOS setting. To ensure system compatibility and stability, we recommend that you press <F5> to load default BIOS values.



---

DO NOT shut down or reset the system while updating the BIOS! Doing so can cause system boot failure!

---

### 3.11.4 ASUS BIOS Updater

ASUS BIOS Updater allows you to update the BIOS in DOS environment.



The screen captures used in this section are for reference only and may not be exactly the same as actually shown on your computer screen.

#### Before updating BIOS

- Prepare the motherboard support DVD and a USB flash drive.
- Download the latest BIOS file and BIOS Updater from <http://support.asus.com> and save them in your USB flash drive.



NTFS is not supported under DOS environment. Ensure that your USB flash drive is in single partition and in FAT32/16 format.

- Turn off the computer.
- Ensure that your computer has a DVD optical drive.

#### Booting the system in DOS environment

To boot the system in DOS:

1. Insert the USB flash drive with the latest BIOS file and BIOS Updater to the USB port.
2. Boot your computer then press <F8> to launch the select boot device screen.
3. When the select boot device screen appears, insert the Support DVD into the optical drive then select the optical drive as the boot device.

```
Please select boot device:
-----
E1:  ASUS DVD-E818A6T  (4069MB)
     USB DISK 2.0  (3824MB)
UEFI: (FAT)  USB DISK 2.0  (3824MB)
Enter Setup
-----

↑ and ↓ to move selection
ENTER to select boot device
ESC to boot using defaults
```

- When the booting message appears, press <Enter> within five (5) seconds to enter FreeDOS prompt.

```
ISOLINUX 3.20 2006-08-26 Copyright (C) 1994-2005 H. Peter Anvin
A Bootable DVD/CD is detected. Press ENTER to boot from the DVD/CD.
If no key is pressed within 5 seconds, the system will boot next priority
device automatically. boot:
```

- On the FreeDOS prompt, type **d:** then press <Enter> to switch the disk from Drive C (optical drive) to Drive D (USB flash drive).

```
Welcome to FreeDOS (http://www.freedos.org)!
C:>/> d:
D:>/>
```

### Updating the BIOS file

To update the BIOS file:

- On the FreeDOS prompt, type **bupdater /pc /g** and press <Enter>.

```
D:>/> bupdater /pc /g
```

- On the BIOS Updater screen, press <Tab> to switch from Files panel to Drives panel then select **D:**.

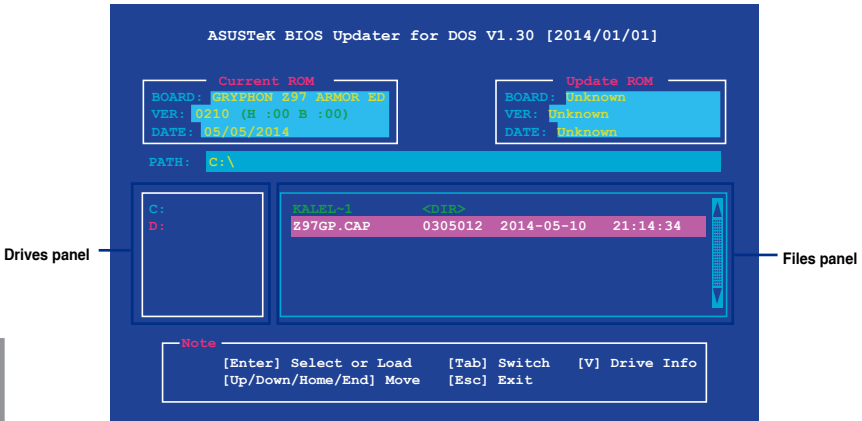

- Press <Tab> to switch from Drives panel to Files panel then press <Up/Down or Home/End> keys to select the BIOS file and press <Enter>.

4. After the BIOS Updater checks the selected BIOS file, select **Yes** to confirm the BIOS update.



---

The BIOS Backup feature is not supported due to security regulations.

---

5. Select **Yes** then press <Enter>. When BIOS update is done, press <ESC> to exit BIOS Updater.
6. Restart your computer.



---

DO NOT shut down or reset the system while updating the BIOS to prevent system boot failure.

---



---

Ensure to load the BIOS default settings to ensure system compatibility and stability. Select **Load Optimized Defaults** item under the **Exit BIOS** menu. See section **Exit menu** for details.

---





# Software support

# 4

## 4.1 Installing an operating system



- This motherboard supports 32-bit/64-bit Windows® 7, 32-bit/64-bit Windows® 8, and 32-bit/64-bit Windows® 8.1 operating systems (OS).
- Motherboard settings and hardware options vary. The setup procedures presented in this chapter are for reference only. Refer to Windows® operating system documentation for detailed information.

## 4.2 Support DVD information



The contents of the support DVD are subject to change at any time without notice. Visit the ASUS website at [www.asus.com](http://www.asus.com) for updates.

### 4.2.1 Running the support DVD



Ensure that you have an Administrator account before running the support DVD in Windows® 7, Windows® 8, or Windows® 8.1 operating systems.

To run the support DVD:

1. Place the Support DVD into the optical drive.
2. In the **AutoPlay** dialog box, click or tap **Run ASSETUP.EXE**.

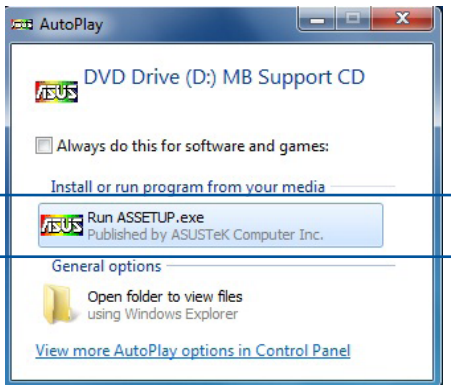

If the **AutoPlay** dialog box does not appear, browse the contents of the support DVD and double-click or tap `\\bin\ASSETUP.EXE` to launch the **ASUS motherboard support DVD** main menu.

# Support DVD main menu

The Drivers menu shows the available device drivers if the system detects installed devices. Install the necessary drivers to use the devices.

The AHCI/RAID Driver menu contains the RAID/AHCI driver disk.

The Manual menu contains the list of supplementary user guides. Click or tap an item to open the folder of the user guide.

The Utilities menu shows the applications and other software that the motherboard supports.

Click or tap an item to install



Click or tap to display the ASUS contact information.

Click or tap an icon to display DVD/motherboard information

## 4.2.2 Obtaining the software manuals

The software manuals are included in the support DVD. Follow the instructions below to get the necessary software manuals.



The software manual files are in Portable Document Format (PDF). Install the Adobe® Acrobat® Reader from the **Utilities** tab before opening the files.

To read about your motherboard's utility guide:

1. Click or tap **Manual** tab > **ASUS Motherboard Utility Guide**.



2. From the **Manual** folder, open the folder of the software manual that you wish to read.

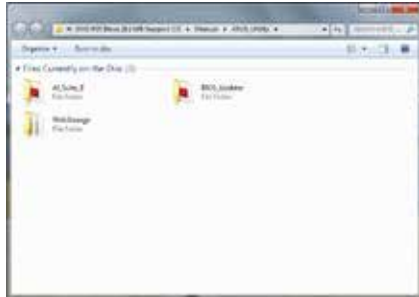

3. Some software manuals are provided in different languages. Open the language's folder to view the software manual.

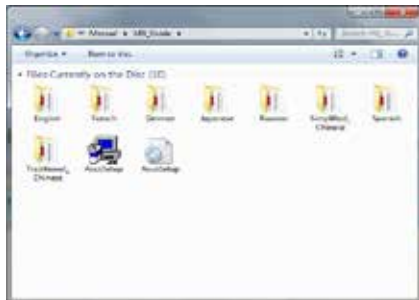

The screenshots in this section are for reference only. The actual software manuals containing in the support DVD vary by models.

## 4.3 Software information

Most of the applications in the support DVD have wizards that will conveniently guide you through the installation. View the online help or readme file that came with the software application for more information.

## 4.4 AI Suite 3

AI Suite 3 is an all-in-one interface that integrates several ASUS utilities and allows you to launch and operate these utilities simultaneously.

### Installing AI Suite 3



---

Ensure that you have an Administrator account before installing AI Suite 3 in Windows® 7, Windows® 8, or Windows® 8.1 operating systems.

---

To install AI Suite 3 on your computer:

#### Windows® 7 OS

1. Place the Support DVD into the optical drive.
2. In the **AutoPlay** dialog box, click or tap **Run ASSETUP.exe** then select the **Utilities** tab.

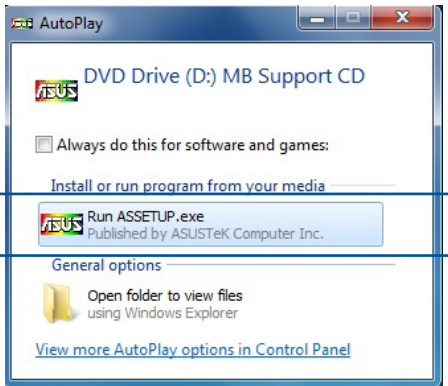

3. From the **Utilities** tab, click or tap **AI Suite 3** then follow the succeeding onscreen instructions.

## Windows® 8 and Windows® 8.1 OS

1. Place the Support DVD into the optical drive then follow onscreen instructions.
2. From the **ASUS motherboard support DVD** main menu, select the Utilities tab and click or tap **AI Suite 3**.
3. Follow the succeeding onscreen instructions.

If the **ASUS motherboard support DVD** main menu did not appear, try the following:

- a. Go to the **Start Screen** then click or tap the **Desktop** app.
- b. On the lower left corner of the Desktop, click or tap **File Explorer**  then select your DVD drive and tap or double-click or tap the **Setup** application.

## Launching AI Suite 3

### Windows® 7 OS

From the Desktop, click or tap **Start > All Programs > ASUS > AI Suite 3 > AI Suite 3**.

You can also launch AI Suite in Windows® 7 by clicking or tapping  on the Notification area.

### Windows® 8 and Windows® 8.1 OS

To launch AI Suite 3 in Windows® 8 or Windows® 8.1, tap the AI Suite 3 app on the Start Screen (or if you're using a mouse, click or tap the AI Suite 3 app on the Start Screen).



## AI Suite 3 Main menu

The AI Suite 3 main menu gives you easy-access controls and insight to what's going on with your computer - allowing you to optimize performance settings while at the same time ensuring system stability.

The AI Suite main menu includes a quick-access menu bar that allows you to swiftly launch any of the integrated ASUS utilities. Click or tap  on the top-right corner of the menu to launch the menu bar.



The AI Suite 3 screenshots in this section are for reference only and can vary depending on motherboard model.

## AI Suite 3 main menu bar

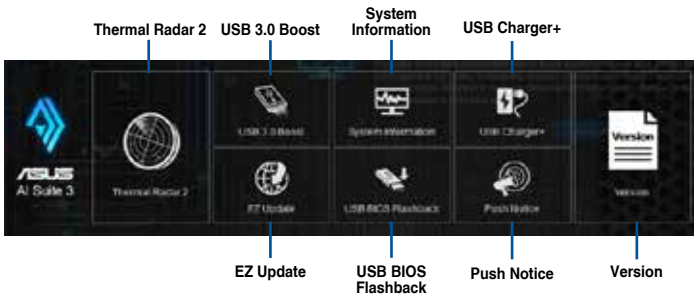

- Some functions in the AI Suite 3 main menu in this user guide may vary depending on the motherboard model.
- Refer to the software manual in the support DVD or visit the ASUS website at [www.asus.com](http://www.asus.com) for detailed software configuration.

## 4.4.1 Thermal Radar 2

Thermal Radar 2 lets you control fans, monitor your graphics card temperature and other key components in real time, or auto-tune your thermal settings.

### Thermal Tuning

This function optimizes your system's cooling solution based on your system's current thermal settings. It allows you to configure your CPU, chassis, and the exclusive TUF Turbo fans to achieve the best balance between cooling performance and low noise.



Click or tap to automatically start the Thermal Tuning process

### Fan Control

Allows you to configure the settings of the fans installed on your system. You can also load or save a fan's profile to tune the thermal condition of your system.

Click or tap to load saved profiles

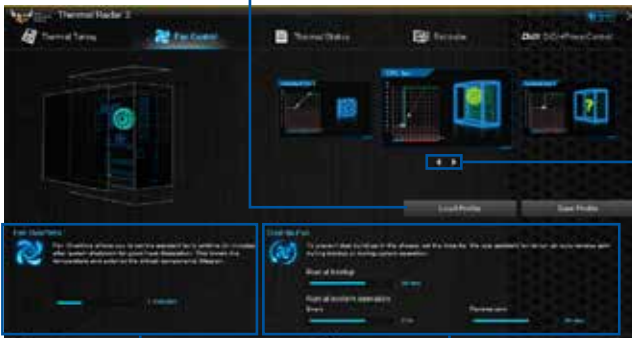

Click or tap to switch between items  
Click or tap to save the settings of the new profile

Fan Overtime settings

Dust de-Fan settings

## VGA

Allows you to configure the thermal settings of an installed ASUS graphics card.



- The VGA tab on Thermal Radar 2 appears only when you install an optional ASUS graphics card into your system.
- The VGA feature of Thermal Radar 2 supports ASUS NVidia 700 Series graphics card only.

### VGA - Auto Mode

The system loads the optimal values for the graphic card's thermal settings.



Press to perform dynamic adjustments on the power and fan speed of the installed graphics card

Click to save a new profile  
Click to load a saved profile

### VGA - Smart Mode

Manually adjust the acceleration and deceleration time of the graphic card's fans.

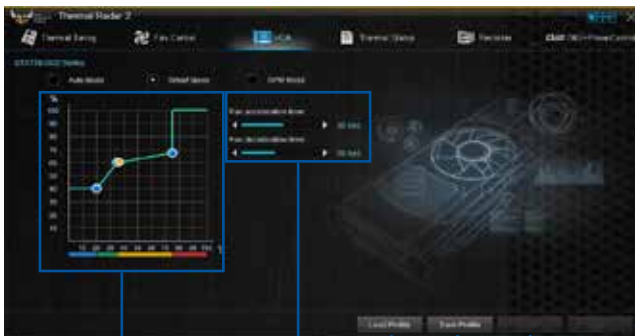

Displays the graph of the thermal settings

Click the sliders to adjust the settings

Click to apply changes  
Click to undo changes  
Click to save a new profile  
Click to load a saved profile



## VGA - RPM Mode

Allows you to manually adjust the fan's speed (in rpm).



Perform Thermal Tuning to enable the RPM Mode. Refer to the **Thermal Tuning** section for more information.



Move the slider up or down to adjust the settings

Click to save a new profile  
Click to load a saved profile

## Thermal Status

Displays the current status of the thermal condition of your system.



Click or tap to run the assessment report of your current thermal settings.

## Recorder

Displays and monitors the status of the thermal setting and condition of your system.



Click or tap to scroll down/up

## DIGI+ Power Control

ASUS DIGI+ Power Control features the revolutionary and innovative digital VRM and DRAM Voltage controllers. These controllers offers ultra-precise memory and voltage tuning for optimal system efficiency, stability and performance.



### DIGI+ Power Control - CPU



### DIGI+ Power Control - DRAM



## 4.4.2 EZ Update

EZ Update is a utility that allows you to automatically update your motherboard's software, drivers and BIOS easily.

With this utility, you can also manually update the BIOS and select the boot logo that displays during POST.

### Launching EZ Update

To launch EZ Update, click or tap  on the top-right corner of the AI Suite 3 main menu, then select **EZ Update**.

### Using EZ Update



## Manually update the BIOS and selecting a boot logo

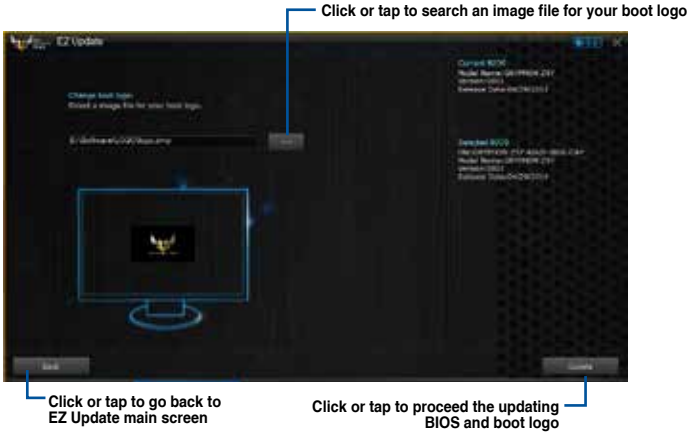

After you click or tap **BIOS Update** button, click or tap **Flash** to update the BIOS and upload the boot logo in your system.



### 4.4.3 USB BIOS Flashback

USB BIOS Flashback allows you to check and save the latest BIOS version to a USB storage device. Use this utility to quickly check for the latest available BIOS and set the BIOS download schedule.

#### Launching USB BIOS Flashback

To launch USB BIOS Flashback, click or tap  on the top-right corner of the AI Suite 3 main menu, then select **USB BIOS Flashback**.



USB BIOS Flashback is available only in selected motherboard models.

#### Using USB BIOS Flashback

Set a schedule for the BIOS Update download



Click or tap to check for a new BIOS update available for download

Click or tap to cancel the download schedule setting

Click or tap to apply the download schedule setting

#### Scheduling the BIOS download

1. In the Download Setting field, tick **Schedule (days)** then select the number of days for the BIOS download schedule.
2. Click or tap **Apply** to save the BIOS download schedule. Click or tap **Cancel** to cancel the download schedule.

## Downloading the latest BIOS





Before you start downloading, ensure that you have installed the USB storage device to your computer's USB port that supports USB BIOS Flashback. Refer to section **2.3.1 Rear I/O connection** of this user guide for more details.

To download the updated BIOS:

1. From the USB BIOS Flashback screen, click or tap **Check for New BIOS Update**.

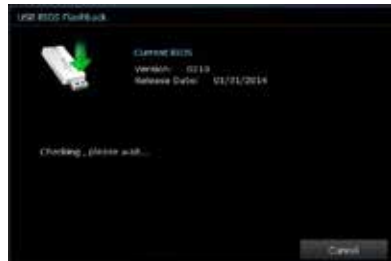
Wait for the system to check the latest BIOS version.



2. After the utility detects a new BIOS, click or tap  from the Save to: field, select the USB flash drive, then click or tap **Download**.



3. After the download is complete, click or tap **OK**.



## 4.4.4 Push Notice

This utility allows you get the detailed status of your system to your smart device. You can also send messages to your smart device using this utility.



Before using this utility, ensure that you pair your computer with your smart device. For pairing information, refer to section **Pairing your computer and smart device**.

### Launching Push Notice on your computer

To launch Push Notice, click or tap  on the top-right corner of the AI Suite 3 main menu, then select **Push Notice**.

### Push Notice screen

Click or tap to enable or disable Push Notice





Click or tap to discard the settings

Click or tap to apply the settings

Tick to select the smart device



You can also enable the Push Notice via the Push Notice shortcut on the lower-right corner of your screen. To do this, click or tap << then click or tap  then select .

### Pairing your computer and smart device

To pair your computer and smart device:

1. On your smart device, tap  to launch Push Notice.
2. Tap **Push Scan** then tap the name of your computer that you want to pair with.



To pair your computer and smart device, ensure that both are connected to the same wireless network.



## Setting up PC Mode alerts of your computer

This feature allows you to restart, shut down, or put your computer to sleep mode and sends an alert to your smart device.



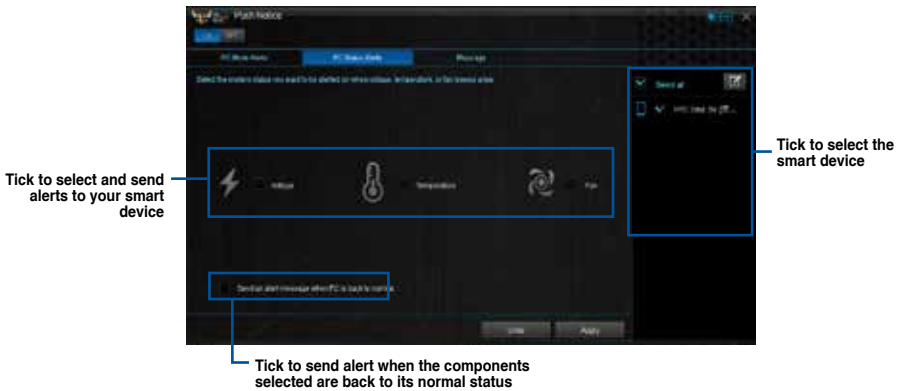

## Setting up PC Status alerts

This feature allows you to send alerts of the unusual activities of the voltage, temperature, and fan settings of your computer to your smart device.



## Sending messages to your smart device

This feature allows you to send messages to your smart device.

You can also send messages via the Push Notice messaging shortcut on the lower-right corner of your screen. To do this, click or tap << then click or tap  then select .

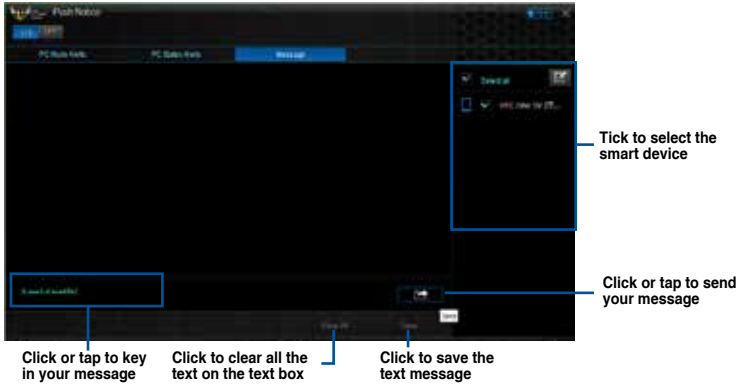

## Viewing your computer status on your smart device

Tap  on your smart device to launch Push Notice.

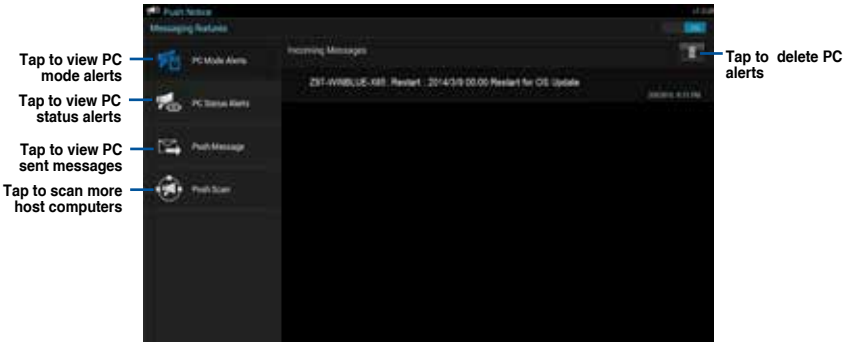

## 4.4.5 USB 3.0 Boost

USB 3.0 Boost technology supports UASP (USB Attached SCSI Protocol) that automatically speeds up the transfer rates of your USB storage devices.

### Launching USB 3.0 Boost

To launch USB 3.0 Boost, click or tap  on the top-right corner of the AI Suite 3 main menu, then select **USB 3.0 Boost**.

### Using the USB 3.0 Boost



Ensure to connect your USB 3.0 device to the USB 3.0 ports that support USB 3.0 Boost. Refer to the **Rear I/O connection** section of your user guide for more details.



- USB 3.0 Boost automatically detects the USB 3.0 devices that support UASP. For a list of UASP-supported USB 3.0 devices, visit the ASUS website at [www.asus.com](http://www.asus.com).
- The data transfer speed varies with USB devices. For a higher data transfer performance, use a USB 3.0 device.

## 4.4.6 System Information

This utility allows you get the detailed information of the motherboard, CPU, and memory settings.

### Launching the System Information

To launch System Information, click or tap  on the top-right corner of the AI Suite 3 main menu, then select **System Information**.

### Viewing the motherboard information

Click or tap the **MB** tab to view the motherboard's information.



### Viewing the CPU information

Click or tap the **CPU** tab to view the processor's information.



## Viewing the SPD information

Click or tap the **SPD** tab to view the memory's information.



## 4.4.7 USB Charger+

USB Charger+ allows you to quick-charge your portable USB devices even if your computer is off, in sleep mode or hibernate mode.



Before using USB Charger+, ensure to disable the ErP Ready item from the **Advanced > APM > ErP Ready** in the Advanced mode of the BIOS Setup program.

### Launching USB Charger+

To launch USB Charger+, click or tap  on the top-right corner of the AI Suite 3 main menu, then select **USB Charger+**.

### USB Charger+ screen



Click or tap to detect the connected USB device

Indicates that the connected USB device is in charging mode

Click or tap to fast-charge your USB device

Click or tap to stop charging your USB device

Click or tap to apply the settings

Click or tap to discard the settings

Click or tap to select the type of USB device that you wish to charge when the system is off



Ensure to connect your USB device into the USB port that supports this utility. Refer to the **Rear I/O connection** section of your user guide for more details.



- The USB Charger+ does not support USB hubs and USB extension cables, and generic USB cables.
- The USB Charger+ may not recognize some ASUS devices due to a special design.

## 4.4.8 Version

Displays the installed software or utilities and their current version.



## 4.5 Turbo LAN

Turbo LAN is a network traffic shaping technology that lowers lag and helps reduce delays during data transfers or when playing online games. It allows you to set programs or application's network priorities to currently running games or applications.

Turbo LAN features an intuitive user interface and an Advance Mode that tweakers can use to configure hardcore controls or settings.

To launch Turbo LAN, click or tap the  on the desktop.

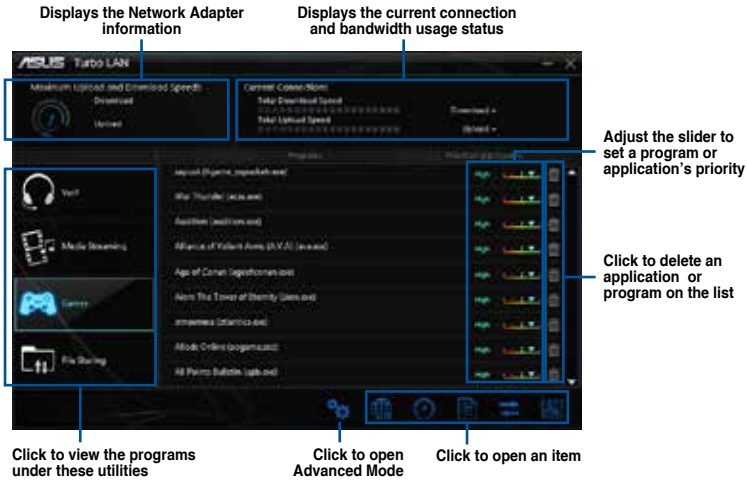

### Using the Advance Mode

The Advance Mode allows you to configure the priorities of your programs or applications or configure your network device.

To go to the Advanced Mode, click or tap .

The Advanced Mode contains the following utilities:

- **Preferences:** Allows you to control the network's traffic to optimize the program's performance, favor ping time, and avoid packet loss.
- **Protocols:** Allows you to set priority to the network adapter and its protocol to reduce delay during data transfer, and maintain the speed of Internet access.
- **Programs:** Allows you to set priority to the programs or applications.
- **Traffic Shaping:** Allows you set the priority to the network adapter and its protocol to reduce delay during data transfer and speeds up the Internet access.
- **Adapter Info:** Displays the information about the installed network adapter in your system.
- **Online Budgets:** Allows you to set an online budget time to your network adapters.
- **Traffic Analysis:** Allows you to assign protocols and programs in one set.



## 4.6 Audio configurations

The Realtek® audio CODEC provides 8-channel audio capability to deliver the ultimate audio experience on your computer. The software provides Jack-Sensing function, S/PDIF Out support, and interrupt capability. The CODEC also includes the Realtek® proprietary UAJ® (Universal Audio Jack) technology for all audio ports, eliminating cable connection errors, and giving users plug and play convenience.

Follow the installation wizard to install the Realtek® Audio Driver from the support DVD that came with the motherboard package.

If the Realtek® audio software is correctly installed, you will find the Realtek® HD Audio Manager icon on the taskbar. Double-click or tap on the icon to display the Realtek® HD Audio Manager.



Realtek® HD Audio Manager

### Realtek® HD Audio Manager



## Selecting an audio output

Realtek HD Audio Manager allows you to select the type of audio output depending on the output device that you are using.

To select an audio output:

1. Insert the audio device's jack to the Line Out (lime) port. If the audio device's jack is already inserted to the corresponding port, click or tap  on the Realtek HD Audio Manager.
2. On the pop-up window, tick the audio device that you plugged to the Line Out port then click or tap **Next**.



- a. If you select **Headphone**, click or tap to select the type of headphone installed then click or tap **OK**.



- b. If you select **Front Speaker Out**, click or tap to select the type of speaker installed then click or tap **OK**.



# RAID support

# 5

## 5.1 RAID configurations

The motherboard comes with the Intel® Rapid Storage Technology that supports RAID 0, RAID 1, RAID 10 and RAID 5 configuration.

### 5.1.1 RAID definitions

**RAID 0 (Data striping)** optimizes two identical hard disk drives to read and write data in parallel, interleaved stacks. Two hard disks perform the same work as a single drive but at a sustained data transfer rate, double that of a single disk alone, thus improving data access and storage. Use of two new identical hard disk drives is required for this setup.

**RAID 1 (Data mirroring)** copies and maintains an identical image of data from one drive to a second drive. If one drive fails, the disk array management software directs all applications to the surviving drive as it contains a complete copy of the data in the other drive. This RAID configuration provides data protection and increases fault tolerance to the entire system. Use two new drives or use an existing drive and a new drive for this setup. The new drive must be of the same size or larger than the existing drive.

**RAID 5** stripes both data and parity information across three or more hard disk drives. Among the advantages of RAID 5 configuration include better HDD performance, fault tolerance, and higher storage capacity. The RAID 5 configuration is best suited for transaction processing, relational database applications, enterprise resource planning, and other business systems. Use a minimum of three identical hard disk drives for this setup.

**RAID 10** is data striping and data mirroring combined without parity (redundancy data) having to be calculated and written. With the RAID 10 configuration you get all the benefits of both RAID 0 and RAID 1 configurations. Use four new hard disk drives or use an existing drive and three new drives for this setup.

## 5.1.2 Installing Serial ATA hard disks

The motherboard supports Serial ATA hard disk drives. For optimal performance, install identical drives of the same model and capacity when creating a disk array.

### To install the SATA hard disks for a RAID configuration:

1. Install the SATA hard disks into the drive bays.
2. Connect the SATA signal cables.
3. Connect a SATA power cable to the power connector on each drive.

## 5.1.3 Setting the RAID item in BIOS

You must enable the RAID function in the BIOS Setup before creating RAID sets using SATA HDDs. To do this:

1. Enter the BIOS Setup during POST.
2. Go to the **Advanced** menu > **SATA Configuration**, and then press <Enter>.
3. Set the SATA Mode item to [RAID Mode].
4. Save your changes, and then exit the BIOS Setup.



---

Refer to Chapter 3 for details on entering and navigating through the BIOS Setup

---



---

Due to chipset limitation, when SATA ports are set to RAID mode, all SATA ports run at RAID mode together.

---

## 5.1.4 Intel® Rapid Storage Technology Option ROM utility

To enter the Intel® Rapid Storage Technology Option ROM utility:

1. Turn on the system.
2. During POST, press <Ctrl> + <I> to display the utility main menu.

```
Intel(R) Rapid Storage Technology - Option ROM - v10.5.1.1070
Copyright(C) 2003-10 Intel Corporation. All Rights Reserved.

[ MAIN MENU ]
1. Create RAID Volume      4. Recovery Volume Options
2. Delete RAID Volume     5. Acceleration Options
3. Reset Disks to Non-RAID 6. Exit

[ DISK/VOLUME INFORMATION ]

RAID Volumes:
None defined.

Physical Devices:
Port Device Model      Serial #      Size  Type/Status (Vol ID)
0  ST3160812AS         9LS0HJA4    149.0GB Non-RAID Disk
1  ST3160812AS         9LS0F4HL    149.0GB Non-RAID Disk
2  ST3160812AS         3LS0JYL8    149.0GB Non-RAID Disk
3  ST3160812AS         9LS0B75H    149.0GB Non-RAID Disk

[↑↓]-Select      [ESC]-Exit      [ENTER]-Select Menu
```

The navigation keys at the bottom of the screen allow you to move through the menus and select the menu options.



The RAID BIOS setup screens shown in this section are for reference only and may not exactly match the items on your screen.



The utility supports maximum four hard disk drives for RAID configuration.

## Creating a RAID set

### To create a RAID set:

1. From the utility main menu, select **1. Create RAID Volume** and press <Enter>. The following screen appears:

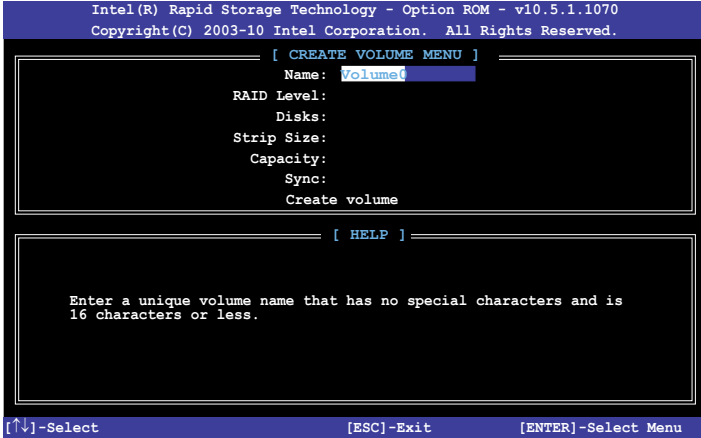

2. Enter a name for the RAID set and press <Enter>.
3. When the RAID Level item is selected, press the up/down arrow key to select a RAID level to create, and then press <Enter>.
4. When the Disks item is selected, press <Enter> to select the hard disk drives you want to include in the RAID set. The SELECT DISKS screen appears:

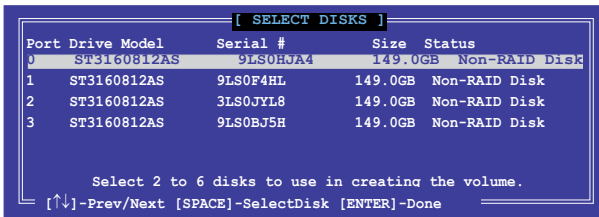

5. Use the up/down arrow key to select a drive, and then press <Space> to select. A small triangle marks the selected drive. Press <Enter> after completing your selection.
6. Use the up/down arrow key to select the stripe size for the RAID array (for RAID 0, 10 and 5 only), and then press <Enter>. The available stripe size values range from 4KB to 128KB. The following are typical values:
  - RAID 0: 128KB
  - RAID 10: 64KB
  - RAID 5: 64KB



---

We recommend a lower stripe size for server systems, and a higher stripe size for multimedia computer systems used mainly for audio and video editing.

---

7. When the **Capacity** item is selected, enter the RAID volume capacity that you want and press <Enter>. The default value indicates the maximum allowed capacity.
8. When the **Create Volume** item is selected, press <Enter>. The following warning message appears:

**WARNING: ALL DATA ON SELECTED DISKS WILL BE LOST.**  
Are you sure you want to create this volume? (Y/N) :

9. Press <Y> to create the RAID volume and return to the main menu, or <N> to go back to the CREATE VOLUME menu.

## Deleting a RAID set



Be cautious when deleting a RAID set. You will lose all data on the hard disk drives when you delete a RAID set.

### To delete a RAID set:

1. From the utility main menu, select **2. Delete RAID Volume** and press <Enter>. The following screen appears:

```
[ DELETE VOLUME MENU ]
Name      Level      Drives  Capacity  Status  Bootable
Volume0   RAID0 (Stripe)  2       298.0GB  Normal  Yes

[ HELP ]

Deleting a volume will reset the disks to non-RAID.

WARNING: ALL DISK DATA WILL BE DELETED.
        (This does not apply to Recovery volumes)

[↑↓]-Select      [ESC]-Previous Menu  [DEL]-Delete Volume
```

2. Use the up/down arrow key to select the RAID set you want to delete, and then press <Delete>. The following warning message appears:

```
[ DELETE VOLUME VERIFICATION ]

ALL DATA IN THE VOLUME WILL BE LOST!
(This does not apply to Recovery volumes)

Are you sure you want to delete volume "Volume0"? (Y/N):
```

3. Press <Y> to delete the RAID set and return to the utility main menu, or press <N> to return to the DELETE VOLUME menu.



## Exiting the Intel® Rapid Storage Technology Option ROM utility

### To exit the utility:

1. From the utility main menu, select **5. Exit**, then press <Enter>. The following warning message appears:

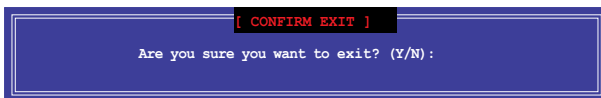

2. Press <Y> to exit or press <N> to return to the utility main menu.

## 5.2 Installing the RAID driver during Windows® OS installation

### To install the RAID driver for Windows® OS:

1. During the OS installation, click **Load Driver** to allow you to select the installation media containing the RAID driver.
2. Insert the USB flash drive with RAID driver into the USB port or the support DVD into the optical drive, and then click **Browse**.
3. Click the name of the device you've inserted, go to **Drivers > RAID**, and then select the RAID driver for the corresponding OS version. Click **OK**.
4. Follow the succeeding screen instructions to complete the installation.



---

Before loading the RAID driver from a USB flash drive, you have to use another computer to copy the RAID driver from the support DVD to the USB flash drive.

---



---

To set up a Windows® UEFI operating system under RAID mode, ensure to load the UEFI driver for your optical drive.

---



# Appendices

## Notices

### Federal Communications Commission Statement

This device complies with Part 15 of the FCC Rules. Operation is subject to the following two conditions:

- This device may not cause harmful interference.
- This device must accept any interference received including interference that may cause undesired operation.

This equipment has been tested and found to comply with the limits for a Class B digital device, pursuant to Part 15 of the FCC Rules. These limits are designed to provide reasonable protection against harmful interference in a residential installation. This equipment generates, uses and can radiate radio frequency energy and, if not installed and used in accordance with manufacturer's instructions, may cause harmful interference to radio communications. However, there is no guarantee that interference will not occur in a particular installation. If this equipment does cause harmful interference to radio or television reception, which can be determined by turning the equipment off and on, the user is encouraged to try to correct the interference by one or more of the following measures:

- Reorient or relocate the receiving antenna.
- Increase the separation between the equipment and receiver.
- Connect the equipment to an outlet on a circuit different from that to which the receiver is connected.
- Consult the dealer or an experienced radio/TV technician for help.



The use of shielded cables for connection of the monitor to the graphics card is required to assure compliance with FCC regulations. Changes or modifications to this unit not expressly approved by the party responsible for compliance could void the user's authority to operate this equipment.

---

## IC: Canadian Compliance Statement

Complies with the Canadian ICES-003 Class B specifications. This device complies with RSS 210 of Industry Canada. This Class B device meets all the requirements of the Canadian interference-causing equipment regulations.

This device complies with Industry Canada license exempt RSS standard(s). Operation is subject to the following two conditions: (1) this device may not cause interference, and (2) this device must accept any interference, including interference that may cause undesired operation of the device.

Cet appareil numérique de la Classe B est conforme à la norme NMB-003 du Canada. Cet appareil numérique de la Classe B respecte toutes les exigences du Règlement sur le matériel brouilleur du Canada.

Cet appareil est conforme aux normes CNR exemptes de licence d'Industrie Canada. Le fonctionnement est soumis aux deux conditions suivantes :

- (1) cet appareil ne doit pas provoquer d'interférences et
- (2) cet appareil doit accepter toute interférence, y compris celles susceptibles de provoquer un fonctionnement non souhaité de l'appareil.

## Canadian Department of Communications Statement

This digital apparatus does not exceed the Class B limits for radio noise emissions from digital apparatus set out in the Radio Interference Regulations of the Canadian Department of Communications.

This class B digital apparatus complies with Canadian ICES-003.

## VCCI: Japan Compliance Statement

### Class B ITE

この装置は、クラスB情報技術装置です。この装置は、家庭環境で使用することを目的としていますが、この装置がラジオやテレビジョン受信機に近接して使用されると、受信障害を引き起こすことがあります。

取扱説明書に従って正しい取り扱いをして下さい。

VCCI-B

This is a Class B product based on the standard of the VCCI Council. If this is used near a radio or television receiver in a domestic environment, it may cause radio interference. Install and use the equipment according to the instruction manual.

## KC: Korea Warning Statement

B급 기기 (가정용 방송통신기자재)

이 기기는 가정용(B급) 전자파적합기기로서 주로 가정에서 사용하는 것을 목적으로 하며, 모든 지역에서 사용할 수 있습니다.

\*당해 무선설비는 전파혼신 가능성이 있으므로 인명안전과 관련된 서비스는 할 수 없습니다.

## REACH

Complying with the REACH (Registration, Evaluation, Authorisation, and Restriction of Chemicals) regulatory framework, we published the chemical substances in our products at ASUS REACH website at <http://csr.asus.com/english/REACH.htm>.



DO NOT throw the motherboard in municipal waste. This product has been designed to enable proper reuse of parts and recycling. This symbol of the crossed out wheeled bin indicates that the product (electrical and electronic equipment) should not be placed in municipal waste. Check local regulations for disposal of electronic products.



DO NOT throw the mercury-containing button cell battery in municipal waste. This symbol of the crossed out wheeled bin indicates that the battery should not be placed in municipal waste.

## ASUS Recycling/Takeback Services

ASUS recycling and takeback programs come from our commitment to the highest standards for protecting our environment. We believe in providing solutions for you to be able to responsibly recycle our products, batteries, other components as well as the packaging materials. Please go to <http://csr.asus.com/english/Takeback.htm> for detailed recycling information in different regions.

## RF Equipment Notices

### CE: European Community Compliance Statement

The equipment complies with the RF Exposure Requirement 1999/519/EC, Council Recommendation of 12 July 1999 on the limitation of exposure of the general public to electromagnetic fields (0–300 GHz). This wireless device complies with the R&TTE Directive.

### Wireless Radio Use

This device is restricted to indoor use when operating in the 5.15 to 5.25 GHz frequency band.

### Exposure to Radio Frequency Energy

The radiated output power of the Wi-Fi technology is below the FCC radio frequency exposure limits. Nevertheless, it is advised to use the wireless equipment in such a manner that the potential for human contact during normal operation is minimized.

## FCC Bluetooth Wireless Compliance

The antenna used with this transmitter must not be co-located or operated in conjunction with any other antenna or transmitter subject to the conditions of the FCC Grant.

## Bluetooth Industry Canada Statement

This Class B device meets all requirements of the Canadian interference-causing equipment regulations.

Cet appareil numérique de la Class B respecte toutes les exigences du Règlement sur le matériel brouilleur du Canada.

## NCC: Taiwan Wireless Statement

### 無線設備的警告聲明

經型式認證合格之低功率射頻電機，非經許可，公司、商號或使用者均不得擅自變更射頻、加大功率或變更原設計之特性及功能。低功率射頻電機之使用不得影響飛航安全及干擾合法通信；經發現有干擾現象時，應立即停用，並改善至無干擾時方得繼續使用。前項合法通信指依電信法規定作業之無線通信。低功率射頻電機須忍受合法通信或工業、科學及醫療用電波輻射性電機設備之干擾。

於 5.25GHz 至 5.35GHz 區域內操作之  
無線設備的警告聲明  
工作頻率 5.250 ~ 5.350GHz 該頻段限於室內使用。

## Japan RF Equipment Statement

この製品は、周波数帯域5.15～5.35GHzで動作しているときは、室内においてのみ使用可能です。

## KC (RF Equipment)

대한민국 규정 및 준수

방통위고시에 따른 고지사항

해당 무선설비는 운용 중 전파혼신 가능성이 있음,

이 기기는 인명안전과 관련된 서비스에 사용할 수 없습니다.

## Google™ License Terms

Copyright© 2014 Google Inc. All Rights Reserved.

Licensed under the Apache License, Version 2.0 (the "License"); you may not use this file except in compliance with the License. You may obtain a copy of the License at:

<http://www.apache.org/licenses/LICENSE-2.0>

Unless required by applicable law or agreed to in writing, software distributed under the License is distributed on an "AS IS" BASIS, WITHOUT WARRANTIES OR CONDITIONS OF ANY KIND, either express or implied.

See the License for the specific language governing permissions and limitations under the License.

## ASUS contact information

### ASUSTeK COMPUTER INC.

Address 15 Li-Te Road, Peitou, Taipei, Taiwan 11259  
Telephone +886-2-2894-3447  
Fax +886-2-2890-7798  
E-mail [info@asus.com.tw](mailto:info@asus.com.tw)  
Web site [www.asus.com.com/](http://www.asus.com.com/)

#### **Technical Support**

Telephone +86-21-38429911  
Fax +86-21-5866-8722, ext. 9101#  
Online support <http://www.asus.com/tw/support/>

### ASUS COMPUTER INTERNATIONAL (America)

Address 800 Corporate Way, Fremont, CA 94539, USA  
Telephone +1-510-739-3777  
Fax +1-510-608-4555  
Web site <http://www.asus.com/us/>

#### **Technical Support**

Support fax +1-812-284-0883  
Telephone +1-812-282-2787  
Online support <http://www.service.asus.com/>

### ASUS COMPUTER GmbH (Germany and Austria)

Address Harkort Str. 21-23, D-40880 Ratingen, Germany  
Fax +49-2102-959911  
Web site <http://www.asus.com/de>  
Online contact <http://eu-rma.asus.com/sales>

#### **Technical Support**

Telephone +49-1805-010923\*  
Support Fax +49-2102-9599-11  
Online support <http://www.asus.com/de/support/>

**DECLARATION OF CONFORMITY**

Per FCC Part 2, Section 2.1077(a)



Responsible Party Name: **Asus Computer International**

Address: 800 Corporate Way, Fremont, CA 94539.

Phone/Fax No: (510)739-3777/(510)608-4555

hereby declares that the product

**Product Name :** Motherboard

**Model Number :** GRYPHON Z97 ARMOR EDITION,GRYPHON Z97

Conforms to the following specifications:

- FCC Part 15, Subpart B, Unintentional Radiators

**Supplementary Information:**

This device complies with part 15 of the FCC Rules. Operation is subject to the following two conditions: (1) This device may not cause harmful interference, and (2) this device must accept any interference received, including interference that may cause undesired operation.

Representative Person's Name : Steve Chang / President

Signature :

Date : Apr. 16, 2014

**EC Declaration of Conformity**



We, the undersigned,

Manufacturer: ASUSTEK COMPUTER INC.  
 Address: 4F, No. 150, Li-Tze Rd., PEITOU, TAIPEI 112, TAIWAN  
 Authorized representative in Europe: ASUS COMPUTER GmbH  
 Address: HARKORT STR. 21-23, 40880 RATINGSSEN  
 Country: GERMANY

declare the following apparatus:

Product name : Motherboard  
 Model name : GRYPHON Z97 ARMOR EDITION,GRYPHON Z97

conform with the essential requirements of the following directives:

- 2004/108/EC-EMC Directive
  - EN 55028:2010
  - EN 55024:2010
  - EN 55014:2011/A1:2005-A2:2006
- 1989/532/EEC-RADTE Directive
  - EN 55028:2010
  - EN 55024:2010
  - EN 55014:2011/A1:2005-A2:2006

- 2006/95/EC-LVD Directive
  - EN 60950-1: A12:2011
- 2009/125/EC-EP Directive
  - Regulation (EC) No. 1275/2008
  - Regulation (EC) No. 642/2009
- 2011/65/EU-RoHS Directive
  - CE marking



(EC conformity marking)

Position : CEO  
 Name : Jerry Shen

Signature : \_\_\_\_\_

Declaration Date: 16/04/2014  
 Year to begin affixing CE marking: 2014