

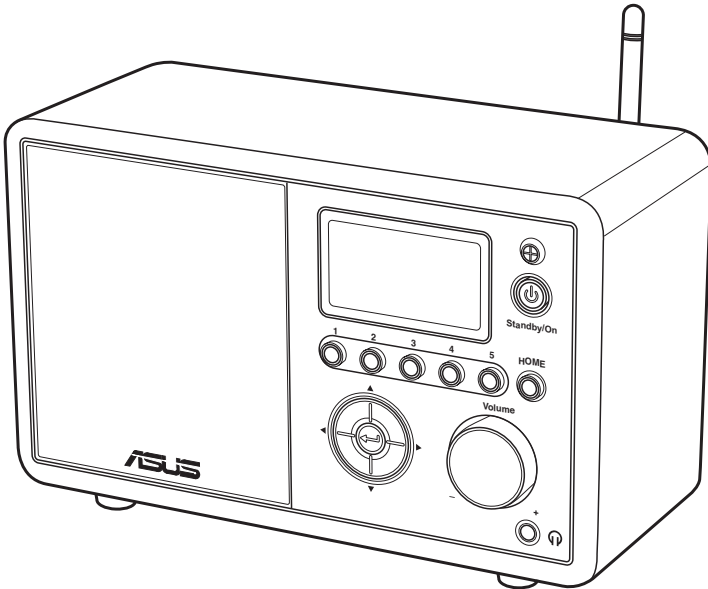

# ASUS Internet Radio

## User Manual



**AIR**

# Contents

---

<b>Notices</b> .....	<b>iv</b>
<b>Welcome</b> .....	<b>vi</b>
Package contents.....	vi
Overview .....	vii
Specifications .....	vii
<b>Getting started</b> .....	<b>1</b>
Front view .....	1
Rear view.....	2
Using the remote control.....	3
Turning on the device .....	4
Language selection .....	5
Text entry .....	6
Connecting the device to the network.....	6
Establishing a wired connection .....	6
Establishing a wireless connection .....	7
<b>Listening to the radio</b> .....	<b>9</b>
Searching for a radio station.....	9
Searching by genre .....	9
Searching by country/location .....	9
Searching by station name.....	10
Connecting to a station .....	11
Adding a station to My Favorite.....	11
Adding a currently played radio station.....	11
Adding a radio station from the list .....	12
Adding a manually entered station.....	12
Managing My Favorite.....	13
<b>Other settings</b> .....	<b>14</b>
Configuration .....	14
Network.....	14

# Contents

---

Clock .....	14
Alarm .....	14
Language .....	15
Backlight .....	15
Sleep Timer.....	15
Buffer .....	15
Version Update .....	16
Reset .....	16
<b>Troubleshooting .....</b>	<b>17</b>

# Notices

---

## **Federal Communications Commission Interference Statement**

This equipment has been tested and found to comply with the limits for a Class B digital device, pursuant to Part 15 of the FCC Rules. These limits are designed to provide reasonable protection against harmful interference in a residential installation. This equipment generates, uses and can radiate radio frequency energy and, if not installed and used in accordance with manufacturer's instructions, may cause harmful interference to radio communications. However, there is no guarantee that interference will not occur in a particular installation. If this equipment does cause harmful interference to radio or television reception, which can be determined by turning the equipment off and on, the user is encouraged to try to correct the interference by one or more of the following measures:

- Reorient or relocate the receiving antenna.
- Increase the separation between the equipment and receiver.
- Connect the equipment to an outlet on a circuit different from that to which the receiver is connected.
- Consult the dealer or an experienced radio/TV technician for help.

This device complies with Part 15 of the FCC Rules. Operation is subject to the following two conditions:

- This device may not cause harmful interference, and
- This device must accept any interference received including interference that may cause undesired operation.

### *FCC Caution:*

Any changes or modifications not expressly approved by the party responsible for compliance could void the user's authority to operate this equipment.

**IMPORTANT NOTE:****FCC Radiation Exposure Statement**

This equipment complies with FCC radiation exposure limits set forth for an uncontrolled environment. **This equipment should be installed and operated with a minimum distance of 20cm between the radiator and your body.** This transmitter must not be co-located or operated in conjunction with any other antenna or transmitter. IEEE 802.11b or 802.11g operation of this product in the U.S.A. is firmware-limited to channels 1 through 11.

**Industry Canada Statement**

Operation is subject to the following two conditions:

- This device may not cause interference and
- This device must accept any interference, including interference that may cause undesired operation of the device.

**IMPORTANT NOTE:****Radiation Exposure Statement**

This equipment complies with IC radiation exposure limits set forth for an uncontrolled environment. **This equipment should be installed and operated with a minimum distance of 20cm between the radiator and your body.**

# Welcome

---

Congratulations on your purchase of the ASUS Internet Radio. The following illustration displays the package contents of your new ASUS Internet Radio.

## Package contents

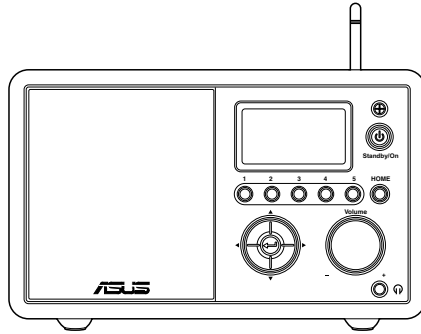

**ASUS Internet Radio**



**Remote control**

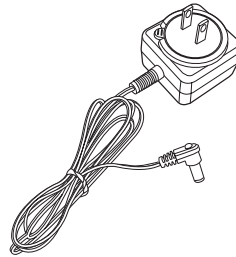

**AC power adapter**

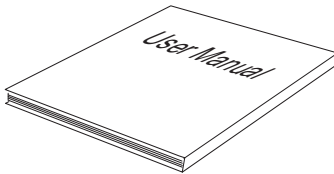

**User manual**

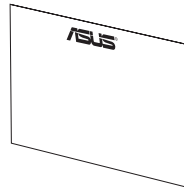

**Warranty card**

## Overview

The ASUS Internet Radio provides easy access to a wide selection of radio stations on the Internet. Before enjoying your ASUS Internet Radio, make sure that you have access to a wired/ wireless network.

## Features

- Stand-alone device
- Wireless/cable connection
- Up-to-date list of more than 10,000 online stations
- 250 favorites
- Alarm clock
- Sleep timer
- Network Time Protocol (NTP)

## Specifications

Connectivity	Wireless LAN 802.11b/g Wired 10/100M Ethernet
Data rates	54 Mbits (WLAN) 10/100 Mbits (Ethernet)
Wireless LAN security	64/128-bit WEP WPA/WPA2
Audio format decoder	MP3/WMA 16Kbps~320Kbps
SNR	>90dB earphone
Display	128 x 64 FSTN graphics display Blue color with white LED
I/O ports	Headphone jack (Φ 3.5mm) Line In (Φ 3.5mm) Line Out (RCA jack) Ethernet (RJ45) DC power jack

Speaker	5 Watt/4 Ohm
Language	English, French, German, Spanish, Japanese, Korean, Traditional Chinese, Simplified Chinese
AC power adapter	Input: AC 100-240V (50-60Hz) Output: DC 6V/2A
Remote control	26 keys
Dimension	250 (L) x 128 (W) x 190 (H) mm
ADSL/Cable Modem bandwidth (recommended)	1M bps at least



# Getting started

---

## Front view

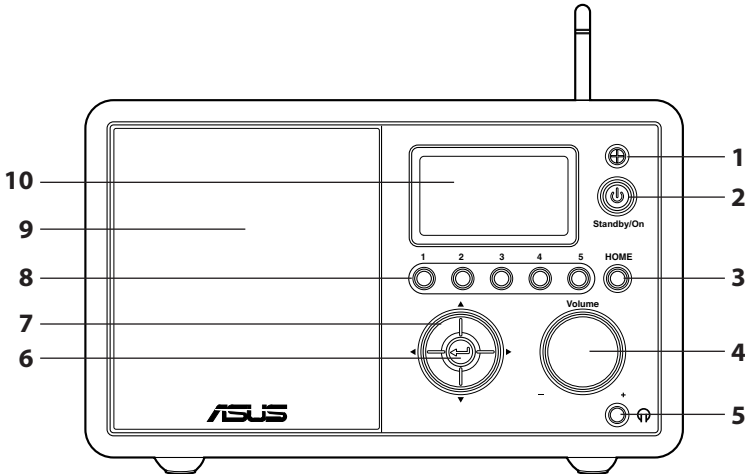

1. **IR sensor:** Receives commands from the remote control.
2. **Standby/On button:** Press to switch the device between standby and on mode.
3. **Home button:** Press to return to the main menu.
4. **Volume knob:** Rotate to the right to increase the volume or to the left to decrease the volume. Rotate to enter text or to scroll up/down through menu options. Press to confirm your selection of a menu option.
5. **Headphone jack:** Connect headphones to this jack for private listening. You can also connect additional speaker(s) to this jack using an audio cable.
6. **Enter button:** Press to confirm your selection of a menu option.
7. **Up/down/left/right navigation button:** Press to scroll up/down/left/right through menu items.
8. **Preset button 1~5:** Press to recall a preset radio station.
9. **Speaker:** The built-in speaker.
10. **Display:** The LCD display with backlight.

**NOTE:** The front panel functions are repeated on the remote control. Refer to page 3 and 4 for more information.

## Rear view

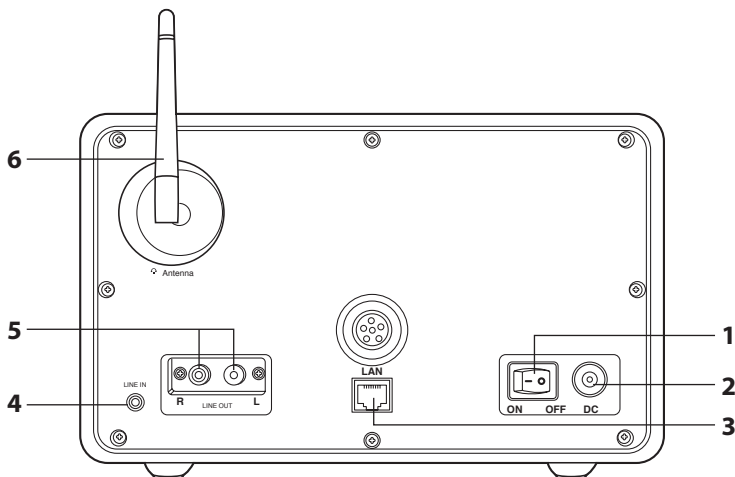







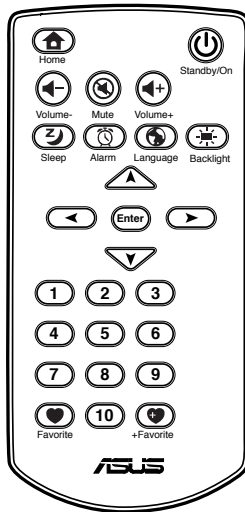

- 1. Power switch:** Turn on/off the device.
- 2. DC power jack:** Connect the supplied power cord to this jack.
- 3. LAN port:** Connect a network cable to this port.
- 4. Line In jack:** If you intend to use the device solely as a speaker, connect an audio cable to this jack. The device will automatically switch to AUX mode.
- 5. Left/right Line Out jack:** Connect audio cables to these jacks to use an additional stereo.
- 6. Antenna:** Set the antenna to a vertical position to ensure best reception of wireless signal.









## Using the remote control

Use the remote control to search for radio stations, make a list of your favorite stations, and configure other settings.

Refer to the table below for the remote control buttons and their functions.



	Standby/On button	Press to switch the device between standby and on mode.
	Home button	Press to return to the main menu.
	Volume- button	Press to decrease the output volume.
	Mute button	Press to mute the audio output.
	Volume+ button	Press to increase the output volume.
	Sleep button	Press to select a preset amount of time after which the device shuts off.
	Alarm button	Press to turn on/off the alarm clock.
	Language button	Press to select a menu language.

	Backlight button	Press to select a backlight mode.
	Enter button	Press to confirm your selection of a menu option.
	Up navigation button	Press to scroll up through menu items. Press to select text.
	Down navigation button	Press to scroll down through menu items. Press to select text.
	Left navigation button	Press to go back to the previous menu.
	Right navigation button	Press to confirm your selection of an option and go to the submenu.
	Preset button 1~10	Press to recall a preset radio station.
	Favorite button	Press to display your favorites list.
	+Favorite button	Press to store the currently played radio station to your favorites list.

## Turning on the device

To turn on your ASUS Internet Radio for the first time:

1. Plug the supplied power adapter in a power outlet.
2. Connect the power adapter to the DC power jack on the rear panel.
3. Press the power switch  on the rear panel to turn on the device. The display lights up to show the ASUS logo, and then the following main menu appears:

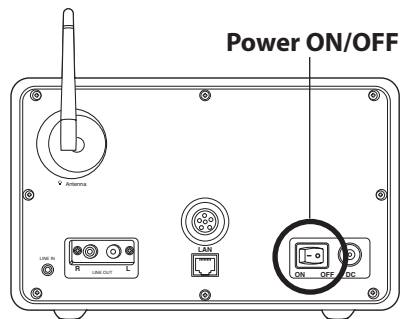

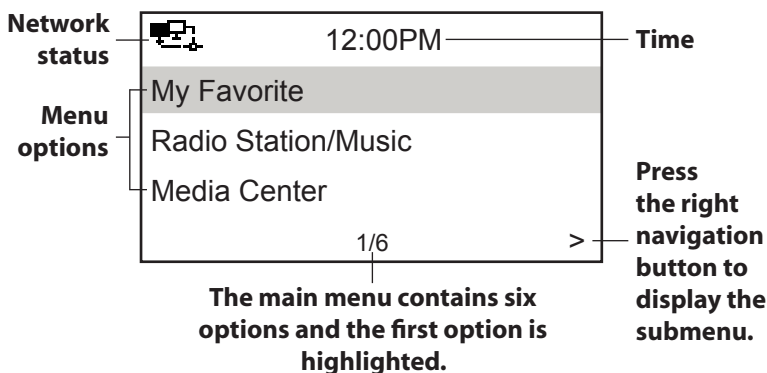

**NOTE:** Pressing the  button on the front panel or on the remote control does not turn the device on.

## Language selection

The ASUS Internet Radio supports up to eight languages for the menu options. You can change the language to English, German, Spanish, French, Traditional Chinese, Simplified Chinese, Japanese, or Korean.

To change the language:

Press the **Language** button  on the remote control to select the language you use (the fastest way).

OR:

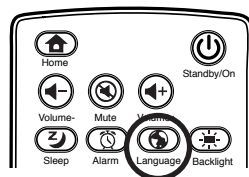

**Language button**

1. From the main menu, select **Configuration > Language**.
2. Press the up/down navigation button to scroll through the language options and press **Enter** to apply the selected language.

**NOTE:** The language selected applies to the device menus and system messages only. The station names shown vary according to station locations.

## Text entry

When you add the URL of an online radio station or use a WEP/WPA key for wireless network security, you need to enter text.

To enter upper/lower case letters, symbols, or numbers:

1. Press the up/down navigation button or rotate the volume knob clockwise/counterclockwise to select a character from the following:  
A a B b...Z z \$ % & # \_ ^ ~ ` " ' , . ; ? ! \* - + @ < = > { | } [ \ ] ( / ) 0  
1...9 delete  space
2. Press the right navigation button to proceed to the next. Press **Enter** or the volume knob when done.

**NOTE:** To delete text, highlight a character and select . The character will be deleted whether you proceed to the right or the left.

To enter your IP address and other IP parameters or set the time, date and alarm, follow the steps described above.



## Connecting the device to the network

Before enjoying online radio stations worldwide, you must first connect your ASUS Internet Radio to the network via a wired or wireless connection. Plugging in a network cable automatically disables the WLAN function.

### Establishing a wired connection

*Using an IP address assigned via DHCP:*

1. Plug a network cable in the LAN port to connect the device to a router or a wireless access point (the device does not support PPPoE connection).
2. From the main menu, select **Configuration > Network > IP Configuration > Auto Setting (DHCP)**.
3. Press **Enter** to make a connection. The following icons will appear at the upper left corner of the display to indicate network status:

	Connecting
	Wired connection successful
	Wired connection failed

*Using a fixed IP address:*

1. Plug a network cable in the LAN port to connect the device to a router or a wireless access point (the device does not support PPPoE connection).
2. From the main menu, select **Configuration > Network > IP Configuration > Manual Setting**.
3. Press **Enter** and select **IP Address**. Fill-in the values and press **Enter** when finished. Refer to the "Text entry" section for details about inputting numbers.
4. Enter **Subnet Mask, Default Gateway, Preferred DNS Server, Alternate DNS Server** in the same fashion, and then select **Direct Connection** to make a connection.
5. Refer to the table above for network status.



**NOTE:** If a connection is established successfully, the device saves the IP address and related values. With network settings unchanged, the device will automatically connect to the network when powered on.

## Establishing a wireless connection

1. Set up your wireless access point (AP) to receive/broadcast a wireless signal.
2. From the main menu, select **Configuration > Network > WiFi Configuration**. The names of the receivable access points are listed. If you highlight a network protected by WEP/WPA encryption, a key icon  will show at the bottom of the display.
3. Select a network you have access to. If the network is not secured by a WEP/WPA key, press **Enter** to make a connection. If it is locked, press the right navigation button and select **Enter WEP/WPA**.

**NOTE:** The device does not support WiFi hotspots that require user authentication.

4. Input the appropriate key and press **Enter** to make a connection. Refer to the "Text entry" section for details about inputting text.
5. The following icons will appear at the upper left corner of the display to indicate network status:

	Connecting
	Wireless connection successful
	Wireless connection failed

**NOTE:**

- Do not plug in a network cable when choosing a wireless connection.
- If a connection is established successfully, the device saves the WEP/WPA key. With network settings unchanged, the device will automatically connect to the network when powered on.



# Listening to the radio

## Searching for a radio station

The ASUS Internet Radio has an up-to-date, well-classified list of online radio stations worldwide. Not every internet radio station has a corresponding traditional radio station. Some of them broadcast via the Internet only. You can search for a station by music genre or location. You can also go through the stations categorized in alphabetical order.

### Searching by genre

1. From the main menu, select **Radio Station/Music > Genre**, and a list of music genres displays in alphabetical order.
2. Press the up/down navigation button to highlight a genre. For example, if you want to listen to jazz music:

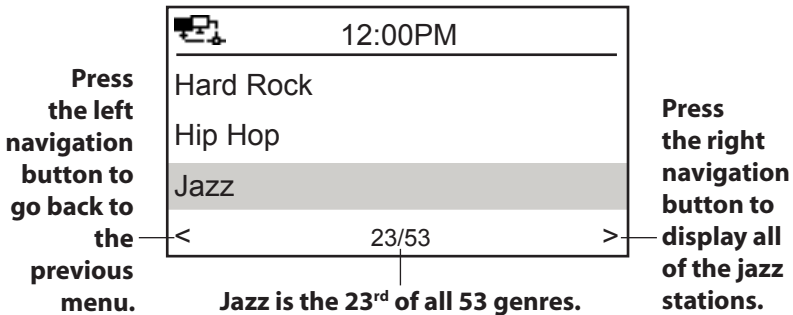

3. Press the right navigation button to display all jazz stations available. Highlight a station and press **Enter** to connect to the station.

### Searching by country/location

1. From the main menu, select **Radio Station/Music > Country/Location**, and a list of geographical regions displays in alphabetical order.

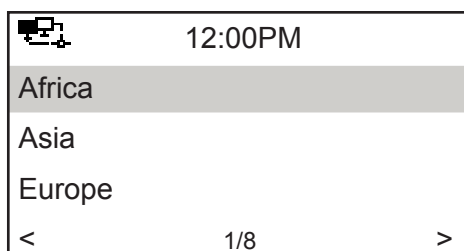

The list includes: Africa, Asia, Europe, Latin America, Middle East, North America, Oceania/Pacific, and Internet Only.

2. Select a geographical region and then select a country in the region. A list of stations located in the country displays.
3. Highlight a station and press **Enter** to connect to the station.

**NOTE:**

- For countries that have a huge number of radio stations, the stations are sub-classified by name initial alphabetically.
- If you select a language other than English, you will see the name of a country where that language is spoken in the **Radio Station/Music** menu. Highlight the country name and press **Enter** to display the stations located in this country.

## Searching by station name

1. From the main menu, select **Service > Search Radio Station**.
2. The stations are divided into 10 categories by their name initial: **0-9, A-C, D-F, G-I, J-L, M-O, P-R, S-U, V-Z**, and **Other**. Select a category and a list of stations displays.

**NOTE:** Stations with names in Japanese, Korean, Traditional Chinese, and Simplified Chinese are in the **Other** group.

3. Select any of the stations again to display more stations. The stations are listed alphabetically according to the first two letters of their names.
4. Highlight a station and press **Enter** to connect to the station.

**NOTE:** When you highlight a station from the lists, vertical bars ■■■ appear at the bottom left corner of the display to indicate the accessibility to the station. Three bars suggest the highest accessibility.

## Connecting to a station

If your ASUS Internet Radio is successfully connected to a station, the display is as follows:

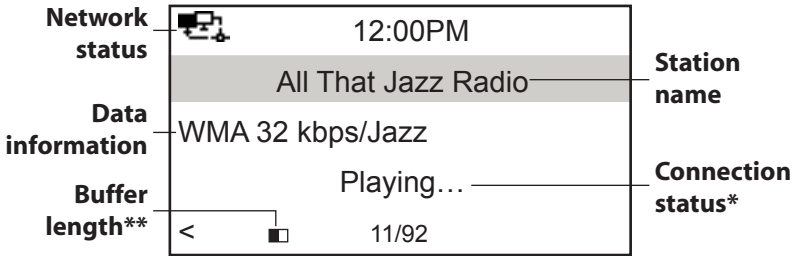

### NOTE:

- \*The connection status may change from “Connecting” to “Buffering” to “Playing.” Press **Enter** to stop playing and go back to the previous menu.
- \*\*Refer to page 15 for details about setting the buffer.
- If you shift to the main menu while connecting to a station, a countdown timer will appear at the bottom right corner of the display. After a lapse of 10 seconds, the system automatically shifts back to the station being played.

## Adding a station to My Favorite

You can add a currently played radio station or one found on the list to My Favorite. You can also manually enter the URL of a station and add it to your favorites list. The ASUS Internet Radio has a memory of 250 stations.

### Adding a currently played radio station

1. Press the **+Favorite** button (♥) on the remote control.
2. The following icons will appear next to the network status icon to indicate favorites status:

	The station is being added to My Favorite.
	The station has already been in My Favorite.
	Favorites exceeds the maximum of 250.

## Adding a radio station from the list

1. Search for a station using any of the methods mentioned in the “Searching for a radio station” section.
2. Highlight a station and press the right navigation button to display the submenu as the following:

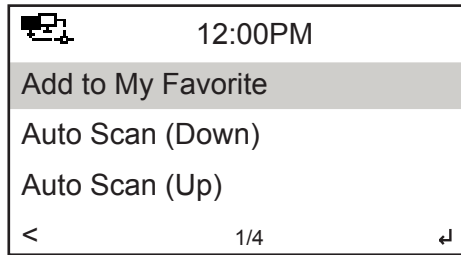

3.
  - **Add to My Favorite:** Select to add the station to your favorites list.
  - **Auto Scan (Down)/(Up):** Select to connect to the stations on the list consecutively up/down from the highlighted station. Each station will be played for 30 seconds during which you can add it to My Favorite by pressing the **+Favorite** button (❤️).
  - **Play:** Select to connect to the station.

Refer to the table on page 11 for favorites status.

## Adding a manually entered station

1. From the main menu, select **Service > Add New Radio Station**.
2. Enter the URL of a station. Refer to the “Text entry” section for details about inputting text.
3. When finished, press **Enter** to add it to your favorites list. Refer to the table on page 11 for favorites status.

## Managing My Favorite

The ASUS Internet Radio saves up to 250 stations to My Favorite so that you can have quick access to preset stations.

To manage your favorites list:

1. Press the **Favorite** button (♥) on the remote control or select **My Favorite** from the main menu. A list of preset stations displays.
2. Highlight a station on the list and press the right navigation button to display the submenu as the following:

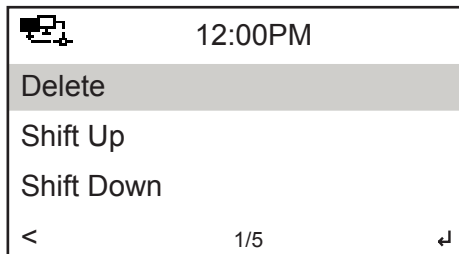

3.
  - **Delete:** Select to delete the station.
  - **Shift Up/Down:** Select to change the order of the preset stations. Move the stations played the most frequently to the top 5 or 10 so that you can press the preset buttons to switch to them.
  - **Rename:** Select to rename the station.
  - **Play:** Select to connect to the station.

You can also connect to a preset station by doing the following:

- From your favorites list, highlight a station and press **Enter** to connect.
- From any menus, press the preset button 1~5 on the front panel or the remote control to connect to your top 5 preset stations.
- From any menus, press the preset button 6~10 on the remote control to connect to the sixth to the tenth preset stations.

# Other settings

---

## Configuration

Selecting **Configuration** from the main menu allows you to configure the ASUS Internet Radio setups including network, clock, alarm, language, backlight, sleep timer, buffer, version update, and reset.

## Network

Refer to pages 6~8 for details about network setup.

## Clock

The **Configuration > Clock** option allows you to set the time/date and a format for displaying time. Set the time for the device when you turn it on for the first time. Through **Network Time Protocol (NTP)**, a clock synchronization solution on the Internet, the device will synchronize its clock with accuracy as long as it is connected to the network.

- **Set Date and Time:** Select to set the time and date. Refer to the "Text entry" section for details about inputting numbers.
- **Set Time Format:** Select between the **12Hour** and **24Hour** format.

## Alarm

This option allows you to turn on/off the alarm and program an alarm. Pressing the **Alarm** button  on the remote control also activates/deactivates a programmed alarm.

To program an alarm:

1. Go to **Configuration > Alarm > Turn On**.
2. Select **Set Alarm Time** and enter values. Refer to the "Text entry" section for details about inputting numbers.
3. Select **Set Alarm Sound** to choose a sound type from **Beep**, **Melody**, and **Radio** (the station you last listen to).

4. The  icon will appear at the upper right corner of the display to indicate that the alarm function is activated.

Make sure that the device is not connecting to any stations at the set time, or the alarm will not set off. When the alarm sets off, press any button to stop it.

## Language



Refer to page 5 for details about language selection.

## Backlight

The **Configuration > Backlight** option allows you to adjust the brightness of the backlight. You can also shift the backlight mode by pressing the **Backlight** button  on the remote control. Three modes are available:

- **Turn Off:** Select to turn off the backlight.
- **Power Saving:** Select to turn down the backlight.
- **Turn On:** Select to turn on the backlight.

## Sleep Timer

The **Configuration > Sleep Timer** option allows you to select a preset amount of time after which the device shuts off. You can also set the sleep timer by pressing the **Sleep** button  on the remote control. When this function is activated, the XXX  icon will appear at the upper right corner of the display, XXX signifying the minutes left. Six options are available: **Turn Off**, **15 Minutes**, **30 Minutes**, **60 Minutes**, **90 Minutes**, and **120 Minutes**.

## Buffer

The **Configuration > Buffer** option allows you to set the buffer to hold data received for a certain amount of time. Setting a longer buffer makes the data transfer more smoothly but takes

you longer to wait. If you are connecting to a station, there will be an icon signifying the buffer length you set:

- **2 Seconds:**
- **4 Seconds:**
- **8 Seconds:**

## Version Update

This option allows you to download the latest firmware and list of online radio stations for the device.

To update the firmware version:

1. Go to **Configuration > Version Update** and select the item you are allowed to download.
2. Select **Yes** to begin downloading it. Wait for a few seconds until the device reboots.

**NOTE:** Do not turn off the device while the update is proceeding.

## Reset

The **Configuration > Reset** option allows you to reset the device to its factory default settings. Your favorites lists will not be erased.



# Troubleshooting

---

Read the following Q&As for troubleshooting guide. If these do not give you answers, you may contact us directly at the contact information provided on this manual's inside cover.

## ***The display shows that a music station is being played, but I cannot hear anything.***

Some stations may not have 24-hour broadcasts. You cannot hear anything if the stations do not send out any programs.

## ***Why is it that I cannot hear anything from the speaker?***

- Either your ASUS Internet Radio is muted or the volume is so low that you cannot hear anything. Turn up the volume or press the **Mute** button  to cancel the muted mode. If you are using additional speakers, make sure that the connected speaker system is powered on.
- If the above steps make no difference, reboot the device.

## ***What can I do if my ASUS Internet Radio crashes?***

Press the power switch on the rear panel to turn off the device, and then switch it on again.

## ***I have set the alarm but it did not set off.***

The alarm will not set off while you are connecting to a station.

## ***The wireless connection is not stable.***

- Establish a wired connection to test if your network is reliable.
- If the wired connection is more stable than the wireless one, use the LAN connection instead.

## ***Why do I need to update the Internet Radio?***

The URLs of the internet radio stations may change, so the ASUS technicians update them regularly. You need to update your ASUS Internet Radio to get the latest list of stations.

### ***How can I tell if the update is successful?***

- When you start the update process, a countdown timer displays to count from 60 seconds. If the device reboots at around 57 seconds, it means that your current firmware version has been the latest. If the timer continues to count until the device reboots, the update is successful.
- Go to **Configuration > Version Update** to check if the version name is different from the previous one.

### ***I cannot connect to certain stations.***

The accessibility to online radio stations vary with the network bandwidth in different countries. Failed connections may be due to the following:

- The network bandwidth in the country you want to connect to is narrow. We recommend an ADSL/Cable Modem bandwidth of at least 1M bps.
- Internet congestion.
- The URLs of the stations have changed. Update the device and try again. If you still cannot connect to the stations, contact us at <http://vip.asus.com/eservice/techserv.aspx>.
- The stations do not provide enough bandwidth.
- The stations are under repair or no longer exist.