

**ASUS<sup>®</sup>**

# Terminator 2

*Barebone System*

*Model T2-AH1*

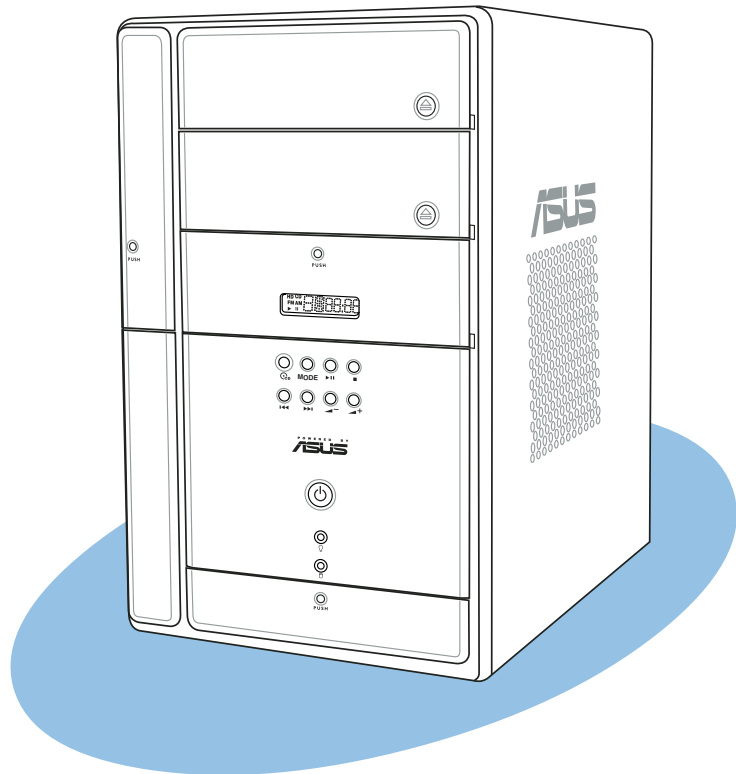

**E2065**

**First Edition V1  
August 2005**

**Copyright © 2005 ASUSTeK COMPUTER INC. All Rights Reserved.**

No part of this manual, including the products and software described in it, may be reproduced, transmitted, transcribed, stored in a retrieval system, or translated into any language in any form or by any means, except documentation kept by the purchaser for backup purposes, without the express written permission of ASUSTeK COMPUTER INC. (“ASUS”).

Product warranty or service will not be extended if: (1) the product is repaired, modified or altered, unless such repair, modification or alteration is authorized in writing by ASUS; or (2) the serial number of the product is defaced or missing.

ASUS PROVIDES THIS MANUAL “AS IS” WITHOUT WARRANTY OF ANY KIND, EITHER EXPRESS OR IMPLIED, INCLUDING BUT NOT LIMITED TO THE IMPLIED WARRANTIES OR CONDITIONS OF MERCHANTABILITY OR FITNESS FOR A PARTICULAR PURPOSE. IN NO EVENT SHALL ASUS, ITS DIRECTORS, OFFICERS, EMPLOYEES OR AGENTS BE LIABLE FOR ANY INDIRECT, SPECIAL, INCIDENTAL, OR CONSEQUENTIAL DAMAGES (INCLUDING DAMAGES FOR LOSS OF PROFITS, LOSS OF BUSINESS, LOSS OF USE OR DATA, INTERRUPTION OF BUSINESS AND THE LIKE), EVEN IF ASUS HAS BEEN ADVISED OF THE POSSIBILITY OF SUCH DAMAGES ARISING FROM ANY DEFECT OR ERROR IN THIS MANUAL OR PRODUCT.

SPECIFICATIONS AND INFORMATION CONTAINED IN THIS MANUAL ARE FURNISHED FOR INFORMATIONAL USE ONLY, AND ARE SUBJECT TO CHANGE AT ANY TIME WITHOUT NOTICE, AND SHOULD NOT BE CONSTRUED AS A COMMITMENT BY ASUS. ASUS ASSUMES NO RESPONSIBILITY OR LIABILITY FOR ANY ERRORS OR INACCURACIES THAT MAY APPEAR IN THIS MANUAL, INCLUDING THE PRODUCTS AND SOFTWARE DESCRIBED IN IT.

Products and corporate names appearing in this manual may or may not be registered trademarks or copyrights of their respective companies, and are used only for identification or explanation and to the owners’ benefit, without intent to infringe.

# Table of contents

Notices .....	vi
Safety information .....	vii
About this guide .....	viii
System package contents .....	x

## Chapter 1: System Introduction

1.1 Welcome! .....	1-2
1.2 Front panel (external) .....	1-2
1.3 Front panel (internal) .....	1-5
1.4 Rear panel .....	1-7
1.5 Internal components .....	1-9
1.6 LED panel .....	1-10

## Chapter 2: Basic Installation

2.1 Preparation .....	2-2
2.2 Before you proceed .....	2-2
2.3 Removing the cover .....	2-3
2.4 Removing the power supply .....	2-4
2.5 Installing a CPU .....	2-5
2.5.1 CPU installation .....	2-5
2.5.2 Installing the CPU fan and heatsink assembly .....	2-7
2.5.3 Removing the CPU fan and heatsink assembly .....	2-8
2.6 Installing a DIMM .....	2-9
2.6.1 Memory configurations .....	2-9
2.6.2 DIMM installation .....	2-13
2.7 Installing an expansion card .....	2-14
2.7.1 Expansion slots .....	2-14
2.7.2 Expansion card installation .....	2-15
2.8 Installing an optical drive .....	2-17
2.9 Installing a floppy disk drive .....	2-20
2.10 Installing a hard disk drive (HDD) .....	2-21
2.11 Reinstalling the power supply unit .....	2-24
2.12 Replacing the cover .....	2-26

# Table of contents

## Chapter 3: Starting up

3.1	Installing an operating system .....	3-2
3.2	Powering up .....	3-2
3.3	Support CD information .....	3-2
3.3.1	Running the support CD .....	3-3
3.3.2	Drivers menu .....	3-3
3.3.3	Utilities menu .....	3-4
3.3.4	Make Disk menu .....	3-6
3.3.5	ASUS contact information .....	3-7
3.3.6	Other information .....	3-7
3.4	Software information .....	3-8
3.4.1	ASUS Radio Player .....	3-8
3.4.2	ASUS Instant Music .....	3-10
3.4.3	Audio DJ .....	3-12
3.4.4	Marvell® Yukon Virtual Cable Tester .....	3-14
3.4.5	Cool 'n' Quiet!™ Technology .....	3-15
3.4.6	ASUS PC Probe II .....	3-17
3.4.7	AC`97 audio feature .....	3-23

## Chapter 4: Motherboard Info

4.1	Introduction .....	4-2
4.2	Motherboard layout .....	4-2
4.3	Jumper .....	4-3
4.4	Connectors .....	4-4

## Chapter 5: BIOS Information

5.1	Managing and updating your BIOS .....	5-2
5.1.1	Creating a bootable floppy disk .....	5-2
5.1.2	ASUS EZ Flash utility .....	5-3
5.1.3	AFUDOS utility .....	5-4
5.1.4	ASUS CrashFree BIOS 2 utility .....	5-6
5.1.5	ASUS Update utility .....	5-8
5.2	BIOS setup program .....	5-11
5.2.1	BIOS menu screen .....	5-12
5.2.2	Menu bar .....	5-12
5.2.3	Navigation keys .....	5-12
5.2.4	Menu items .....	5-13

## Table of contents

5.2.5	Sub-menu items .....	5-13
5.2.6	Configuration fields .....	5-13
5.2.7	Pop-up window .....	5-13
5.2.8	Scroll bar .....	5-13
5.2.9	General help .....	5-13
5.3	Main menu .....	5-14
5.3.1	System Time .....	5-14
5.3.2	System Date .....	5-14
5.3.3	Legacy Diskette A .....	5-14
5.3.4	IDE Master/Slave .....	5-15
5.3.5	System Information .....	5-16
5.4	Advanced menu .....	5-17
5.4.1	Instant Music Configuration .....	5-17
5.4.2	JumperFree Configuration .....	5-18
5.4.3	LAN Cable Status .....	5-21
5.4.4	USB Configuration .....	5-22
5.4.5	CPU Configuration .....	5-23
5.4.6	Chipset .....	5-24
5.4.7	Onboard Devices Configuration .....	5-26
5.4.8	PCI Express Configuration .....	5-27
5.4.9	PCI PnP .....	5-28
5.5	Power menu .....	5-29
5.5.1	Suspend Mode .....	5-29
5.5.2	Repost Video on S3 Resume .....	5-29
5.5.3	ACPI 2.0 Support .....	5-29
5.5.4	ACPI APIC Support .....	5-29
5.5.5	APM Configuration .....	5-30
5.5.6	Hardware Monitor .....	5-32
5.6	Boot menu .....	5-33
5.6.1	Boot Device Priority .....	5-33
5.6.2	Boot Settings Configuration .....	5-34
5.6.3	Security .....	5-35
5.7	Exit menu .....	5-37

## Appendix

Power supply specifications .....	A-2
-----------------------------------	-----

# Notices

## Federal Communications Commission Statement

This device complies with Part 15 of the FCC Rules. Operation is subject to the following two conditions:

- This device may not cause harmful interference, and
- This device must accept any interference received including interference that may cause undesired operation.

This equipment has been tested and found to comply with the limits for a Class B digital device, pursuant to Part 15 of the FCC Rules. These limits are designed to provide reasonable protection against harmful interference in a residential installation. This equipment generates, uses and can radiate radio frequency energy and, if not installed and used in accordance with manufacturer's instructions, may cause harmful interference to radio communications. However, there is no guarantee that interference will not occur in a particular installation. If this equipment does cause harmful interference to radio or television reception, which can be determined by turning the equipment off and on, the user is encouraged to try to correct the interference by one or more of the following measures:

- Reorient or relocate the receiving antenna.
- Increase the separation between the equipment and receiver.
- Connect the equipment to an outlet on a circuit different from that to which the receiver is connected.
- Consult the dealer or an experienced radio/TV technician for help.



---

**WARNING!** The use of shielded cables for connection of the monitor to the graphics card is required to assure compliance with FCC regulations. Changes or modifications to this unit not expressly approved by the party responsible for compliance could void the user's authority to operate this equipment.

---

## Canadian Department of Communications Statement

This digital apparatus does not exceed the Class B limits for radio noise emissions from digital apparatus set out in the Radio Interference Regulations of the Canadian Department of Communications.

**This class B digital apparatus complies with Canadian ICES-003.**

# Safety information

## Electrical safety

- To prevent electrical shock hazard, disconnect the power cable from the electrical outlet before relocating the system.
- When adding or removing devices to or from the system, ensure that the power cables for the devices are unplugged before the signal cables are connected.
- If the power supply is broken, do not try to fix it by yourself. Contact a qualified service technician or your retailer.

## Operation safety

- Before installing devices into the system, carefully read all the documentation that came with the package.
- Before using the product, make sure all cables are correctly connected and the power cables are not damaged. If you detect any damage, contact your dealer immediately.
- To avoid short circuits, keep paper clips, screws, and staples away from connectors, slots, sockets and circuitry.
- Avoid dust, humidity, and temperature extremes. Do not place the product in any area where it may become wet. Place the product on a stable surface.
- If you encounter technical problems with the product, contact a qualified service technician or your retailer.

### *Lithium-Ion Battery Warning*

**CAUTION:** Danger of explosion if battery is incorrectly replaced. Replace only with the same or equivalent type recommended by the manufacturer. Dispose of used batteries according to the manufacturer's instructions.

**VORSICHT:** Explosionsgefahr bei unsachgemäßen Austausch der Batterie. Ersatz nur durch denselben oder einem vom Hersteller empfohlenem ähnlichen Typ. Entsorgung gebrauchter Batterien nach Angaben des Herstellers.

### *LASER PRODUCT WARNING*

**CLASS 1 LASER PRODUCT**

# About this guide

## Audience

This guide provides general information and installation instructions about the ASUS T2-AH1 barebone system. This guide is intended for experienced users and integrators with hardware knowledge of personal computers.

## How this guide is organized

This guide contains the following parts:

### 1. Chapter 1: System introduction

This chapter gives a general description of the ASUS T2-AH1. The chapter lists the system features, including introduction on the front and rear panel, and internal components.

### 2. Chapter 2: Basic installation

This chapter provides step-by-step instructions on how to install components in the system.

### 3. Chapter 3: Starting up

This chapter helps you power up the system and install drivers and utilities from the support CD.

### 4. Chapter 4: Motherboard information

This chapter gives information about the motherboard that comes with the system. This chapter includes the motherboard layout, jumper settings, and connector locations.

### 5. Chapter 5: BIOS information

This chapter tells how to change system settings through the BIOS Setup menus and describes the BIOS parameters.

### 6. Appendix

The Appendix includes the power supply unit specification for this system.



## Conventions used in this guide



**WARNING:** Information to prevent injury to yourself when trying to complete a task.



**CAUTION:** Information to prevent damage to the components when trying to complete a task.



**IMPORTANT:** Instructions that you **MUST** follow to complete a task.



**NOTE:** Tips and additional information to aid in completing a task.

## Where to find more information

Refer to the following sources for additional information and for product and software updates.

### 1. ASUS Websites

The ASUS websites worldwide provide updated information on ASUS hardware and software products. Refer to the ASUS contact information.

### 2. Optional Documentation

Your product package may include optional documentation, such as warranty flyers, that may have been added by your dealer. These documents are not part of the standard package.

# System package contents

Check your T2-AH1 system package for the following items.



If any of the items is damaged or missing, contact your retailer immediately.

Item description
<b>1. ASUS T2-AH1 barebone system with</b>
• ASUS motherboard
• 250 W PFC power supply unit
• Gigabit LAN port
• CPU fan and heatsink assembly
• 2 x 5.25" drive bays
• 1 x 3.5" floppy disk drive bay
• 1 x 3.5" hard disk drive bay
• 6 x USB 2.0 ports
• 2 x IEEE 1394a ports (6-pin and 4-pin)
• S/PDIF In port
• S/PDIF out port
• 7-in-1 storage card reader
• FM radio module and radio antenna
• LED panel
• Audio DJ play buttons
<b>2. Cables</b>
• AC power cable
• Serial ATA cable
• Serial ATA power cable
<b>3. Support CD</b>
<b>4. User guide</b>
<b>5. Optional items</b>
• Optical drive ( <i>CD-ROM/CD-RW/DVD-ROM/DVD-RW</i> )
• Floppy disk drive

# Chapter 1

This chapter gives a general description of the ASUS T2-AH1. The chapter lists the system features including introduction on the front and rear panel, and internal components.

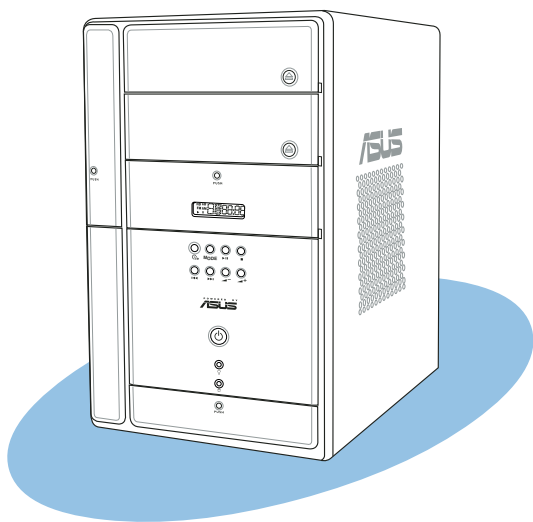

ASUS T2-AH1

## 1.1 Welcome!

Thank you for choosing the ASUS T2-AH1!

The ASUS T2-AH1 is an all-in-one barebone system with a versatile home entertainment feature.

The system comes in a stylish mini-tower casing, and powered by the ASUS motherboard that supports the AMD Athlon™ 64 processor for Socket 939 with 1 GHz/800 MHz/400 MHz FSB and up to 2 GB system memory.





With audio functions, extensive connectivity, and Gigabit LAN capability, the T2-AH1 is designed for the sophisticated.

With these and many more, the T2-AH1 definitely delivers the cutting edge technology for your computing and multimedia needs!

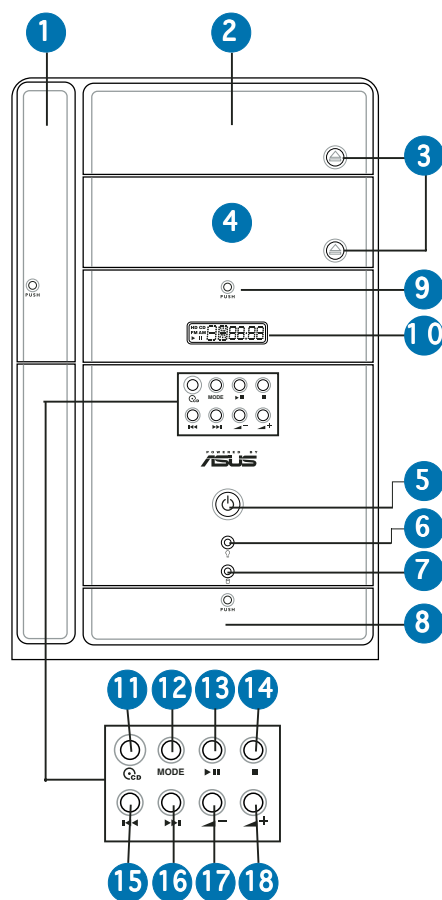
## 1.2 Front panel (external)

The front panel includes the system and audio control buttons, system LEDs, and LED panel.



1. **Floppy drive door.** Open this door to access the floppy disk drive.
2. **Optical drive door.** This door opens when you eject the loading tray.
3. **Eject button.** Press this button to eject the optical drive loading tray.
4. **Second optical drive door.** This door covers a second optical drive bay.
5. **Power button** . Press this button to turn the system on.
6. **Power LED** . This LED lights up to indicate that the system is ON.
7. **HDD LED** . This LED lights up when data is being read from or written to the hard disk drive
8. **Front panel I/O door.** Open this door to show the front panel input/output ports.
9. **Storage card reader door.** Open this door to access the 7-in-1 storage card reader.
10. **LED panel.** The LED panel displays the audio medium (CD/FM), radio frequency, player status (/i i), real time clock, track number, and time. See page 1-10 for details.



---

The following front panel buttons are activated only when the system is in **Audio DJ mode**. The Audio DJ feature allows you to play CD audio tracks, or tune in to an FM radio station without entering the operating system. See page 3-12 for details.

---

11. **CD button** . Press this button to put the Audio DJ function to CD mode.



---

In Windows® mode, pressing this button shuts down, restarts, or puts the system in sleep mode (S3) depending on the OS setting.

---

12. **Mode button.** Press this button to switch from CD to FM radio mode or vice versa.
13. **PLAY/PAUSE button** (/i i). Press this button to perform various functions in different modes.

In **CD mode**, plays or pauses an audio CD track.

In **Radio mode**, scans the available FM stations when pressed for less than two seconds or presets a station when pressed for more than two seconds. Refer to page 3-13 on how to preset a radio station.



14. **STOP button ■**. Press this button to stop the audio track being played.
15. **PREVIOUS button ◀◀**. Press this button to perform various functions in different modes.  
In **CD mode**, selects the previous audio track.  
In **Radio mode**, selects the previous preset station.
16. **NEXT button ▶▶**. Press this button to perform various functions in different modes.  
In **CD mode**, selects the next audio track.  
In **Radio mode**, selects the next preset station.
17. **Volume down button ◀-**. Press this button to decrease the system volume.
18. **Volume up button ▶+**. Press this button to increase the system volume.

## 1.3 Front panel (internal)

The optical drive(s), storage card reader slots, and several I/O ports are located inside the front panel doors.

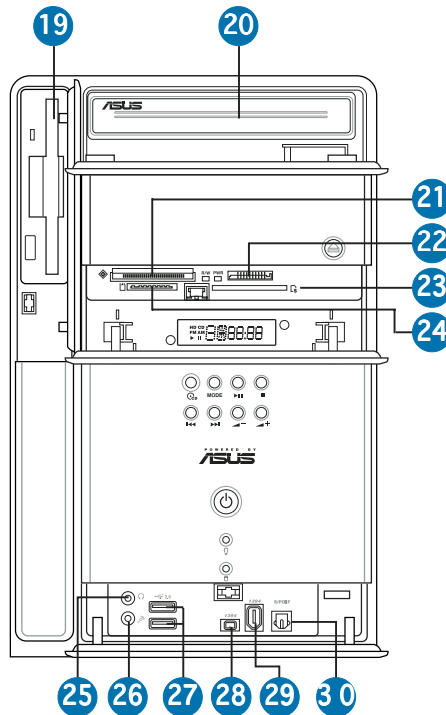



Open the front panel doors by pressing the  mark.



- 19. Floppy disk drive.** This drive is for a 1.44 MB, 3.5-inch floppy disk.
- 20. Optical drive (optional).** This is an IDE optical drive.
- 21. CompactFlash®/Microdrive™ card slot .** This slot is for a CompactFlash®/Microdrive™ storage card.
- 22. Memory Stick®/Memory Stick Pro™ card slot.** This slot is for a Memory Stick®/Memory Stick Pro™ storage card.
- 23. SmartMedia® card slot .** This slot is for a SmartMedia® storage card.
- 24. Secure Digital™/MultimediaCard slot .** This slot is for a Secure Digital™/MultimediaCard storage card.



- You cannot close the storage card reader door if a storage card is inserted into any of the card slots.
- Use and format a storage card according to the documentation that comes with it.







25. **Headphone port** . This port connects a headphone with a stereo mini-plug.
26. **Microphone port** . This Mic (pink) port connects a microphone.
27. **USB 2.0 ports** . These Universal Serial Bus 2.0 (USB 2.0) ports are available for connecting USB 2.0 devices such as a mouse, printer, scanner, camera, PDA, and others.
28. **4-pin IEEE 1394a port** . This port provides high-speed connectivity for IEEE 1394a-compliant audio/video devices, storage peripherals, and other PC devices.
29. **6-pin IEEE 1394a port** . This port provides high-speed connectivity for IEEE 1394a-compliant audio/video devices, storage peripherals, and other PC devices.
30. **Optical S/PDIF In port**. This port connects your audio system for 5.1-channel surround sound and enhanced 3D audio.

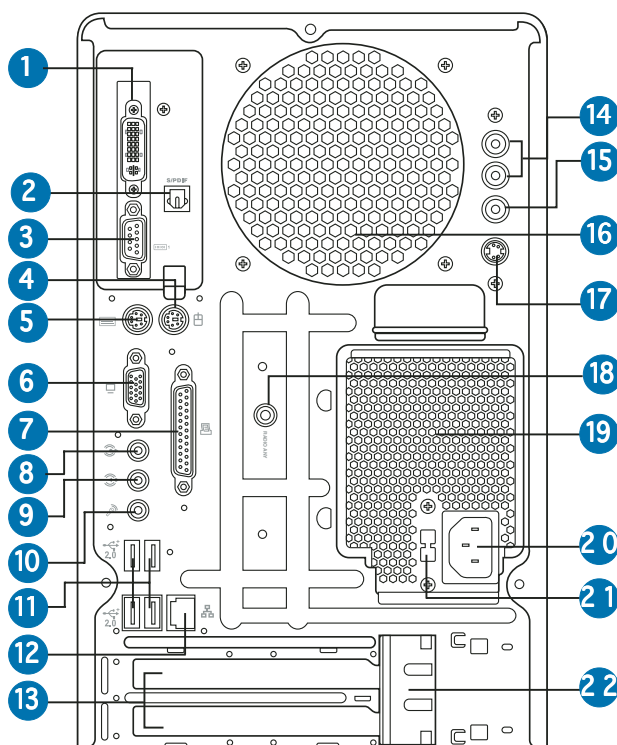

## 1.4 Rear panel

The system rear panel includes the power connector and several I/O ports that allow convenient connection of devices.



1. **DVI-out port.** This port connects a Digital Visual Interface (DVI) card.
2. **Optical S/PDIF Out port.** This port connects your audio system for 5.1-channel surround sound and enhanced 3D audio.
3. **Serial port** . This port connects a mouse, modem, or other devices that conforms with serial specification.
4. **PS/2 mouse port** . This green 6-pin connector is for a PS/2 mouse.
5. **PS/2 keyboard port** . This purple 6-pin connector is for a PS/2 keyboard.
6. **VGA port** . This port connects a VGA monitor.
7. **Parallel port** . This 25-pin port connects a printer, scanner, or other devices.
8. **Line Out port** . This Line Out (lime) port connects a headphone or a speaker. In 4/6-channel mode, the function of this port becomes Front Speaker Out.
9. **Line In port** . This Line In (light blue) port connects a tape player or other audio sources. In 4/6-channel mode, the function of this port becomes Surround output.

**10. Microphone port** . This Microphone (pink) port connects a microphone. In 6-channel mode, the function of this port becomes Low Frequency Enhanced output/Center.





The functions of the Line Out, Line In, and Microphone ports change when you select the 6-channel configuration. Refer to the table below for audio ports function variation.

## Audio ports function variation

Port	Headphone/2-Channel	4-Channel	6-Channel
Light Blue	Line In	Surround	Surround
Lime	Line Out	Front Speaker Out	Front Speaker Out
Pink	Mic In	Mic In	LFE Output*/Center

\* Low Frequency Enhanced Output

- 11. USB 2.0 ports**  **2.0**. These Universal Serial Bus 2.0 (USB 2.0) ports are available for connecting USB 2.0 devices such as a mouse, printer, scanner, camera, PDA, and others.
- 12. LAN (RJ-45) port** . This port allows Gigabit connection to a Local Area Network (LAN) through a network hub.
- 13. Expansion slot covers.** Remove these covers when installing expansion cards.
- 14. Audio Out ports** (red and white). These ports connect the left and right audio input cable jacks to the television or VCR left audio output port.
- 15. Video Out port** (yellow). This port connects a video cassette recorder (VCR).
- 16. Chassis fan vent.** This vent is for the fan that provides ventilation inside the system chassis.
- 17. S-Video port** (black). This port connects a television set with S-Video feature.
- 18. Radio antenna port.** This port connects a radio antenna.
- 19. Power supply unit fan vent.** This vent is for the PSU fan that provides ventilation inside the power supply unit.
- 20. Power connector.** This connector is for the power cable and plug.
- 21. Voltage selector.** This switch allows you to adjust the system input voltage according to the voltage supply in your area. See the “Voltage selector” section on page 2-25 before adjusting this switch.
- 22. Expansion card lock.** This lock secures installed expansion cards. See page 2-15 for details.

## 1.5 Internal components

The illustration below is the internal view of the system when you remove the top cover and the power supply unit. The installed components are labeled for your reference. Proceed to Chapter 2 for instructions on installing additional system components.

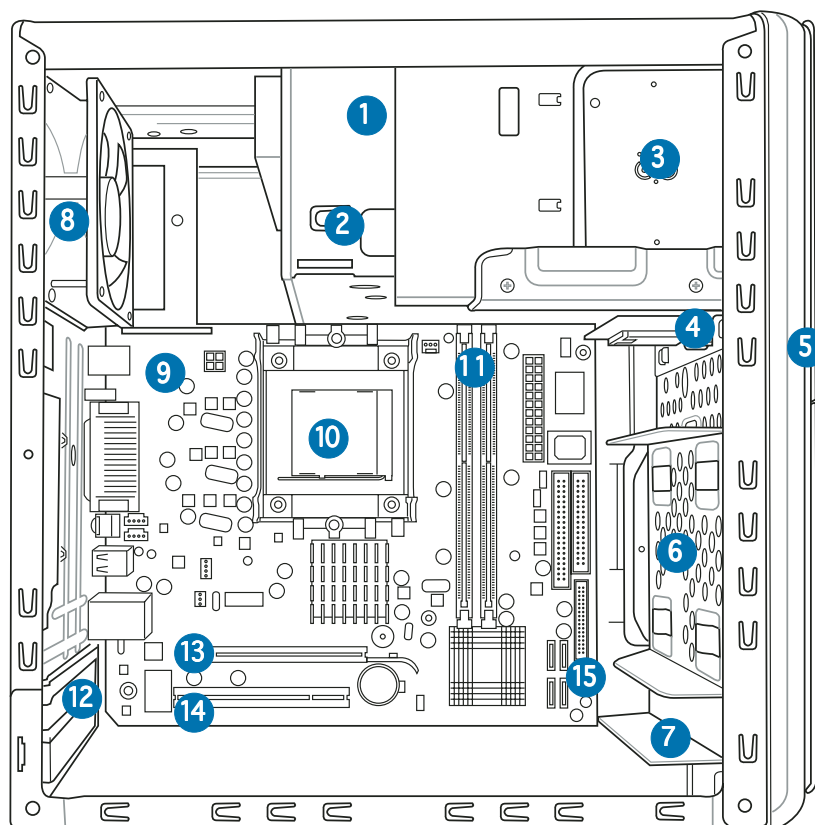

- |  |  |
|--|--|
| 1. Optical drive ( <i>optional</i> )     | 9. ASUS motherboard                                  |
| 2. 5.25-inch empty optical drive bay     | 10. CPU socket                                       |
| 3. Floppy disk drive ( <i>optional</i> ) | 11. DIMM sockets                                     |
| 4. Card reader module                    | 12. Expansion slots                                  |
| 5. Front panel cover                     | 13. PCI Express™ x16 slot for discrete graphics card |
| 6. Hard disk drive metal tray            | 14. PCI slot   |
| 7. Front panel I/O board                 | 15. Serial ATA connectors                            |
| 8. Chassis fan                           |  |

## 1.6 LED panel

The LED panel displays various system information depending on the system mode.

The LED panel displays the system time in 24-hour format when the system is in soft-off or stand-by mode, Suspend-to-RAM, Suspend-to-Disk, or Wait Boot state. Enter the BIOS setup or the operating system to adjust the time.



### Audio DJ mode

The LED panel displays various information when the system is in Audio DJ mode.

In **CD mode**, the LED panel displays the play/pause icon, number, and duration of the audio CD track being played.

CD mode, play/paused status



In **Radio mode**, the LED panel displays the station preset number and station frequency.

FM radio mode



---

Refer to page 3-11 for details on the Audio DJ feature.

---

# Chapter 2

This chapter provides step-by-step instructions on how to install components in the system.

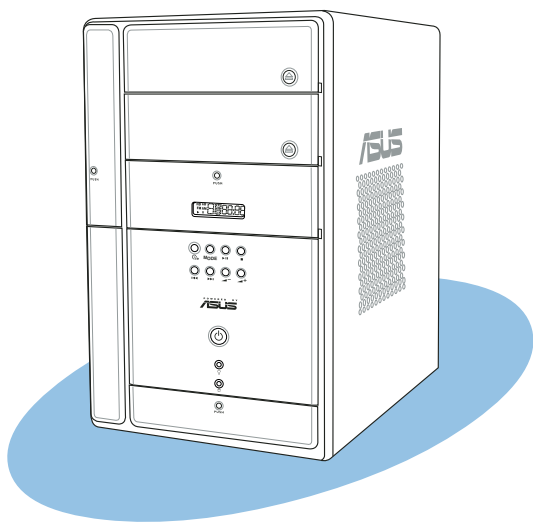

ASUS T2-AH1

## 2.1 Preparation

Before you proceed, make sure that you have all the components you plan to install in the system.

### Basic components to install

1. Central processing unit (CPU)
2. DDR Dual Inline Memory Module (DIMM)
3. Expansion card(s)
4. Hard disk drive
5. Optical drive
6. Floppy disk drive

### Tool

Phillips (cross) screw driver

## 2.2 Before you proceed

Take note of the following precautions before you install components into the system.



- Use a grounded wrist strap or touch a safely grounded object or a metal object, such as the power supply case, before handling components to avoid damaging them due to static electricity.
- Hold components by the edges to avoid touching the ICs on them.
- Whenever you uninstall any component, place it on a grounded antistatic pad or in the bag that came with the component.

The motherboard comes with an onboard standby power LED. This LED lights up to indicate that the system is ON, in sleep mode or in soft-off mode, and not powered OFF. Unplug the power cable from the power outlet and make sure that the standby power LED is OFF before installing any system component.

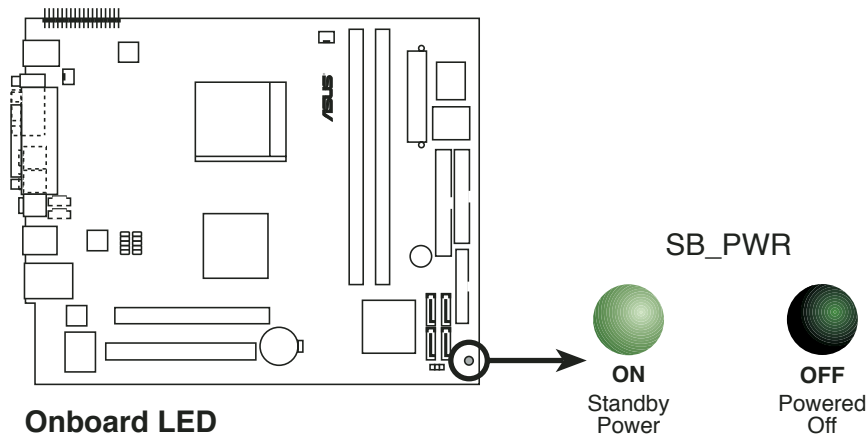

## 2.3 Removing the cover

To remove the cover:

1. On the rear panel, locate the three screws that secure the cover to the chassis.

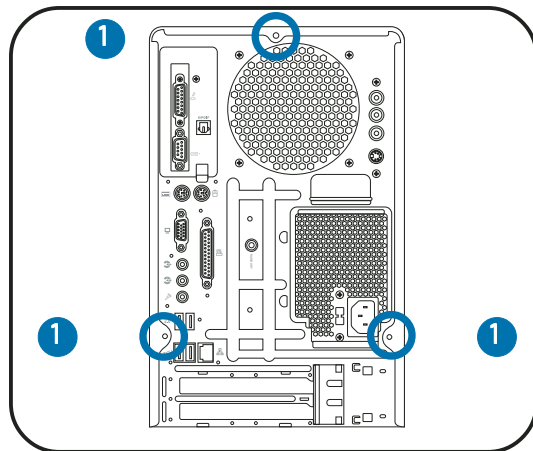

2. Use a Phillips screw driver to remove the cover screws. Keep the screws for later use.

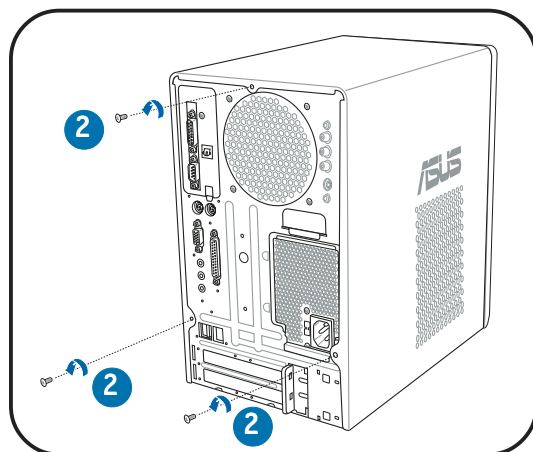

3. Slightly pull the cover toward the rear panel until the side tabs are disengaged from the chassis.
4. Lift the cover, then set aside.

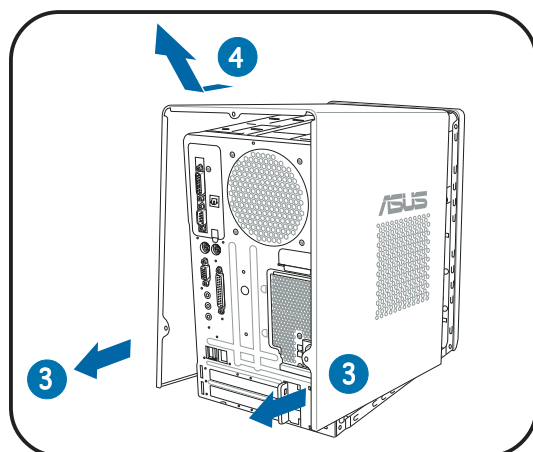

## 2.4 Removing the power supply

You must remove the power supply unit (PSU) before you can install a central processing unit (CPU) and other system components.

To remove the PSU:

1. Lay the system on its side on a flat, stable surface.
2. Disconnect the optical drive and floppy disk drive power plugs.
3. Remove the screw that secures the PSU to the chassis.

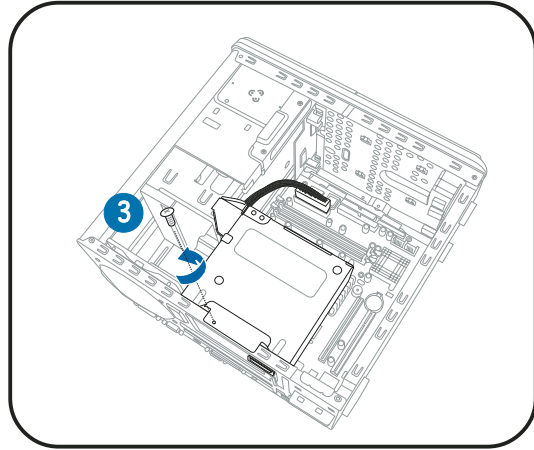

4. Slide the PSU as the zoomed image shows, until the side hook is disengaged from the chassis.
5. Push the PSU towards the front panel for about half an inch.
6. Slightly lift the PSU.

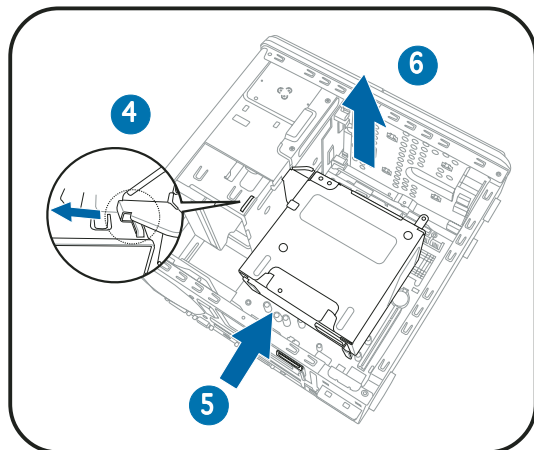

7. Disconnect the power plugs on the motherboard, then set the PSU aside.



When removing the PSU, make sure to hold or support it firmly. The unit may accidentally drop and damage other system components.

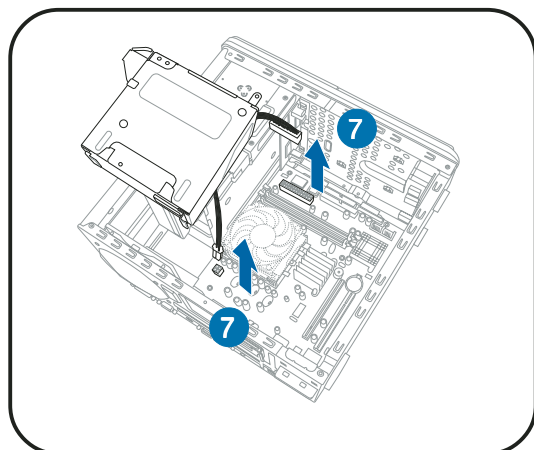



## 2.5 Installing a CPU

The motherboard comes with a surface mount 939-pin Zero Insertion Force (ZIF) socket designed for the AMD Athlon™ 64 processor.

The 128-bit-wide data paths of this processor can run applications faster than processors with only 32-bit or 64-bit wide data paths.

Take note of the marked corner (with gold triangle) on the CPU. This mark should match a specific corner on the socket to ensure correct installation.

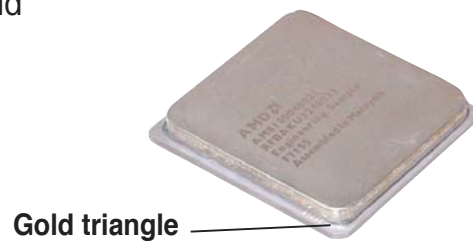

Gold triangle

### 2.5.1 CPU installation

To install a CPU:

1. Locate the CPU socket on the motherboard.

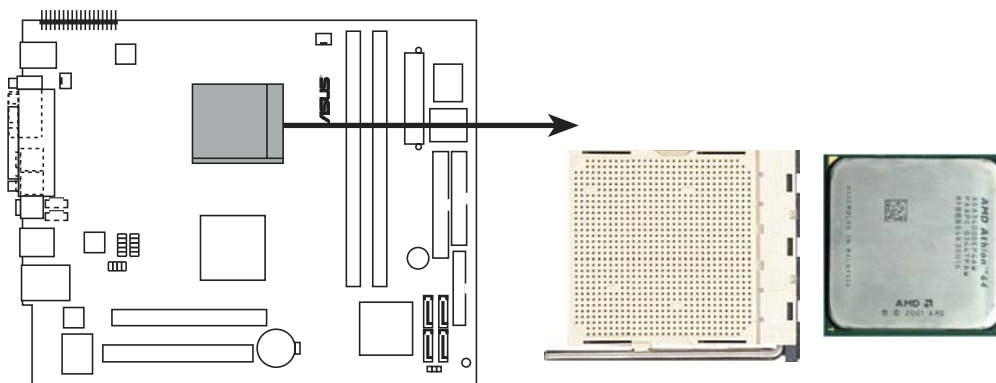

CPU Socket 939

2. Unlock the socket by pressing the lever sideways, then lift it up to a 90°-100° angle.



---

Make sure that the socket lever is lifted up to 90°-100° angle, otherwise the CPU does not fit in completely.

---

3. Position the CPU above the socket such that the CPU corner with the gold triangle matches the socket corner with a small triangle.
4. Carefully insert the CPU into the socket until it fits in place.



---

The CPU fits only in one correct orientation. DO NOT force the CPU into the socket to prevent bending the pins and damaging the CPU!

---

5. When the CPU is in place, push down the socket lever to secure the CPU. The lever clicks on the side tab to indicate that it is locked.

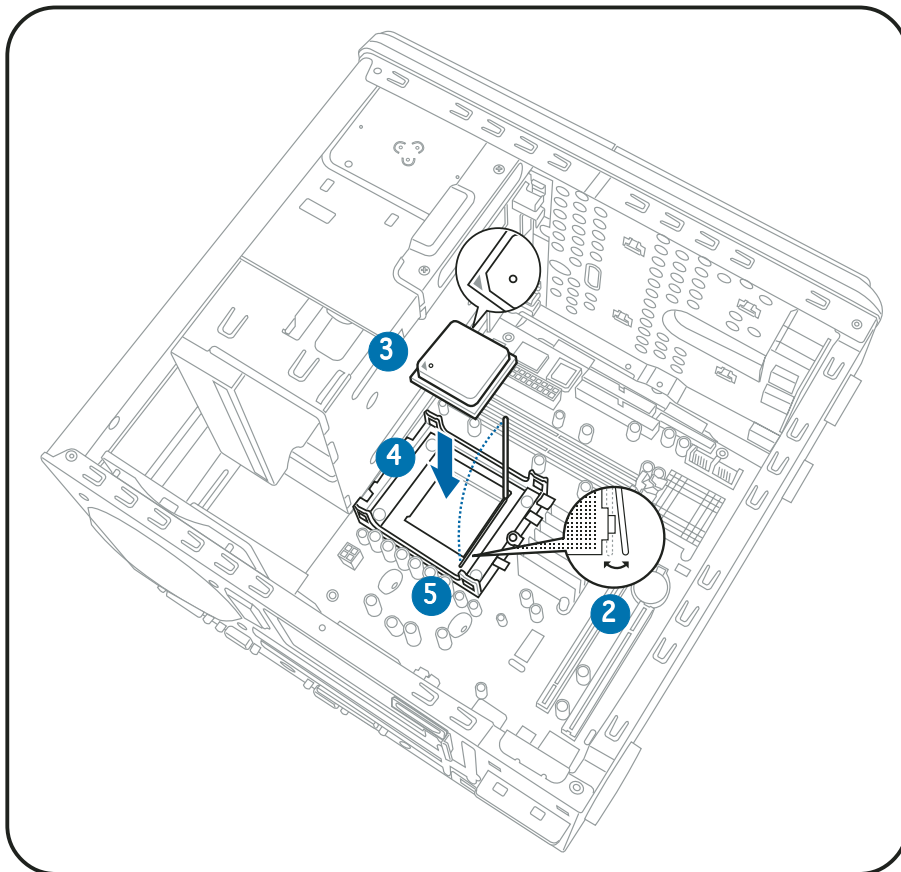

## 2.5.2 Installing the CPU fan and heatsink assembly



---

Make sure to turn off your computer and unplug the cable from the power source before installing the CPU fan and heatsink assembly.

---

To install the CPU fan and heatsink assembly:

1. Remove the CPU fan and heatsink assembly from its packaging and vacuum cover.



---

The CPU fan and heatsink assembly may be in the accessory box.

---

2. Place the CPU fan and heatsink assembly on top of the installed CPU, making sure it fits the retention module.
3. Connect the CPU fan cable to the CPU fan connector on the motherboard.
4. Align the metal clips to the side rail of the CPU fan and heatsink assembly, with the locking levers in the reverse orientation.
5. Snap the hook of each metal clip into the hole of the retention module.
6. Carefully press down each locking lever.
7. Hook its end into the retention module hole.



---

Do not forget to connect the CPU fan connector! Hardware monitoring errors may occur if you fail to plug this connector.

---

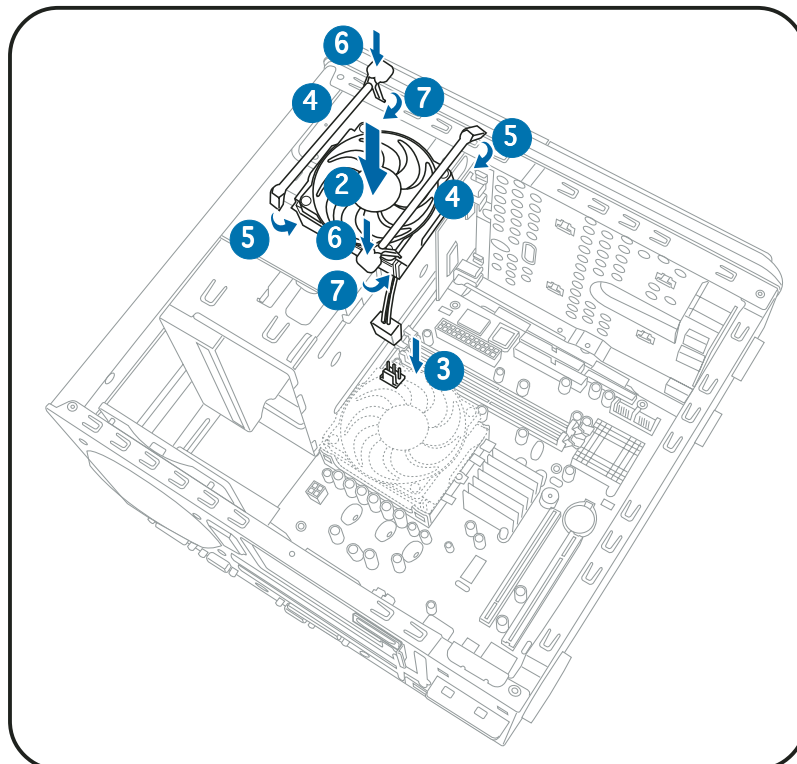

## 2.5.3 Removing the CPU fan and heatsink assembly



Make sure to turn off your computer and unplug the cable from the power source before removing the CPU fan and heatsink assembly.

To remove the CPU fan and heatsink assembly:

1. Disconnect the CPU fan cable from the CPU fan connector on the motherboard.
2. Carefully press down the locking lever.
3. Unhook the end of the locking lever from the retention module hole.
4. Slide out the metal clip to remove the hook of the other locking lever end from the retention module hole.
5. Lift the metal clip from the side rail of the CPU fan and heatsink assembly.
6. Repeat steps 2 ~ 5 to remove the other metal clip.
7. Carefully lift the CPU fan and heatsink assembly.

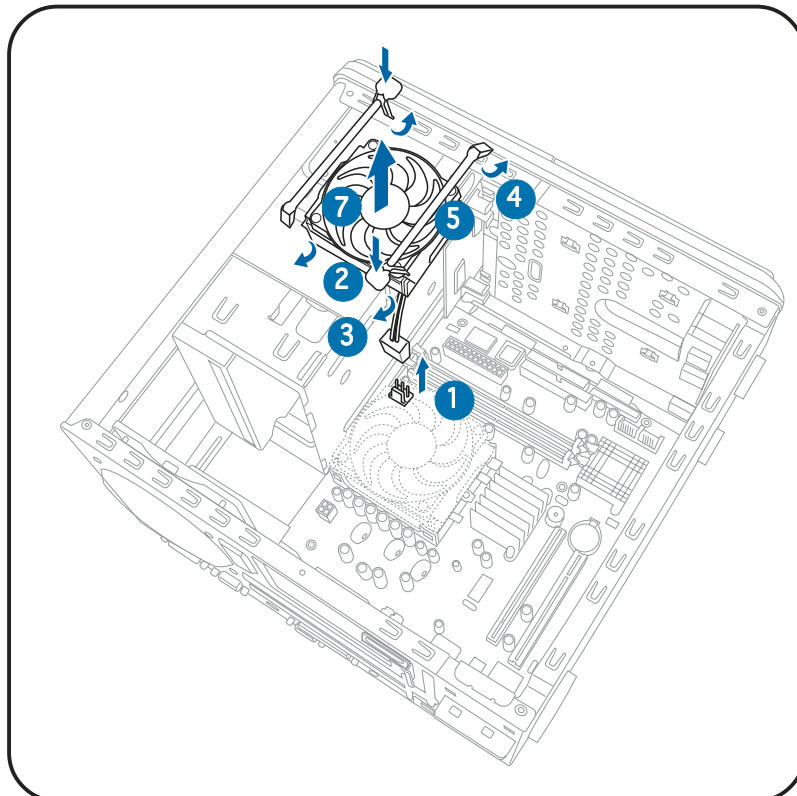

## 2.6 Installing a DIMM

The system motherboard comes with two Double Data Rate (DDR) Dual Inline Memory Module (DIMM) sockets.

The following figure illustrates the location of the sockets:

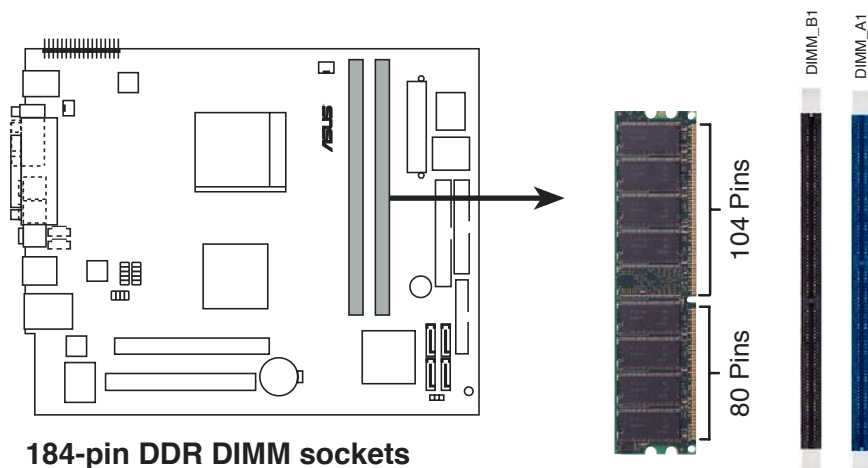

184-pin DDR DIMM sockets

### 2.6.1 Memory configurations

You may install up to 2 GB system memory using 256 MB, 512 MB, and 1 GB DDR DIMMs.



- Installing DDR DIMMs other than the recommended configurations may cause memory sizing error or system boot failure. Use any of the recommended configurations in the table on the next page.
- Install only **identical** (the same type and size) DDR DIMM in DIMM\_A1 and DIMM\_B1.
- If installing only one DDR DIMM, install it in DIMM\_A1 (blue slot).
- Always install DIMMs with the same CAS latency. For optimum compatibility, we recommend that you obtain memory modules from the same vendor.
- Due to chipset resource allocation, the system may detect less than your total system memory size when you enable the onboard VGA.
- This motherboard does not support memory modules made up of 128 Mb chips or double-sided x16 memory modules.

## Recommended memory configurations

Mode	Sockets	
	DIMM_A1 (blue)	DIMM_B1 (black)
Single-channel	(1) Installed	—
Dual-channel	(2)* Installed	Installed

\* Use only identical DDR DIMM pairs.

## DDR (400 MHz) Qualified Vendors List

Size	Vendor	Model	Brand	Side/s*	Component	CL	DIMM support		
							A	B	
256 MB	KINGSTON	KVR400X72C3A/256	Mosel	SS	V58C2256804SAT5(ECC)	-	•	•	
512 MB	KINGSTON	KVR400X72C3A/512	Mosel	DS	V58C2256804SAT5(ECC)	-	•	•	
512 MB	KINGSTON	KHX3200A/512	-	DS	-	-	•	•	
1024 MB	KINGSTON	KHX3200ULK2/1G	-	DS	-	2	•	•	
256 MB	KINGSTON	KVR400X64C3A/256	-	SS	D3208DL3T-5A	-	•	•	
256 MB	KINGSTON	KVR400X64C3A/256	-	SS	A2S56D30BTP511ALM09	-	•	•	
512 MB	KINGSTON	KVR400X64C3A/512	-	DS	V58C2256804SAT5	-	•	•	
512 MB	KINGSTON	KVR400X64C3A/512	-	SS	HY5DU12822BT-D43	-	•	•	
1024 MB	KINGSTON	KVR400X64C3A/1G	-	DS	HYB25D512800BE-5B	-	•	•	
256 MB	SAMSUNG	M381L3223ETM-CCC	SAMSUNG	SS	K4H560838E-TCCC(ECC)	3ECC	•	•	
512 MB	SAMSUNG	M381L6423ETM-CCC	SAMSUNG	DS	K4H560838E-TCCC(ECC)	-	•	•	
256 MB	SAMSUNG	M368L3223ETM-CCC	SAMSUNG	SS	K4H560838E-TCCC	-	•	•	
256 MB	SAMSUNG	M368L3223FTN-CCC	SAMSUNG	SS	K4H560838F-TCCC	3	•	•	
512 MB	SAMSUNG	M368L6423FTN-CCC	SAMSUNG	DS	K4H560838F-TCCC	3	•	•	
512 MB	SAMSUNG	M368L6523BTM-CCC	SAMSUNG	SS	K4H510838B-TCCC	3	•	•	
256 MB	MICRON	MT8VDDT3264AG-40BCB	MICRON	SS	MT46V32M8TG-5BC	-	•	•	
512 MB	MICRON	MT16VDDT6464AG-40BCB	MICRON	DS	MT46V32M8TG-5BC	-	•	•	
256 MB	Infineon	HYS64D32300HU-5-C	Infineon	SS	HYB25D256800CE-5C	3	•	•	
512 MB	Infineon	HYS64D64320HU-5-C	Infineon	DS	HYB25D256800CE-5C	-	•	•	
256 MB	Infineon	HYS64D32301HU-5-C	Infineon	SS	HYB25D512160CE-5C	3	•	•	
512 MB	Infineon	HYS64D64300HU-5-C	Infineon	SS	HYB25D512800CE-5C	3	•	•	
1024 MB	Infineon	HYS64D128320HU-5-C	Infineon	DS	HYB25D512800CE-5B	3	•	•	
256 MB	CORSAIR	CMX256A-3200C2PT	Winbond	SS	W942508BH-5	2	•	•	
512 MB	CORSAIR	CMX512-3200C2	Winbond	DS	-	2	•	•	
512 MB	CORSAIR	VS512MB400	VALUE seLecT	DS	VS32M8-5	2.5	•	•	
1024 MB	CORSAIR	TWINX2048-3200C2	-	DS	-	3	•	•	
256 MB	Hynix	HYMD232646D8J-D43	Hynix	SS	HY5DU56822DT-D43	3	•	•	
512 MB	Hynix	HYMD264646D8J-D43	Hynix	DS	HY5DU56822DT-D43	3	•	•	

(Continued on the next page)

							DIMM support		
Size	Vendor	Model	Brand	Side/s*	Component	CL	A	B	
256 MB	TwinMOS	M2G9I08AIATT9F081AADT	TwinMOS	SS	TMD7608F8E50D	2.5	•	•	
512 MB	TwinMOS	M2G9J16AJATT9F081AADT	TwinMOS	DS	TMD7608F8E50D	2.5	•	•	
256 MB	TwinMOS	M2G9I08A8ATT9F081AADT	TwinMOS	SS	TMD7608F8E50D	2.5	•	•	
512 MB	TwinMOS	M2G9J16A8ATT9F081AADT	TwinMOS	DS	TMD7608F8E50D	2.5	•	•	
256 MB	Transcend	TS32MLD64V4F3	SAMSUNG	SS	K4H560838F-TCCC	3	•	•	
512 MB	Transcend	TS64MLD64V4F3	SAMSUNG	DS	K4H560838F-TCCC	3	•	•	
1024 MB	Transcend	TS128MLD64V4J	SAMSUNG	DS	K4H510838B-TCCC	3	•	•	
256 MB	Apacer	77.10636.33G	Infineon	SS	HYB25D256800CE-5C	3	•	•	
512 MB	Apacer	77.10736.33G	Infineon	DS	HYB25D256800CE-5C	3	•	•	
256 MB	Apacer	77.10639.60G	ProMOS	SS	V58C2256804SCT5B	2.5	•	•	
512 MB	Apacer	77.10739.60G	ProMOS	DS	V58C2256804SCT5B	2.5	•	•	
256 MB	A DATA	MDOSS6F3G31Y0K1E0Z	SAMSUNG	SS	K4H560838E-TCCC	3	•	•	
512 MB	A DATA	MDOSS6F3H41Y0N1E0Z	SAMSUNG	DS	K4H560838F-TCCC	3	•	•	
256 MB	A DATA	MDOHY6F3G31Y0N1E0Z	Hynix	SS	HY5DU56822CT-D43	3	•	•	
512 MB	A DATA	MDOHY6F3H41Y0N1E0Z	Hynix	DS	HY5DU56822CT-D43	3	•	•	
256 MB	A DATA	MDOAD5F3G31Y0D1E02	-	SS	ADD8608A8A-5B	2.5	•	•	
512 MB	A DATA	MDOAD5F3H41Y0D1E02	-	DS	ADD8608A8A-5B	2.5	•	•	
256 MB	Winbond	W9425GCDB-5	Winbond	SS	W942508CH-5	3	•	•	
512 MB	Winbond	W9451GCDB-5	Winbond	DS	W942508CH-5	-	•	•	
256 MB	PSC	AL5D8B53T-5B1K	PSC	SS	A2S56D30BTP	2.5	•	•	
512 MB	PSC	AL6D8B53T-5B1K	PSC	DS	A2S56D30BTP	2.5	•	•	
256 MB	KINGMAX	MPXB62D-38KT3R	-	SS	KDL388P4LA-50	-	•	•	
512 MB	KINGMAX	MPXC22D-38KT3R	-	DS	KDL388P4LA-50	-	•	•	
256 MB	NANYA	NT256D64S88COG-5T	-	SS	NT5DS32M8CT-5T	3	•	•	
512 MB	NANYA	NT512D64S8HCOG-5T	-	DS	NT5DS32M8CT-5T	3	•	•	
256 MB	NANYA	NT256D64SH4B0G-5T	-	SS	NT5DS32M16BT-5T	3	•	•	
512 MB	NANYA	NT512D64S88B0G-5T	-	DS	NT5DS64M8BT-5T	3	•	•	
1024 MB	NANYA	NT1GD64S8HB0G-5T	-	DS	NT5DS64M8BT-5T	-	•	•	
256 MB	CENTURY	DXV6S8SSCCE3K27E	SAMSUNG	SS	K4H560838E-TCCC	-	•	•	
512 MB	CENTURY	DXV2S8SSCCE3K27E	SAMSUNG	DS	K4H560838E-TCCC	-	•	•	
256 MB	CENTURY	DXV6S8EL5BM3T27C	-	SS	DD2508AMTA	-	•	•	
512 MB	CENTURY	DXV2S8EL5BM3T27C	-	DS	DD2508AMTA	-	•	•	
256 MB	CENTURY	DXV6S8EL5B	-	SS	DD2508AMTA	-	•	•	
256 MB	CENTURY	DXV6S8HXD43B	-	SS	HY5DU56822BT-D43	-	•	•	
256 MB	CENTURY	DXV6S8HXD43D	-	SS	HY5DU56822DT-D43	-	•	•	
512 MB	CENTURY	DXV2S8EL5B	-	DS	DD2508AMTA	-	•	•	
512 MB	CENTURY	DXV2S8HXD43B	-	DS	HY5DU56822BT-D43	-	•	•	
512 MB	CENTURY	DXV2S8HXD43D	-	DS	HY5DU56822DT-D43	-	•	•	
256 MB	CENTURY	DXV6S8EL5B/HP	-	SS	DD2508AKTA-5B-E	-	•	•	
512 MB	CENTURY	DXV2S8EL5B/HP	-	DS	DD2508AKTA-5B-E	-	•	•	
256 MB	CENTURY	DXV6S8MC5B	-	SS	MT46V32M8TG-5BG	-	•	•	

(Continued on the next page)

DIMM support								
Size	Vendor	Model	Brand	Side/s*	Component	C L	A	B
512 MB	CENTURY	DXV2S8MC5B	-	DS	MT46V32M8TG-5BG	-	•	•
256 MB	elixir	M2U25664DS88C3G-5T	elixir	SS	N2DS25680CT-5T	3	•	•
512 MB	elixir	M2U51264DS8HC1G-5T	elixir	DS	N2DS25680CT-5T	3	•	•
256 MB	Kreton	N/A	VT	SS	VT3225804T-5	-	•	•
512 MB	Kreton	N/A	VT	DS	VT3225804T-5	-	•	•
256 MB	Veritech	VU256FLTM25C	VT	SS	VT56DD32M8PC-5	3	•	•
512 MB	Veritech	VU512FLTM25C	VT	DS	VT56DD32M8PC-5	3	•	•
256 MB	Pmi	MD44256VIT3208GMHA01	MOSEL	SS	V58C2256804SAT5B	2.5	•	•
512 MB	Pmi	MD44512VIT3208GATA03	MOSEL	DS	V58C2256804SAT5B	2.5	•	•
256 MB	ProMOS	V826632K24SCTG-D0	-	SS	V58C2256804SCT5B	2.5	•	•
512 MB	ProMOS	V826664K24SCTG-D0	-	DS	V58C2256804SCT5B	2.5	•	•
256 MB	Deutron	AL5D8C53T-5B1T	PSC	SS	A2S56D30CTP	2.5	•	•
512 MB	Deutron	AL6D8C53T-5B1T	PSC	DS	A2S56D30CTP	2.5	•	•
256 MB	GEIL	GL5123200DC	-	SS	GL3LC32G88TG-35	-	•	•
512 MB	GEIL	GL1GB3200DC	-	DS	GL3LC32G88TG-35	-	•	•
256 MB	GEIL	GLX2563200UP	-	SS	GL3LC32G88TG-5A	-	•	•
256 MB	GEIL	GD3200-512DC	-	SS	WLCSP Package	-	•	•
256 MB	crucial	BL3264Z402.8TG	Ballistix	SS	-	2	•	•
512 MB	crucial	BL6464Z402.16TG	Ballistix	DS	-	2	•	•
256 MB	Novax	96M425653CE-40TB6	CEON	SS	C2S56D30TP-5	2.5	•	•
512 MB	Novax	96M451253CE-40TB6	CEON	DS	C2S56D30TP-5	2.5	•	•
256 MB	Aeneon	AED560UD00-500C88X	Aeneon	SS	AED83T500	3	•	•
256 MB	V-DATA	MDYVD6F4G2880B1E0H	-	SS	VDD9616A8A-5C	-	•	•

### Legend:

**A** - supports one module inserted into either slot, in a Single-channel memory configuration.

**B** - supports one pair of modules inserted into both slots as one pair of Dual-channel memory configuration.

**SS** - Single-sided

**DS** - Double-sided



Obtain DDR DIMMs only from ASUS qualified vendors. Refer to the Qualified DDR400 vendors list on this page. Visit the ASUS website ([www.asus.com](http://www.asus.com)) for the latest DDR Qualified Vendors List.



## 2.6.2 DIMM installation

To install a DDR DIMM:

1. Locate the two DIMM sockets on the motherboard.
2. Unlock a socket by pressing the retaining clips outward.
3. Align a DIMM on the socket such that the notch on the DIMM matches the break on the socket.
4. Firmly insert the DIMM into the socket until the retaining clips snap back in place and the DIMM is properly seated.

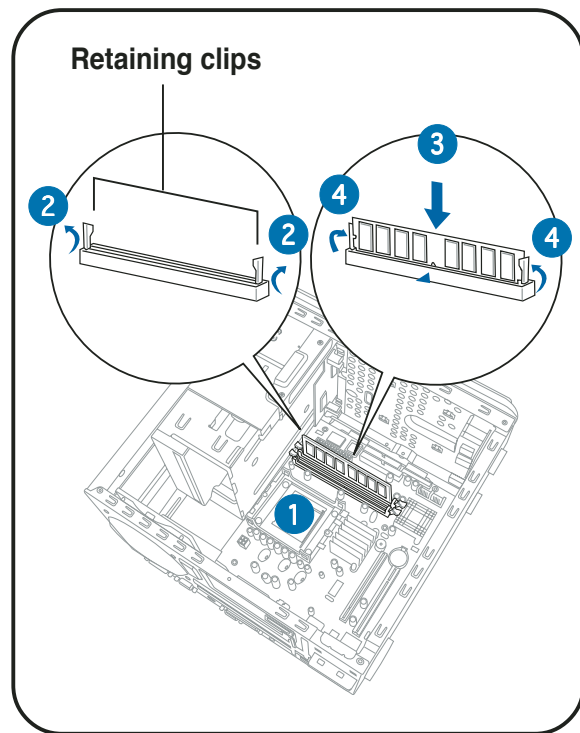

A DDR DIMM is keyed with a notch so that it fits in only one direction. **DO NOT** force a DIMM into a socket to avoid damaging the DIMM!

## 2.7 Installing an expansion card

In the future, you may need to install expansion cards. The motherboard has one PCI and one PCI Express™ x16 slot. The following sub-sections describe the slots and the expansion cards that they support.



---

Make sure to unplug the power cord before adding or removing expansion cards. Failure to do so may cause you physical injury and damage the motherboard.

---

### 2.7.1 Expansion slots

#### PCI slots

The PCI slots support PCI cards such as a LAN card, SCSI card, USB card, and other cards that comply with PCI specifications. The following figure shows a LAN card installed on a PCI slot.

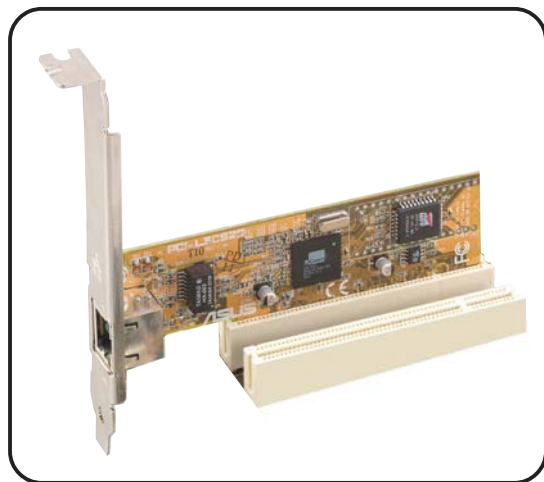

#### PCI Express™ x16 slot

This motherboard supports PCI Express™ x16 graphic cards that comply with PCI Express™ specifications. The figure shows a graphics card installed on the PCI Express™ x16 slot.

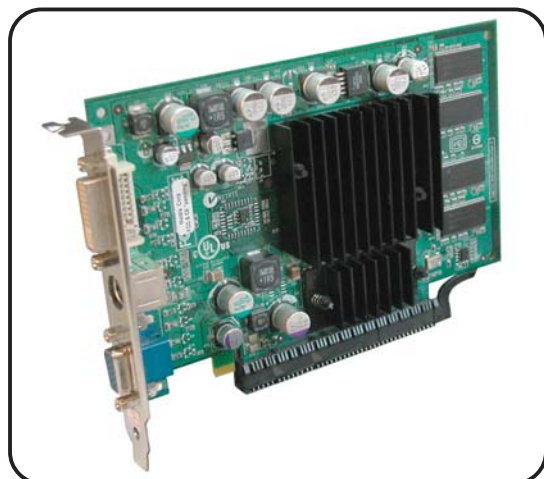

## 2.7.2 Expansion card installation

To install an expansion card.

1. Before installing the expansion card, read the documentation that came with it and make the necessary hardware settings for the card.
2. Pull the expansion card lock to the direction of the arrow.

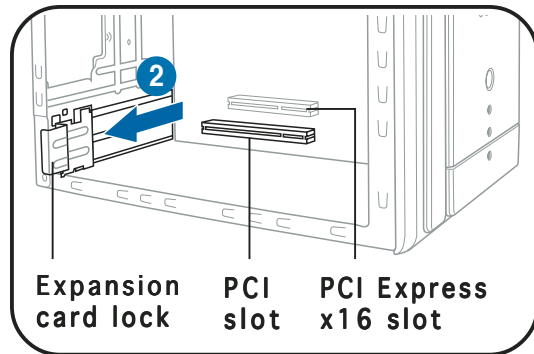

3. Remove the metal cover opposite the slot that you intend to use.

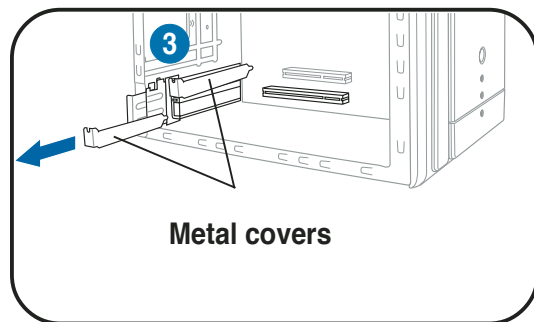

4. Align the card connector with the slot and press firmly until the card is completely seated on the slot.

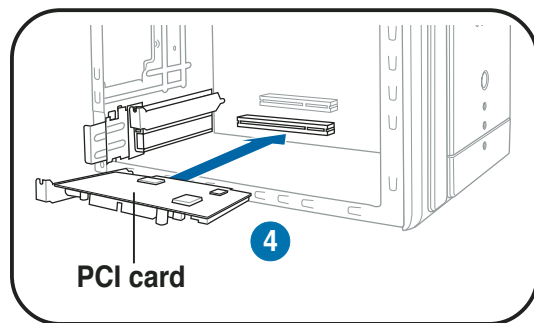

5. Replace the expansion card lock to secure the card to the chassis.

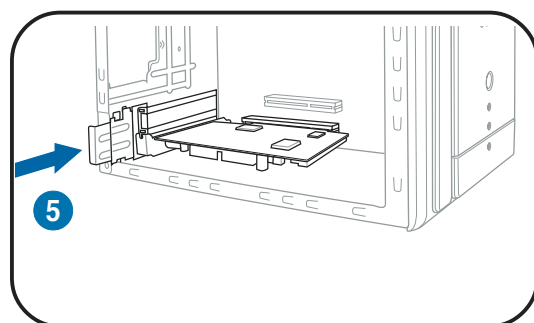

## Standard interrupt assignments

IRQ	Standard Function
0	System Timer
1	Keyboard Controller
2	Programmable Interrupt
4	Communications Port (COM1)
6	Floppy Disk Controller
7*	Printer Port (LPT1)
8	System CMOS/Real Time Clock
9*	ACPI Mode when used
10*	IRQ Holder for PCI Steering
11*	IRQ Holder for PCI Steering
12*	PS/2 Compatible Mouse Port
13	Numeric Data Processor
15*	Secondary IDE Channel

\* These IRQs are usually available for ISA or PCI devices.

## IRQ assignments for this motherboard

	A	B	C	D	E	F	G	H	P
USB0	--	shared	--	--	--	--	--	--	--
USB1	--	--	shared	--	--	--	--	--	--
USB2	--	--	--	used	--	--	--	--	--
USB3	--	--	--	--	--	--	--	--	used
AC '97	--	--	--	--	--	--	--	used	--
Onboard 1394	--	--	--	--	used	--	--	--	--
Onboard LAN	--	shared	--	--	--	--	--	--	--
Onboard PCIE	--	--	shared	--	--	--	--	--	--



When using a PCI card on shared slots, ensure that the drivers support “Share IRQ” or that the cards do not need IRQ assignments; otherwise, conflicts will arise between the two PCI groups, making the system unstable and the card inoperable.

## 2.8 Installing an optical drive

The barebone system comes with two 5.25-inch drive bays for two optical drives.



- You may install a second optical drive only if you installed a Serial ATA hard disk drive.
- Set your second optical drive as Slave device before connecting the IDE cable and power plug. Refer to the optical drive documentation on how to set the drive as a Slave device.

To install an optical drive:

1. Place the chassis upright.
2. Locate the front panel cover hooks.
3. To remove the front panel cover from the chassis, press the top hooks downward and the bottom hooks upward to release them from the metal tabs that secure them in place.
4. Detach the front panel cover top hooks.
5. Slightly push the front panel cover outward until it detaches from the chassis, then set it aside.

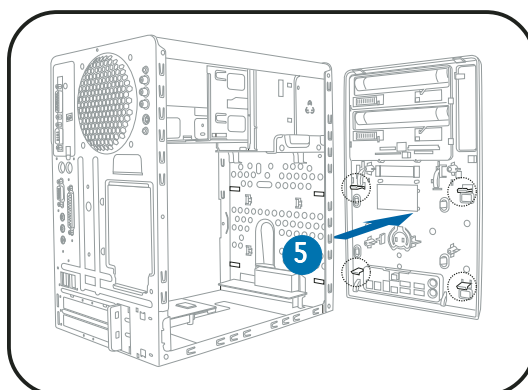
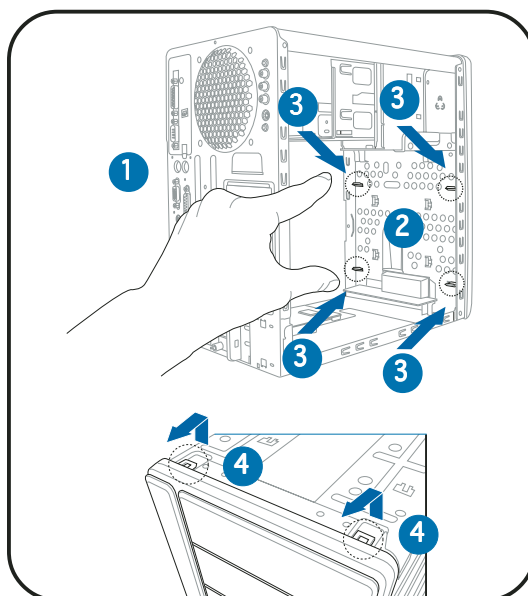

6. Carefully push the optical drive into the bay until its screw holes align with the holes on the bay as shown.
7. Secure the optical drive with two screws on one side of the bay.

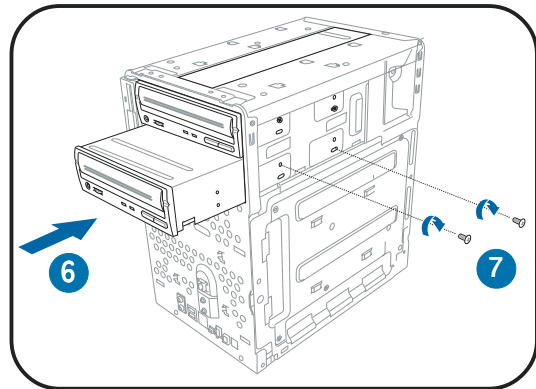

8. Connect a power cable from the power supply unit to the power connector at the back of the optical drive. See page 2-25 for details on the power supply unit plugs.
9. Connect the IDE ribbon cable to the IDE interface at the back of the optical drive, matching the red stripe on the cable with Pin 1 on the IDE interface.

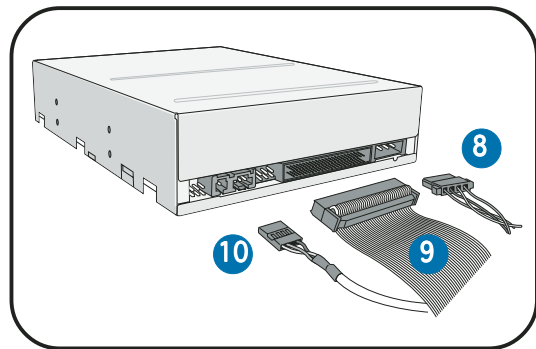

10. Connect one end of the optical drive audio cable to the 4-pin connector at the back of the optical drive.
11. Make sure that the other end of the IDE ribbon cable is connected to the IDE connector (blue connector labeled IDE) on the motherboard. See page 4-7 for the location of the IDE connector.
12. Connect the other end of the audio cable to the 4-pin CD connector on the motherboard. See page 4-7 for the location of the CD audio connector.

13. Reinstall the front panel cover by aligning its hooks with the chassis holes.

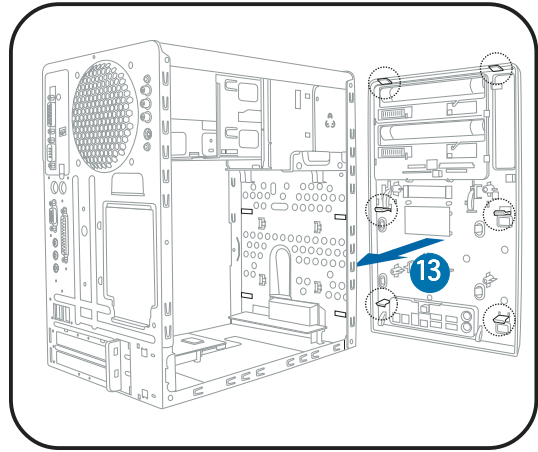

14. Lock the front panel cover hooks to the chassis holes as indicated.

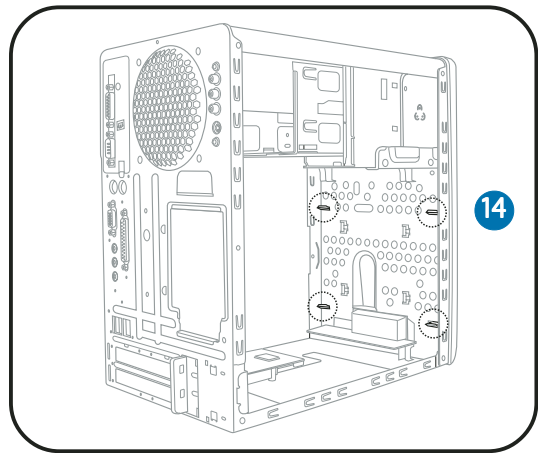

## 2.9 Installing a floppy disk drive

The barebone system comes with one 3.25-inch drive bay for a floppy disk drive.

To install a floppy disk drive:

1. Remove the front panel cover.



For instructions on how to remove the front panel cover, refer to steps 1-5 of section “2.8 Installing an optical drive.”

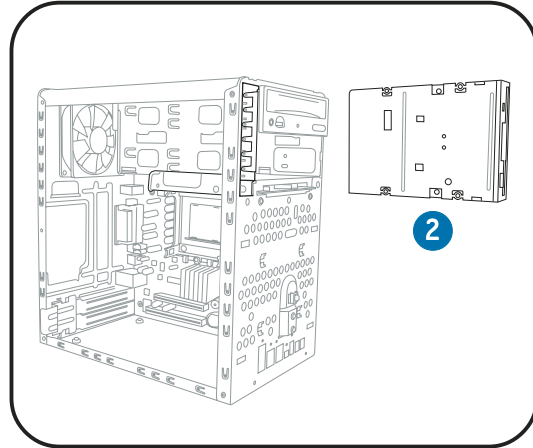

2. Carefully insert the floppy disk drive into the floppy drive bay until the screw holes align with the holes on the bay.

3. Secure the floppy disk drive with two screws.

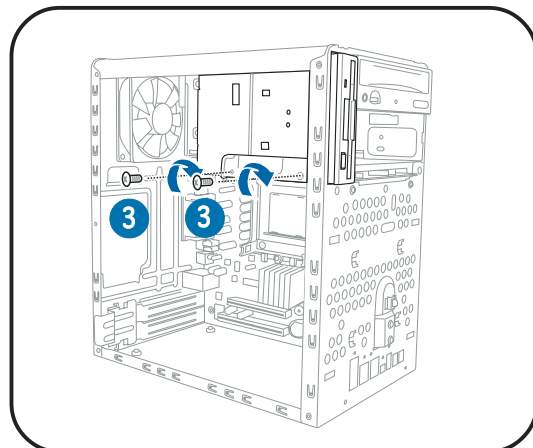

4. Connect the floppy disk drive signal cable to the signal connector at the back of the drive.

5. Connect the other end of the signal cable to the floppy disk drive connector (labeled FLOPPY) on the motherboard. See page 4-6 for the connector location.

6. Connect a power cable from the power supply unit to the power connector at the back of the floppy disk drive. See page 2-25 for details on the power supply unit plugs.

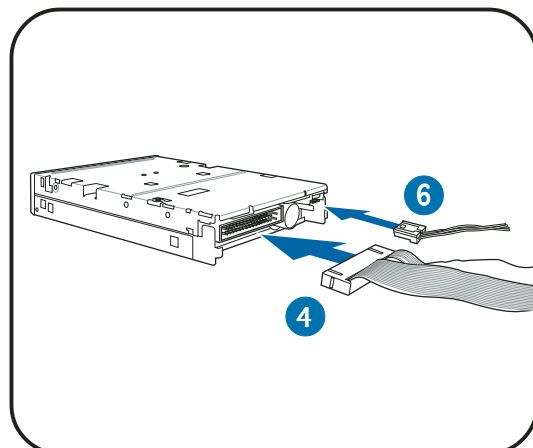



## 2.10 Installing a hard disk drive (HDD)

The system supports one Ultra ATA/133 IDE or one Serial ATA hard disk drive.

To install an IDE hard disk drive:

1. Locate the HDD tray lock screw on the other side of the chassis.
2. Remove the lock screw with a Philips screw driver. Keep the screw for later use.

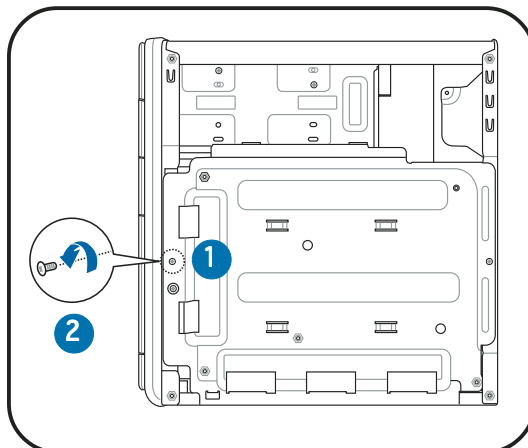

3. Slide the HDD tray outward until the tray slots are released from the chassis hooks.

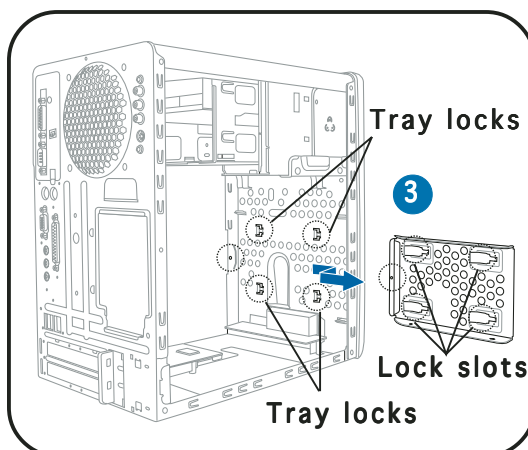

4. Place a hard disk drive on the tray with its bottom on the open side. Align the HDD and HDD tray screw holes.
5. Secure the HDD with four screws.

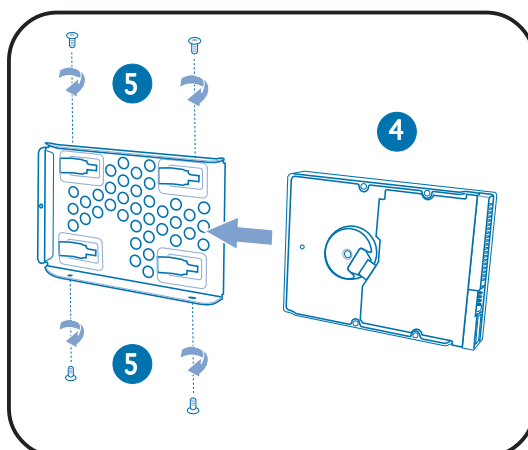

Configure your hard disk drive as Master device before connecting the IDE cable and power plug. Refer to the HDD documentation on how to set the drive as a Master device.

6. Reinstall the tray and the HDD to the chassis by locking the tray slots to the chassis hooks.
7. Secure the tray with the screw you removed earlier.

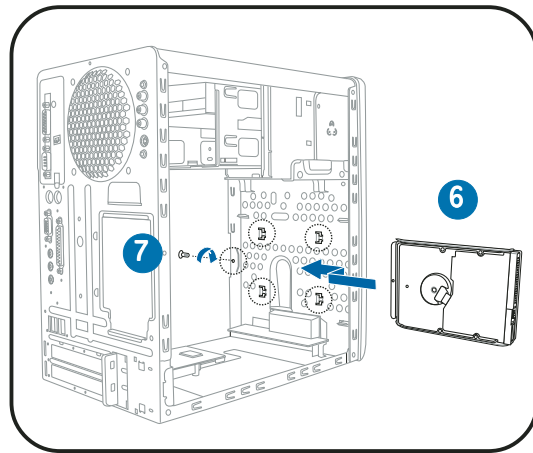

8. Connect one end of the 40-pin IDE cable to the IDE connector on the drive.
9. Connect a 4-pin power plug from the power supply unit to the HDD power connector. See page 2-25 for details on the power supply unit plugs.
10. Connect the other end of the IDE ribbon cable to the IDE connector (blue connector labeled IDE) on the motherboard. See page 4-7 for the location of the IDE connector.

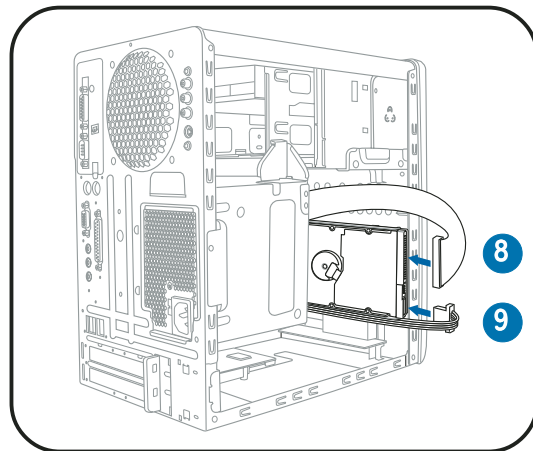

To install a Serial ATA hard disk drive:

1. Follow steps 1-7 of the previous section.
2. Connect one end of the supplied 7-pin SATA cable (right angle side) to the SATA connector at the back of the drive, then connect the other end to a SATA connector on the motherboard. See page 4-8 for the location of the Serial ATA connectors.

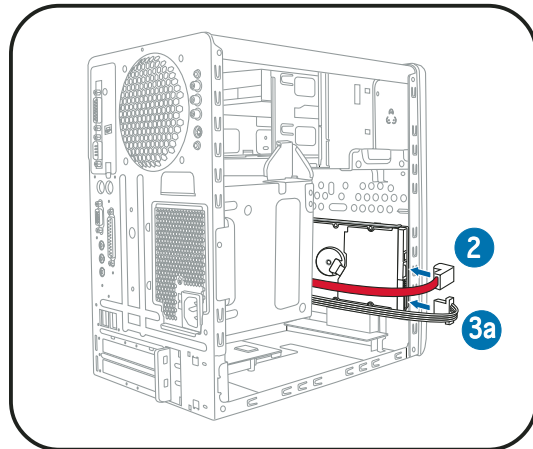

3. For Serial ATA HDDs with a 4-pin power connector:
  - a. Connect a 4-pin (female) power plug from the power supply unit to the 4-pin (male) power connector at the back of the drive. See page 2-25 for details on the power supply unit plugs.

For Serial ATA HDDs without a 4-pin power connector:

- b. Connect the 15-pin SATA power adapter plug to the power connector at the back of the drive, then connect the other end (4-pin male) to a 4-pin (female) power plug from the power supply unit. See page 2-25 for details on the power supply unit plugs.

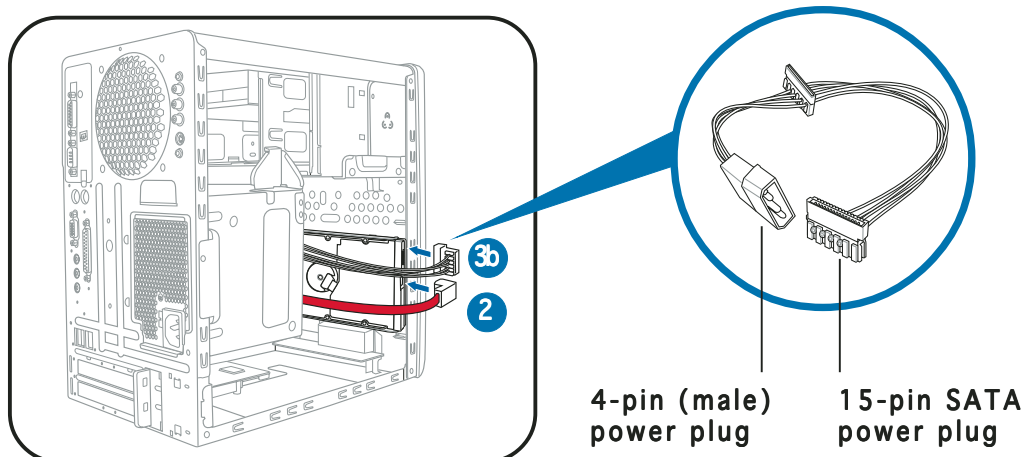

If your Serial ATA HDD has both 4-pin and 15-pin connectors at the back, use either the 15-pin SATA power adapter plug **OR** the legacy 4-pin power connector. **DO NOT** use both to prevent damage to components and to keep the system from becoming unstable.

## 2.11 Reinstalling the power supply unit

Reinstall the power supply unit (PSU) after installing the system components and reconnecting the cables, .

To reinstall the PSU:

1. Connect the 4-pin 12 V power plug to the ATX12V connector on the motherboard.
2. Connect the 24-pin ATX power plug to the ATXPWR connector on the motherboard. See page 4-6 for the location of power connectors.
3. Position the PSU over the chassis.
4. Align the PSU side hook with the metal slot located on the side of the optical drive bay.
5. Slide the PSU toward the direction of the rear panel until it fits in place.
6. Secure the PSU with the screw you removed earlier.

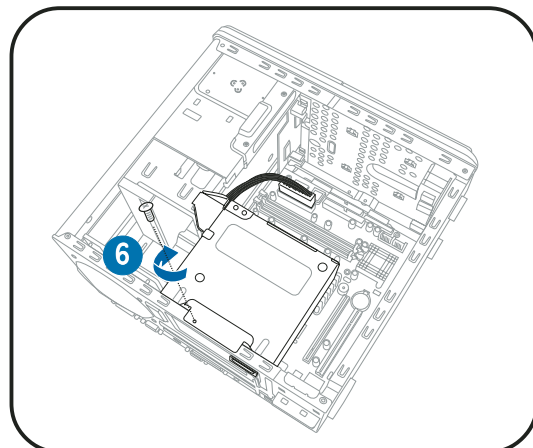
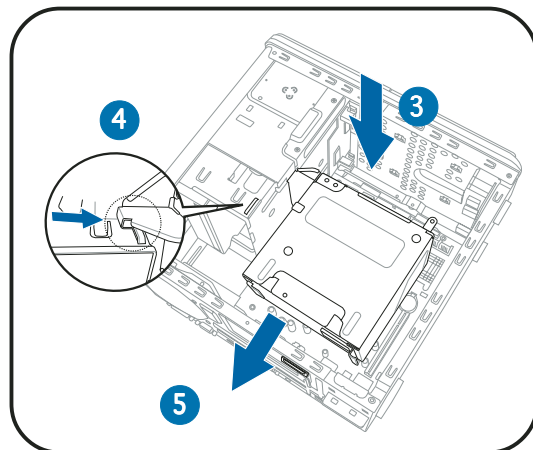
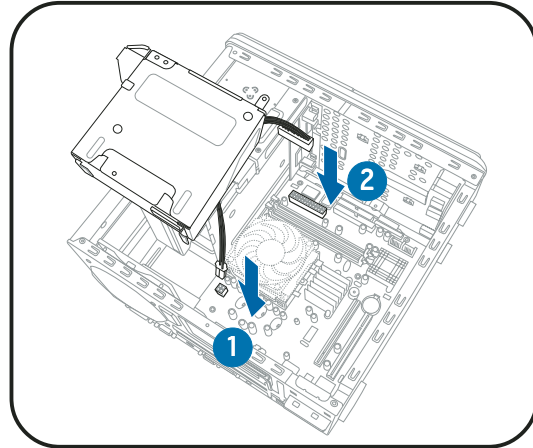

Make sure the PSU cables do not interfere with the CPU and/or chassis fans.

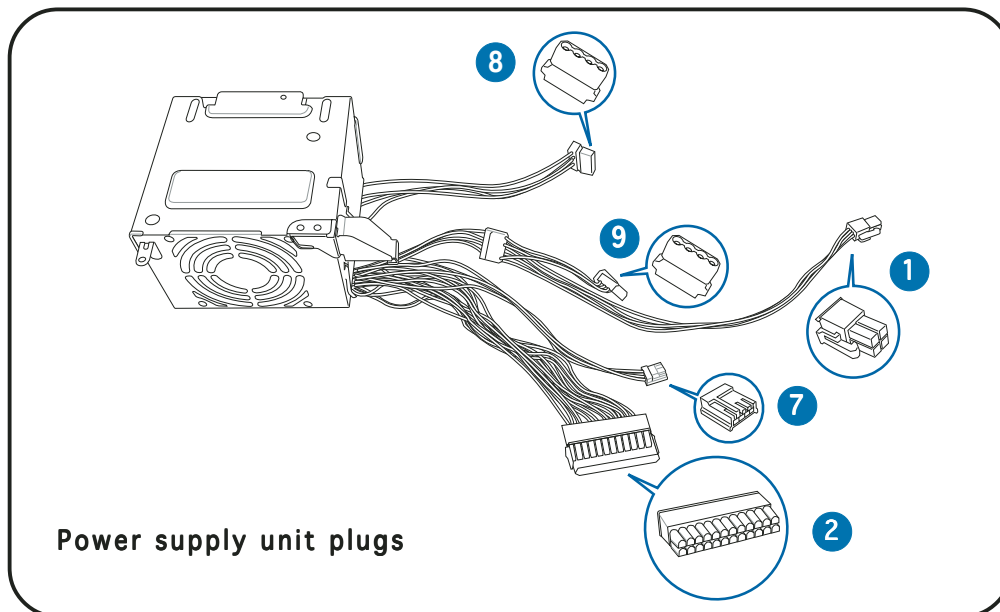

7. Connect the 4-pin power plug to the power connector of the floppy disk drive.
8. Connect the 4-pin power plug to the power connector of the IDE hard disk.
9. Connect the 4-pin power plug to the power connector of the optical drive.



---

See the Appendix for the power supply specifications.

---

## Voltage selector

The PSU has a 115 V/230 V voltage selector switch located beside the power connector. Use this switch to select the appropriate system input voltage according to the voltage supply in your area.

If the voltage supply in your area is 100-127 V, set the switch to 115 V.

If the voltage supply in your area is 200-240 V, set the switch to 230 V.

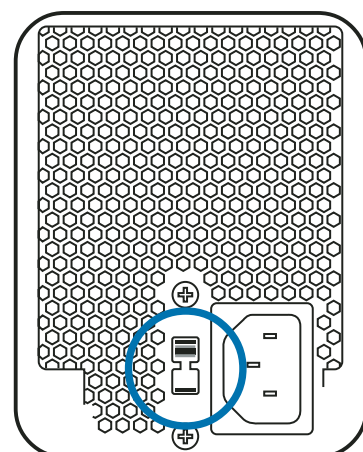

---

Setting the switch to 115 V in a 230 V environment will seriously damage the system!

---

## 2.12 Replacing the cover

To replace the cover:

1. Turn the chassis upright.
2. Position the front edge of the cover at least two inches from the front panel cover. Fit the cover tabs with the chassis rail and the front panel tabs.
3. Lower the rear edge of the cover as shown.
4. Push the cover slightly toward the front panel until it fits in place.
5. Secure the cover with the three screws you removed earlier.

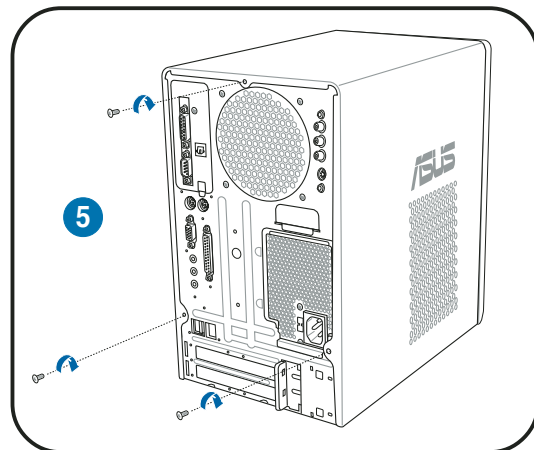
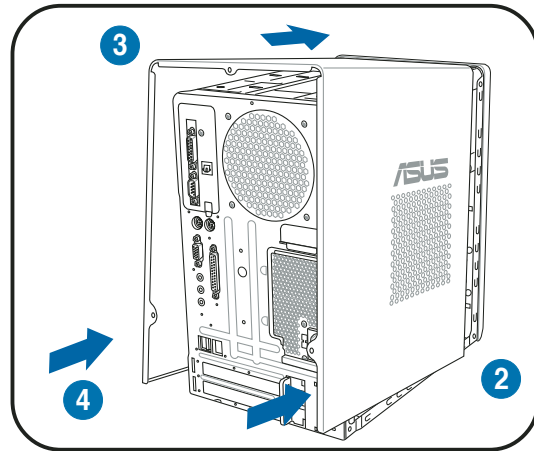

# Chapter 3

This chapter helps you power up the system and install drivers and utilities from the support CD.

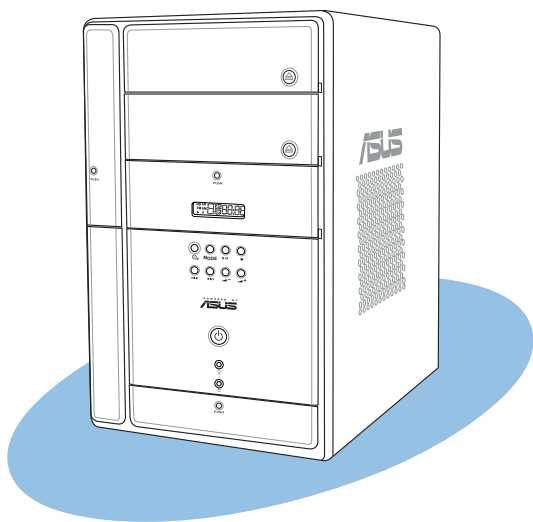

ASUS T2-AH1

# Starting up

## 3.1 Installing an operating system

The barebone system supports Windows® 2000/XP operating systems (OS). Always install the latest OS version and corresponding updates so you can maximize the features of your hardware.



---

Because motherboard settings and hardware options vary, use the setup procedures presented in this chapter for general reference only. Refer to your OS documentation for more information.

---

## 3.2 Powering up

The system has two power buttons located in the front panel. Press the system power button (⏻) to enter the OS. Press the  button to turn on the Audio DJ feature.

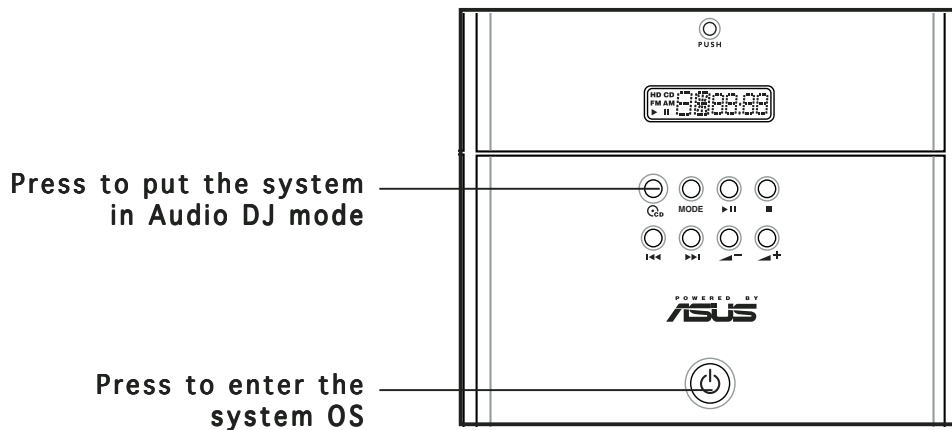

---

In Windows® mode, pressing the  button shuts down, restarts, or puts the system in sleep mode (S3) depending on the OS setting.

---

## 3.3 Support CD information

The support CD that came with the system contains useful software and several utility drivers that enhance the system features.



- Screen display and driver options may not be the same for other operating system versions.
  - The contents of the support CD are subject to change at any time without notice. Visit the ASUS website for updates.
-



### 3.3.1 Running the support CD

To begin using the support CD, place the CD in your optical drive. The CD automatically displays the **Drivers** menu if Autorun is enabled in your computer.

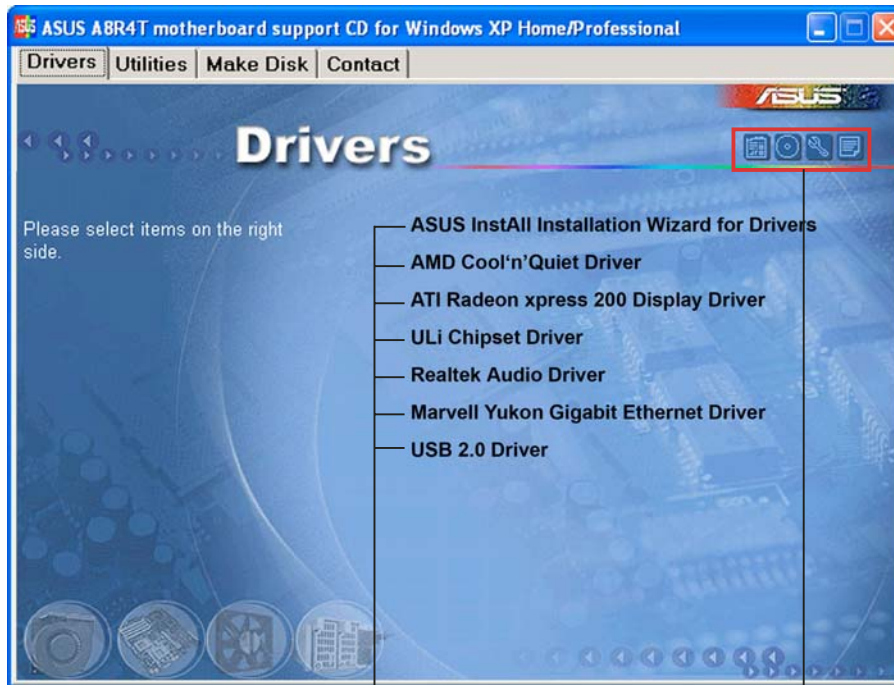

Click an item to install

Click an icon to display other information



If **Autorun** is NOT enabled in your computer, browse the contents of the support CD to locate the file **ASSETUP.EXE** from the BIN folder. Double-click the **ASSETUP.EXE** to run the CD.

### 3.3.2 Drivers menu

The drivers menu shows the available device drivers if the system detects installed devices. Install the necessary drivers to activate the devices.

#### **ASUS InstAll Installation Wizard for Drivers**

Launches the ASUS InstallAll driver installation wizard.

#### **AMD Cool 'n' Quiet Driver**

Launches the AMD Cool 'n' Quiet™ Technology driver installation wizard.

#### **ATI Radeon Xpress 200 Chipset Driver**

Installs the ATI Radeon Xpress 200 Chipset driver.

## ULi Chipset Driver

Installs the ULi Chipset driver.

## Realtek Audio Driver

Installs the Realtek® AC `97 audio driver and application. See page for details.

## Marvell Yukon Gigabit Ethernet Driver

Installs the Marvell® Gigabit Ethernet LAN Driver.

## USB 2.0 Driver

Installs the USB 2.0 driver.

### 3.3.3 Utilities menu

The Utilities menu shows the applications and other software that the motherboard supports.



### ASUS InstAll Installation Wizard for Utilities

Launches the ASUS InstallAll utilities installation wizard.

### Marvell Yukon VCT Application

Installs the Marvell Yukon Virtual Cable Tester (VCT) application. The VCT is a cable diagnostic application that analyzes and reports LAN cable faults and shorts.

## **ASUS PC Probe II**

This smart utility continuously monitors vital system information such as fan rotations, CPU temperature, and system voltages, and alerts you on any detected problems. This utility helps you keep your computer in a healthy operating condition.

## **ASUS Update**

Installs the ASUS Update that allows you to update the motherboard BIOS and drivers. This utility requires an Internet connection either through a network or an Internet Service Provider (ISP). See page 5-8 for details.

## **ASUS Screensaver**

Bring life to your idle screen by installing the ASUS Screensaver.

## **AMD Cool 'n' Quiet Utility**

Installs the AMD Cool 'n' Quiet™ Technology application.

## **ASUS Radio Player Utility**

Installs the ASUS Radio Player application.

## **Adobe Acrobat Reader V7.0**

The Acrobat® Acrobat Reader® software is for viewing files saved in Portable Document Format (PDF).

## **Microsoft DirectX 9.0c**

Installs Microsoft® DirectX® 9.0c. The Microsoft® DirectX® 9.0c is a multimedia technology that enhances computer graphics and sounds. DirectX® improves the multimedia features of your computer so you can enjoy watching TV and movies, capturing videos, or playing games on your computer.



---

This application is already built into the Microsoft® Windows® XP Service Pack 2. If Microsoft® Windows® XP Service Pack 2 is installed in your system, skip Microsoft® DirectX® 9.0c installation.

---

## **Anti-Virus Utility**

The anti-virus utility scans, identifies, and removes computer viruses. View the online help for detailed information.

### 3.3.4 Make Disk menu

The **Make Disk** menu allows you to create driver disks.



#### **Make ULi 32/64bit SATA Driver Disk**

Allows you to create a ULi Serial ATA driver disk for a 32/64-bit system.

### 3.3.5 ASUS contact information

The Contact tab displays the ASUS contact information.



### 3.3.6 Other information

The icons on the top right side of the screen provide additional information on the motherboard and the contents of the support CD.

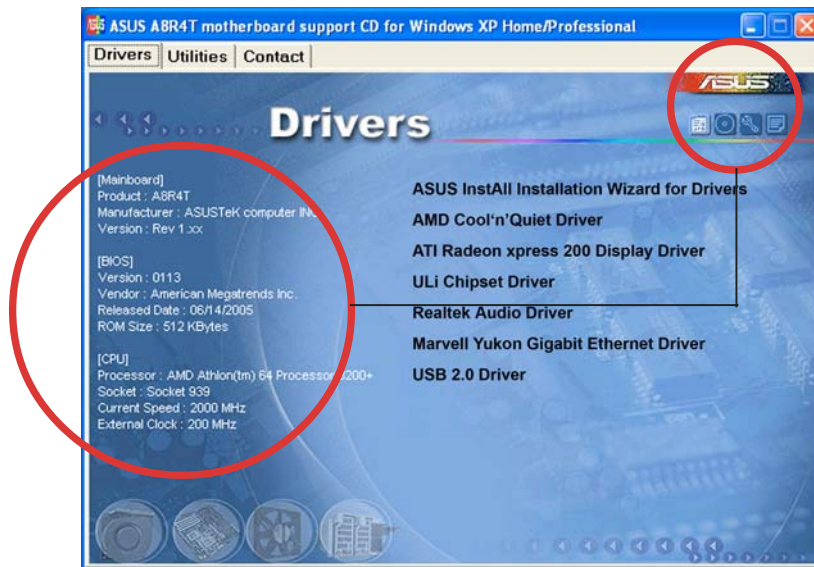

## 3.4 Software information

Most of the applications in the support CD have wizards that will conveniently guide you through the installation. View the online help or readme file that came with the software for more information.

### 3.4.1 ASUS Radio Player

ASUS Radio Player allows you to tune in to an FM station using the optional radio module.



By default, the radio region of the ASUS FM radio module is set to **Europe**. If you purchased the barebone system outside Europe (**USA** or **Japan**), you must change the radio region in the BIOS setup to receive FM radio signals. See section “5.4.1 Instant Music Configuration” for details.

### Launching the ASUS Radio Player

To launch the ASUS Radio Player:

1. Install the **ASUS Radio Application** from the **Utilities** tab of the support CD. See page 3-4 for details.
2. After installing the application, click **Start > All Programs > ASUS > ASUS Radio Player V1.0 > ASUS Radio Player V1.0** from the Windows® desktop.
3. The ASUS Radio Player panel appears.

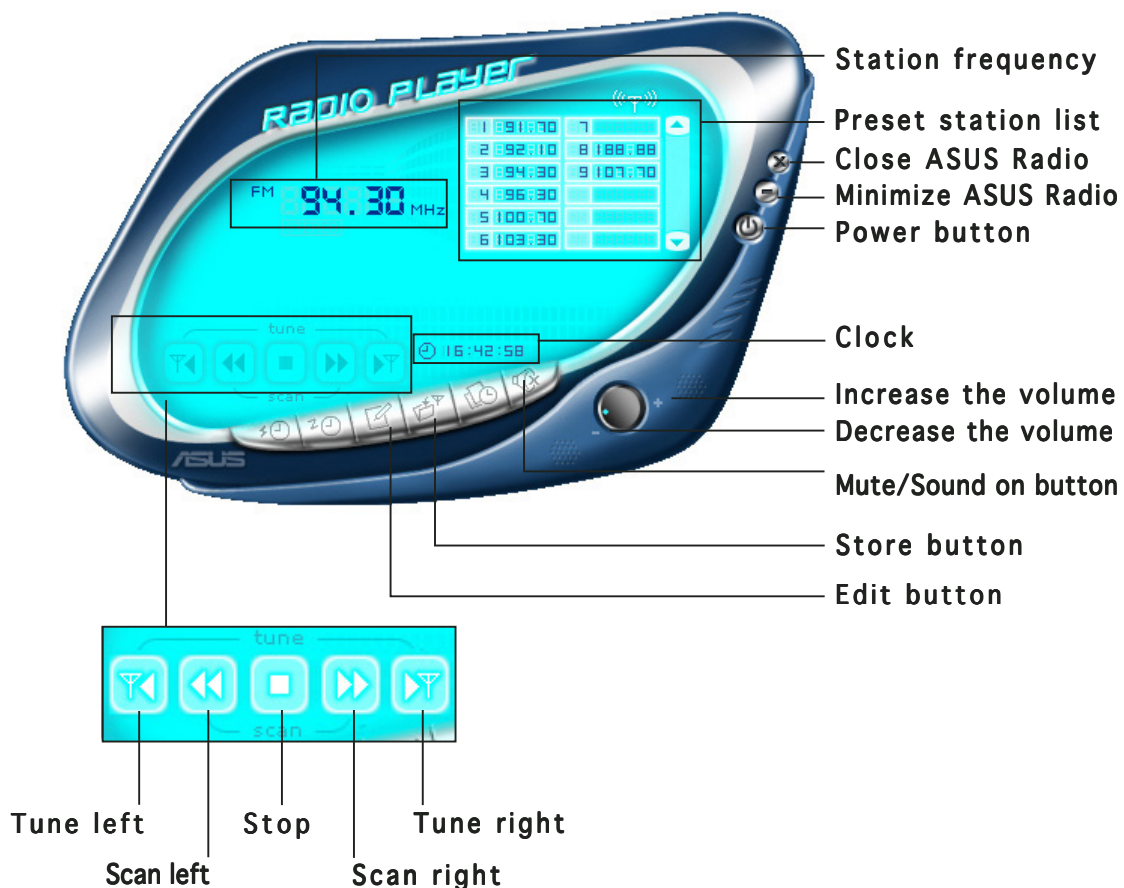

## Storing a radio station

To store a radio station:

1. Use the **Scan** or **Tune** buttons to tune into a radio station you wish to store.
2. Click the **Store** button. A **Store Channel** window appears.
3. Assign a **Channel** (preset number) to the radio station using the arrow buttons.
4. Type the station name in the field, then click **OK**.
5. The stored channel is displayed in the preset station list.



## Editing a stored radio

To edit a stored radio station:

1. Click the **Edit** button. An **Edit Channel** window appears.
2. Select a radio station you want to edit, then click the **Edit** button.
3. Another **Edit Channel** window appears.
4. Edit the station frequency and name.  
Click **OK** when you are done.

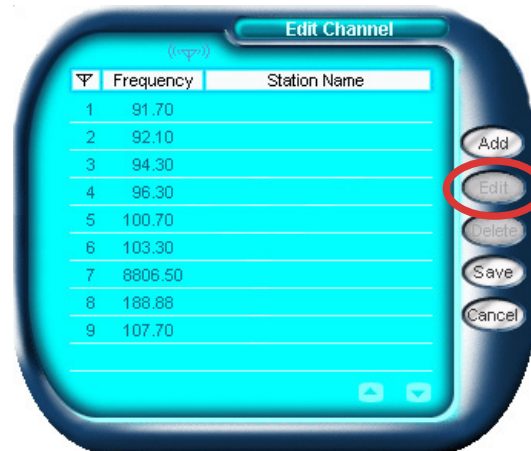

## 3.4.2 ASUS Instant Music

The motherboard is equipped with a BIOS-based audio playback feature called **Instant Music**. The onboard audio AC'97 CODEC supports this feature, which requires an optical drive (CD-ROM, DVD-ROM, or CD-RW).



- 
- Instant Music only supports CDs in audio format.
  - Instant Music does not work if you installed and enabled an add-on sound card.
  - Instant Music only supports PS/2 keyboard.
- 

### To enable ASUS Instant Music:

1. Connect the analog audio cable from the optical drive to the 4-pin CD connector on the motherboard. See section “4.4 Connectors” for the location of the CD connector.



---

Make sure to connect the optical drive audio cable. Otherwise, you cannot control the audio volume using the Instant Music function keys.

---

2. Turn on the system and enter BIOS by pressing the **Delete** key during the Power On Self-Tests (POST).
3. In the **Instant Music Configuration** menu, select the item **Instant Music** and set it to **Enabled**. See section “5.4.1 Instant Music Configuration.”
4. The **Instant Music CD-ROM Drive** item appears if you enabled Instant Music. Highlight the item then press <Enter> to display the CD-ROM options.
5. Save your changes and exit BIOS Setup.



- 
- The Scroll Lock LED is fixed to ON after enabling Instant Music.
  - The Caps Lock LED turns ON when you pause the CD playback.
  - When set to Instant Music mode, the system wake-up features (LAN, keyboard, mouse, USB) are deactivated. In this case, power up the system using the power switch.
  - If the system lost connection or did not detect any optical drive, the Instant Music feature turns OFF (disabled) automatically. A “beep” indicates this condition.
-



To use ASUS Instant Music:

1. Connect the PC power plug to an electrical outlet.
2. Use either one of the two sets of special function keys on your keyboard to play audio CDs. These keys only function as indicated if you enabled the Instant Music item in BIOS.

#### Instant Music function keys (Set 1)

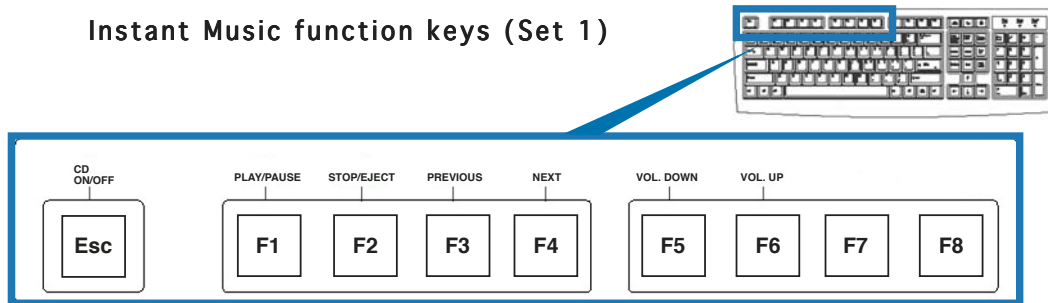

To guide you in using Instant Music, place the Instant Music label over the function keys on the keyboard. The Instant Music keyboard label comes with your motherboard package.

#### Instant Music function keys (Set 2)

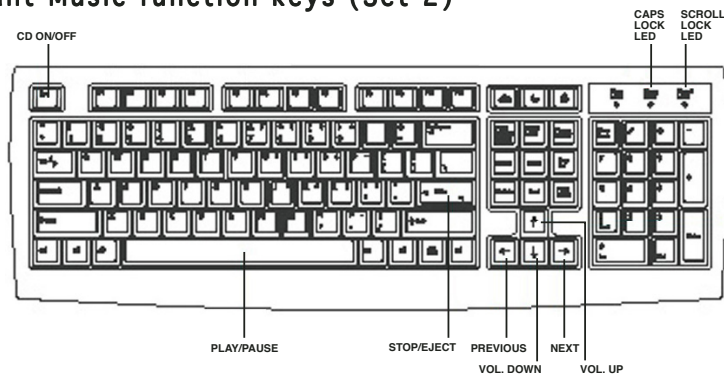

3. Connect the speakers to the Line Out (lime) port on the rear panel for audio output. You may also connect a headphone to the headphone port on the rear/front panel or on the optical drive front panel.
4. Insert an audio CD to the optical drive.
5. Press **Esc** to turn on Instant Music.
6. Press **F1** or the **Space Bar** to play the first track on the audio CD.



If there is no audio CD inside the optical drive, the drive tray ejects when you press <F1> or <Space Bar>.

7. Refer to the Instant Music keyboard label to select other tracks or control the volume.
8. Press <F2> or <Enter> *once* to stop playing the audio CD. Press <F2> or <Enter> *again* to eject the CD.

### 3.4.3 Audio DJ

Audio DJ is an application that allows you to play audio CD/DVD or tune into an FM radio station without entering the operating system.

To put the system in Audio DJ mode:

1. Connect the system power plug to an electrical outlet.
2. Press the CD button (Ⓢ) on the front panel to put the system in Audio DJ mode.

#### Playing an audio CD/DVD

To play an audio CD/DVD:

1. Insert an audio CD/DVD to the optical drive.
2. Press the PLAY/PAUSE (▶/⏸) button to start playing the first track of the audio CD/DVD.
3. Press the NEXT (▶▶) or the PREVIOUS (◀◀) button to skip to the next track or to return to the previous track.
4. Press the STOP (■) button to stop playing the audio track.

#### Tuning into an FM radio station

To tune into an FM station:

1. Press the **MODE** button to put Audio DJ in radio mode.
2. Press the PLAY/PAUSE (▶/⏸) button for less than 2 seconds to scan available radio stations in your location. The station scanning stops when a station is detected.
3. Press the NEXT (▶▶) or the PREVIOUS (◀◀) button to select a preset station, if any.

## Presetting a station

To preset a radio station:

1. Put the Audio DJ in radio mode.
2. Select the radio station you wish to preset by pressing the PLAY/PAUSE (▶/||) button for less than 2 seconds.
3. After selecting the radio station, press the PLAY/PAUSE (▶/||) button for more than 2 seconds or until the station frequency display in the LED panel blinks.
4. Use the NEXT (▶▶) button or the PREVIOUS (◀◀) button to select a preset number (1 ~ 9) for the selected station.
5. Press the PLAY/PAUSE (▶/||) button to assign the preset number to the radio station.

## Adjusting the volume

Press the (◀+) button to increase the volume or the (◀-) button to decrease the volume.



---

Connect a headphone or PC speakers to the rear or front panel Line Out port for audio output.

---

### 3.4.4 Marvell® Yukon Virtual Cable Tester

The Marvell® Virtual Cable Tester™ (VCT) is a cable diagnostic utility that reports LAN cable faults and shorts using the Time Domain Reflectometry (TDR) technology. The VCT detects and reports open and shorted cables, impedance mismatches, pair swaps, pair polarity problems, and pair skew problems of up to 64 ns at one meter accuracy.

The VCT feature reduces networking and support costs through a highly manageable and controlled network system. This utility can be incorporated in the network systems software for ideal field support as well as development diagnostics.

#### Using the Virtual Cable Tester™

To use the the Marvell® Virtual Cable Tester™ utility:

1. Launch the VCT utility from the Windows® desktop by clicking **Start > All Programs > Marvell > Virtual Cable Tester**.
2. Click **Virtual Cable Tester** from the menu to display the screen below.

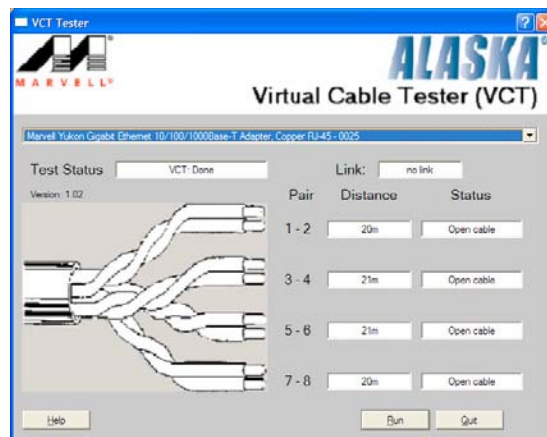

3. Click the **Run** button to perform a cable test.



- The VCT only runs on systems with Windows® XP or Windows® 2000 operating systems.
- The VCT utility only tests Ethernet cables connected to Gigabit LAN port(s).
- The **Run** button on the Virtual Cable Tester™ main window is disabled if no problem is detected on the LAN cable(s) connected to the LAN port(s).
- If you want the system to check the status of the LAN cable before entering the OS, enable the item **Post Check LAN Cable** in the BIOS Setup.

### 3.4.5 Cool 'n' Quiet!™ Technology

The motherboard supports the AMD Cool 'n' Quiet!™ Technology that dynamically and automatically change the CPU speed, voltage, and amount of power depending on the task the CPU performs.

#### Enabling Cool 'n' Quiet!™ Technology

To enable Cool 'n' Quiet!™ Technology:

1. Turn on the system and enter BIOS by pressing the <Del> key during the Power On Self-Tests (POST).
2. Go to the **Advanced Menu -> CPU Configuration**, select the item **Cool 'n'Quiet** and set it to **Enabled**. See section “5.4.5 CPU Configuration.”
3. In the **Power** menu, select the item **ACPI 2.0 Support** and set it to **Yes**. See section “5.5 Power Menu.”
4. Save your changes and exit BIOS Setup.
5. Reboot your computer and set your Power Option Properties depending on your operating system.



The Cool 'n' Quiet!™ Technology item is set to [Enabled] by default in the BIOS.

#### Windows® 2000/XP

1. From the Windows® 2000/XP operating system, click the **Start** button. Select **Settings**, then **Control Panel**.
2. Make sure the Control Panel is set to Classic View.
3. Double-click the **Display** icon in the Control Panel then select the **Screen Saver** tab.
4. Click the **Power...** button. The following dialog box appears.
5. From the **Power schemes** combo list box, select **Minimal Power Management**.
6. Click **OK** to effect settings.

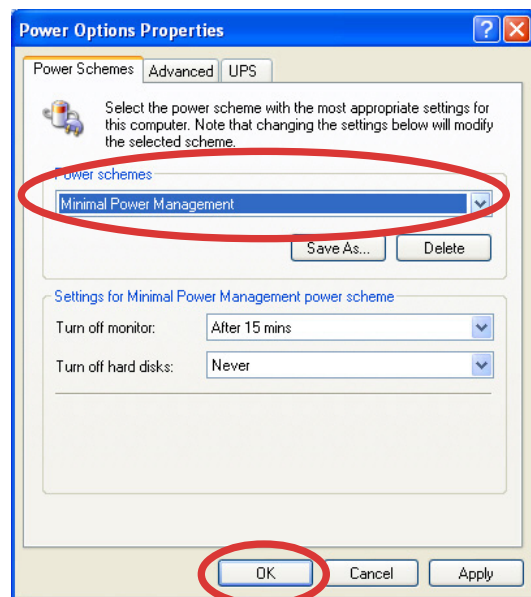

Make sure to install the Cool 'n' Quiet!™ driver and application before using this feature.

## Launching the Cool 'n' Quiet!™ software

The motherboard support CD includes the Cool 'n' Quiet!™ software that enables you to view your system's real-time CPU Frequency and voltage.



---

Make sure to install the Cool 'n' Quiet!™ software from the motherboard support CD. Refer to section "3.3.3 Utilities menu" for details.

---

To launch the Cool 'n' Quiet!™ program:

1. If you are using Windows® 2000, click the **Start** button. Select **Programs-> ASUS -> Cool & Quiet -> Cool & Quiet.**
2. If you are using Windows® XP, click the **Start** button. Select **All Programs-> ASUS -> Cool & Quiet -> Cool & Quiet.**
3. The Cool 'n' Quiet!™ technology screen appears and displays the current CPU Frequency and CPU Voltage.

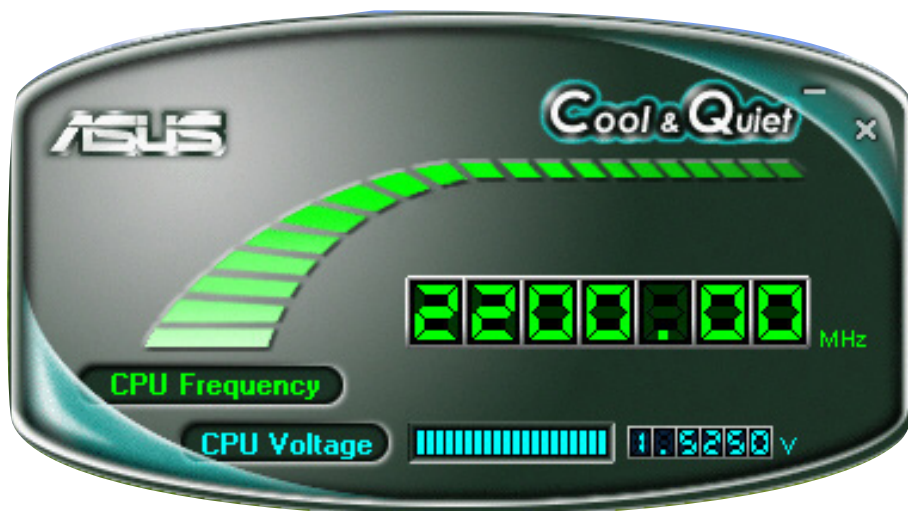

### 3.4.6 ASUS PC Probe II

PC Probe II is a utility that monitors the computer's vital components, and detects and alerts you of any problem with these components. PC Probe II senses fan rotations, CPU temperature, and system voltages, among others. Because PC Probe II is software-based, you can start monitoring your computer the moment you turn it on. With this utility, you are assured that your computer is always at a healthy operating condition.

#### Installing PC Probe II

To install PC Probe II on your computer:

1. Place the support CD to the optical drive. The **Drivers** installation tab appears if your computer has an enabled Autorun feature.



---

If Autorun is not enabled in your computer, browse the contents of the support CD to locate the setup.exe file from the ASUS PC Probe II folder. Double-click the setup.exe file to start installation.

---

2. Click the **Utilities** tab, then click **ASUS PC Probe II**.
3. Follow the screen instructions to complete installation.

#### Launching PC Probe II

You can launch the PC Probe II right after installation or anytime from the Windows® desktop.

To launch the PC Probe II from the Windows® desktop, click **Start > All Programs > ASUS > PC Probe II**. The PC Probe II main window appears.

After launching the application, the PC Probe II icon appears in the Windows® taskbar. Click this icon to close or restore the application.









#### Using PC Probe II

##### *Main window*

The PC Probe II main window allows you to view the current status of your system and change the utility configuration. By default, the main window displays the **Preference** section. You can close or restore the **Preference** section by clicking on the triangle on the main window right handle.



Click to close the Preference panel

Button	Function
	Opens the <b>Configuration</b> window
	Opens the <b>Report</b> window
	Opens the <b>Desktop Management Interface</b> window
	Opens the <b>Peripheral Component Interconnect</b> window
	Opens the <b>Windows Management Instrumentation</b> window
	Opens the hard disk drive, memory, CPU usage window
	Shows/Hides the <b>Preference</b> section
	Minimizes the application
	Closes the application

### *Sensor alert*

When a system sensor detects a problem, the main window right handle turns red, as the illustrations below show.

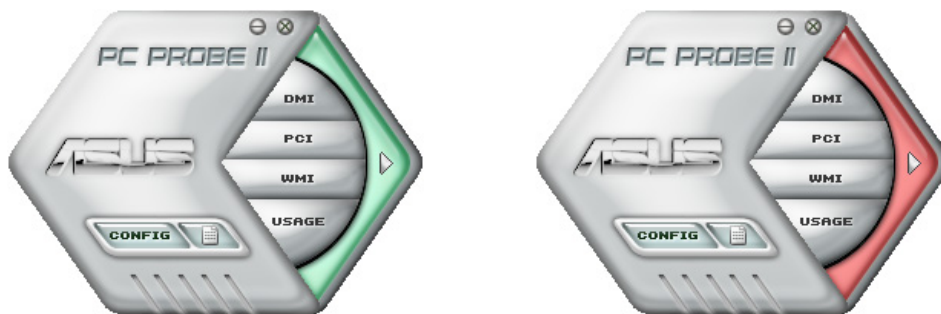

When displayed, the monitor panel for that sensor also turns red. Refer to the **Monitor panels** section for details.

### Preferences

You can customize the application using the Preference section in the main window. Click the box before each preference to activate or deactivate.





## Hardware monitor panels

The hardware monitor panels display the current value of a system sensor such as fan rotation, CPU temperature, and voltages.

The hardware monitor panels come in two display modes: hexagonal (large) and rectangular (small). When you check the **Enable Monitoring Panel** option from the **Preference** section, the monitor panels appear on your computer's desktop.



Large display



Small display

### Changing the monitor panels position

To change the position of the monitor panels in the desktop, click the arrow down button of the **Scheme** options, then select another position from the list box. Click **OK** when finished.





### Moving the monitor panels

All monitor panels move together using a magnetic effect. If you want to detach a monitor panel from the group, click the horseshoe magnet icon. You can now move or reposition the panel independently.



### Adjusting the sensor threshold value

You can adjust the sensor threshold value in the monitor panel by clicking the  or  buttons. You can also adjust the threshold values using the **Config** window.

You cannot adjust the sensor threshold values in a small monitoring panel.

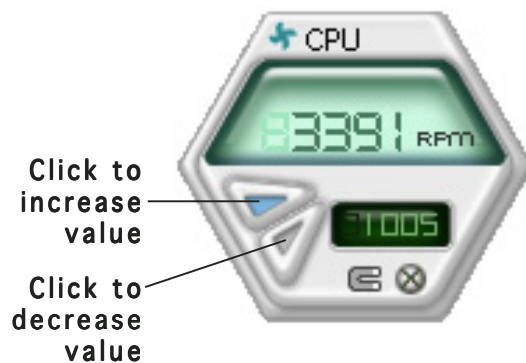

### Monitoring sensor alert

The monitor panel turns red when a component value exceeds or is lower than the threshold value. Refer to the illustrations below.



Large display



Small display

## WMI browser

Click **WMI** to display the WMI (Windows Management Instrumentation) browser. This browser displays various Windows® management information. Click an item from the left panel to display on the right panel. Click the plus sign (+) before **WMI Information** to display the available information.

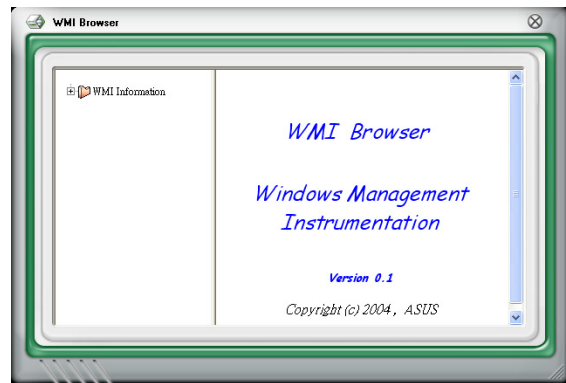

You can enlarge or reduce the browser size by dragging the bottom right corner of the browser.

## DMI browser

Click **DMI** to display the DMI (Desktop Management Interface) browser. This browser displays various desktop and system information. Click the plus sign (+) before **DMI Information** to display the available information.

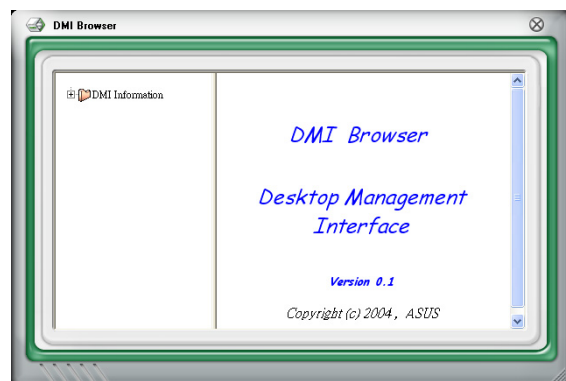

## PCI browser

Click **PCI** to display the PCI (Peripheral Component Interconnect) browser. This browser provides information on the PCI devices installed on your system. Click the plus sign (+) before the **PCI Information** item to display available information.

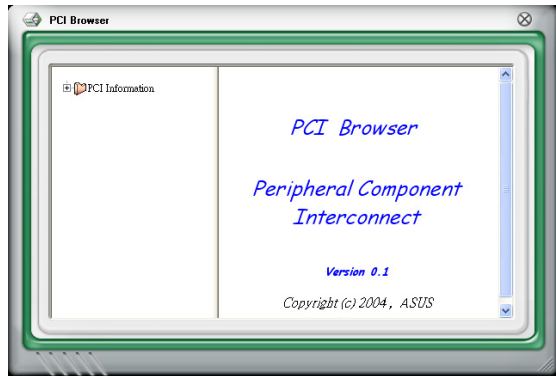

## Usage

The **Usage** browser displays real-time information on the CPU, hard disk drive space, and memory usage. Click **USAGE** to display the Usage browser.

### CPU usage

The **CPU** tab displays real-time CPU usage in line graph representation. If the CPU has an enabled Hyper-Threading\*, two separate line graphs display the operation of the two logical processors.

\*On Intel® CPUs only.

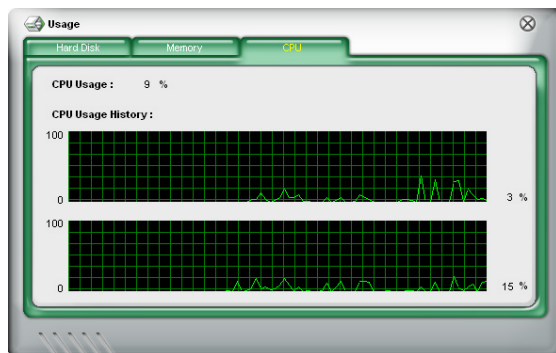

### Hard disk drive space usage

The **Hard Disk** tab displays the used and available hard disk drive space. The left panel of the tab lists all logical drives. Click a hard disk drive to display the information on the right panel. The pie chart at the bottom of the window represents the used (blue) and the available HDD space.

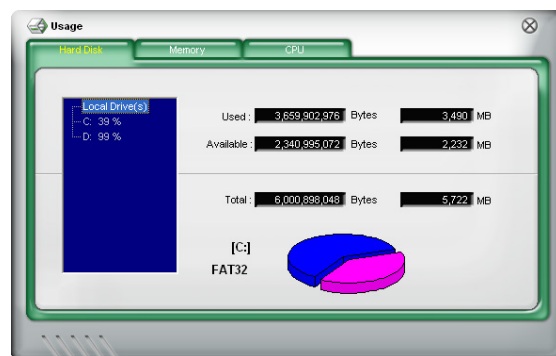

### Memory usage

The Memory tab shows both used and available physical memory. The pie chart at the bottom of the window represents the used (blue) and the available physical memory.

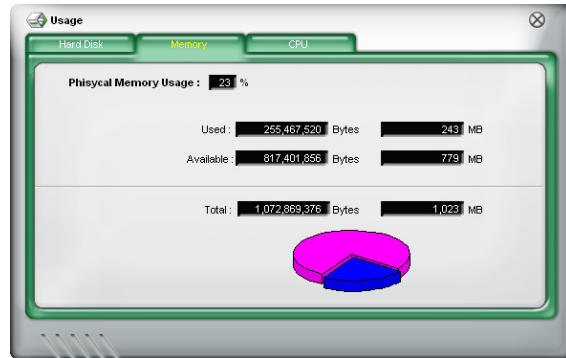

## Configuring PC Probe II

Click **CONFIG** to view and adjust the sensor threshold values.

The **Config** window has two tabs: **Sensor/Threshold** and **Preference**. The **Sensor/Threshold** tab enables you to activate the sensors or to adjust the sensor threshold values. The **Preference** tab allows you to customize sensor alerts, change temperature scale, or enable the Q-Fan feature.\*

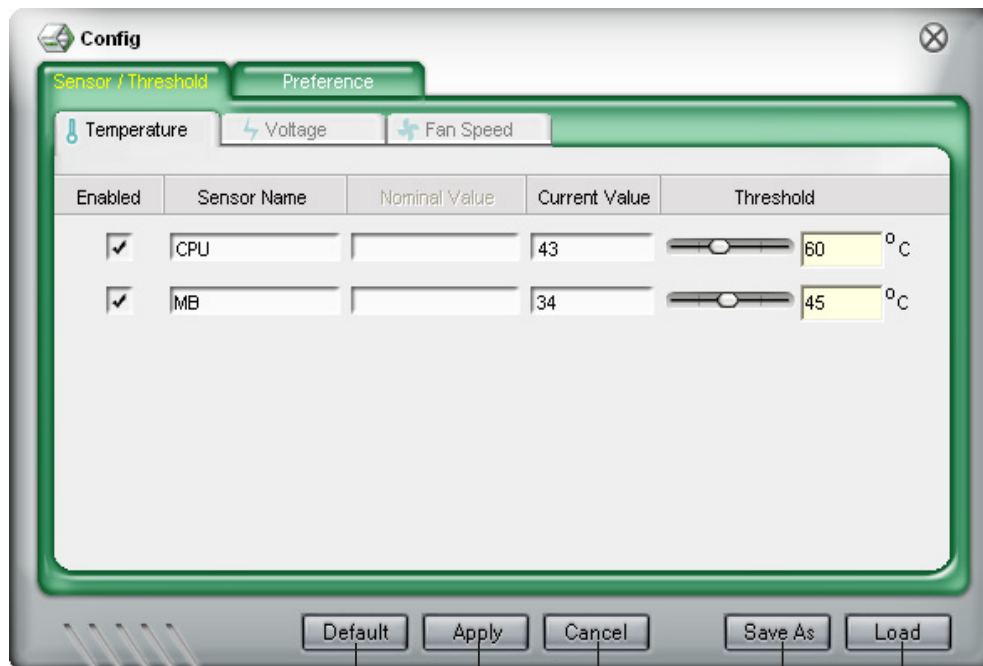

Loads the default threshold values for each sensor

Applies your changes

Cancel or ignores your changes

Loads your saved configuration  
Saves your configuration

\*Available on some motherboards only.

### 3.4.7 AC`97 audio feature

Your barebone system comes with the Realtek® six-channel AC`97 audio CODEC, which features Karaoke , 26 environment sound emulations, and a 10-band equalizer on the AVRack® Media Player for enhanced entertainment and gaming experience.

#### Installing the drivers and application

To install the drivers and application:

1. Place the support CD in the optical drive.
2. When the drivers menu appears, click **Realtek Audio Driver**.

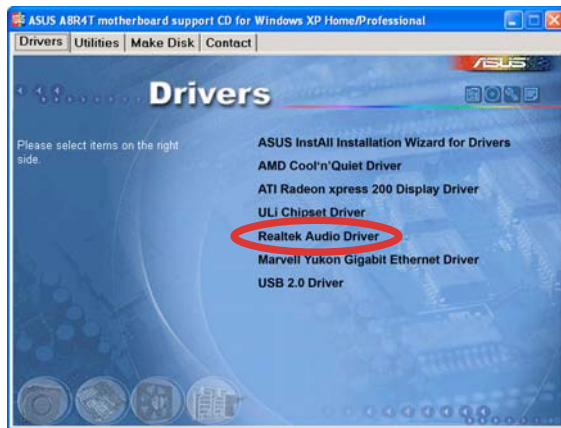

3. Installation begins automatically. Click **Next**.

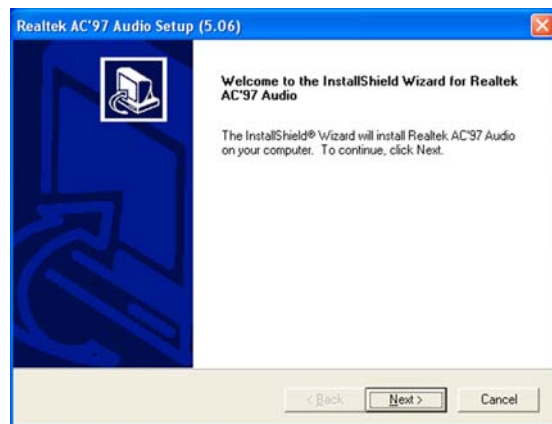

4. The **Setup Status** window appears, indicating the progress of the installation.

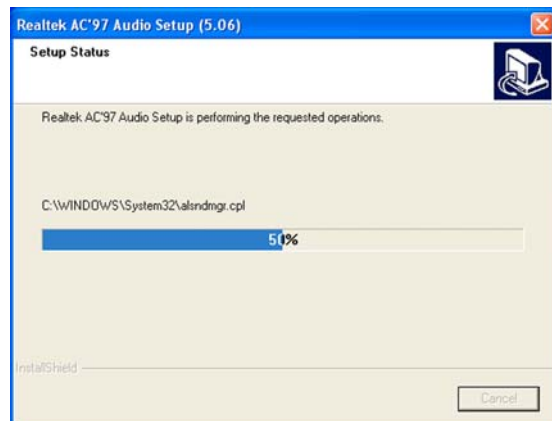

5. The drivers are installed into your system.

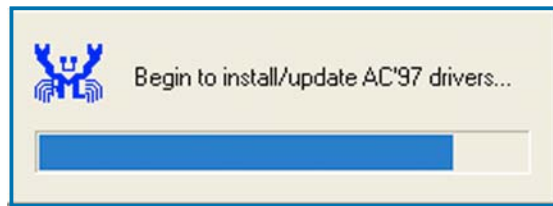

6. The **InstallShield Wizard Complete** window appears, indicating that installation is complete.

Click **Yes** to restart your computer now, or **No** to restart later.

Click **Finish**.



## Using the AVRack® Media Player

### Launching the AVRack® Media Player

A shortcut to the AVRack® Media Player is automatically created on your desktop after you installed the audio drivers and application. To launch the application, simply double-click the icon.



### The AVRack® Media Player interface



Classic skin

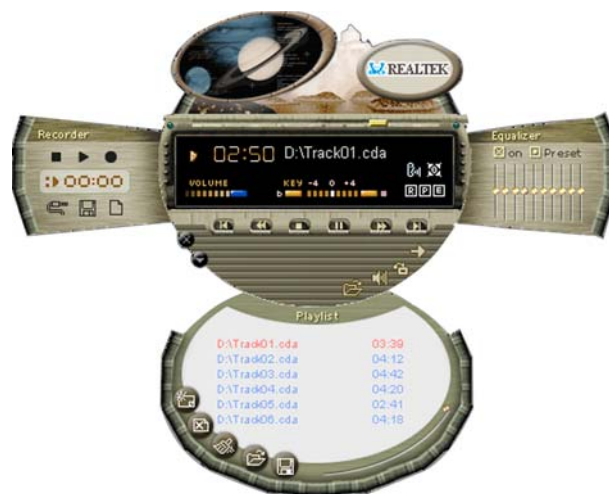

Base skin

*The AVRack® Media Player controls*

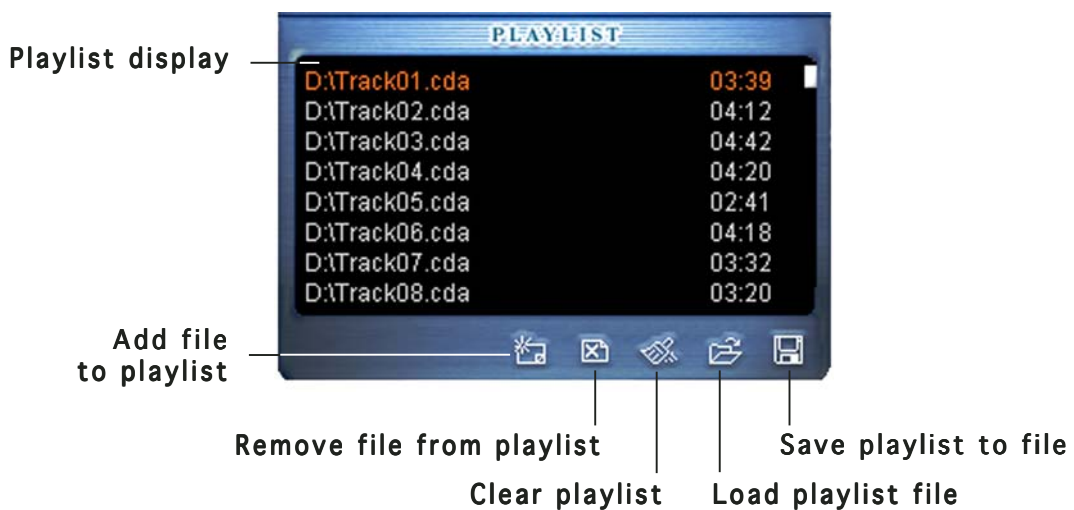
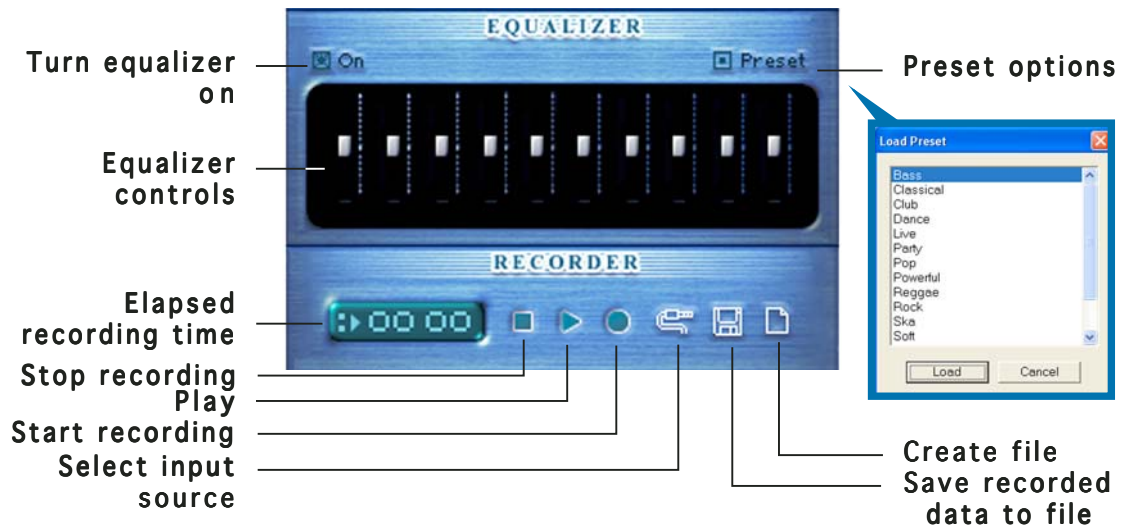





# Chapter 4

This chapter gives information about the motherboard that comes with the system. This chapter includes the motherboard layout, jumper settings, and connector locations.

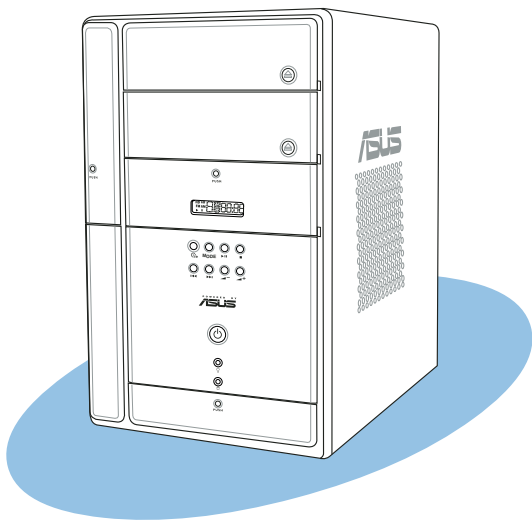

ASUS T2-AH1

## 4.1 Introduction

An ASUS motherboard comes already installed in the ASUS T2-AH1 system. This chapter provides technical information about the motherboard for future upgrades or system reconfiguration.

## 4.2 Motherboard layout

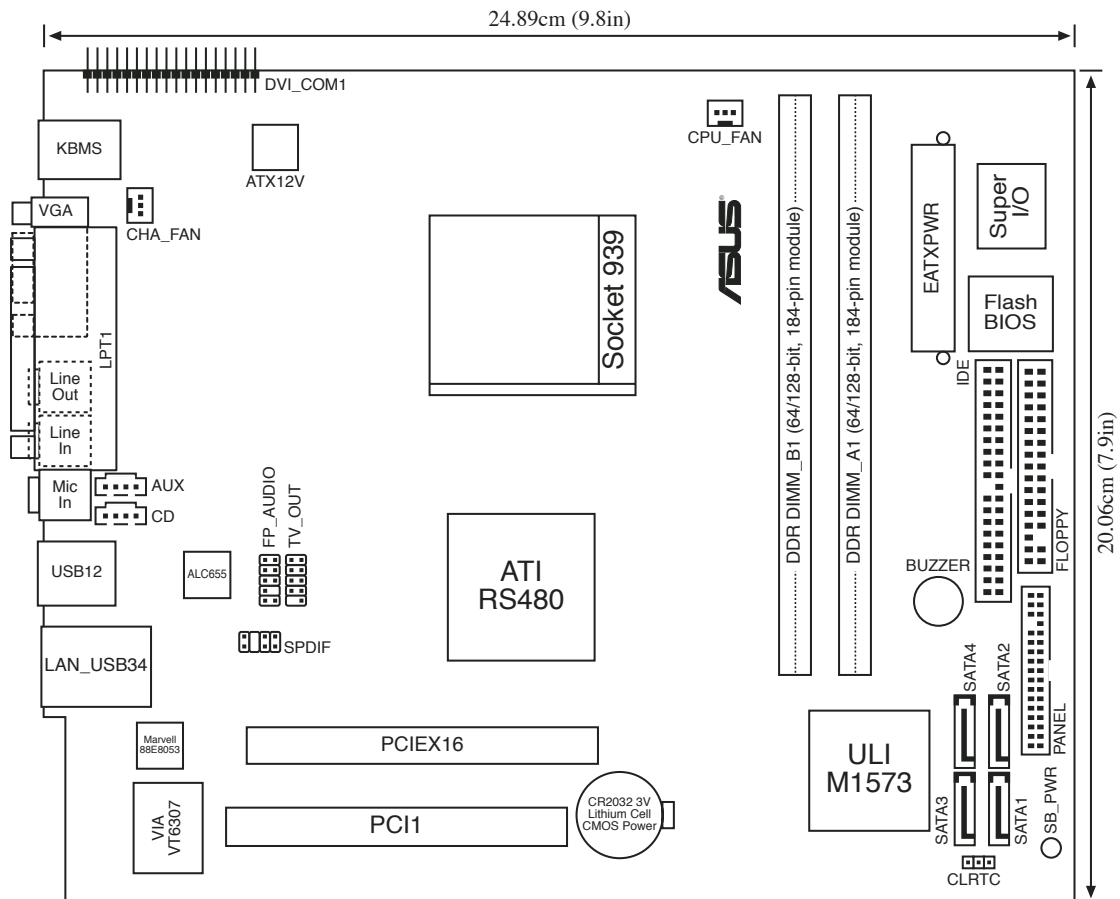

## 4.3 Jumper

### Clear RTC RAM (CLRTC)

This jumper allows you to clear the Real Time Clock (RTC) RAM in CMOS. You can clear the CMOS memory of date, time, and system setup parameters by erasing the CMOS RTC RAM data. The RAM data in CMOS, that include system setup information such as system passwords, is powered by the onboard button cell battery.

To erase the RTC RAM:

1. Turn OFF the computer and unplug the power cord.
2. Remove the battery.
3. Move the jumper cap from pins 1-2 (default) to pins 2-3. Keep the cap on pins 2-3 for about 5-10 seconds, then move the cap back to pins 1-2.
4. Re-install the battery.
5. Plug the power cord and turn ON the computer.
6. Hold down the <Del> key during the boot process and enter BIOS setup to re-enter data.

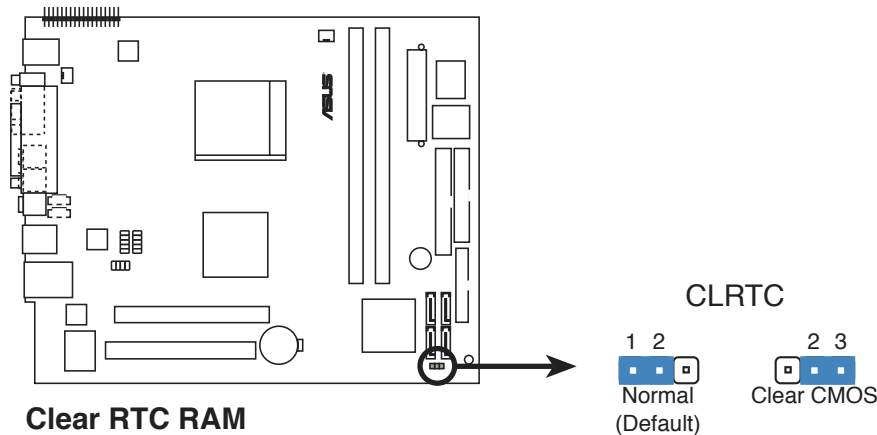

Except when clearing the RTC RAM, never remove the cap on CLRTC jumper default position. Removing the cap will cause system boot failure.

## 4.4 Connectors

This section describes and illustrates the connectors on the motherboard. See page 1-7 for the description of rear panel connectors.

### 1. Front panel audio connector (10-1 pin FP\_AUDIO)

This interface is for the FP\_AUDIO connector on the front panel I/O daughterboard to support the front panel audio I/O ports.

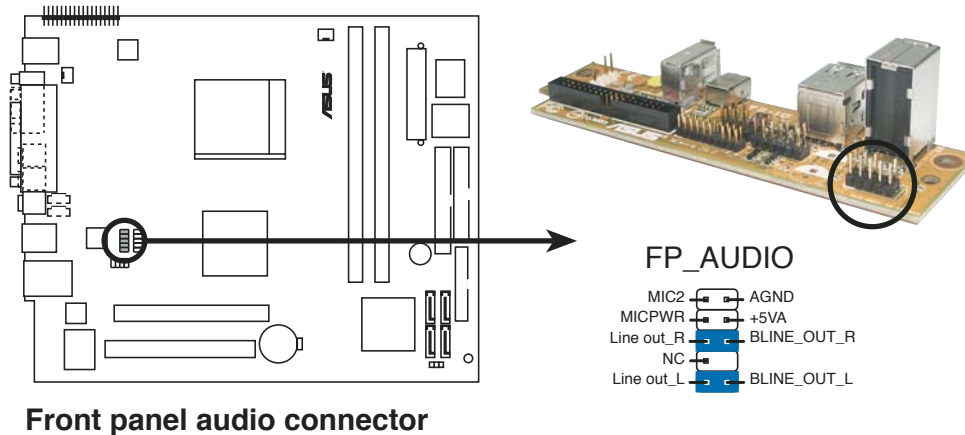

### 2. Digital audio connector (8-2 pin SPDIF)

(A) is for the SPDIF connector on the motherboard while (B) is for the rear panel S/PDIF Out port. For the front panel S/PDIF port, connect the S/PDIF cable to the SPDIF\_IN connector on the front panel I/O board.

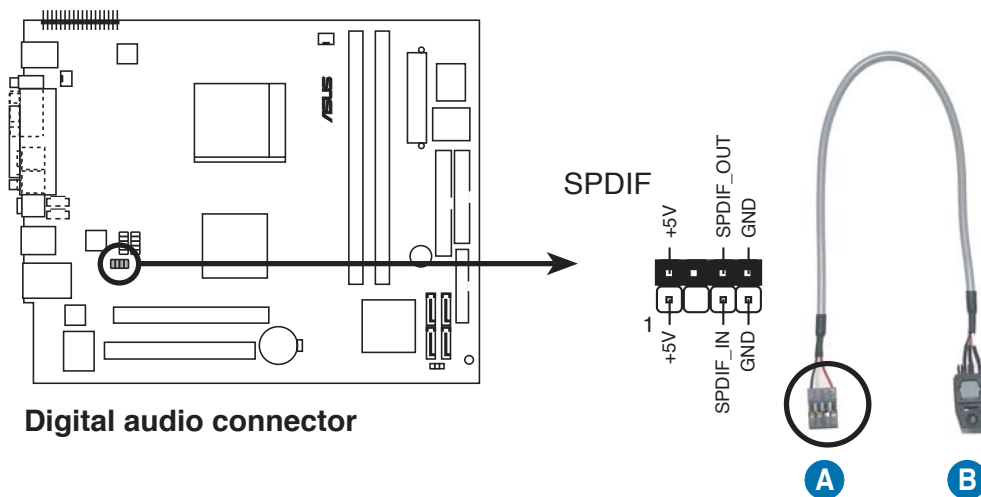

### 3. TV-out connector (10-1-pin TV\_OUT)

This 6-1 pin connector is for the TV-out port module that allows you to connect a television to your system. Connect one end of the TV-out cable to the connector and the other end to the TV-out module.

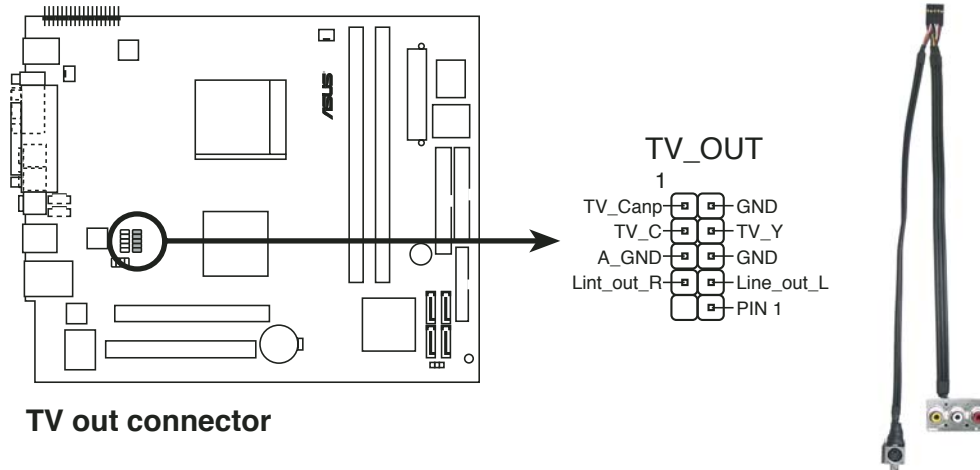

**TV out connector**



The TV-out module is purchased separately.

### 4. CPU and chassis fan connectors (3-pin CPU\_FAN, 3-pin CHA\_FAN)

The fan connectors support the proprietary CPU fan and chassis fan. Connect the fan cables to the fan connectors on the motherboard, making sure that the black wire of each cable matches the ground pin of the connector.



Do not forget to connect the fan cables to the fan connectors. Insufficient air flow within the system may damage the motherboard components. These are not jumpers! DO NOT place jumper caps on the fan connectors!

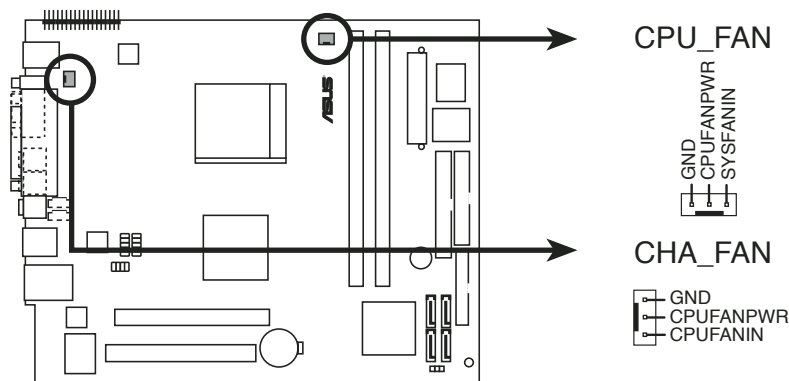

**Fan connectors**

## 5. ATX power connectors (24-pin EATXPWR, 4-pin ATX12V)

These connectors are for the 24-pin and 4-pin power plugs from the power supply unit. The plugs from the power supply unit are designed to fit these connectors in only one orientation. Find the proper orientation and push down firmly until the connectors completely fit.

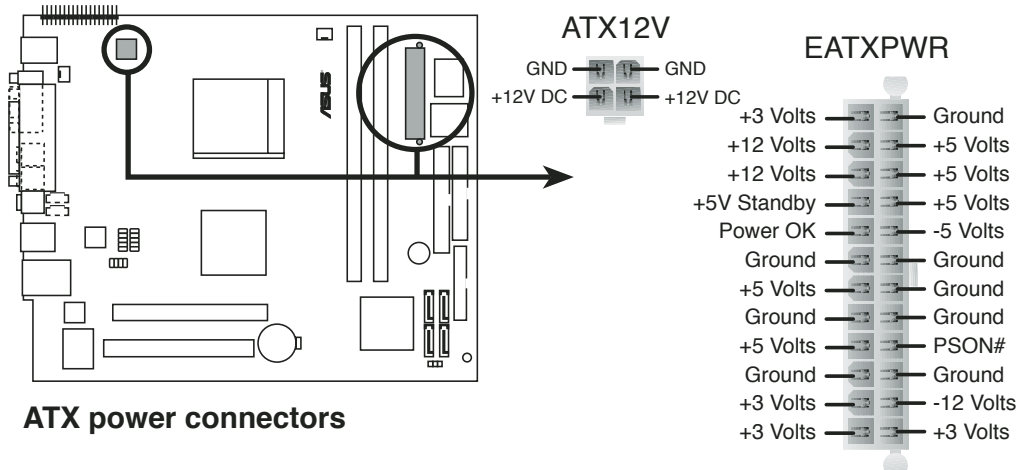

Do not forget to connect the 4-pin ATX12V power plug to the ATX12V connector on the motherboard; otherwise, the system will not boot up.

## 6. Floppy disk drive connector (34-1 pin FLOPPY)

This connector is for the provided floppy disk drive (FDD) signal cable. Insert one end of the cable to this connector, then connect the other end to the signal connector at the back of the floppy disk drive.



Pin 5 on the connector is removed to prevent incorrect cable connection when using an FDD cable with a covered Pin 5.

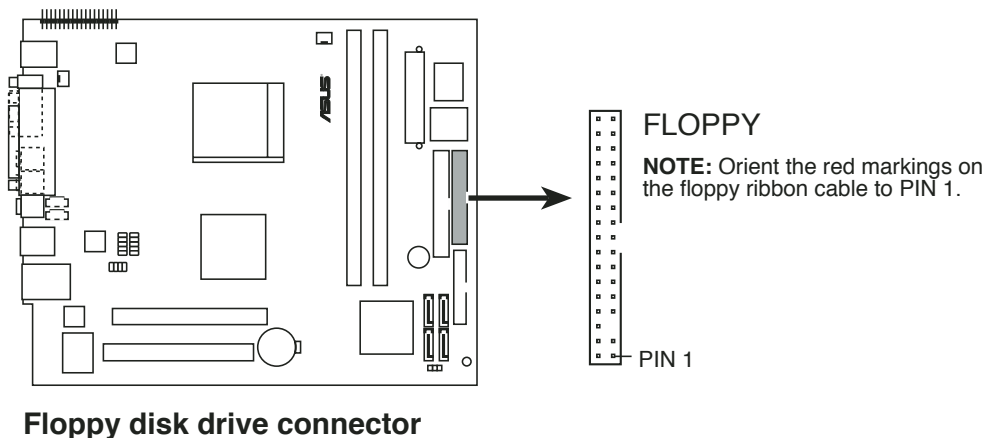

## 7. IDE connector (40-1 pin IDE)

This connector is for an Ultra DMA 100/66 signal cable. The Ultra DMA 100/66 signal cable has three connectors: a blue connector for the primary IDE connector on the motherboard, a black connector for an Ultra DMA 100/66 IDE slave device (optical drive/hard disk drive), and a gray connector for an Ultra DMA 100/66 IDE master device (hard disk drive). Refer to the hard disk documentation for the jumper settings.



- Pin 20 on the IDE connector is removed to match the covered hole on the Ultra DMA cable connector. This prevents incorrect insertion when you connect the IDE cable.
- Use the 80-conductor IDE cable for Ultra DMA 100/66 IDE devices.

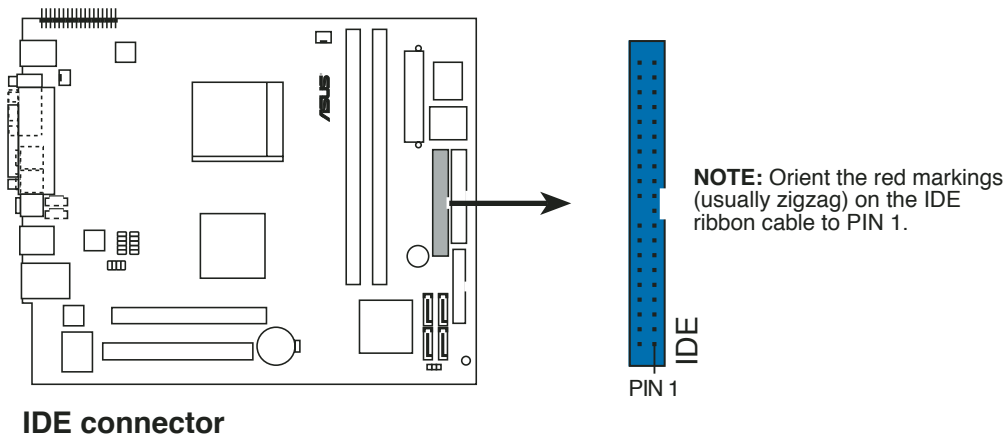

## 8. Internal audio connectors (4-pin AUX, CD)

These connectors allow you to receive stereo audio input from sound sources such as a CD-ROM, TV tuner, or MPEG card.

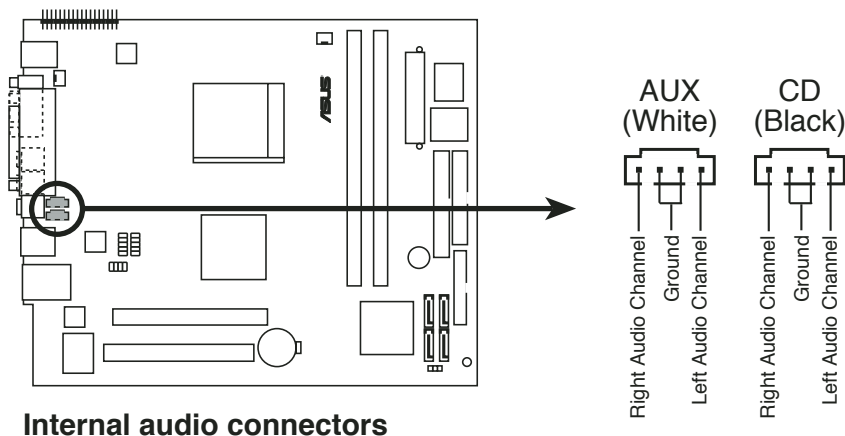

## 9. Serial ATA connectors (7-pin SATA1 [black], SATA2 [black], SATA3 [black], SATA4 [black])

These connectors are for the Serial ATA signal cables for Serial ATA hard disk drives.

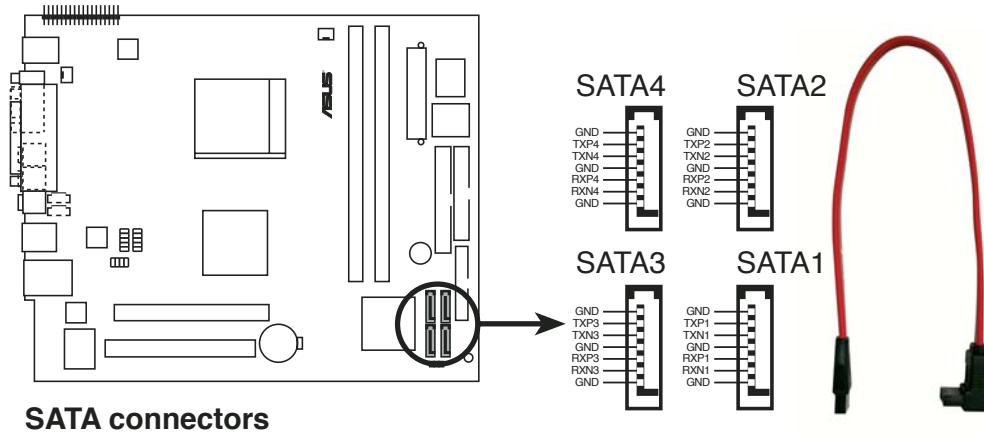

**SATA connectors**



---

### Important note on Serial ATA

You must install Windows® 2000 or the Windows® XP/2003 before using Serial ATA hard disk drives.

---



## 10. System panel connector (34-1 pin PANEL)

This connector accommodates several system front panel functions.

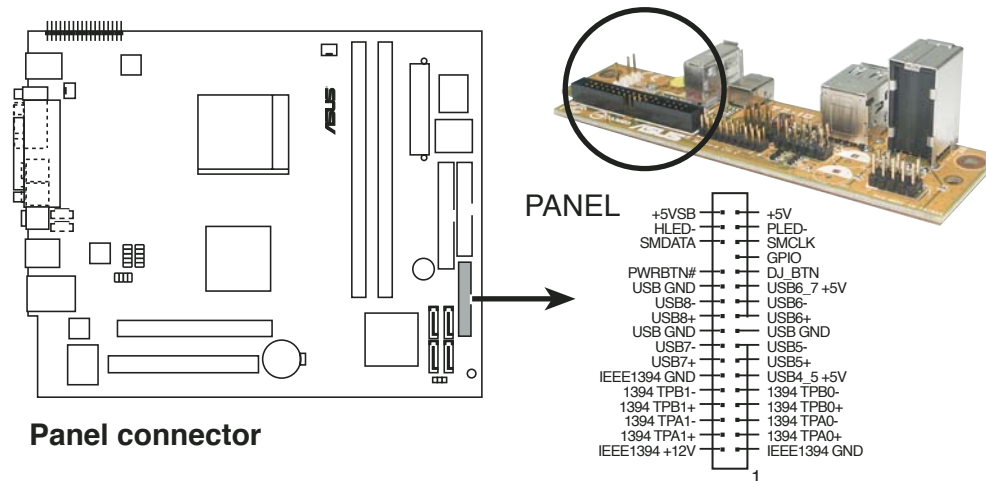

- **IEEE 1394 connectors (5-pin 1394, 6-pin IEEE1394)**  
These connectors are for the IEEE 1394a connectors on the front panel I/O daughterboard to support the front panel IEEE 1394a ports.
- **USB 2.0 connectors (6-pin USB4\_5, 7-pin USB6\_7)**  
USB4 is for connector on the storage card reader daughterboard.  
USB5 is for the remote controller.  
USB6 and USB7 are for the user's USB devices to be connected on the front I/O.
- **System power LED (1-pin PLED-)**  
This 1-pin connector is for the system power LED. The system power LED lights up when you turn on the system power, and blinks when the system is in sleep mode.
- **Hard disk drive activity (1-pin HDLED)**  
This connector is for the HDD Activity LED. The IDE LED lights up or flashes when data is read from or written to the HDD.
- **Power button (1-pin PWRBTN)**  
This connector is for the system power button. Pressing the power button turns the system ON or puts the system in SLEEP or SOFT-OFF mode depending on the BIOS settings.
- **DJ button (1-pin DJ BTN)**  
This is for the Audio DJ module on the front panel to support the Audio DJ buttons.



# Chapter 5

This chapter tells how to change system settings through the BIOS Setup menus and describes the BIOS parameters.

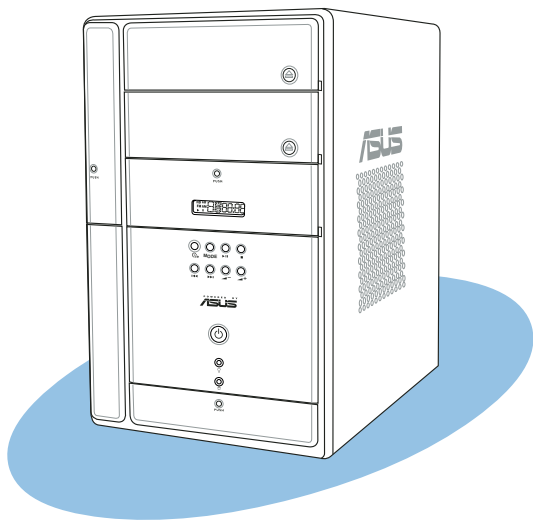

ASUS T2-AH1

## 5.1 Managing and updating your BIOS

The following utilities allow you to manage and update the motherboard Basic Input/Output System (BIOS) setup.

1. **ASUS AFUDOS** (Updates the BIOS in DOS mode using a bootable floppy disk.)
2. **ASUS EZ Flash** (Updates the BIOS using a floppy disk during POST.)
3. **ASUS CrashFree BIOS 2** (Updates the BIOS using a bootable floppy disk or the motherboard support CD when the BIOS file fails or gets corrupted.)
4. **ASUS Update** (Updates the BIOS in Windows® environment.)

Refer to the corresponding sections for details on these utilities.



---

Save a copy of the original motherboard BIOS file to a bootable floppy disk in case you need to restore the BIOS in the future. Copy the original motherboard BIOS using the ASUS Update or AFUDOS utilities.

---

### 5.1.1 Creating a bootable floppy disk

1. Do either one of the following to create a bootable floppy disk.

#### *DOS environment*

- a. Insert a 1.44MB floppy disk into the drive.
- b. At the DOS prompt, type `format A: /S` then press <Enter>.

#### *Windows® XP environment*

- a. Insert a 1.44 MB floppy disk to the floppy disk drive.
- b. Click **Start** from the Windows® desktop, then select **My Computer**.
- c. Select the 3 1/2 Floppy Drive icon.
- d. Click **File** from the menu, then select **Format**. A **Format 3 1/2 Floppy Disk** window appears.
- e. Select **Create an MS-DOS startup disk** from the format options field, then click **Start**.

#### *Windows® 2000 environment*

To create a set of boot disks for Windows® 2000:

- a. Insert a formatted, high density 1.44 MB floppy disk into the drive.
- b. Insert the Windows® 2000 CD to the optical drive.
- c. Click **Start**, then select **Run**.

- d. From the Open field, type  
`D:\bootdisk\makeboot a:`  
 assuming that D: is your optical drive.
  - e. Press <Enter>, then follow screen instructions to continue.
2. Copy the original or the latest motherboard BIOS file to the bootable floppy disk.

### 5.1.2 ASUS EZ Flash utility

The ASUS EZ Flash feature allows you to update the BIOS without having to go through the long process of booting from a floppy disk and using a DOS-based utility. The EZ Flash utility is built-in the BIOS chip so it is accessible by pressing <Alt> + <F2> during the Power-On Self Tests (POST).

To update the BIOS using EZ Flash:

1. Visit the ASUS website ([www.asus.com](http://www.asus.com)) to download the latest BIOS file for the motherboard and rename the same to **A8R4T.ROM**.
2. Save the BIOS file to a floppy disk, then restart the system.
3. Press <Alt> + <F2> during POST to display the following.

```
EZFlash starting BIOS update
Checking for floppy...
```

4. Insert the floppy disk that contains the BIOS file to the floppy disk drive. When the correct BIOS file is found, EZ Flash performs the BIOS update process and automatically reboots the system when done.

```
EZFlash starting BIOS update
Checking for floppy...
Floppy found!
Reading file "A8R4T.ROM". Completed.
Start erasing.....|
Start programming...|
Flashed successfully. Rebooting.
```



- Do not shut down or reset the system while updating the BIOS to prevent system boot failure!
- A “Floppy not found!” error message appears if there is no floppy disk in the drive. A “A8R4T.ROM not found!” error message appears if the correct BIOS file is not found in the floppy disk. Make sure that you rename the BIOS file to A8R4T.ROM.
- The EZ Flash utility does not support BIOS update using a USB floppy.

### 5.1.3 AFUDOS utility

The AFUDOS utility allows you to update the BIOS file in DOS environment using a bootable floppy disk with the updated BIOS file. This utility also allows you to copy the current BIOS file that you can use as backup when the BIOS fails or gets corrupted during the updating process.

#### Copying the current BIOS

To copy the current BIOS file using the AFUDOS utility:



- Make sure that the floppy disk is not write-protected and has at least 600 KB free space to save the file.
- The succeeding BIOS screens are for reference only. The actual BIOS screen displays may not be exactly the same as shown.

1. Copy the AFUDOS utility (afudos.exe) from the motherboard support CD to the bootable floppy disk you created earlier.
2. Boot the system in DOS mode, then at the prompt type:

```
afudos /o[filename]
```

where the [filename] is any user-assigned filename not more than eight alphanumeric characters for the main filename and three alphanumeric characters for the extension name.

```
A:\>afudos /oOLDBIOS1.ROM
```

Main filename

Extension name

3. Press <Enter>. The utility copies the current BIOS file to the floppy disk.

```
A:\>afudos /oOLDBIOS1.ROM
AMI Firmware Update Utility - Version 1.10
Copyright (C) 2002 American Megatrends, Inc. All rights reserved.
  Reading flash ..... done
A:\>
```

The utility returns to the DOS prompt after copying the current BIOS file.

## Updating the BIOS file

To update the BIOS file using the AFUDOS utility:

1. Visit the ASUS website ([www.asus.com](http://www.asus.com)) and download the latest BIOS file for the motherboard. Save the BIOS file to a bootable floppy disk.



---

Write the BIOS filename on a piece of paper. You need to type the exact BIOS filename at the DOS prompt.

---

2. Copy the AFUDOS utility (afudos.exe) from the motherboard support CD to the bootable floppy disk you created earlier.
3. Boot the system in DOS mode, then at the prompt type:

```
afudos /i[filename]
```

where [filename] is the latest or the original BIOS file on the bootable floppy disk.

```
A:\>afudos /iA8R4T.ROM
```

4. The utility reads the file and starts updating the BIOS.

```
A:\>afudos /iA8R4T.ROM
AMI Firmware Update Utility - Version 1.19 (ASUS V2.07 (03.11.24BB))
Copyright (C) 2003 American Megatrends, Inc. All rights reserved.

WARNING!! Do not turn off power during flash BIOS
Reading file ..... done
Reading flash .... done
Search bootblock version
Advance Check.....
Erasing flash .... done
Writing flash .... 0x0008CC00 (9%)
```



---

Do not shut down or reset the system while updating the BIOS to prevent system boot failure!

---

5. The utility returns to the DOS prompt after the BIOS update process is completed. Reboot the system from the hard disk drive.

```
A:\>afudos /iA8R4T.ROM
AMI Firmware Update Utility - Version 1.19(ASUS V2.07(03.11.24BB))
Copyright (C) 2003 American Megatrends, Inc. All rights reserved.

WARNING!! Do not turn off power during flash BIOS
Reading file .... done
Reading flash .... done
Search bootblock version
Advance Check.....
Erasing flash .... done
Writing flash .... done
Verifying flash ... done

Please restart your computer

A:\>
```

### 5.1.4 ASUS CrashFree BIOS 2 utility

The ASUS CrashFree BIOS 2 is an auto recovery tool that allows you to restore the BIOS file when it fails or gets corrupted during the updating process. You can update a corrupted BIOS file using the motherboard support CD or the floppy disk that contains the updated BIOS file.



- 
- Prepare the motherboard support CD or the floppy disk containing the updated motherboard BIOS before using this utility.
  - Make sure that you rename the original or updated BIOS file in the floppy disk to **A8R4T.ROM**.
- 

### Recovering the BIOS from a floppy disk

To recover the BIOS from a floppy disk:

1. Turn on the system.
2. Insert the floppy disk with the original or updated BIOS file to the floppy disk drive.



3. The utility displays the following message and automatically checks the floppy disk for the original or updated BIOS file.

```
Bad BIOS checksum. Starting BIOS recovery...
Checking for floppy...
```

When found, the utility reads the BIOS file and starts flashing the corrupted BIOS file.

```
Bad BIOS checksum. Starting BIOS recovery...
Checking for floppy...
Floppy found!
Reading file "A8R4T.ROM". Completed.
Start flashing...
```



---

DO NOT shut down or reset the system while updating the BIOS! Doing so can cause system boot failure!

---

4. Restart the system after the utility completes the updating process.

## Recovering the BIOS from the support CD

To recover the BIOS from the support CD:

1. Remove any floppy disk from the floppy disk drive, then turn on the system.
2. Insert the support CD to the optical drive.
3. The utility displays the following message and automatically checks the floppy disk for the original or updated BIOS file.

```
Bad BIOS checksum. Starting BIOS recovery...
Checking for floppy...
```

When no floppy disk is found, the utility automatically checks the optical drive for the original or updated BIOS file. The utility then updates the corrupted BIOS file.

```
Bad BIOS checksum. Starting BIOS recovery...
Checking for floppy...
Floppy not found!
Checking for CD-ROM...
CD-ROM found!
Reading file "A8R4T.ROM". Completed.
Start flashing...
```



---

DO NOT shut down or reset the system while updating the BIOS! Doing so can cause system boot failure!

---

4. Restart the system after the utility completes the updating process.



---

The recovered BIOS may not be the latest BIOS version for this motherboard. Visit the ASUS website ([www.asus.com](http://www.asus.com)) to download the latest BIOS file.

---

### 5.1.5 ASUS Update utility

The ASUS Update is a utility that allows you to manage, save, and update the motherboard BIOS in Windows® environment. The ASUS Update utility allows you to:

- Save the current BIOS file
- Download the latest BIOS file from the Internet
- Update the BIOS from an updated BIOS file
- Update the BIOS directly from the Internet, and
- View the BIOS version information.

This utility is available in the support CD that comes with the motherboard package.



---

ASUS Update requires an Internet connection either through a network or an Internet Service Provider (ISP).

---

### Installing ASUS Update

To install ASUS Update:

1. Place the support CD in the optical drive. The **Drivers** menu appears.
2. Click the **Utilities** tab, then click **Install ASUS Update VX.XX.XX**. See page 3-4 for the **Utilities** screen menu.
3. The ASUS Update utility is copied to your system.

---

Quit all Windows® applications before you update the BIOS using this utility.

---

## Updating the BIOS through the Internet

To update the BIOS through the Internet:

1. Launch the ASUS Update utility from the Windows® desktop by clicking **Start > Programs > ASUS > ASUSUpdate > ASUSUpdate**. The ASUS Update main window appears.

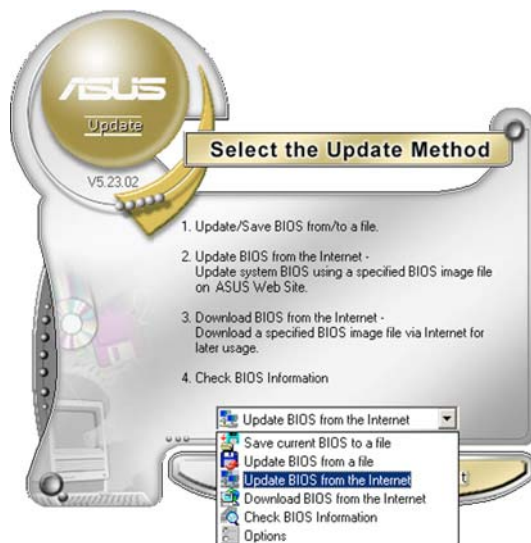
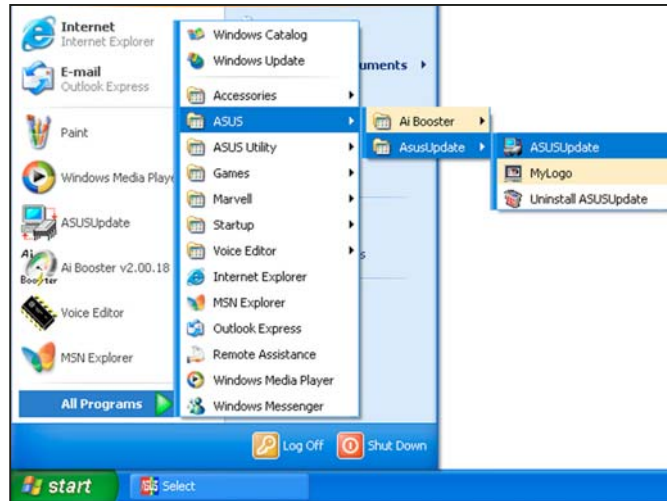

2. Select **Update BIOS from the Internet** option from the drop-down menu, then click **Next**.



3. Select the ASUS FTP site nearest you to avoid network traffic, or click **Auto Select**. Click **Next**.

- From the FTP site, select the BIOS version that you wish to download. Click Next.
- Follow the screen instructions to complete the update process.



The ASUS Update utility is capable of updating itself through the Internet. Always update the utility to avail all its features.



## Updating the BIOS through a BIOS file

To update the BIOS through a BIOS file:

- Launch the ASUS Update utility from the Windows® desktop by clicking **Start > Programs > ASUS > ASUSUpdate > ASUSUpdate**. The ASUS Update main window appears.
- Select **Update BIOS from a file** option from the drop-down menu, then click **Next**.

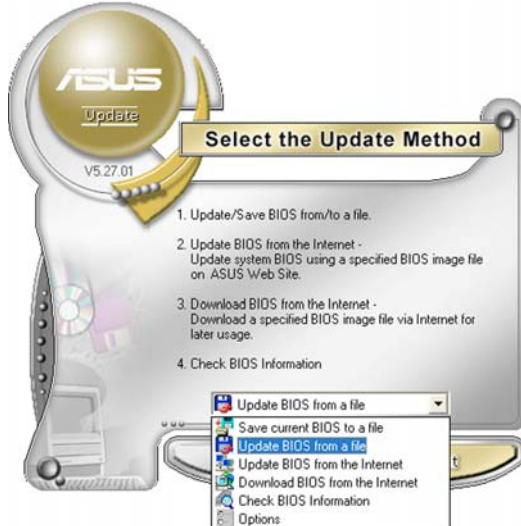

- Locate the BIOS file from the **Open** window, then click **Save**.
- Follow the screen instructions to complete the update process.

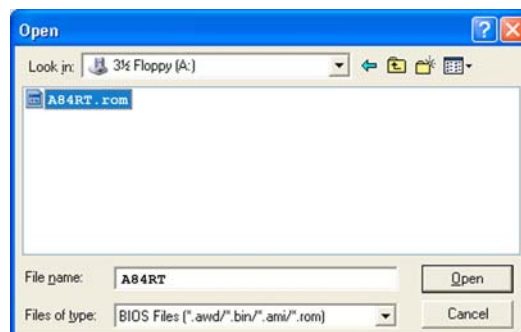

## 5.2 BIOS setup program

This motherboard supports a programmable firmware chip that you can update using the provided utility described in section “5.1 Managing and updating your BIOS.”

Use the BIOS Setup program when you are installing a motherboard, reconfiguring your system, or prompted to “Run Setup.” This section explains how to configure your system using this utility.

Even if you are not prompted to use the Setup program, you can change the configuration of your computer in the future. For example, you can enable the security password feature or change the power management settings. This requires you to reconfigure your system using the BIOS Setup program so that the computer can recognize these changes and record them in the CMOS RAM of the firmware hub.

The firmware hub on the motherboard stores the Setup utility. When you start up the computer, the system provides you with the opportunity to run this program. Press <Del> during the Power-On-Self-Test (POST) to enter the Setup utility; otherwise, POST continues with its test routines.

If you wish to enter Setup after POST, restart the system by pressing <Ctrl+Alt+Delete>. You can also restart by turning the system off and then back on. Do this last option only if the first two failed.

The Setup program is designed to make it as easy to use as possible. Being a menu-driven program, it lets you scroll through the various sub-menus and make your selections from the available options using the navigation keys.



- 
- The default BIOS settings for this motherboard apply for most conditions to ensure optimum performance. If the system becomes unstable after changing any BIOS settings, load the default settings to ensure system compatibility and stability. Select the **Load Default Settings** item under the Exit Menu. See section “5.7 Exit Menu.”
  - The BIOS setup screens shown in this section are for reference purposes only, and may not exactly match what you see on your screen.
  - Visit the ASUS website ([www.asus.com](http://www.asus.com)) to download the latest BIOS file for this motherboard.
-

## 5.2.1 BIOS menu screen

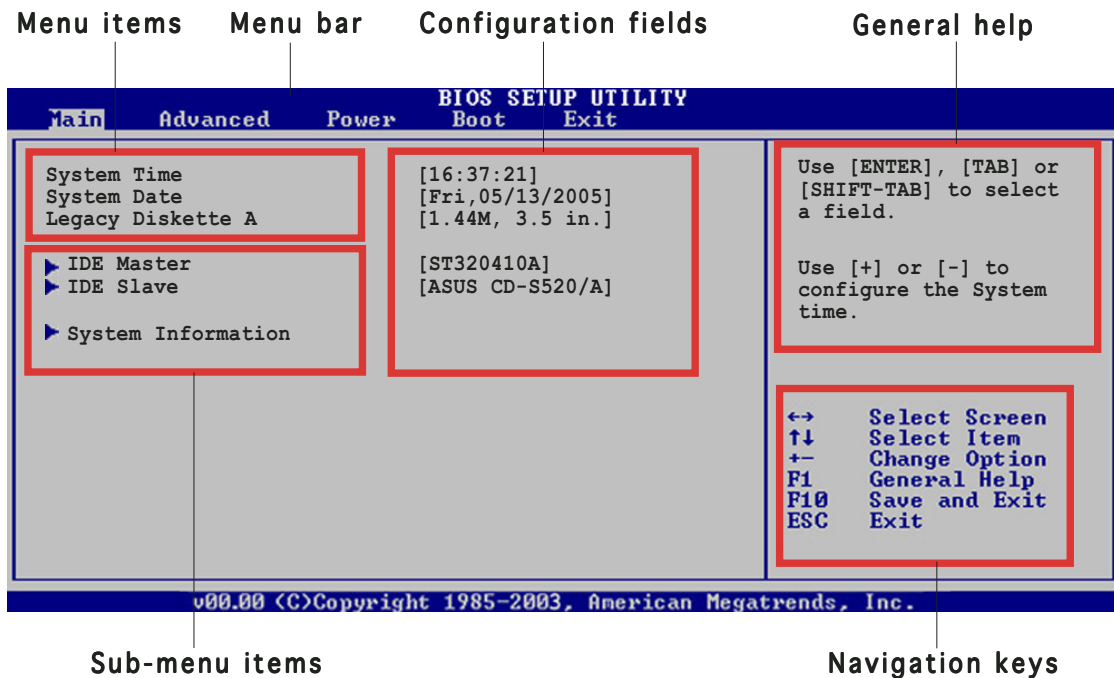

## 5.2.2 Menu bar

The menu bar on top of the screen has the following main items:

<b>Main</b>	For changing the basic system configuration
<b>Advanced</b>	For changing the advanced system settings
<b>Power</b>	For changing the advanced power management (APM) configuration
<b>Boot</b>	For changing the system boot configuration
<b>Exit</b>	For selecting the exit options and loading default settings

To select an item on the menu bar, press the right or left arrow key on the keyboard until the desired item is highlighted.

## 5.2.3 Navigation keys

At the bottom right corner of a menu screen are the navigation keys for that particular menu. Use the navigation keys to select items in the menu and change the settings.



Some of the navigation keys differ from one screen to another.

## 5.2.4 Menu items

The highlighted item on the menu bar displays the specific items for that menu. For example, selecting **Main** shows the Main menu items.

The other items (Advanced, Power, Boot, and Exit) on the menu bar have their respective menu items.

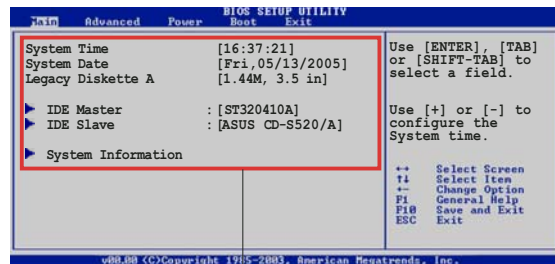

Main menu items

## 5.2.5 Sub-menu items

A solid triangle before each item on any menu screen means that the item has a sub-menu. To display the sub-menu, select the item and press <Enter>.

## 5.2.6 Configuration fields

These fields show the values for the menu items. If an item is user-configurable, you can change the value of the field opposite the item. You cannot select an item that is not user-configurable.

A configurable field is enclosed in brackets, and is highlighted when selected. To change the value of a field, select it then press <Enter> to display a list of options. Refer to “5.2.7 Pop-up window.”

## 5.2.7 Pop-up window

Select a menu item then press <Enter> to display a pop-up window with the configuration options for that item.

## 5.2.8 Scroll bar

A scroll bar appears on the right side of a menu screen when there are items that do not fit on the screen. Press the Up/Down arrow keys or <Page Up> / <Page Down> keys to display the other items on the screen.

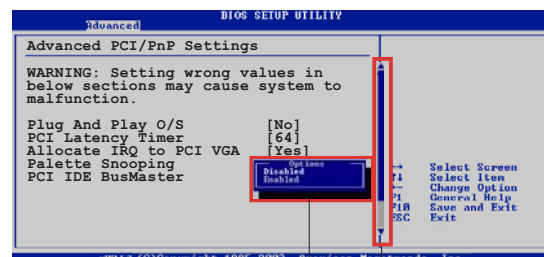

Pop-up window

Scroll bar

## 5.2.9 General help

At the top right corner of the menu screen is a brief description of the selected item.

## 5.3 Main menu

When you enter the BIOS Setup program, the Main menu screen appears, giving you an overview of the basic system information.



Refer to section “5.2.1 BIOS menu screen” for information on the menu screen items and how to navigate through them.

```
BIOS SETUP UTILITY
Main  Advanced  Power  Boot  Exit

System Time           [16:37:21]
System Date           [Fri,05/13/2005]
Legacy Diskette A    [1.44M, 3.5 in.]

▶ IDE Master          : [ST320410A]
▶ IDE Slave           : [ASUS CD-S520/A]
▶ System Information

Use [ENTER], [TAB] or [SHIFT-TAB] to select a field.

Use [+] or [-] to configure the System time.

↔ Select Screen
↑↓ Select Item
+- Change Option
F1  General Help
F10 Save and Exit
ESC Exit

v00.00 (C)Copyright 1985-2003, American Megatrends, Inc.
```

### 5.3.1 System Time [xx:xx:xx]

Allows you to set the system time.

### 5.3.2 System Date [Day xx/xx/xxxx]

Allows you to set the system date.

### 5.3.3 Legacy Diskette A [1.44M, 3.5 in.]

Sets the type of floppy drive installed. Configuration options: [Disabled] [360K, 5.25 in.] [1.2M, 5.25 in.] [720K, 3.5 in.] [1.44M, 3.5 in.] [2.88M, 3.5 in.]



### 5.3.4 IDE Master/Slave

While entering Setup, the BIOS automatically detects the presence of IDE devices. There is a separate sub-menu for each IDE device. Select a device item then press <Enter> to display the IDE device information.

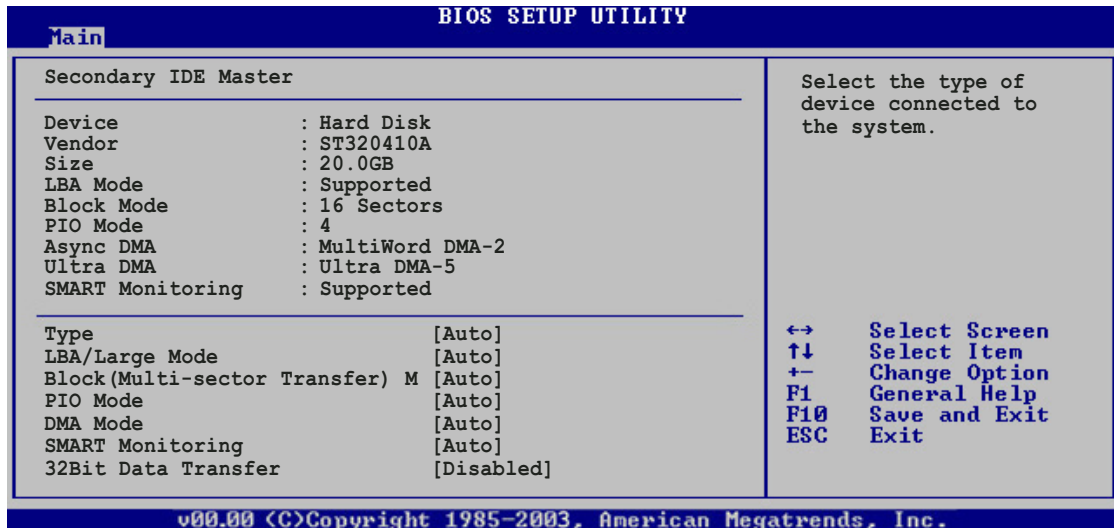

The BIOS automatically detects the values opposite the dimmed items (Device, Vendor, Size, LBA Mode, Block Mode, PIO Mode, Async DMA, Ultra DMA, and SMART monitoring). These values are not user-configurable. These items show N/A if no IDE device is installed in the system.

#### Type [Auto]

Selects the type of IDE drive. Setting to Auto allows automatic selection of the appropriate IDE device type. Select CDROM if you are specifically configuring a CD-ROM drive. Select ARMD (ATAPI Removable Media Device) if your device is either a ZIP, LS-120, or MO drive.

Configuration options: [Not Installed] [Auto] [CDROM] [ARMD]

#### LBA/Large Mode [Auto]

Enables or disables the LBA mode. Setting to Auto enables the LBA mode if the device supports this mode, and if the device was not previously formatted with LBA mode disabled. Configuration options: [Disabled] [Auto]

#### Block (Multi-sector Transfer) [Auto]

Enables or disables data multi-sectors transfers. When set to Auto, the data transfer from and to the device occurs multiple sectors at a time if the device supports multi-sector transfer feature. When set to [Disabled], the data transfer from and to the device occurs one sector at a time.

Configuration options: [Disabled] [Auto]

## PIO Mode [Auto]

Selects the PIO mode.

Configuration options: [Auto] [0] [1] [2] [3] [4]

## DMA Mode [Auto]

Allows you to set the DMA mode. Configuration options: [Auto] [SWDMA0] [SWDMA1] [SWDMA2] [MWDMA0] [MWDMA1] [MWDMA2] [UDMA0] [UDMA1] [UDMA2] [UDMA3] [UDMA4] [UDMA5]

## SMART Monitoring [Auto]

Sets the Smart Monitoring, Analysis, and Reporting Technology.

Configuration options: [Auto] [Disabled] [Enabled]

## 32Bit Data Transfer [Disabled]

Enables or disables 32-bit data transfer.

Configuration options: [Disabled] [Enabled]

## 5.3.5 System Information

This menu gives you an overview of the general system specifications. The BIOS automatically detects the items in this menu.

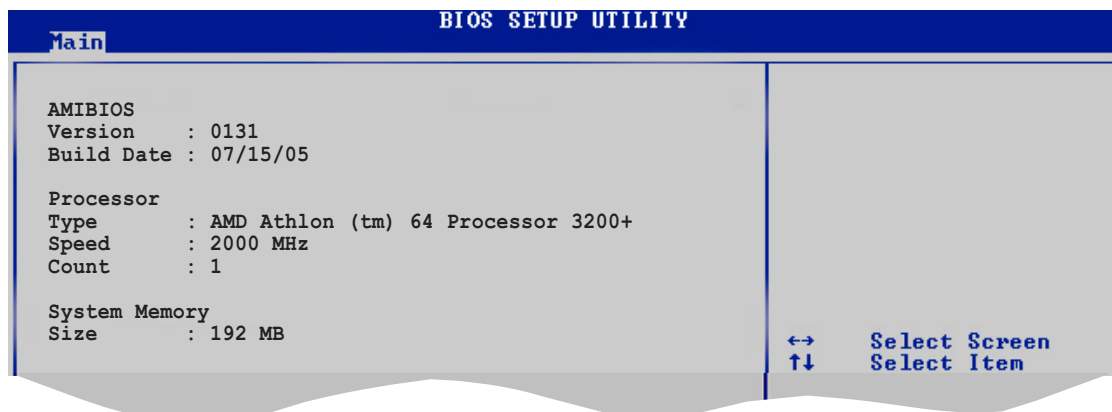

### AMI BIOS

Displays the auto-detected BIOS information.

### Processor

Displays the auto-detected CPU specification.

### System Memory

Displays the auto-detected system memory.

## 5.4 Advanced menu

The Advanced menu items allow you to change the settings for the CPU and other system devices.



Take caution when changing the settings of the Advanced menu items. Incorrect field values can cause the system to malfunction.

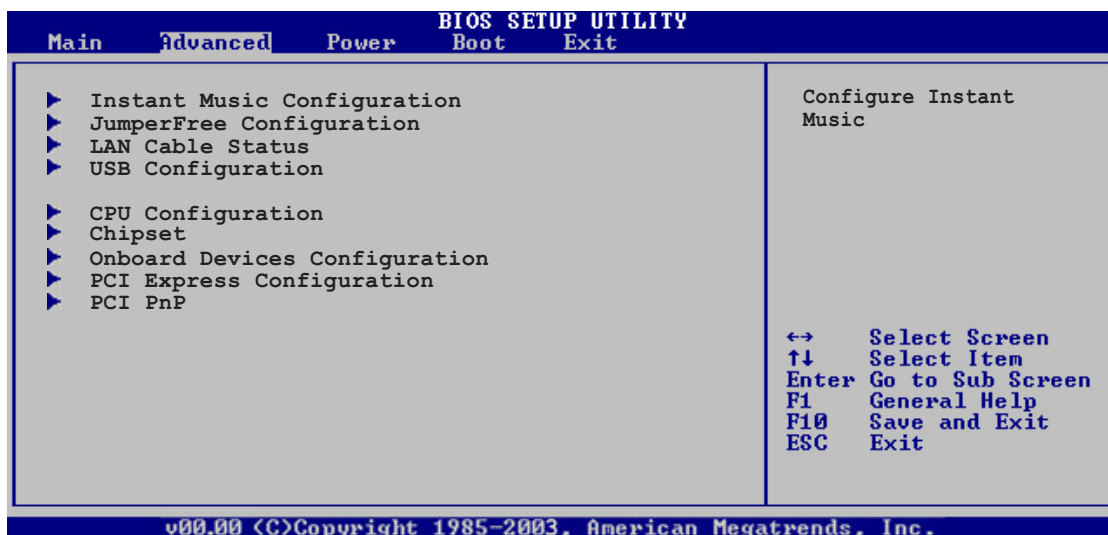

### 5.4.1 Instant Music Configuration

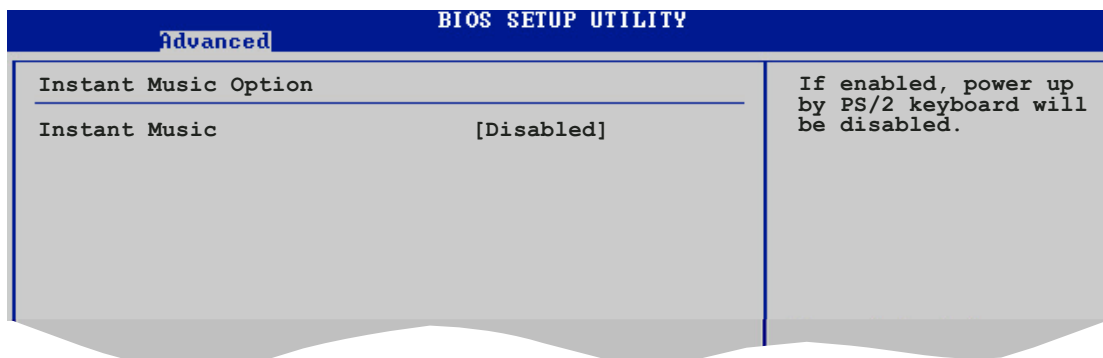

#### Instant Music [Disabled]

Enables or disables the Instant Music feature. Setting this item to [Enabled] disables the power up by PS/2 keyboard function.

Configuration options: [Disabled] [Enabled]



Set the Instant Music item to [Enabled] if you want to enable the ASUS Audio DJ function.



The following items appear when the **Instant Music** item is set to [Enabled].

### Instant Music CD-ROM drive [IDE Secondary Master]

Allows you to configure the Instant Music CD-ROM selection.  
Configuration options: [IDE Primary Master] [IDE Primary Slave]  
[IDE Secondary Master] [IDE Secondary Slave]

### Radio Region [Europe]

Allows you to set the radio region.  
Configuration options: [USA] [Europe] [Japan] [Europe]

## 5.4.2 JumperFree Configuration

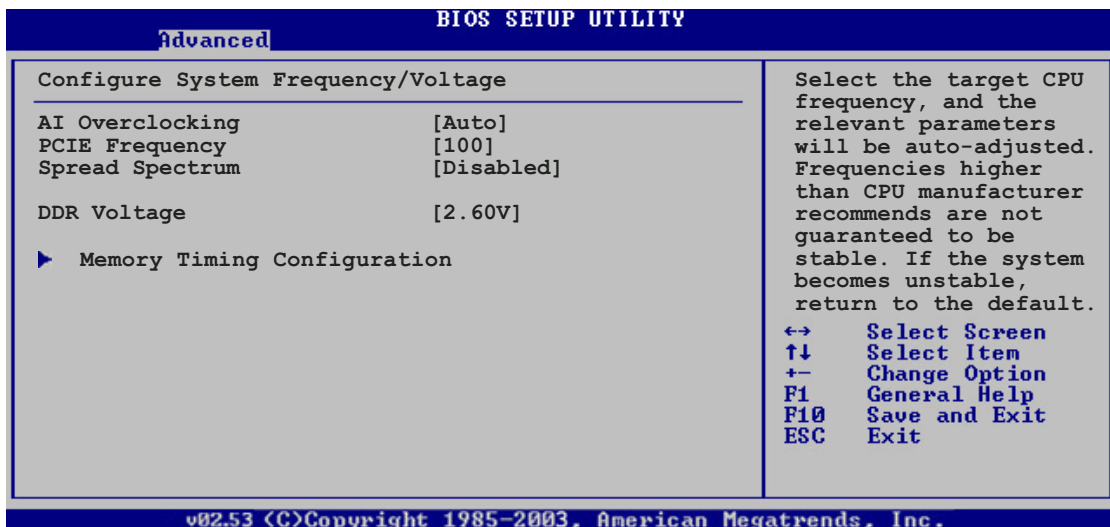

### AI Overclocking [Auto]

Allows you to select the overclocking options to achieve the desired CPU internal frequency. Select either one of the preset overclocking configuration options.

**Manual** - allows you to individually set overclocking parameters.

**Auto** - loads the optimal settings for the system.

**Standard** - loads the standard settings for the system.

**Overclock Profile** - loads overclocking profiles with optimal parameters for stability when overclocking.



---

The following item appears only when you set the **AI Overclocking** item to [Manual].

---

## CPU Frequency [XXX]

Displays the frequency sent by the clock generator to the system bus and PCI bus. The value of this item is auto-detected by the BIOS. Use the <+> and <-> keys to adjust the CPU frequency. You can also type the desired CPU frequency using the numeric keypad. The values range from 100 to 400. Refer to the table below for the correct Front Side Bus and CPU External Frequency settings.

## Overclock Options [Overclock 5%]

Allows you to overclock the CPU speed through the available preset values. Configuration options: [Overclock 5%] [Overclock 10%] [Overclock 15%] [Overclock 20%] [Overclock 30%]



- Support for overclock function depends on your system configuration. ASUS does not guarantee this function for any system configuration.
  - The **Overclock Options** item appears only when the **AI Overclocking** item is set to [Overclock Profile].
- 

## PCIe Frequency [100]

Allows you to set the PCI Express frequency. Use the numeric keypad to enter the value.

## Spread Spectrum [Disabled]

Allows you to enable or disable the clock generator spectrum. Configuration options: [Disabled] [Enabled]

## DDR Voltage [2.60V]

Allows you to set the DDR voltage. Configuration options: [2.60V] [2.70V] [2.80V] [2.90V]

## Memory Timing Configuration



### Memclock Mode [Auto]

Choose [Auto] to allow the BIOS to automatically set the Real Memory Clock Mode. Choose [Limit] to set using one of the standard values.  
Configuration options: [Auto] [Limit]

### **Memclock Value [100 MHz]**

This item appears only if the Memclock Mode item is set to [Limit].  
Configuration options: [100 MHz] [133 MHz] [166 MHz] [183 MHz] [200 MHz] [216 MHz] [233 MHz] [250 MHz]

### MCT Timing Mode [Auto]

Allows you to set the MCT timing mode.  
Configuration options: [Auto] [Manual]

### User Config Mode [Auto]

Allows you to set the user config mode.  
Configuration options: [Auto] [Manual]

### Burst Length [4 Beats]

Allows you to set the burst length.  
Configuration options: [8 Beats] [4 Beats] [2 Beats]

### Hardware Memory Hole [Disabled]

Allows you to enable or disable remapping around the memory hole. This feature is supported only on REV EO or later processors.  
Configuration options: [Disabled] [Enabled]

### 5.4.3 LAN Cable Status

Advanced			BIOS SETUP UTILITY	
POST Check LAN cable		[Disabled]	Check LAN cable during POST.	
LAN Cable Status				
Pair	Status	Length		
1-2	Open	0.0M		
3-6	Open	0.0M		
4-5	Open	0.0M		
7-8	Open	0.0M		
			↔	Select Screen
			↑↓	Select Item
			+ -	Change Option
			F1	General Help
			F10	Save and Exit
			ESC	Exit
v02.53 (C)Copyright 1985-2003, American Megatrends, Inc.				

#### POST Check LAN Cable [Disabled]

Allows you to enable or disable LAN cable check during system POST. When enabled, the menu reports the cable faults or shorts, and displays the point (length) where the fault or short is detected. Configuration options: [Disabled] [Enabled]

## 5.4.4 USB Configuration

The items in this menu allow you to change the USB-related features. Select an item then press <Enter> to display the configuration options.

Advanced		BIOS SETUP UTILITY
USB Configuration		Configure the USB support.
Module Version - 2.24.0-10.4		
USB Devices Enabled: None		
USB Controller	[USB1.1+2.0]	
Legacy USB Support	[Auto]	
USB Wake Up from S5	[Disabled]	
USB 2.0 Controller Mode	[HiSpeed]	
BIOS EHCI Hand-off	[Enabled]	



The **Module Version** and **USB Devices Enabled** items show the auto-detected values. If no USB device is detected, the item shows **None**.

### USB Controller [USB1.1+2.0]

Allows you to select the USB 2.0 controller mode, or disable this function. Configuration options: [Disabled] [USB1.1 only] [USB1.1+2.0]

### Legacy USB Support [Auto]

Allows you to enable or disable support for USB devices on legacy operating systems (OS). Setting to Auto allows the system to detect the presence of USB devices at startup. If detected, the USB controller legacy mode is enabled. If no USB device is detected, the legacy USB support is disabled. Configuration options: [Disabled] [Enabled] [Auto]

### USB Wake Up from S5 [Disabled]

Allows you to enable or disable USB wake-up from S5. When set to [Enabled], you need to unplug the USB device (or plug in a USB device if none is plugged) to avail of this function. Configuration options: [Disabled] [Enabled]

### USB 2.0 Controller Mode [HiSpeed]

Allows you to set the USB 2.0 controller mode to HiSpeed (480 Mbps) or FullSpeed (12 Mbps). Configuration options: [FullSpeed] [HiSpeed]

### BIOS EHCI Hand-off [Enabled]

Allows you to enable or disable the enhanced host controller interface (EHCI) hand-off support. This is a workaround for operating systems without EHCI hand-off support. The EHCI ownership change should be claimed by the EHCI driver. Configuration options: [Disabled] [Enabled]



## 5.4.5 CPU Configuration

The items in this menu show the CPU-related information that the BIOS automatically detects.

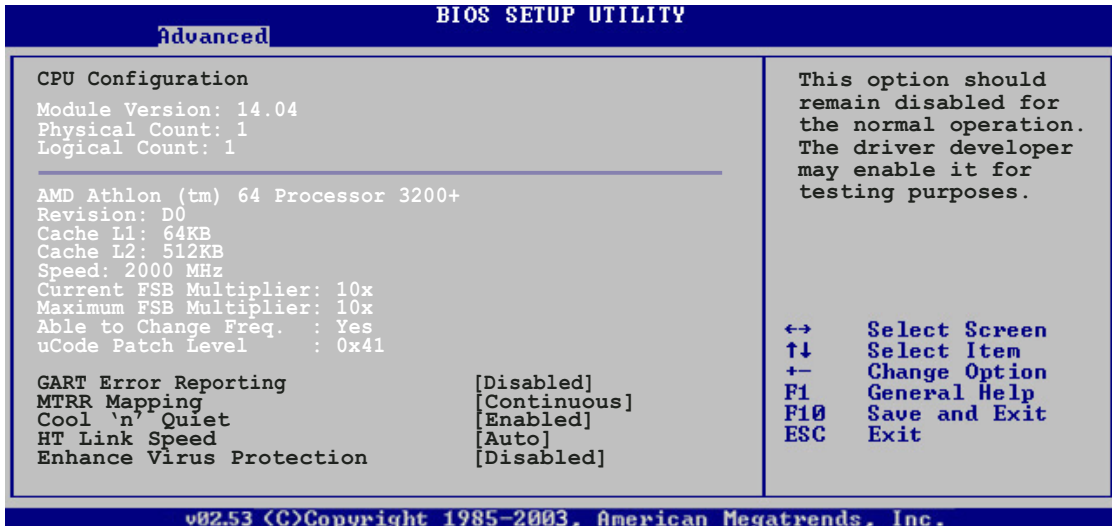

### GART Error Reporting [Disabled]

Set this option to [Disabled] for normal operation.  
Configuration options: [Disabled] [Enabled]

### MTRR Mapping [Continuous]

This option determines the method used for programming CPU MTRRs when 4 GB or more of memory is present. [Discrete] setting leaves the PCI hole below the 4 GB boundary undescribed. [Continuous] explicitly describes the PCI hole as non-cacheable. Configuration options: [Continuous] [Discrete]

### Cool 'n' Quiet [Enabled]

Allows you to enable or disable the AMD Cool 'n' Quiet Technology feature.  
Configuration options: [Disabled] [Enabled]

### HT Link Speed [Auto]

Allows you to set the speed at which the HyperTransport bus will run, if it is slower than or equal to the system clock and if the board is capable.  
Configuration options: [Auto] [200 MHz] [400 MHz] [600 MHz] [800 MHz] [1 GHz]

### Enhance Virus Protection [Disabled]

Allows you to enable or disable the enhanced virus protection feature.  
Configuration options: [Disabled] [Enabled]

## 5.4.6 Chipset

The Chipset menu allows you to change the advanced chipset settings. Select an item then press <Enter> to display the sub-menu.

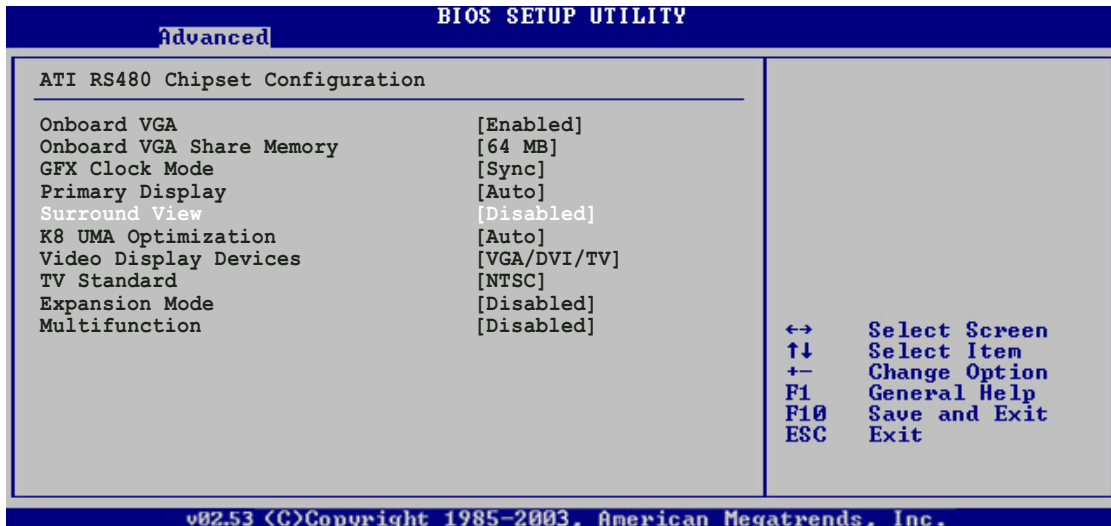

### Onboard VGA [Enabled]

Allows you to enable or disable the onboard VGA.  
Configuration options: [Disabled] Enabled]

### Onboard VGA Share Memory [64 MB]

Configuration options: [16MB] [32MB] [64MB] [128MB]

### GFX Clock Mode [Sync]

GFX MemClock can be synchronous with HyperTransport Link clock or Asynchronous where it is derived from an external clock chip. In Async mode, user can select the clock speed. Configuration options: [Sync] [Async]

### Primary Display [Auto]

Allows you to select the primary display device.  
Configuration option: [Auto] [Internal GFX]

### Surround View [Disabled]

Allows you to enable or disable the surround view.  
Configuration options: [Disabled] [Enabled]

### K8 UMA Optimization [Auto]

Configuration options: [Auto] [Force]

## **Video Display Devices [VGA/DVI/TV]**

Allows you to select the primary video display device.

Configuration options: [VGA/DVI/TV] [DVI/VGA/TV] [TV/VGA/DVI]

## **TV Standard [NTSC]**

Allows you to select the TV standard in your area.

Configuration options: [NTSC] [PAL] [PAL-M] [PAL-60] [NTSC-JAP]  
[PAL-CN] [PAL-N]

## **Expansion Mode [Disabled]**

Allows you to enable or disable text and graphics expansion/central mode selection. Configuration options: [Disabled] [Enabled]

## **Multifunction [Disabled]**

Configuration options: [Disabled] [Enabled]

## 5.4.7 Onboard Devices Configuration

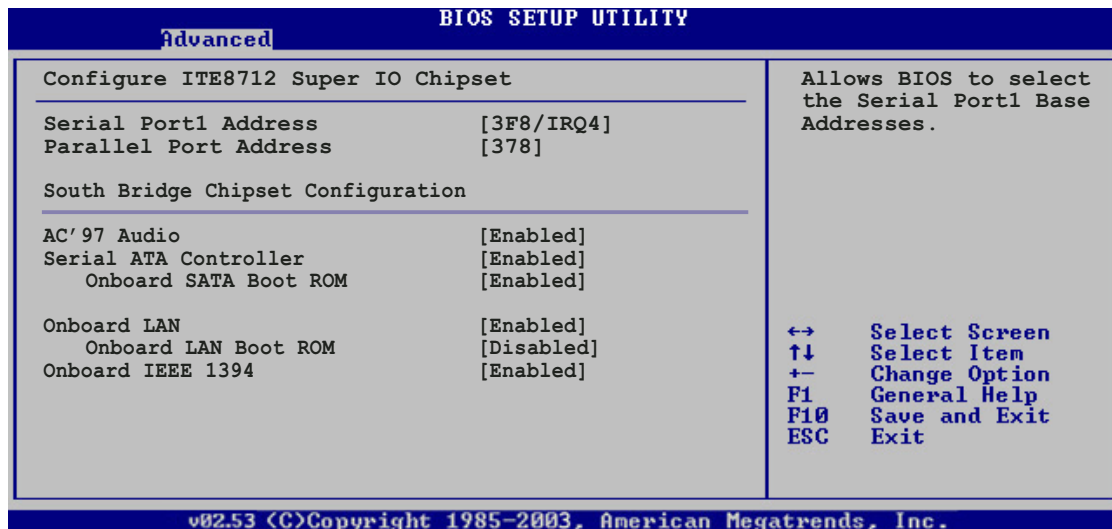

### Serial Port1 Address [3F8/IRQ4]

Allows you to select the Serial Port1 base address.

Configuration options: [Disabled] [3F8/IRQ4] [2F8/IRQ3] [3E8/IRQ4] [2E8/IRQ3]

### Parallel Port Address [378]

Allows you to select the Parallel Port base addresses.

Configuration options: [Disabled] [378] [278] [3BC]

### AC'97 Audio [Enabled]

Allows you to enable or disable the onboard AC`97 audio controller.

Configuration options: [Enabled] [Disabled]

### Serial ATA Controller [Enabled]

Allows you to enable or disable the onboard Serial ATA controller.

Configuration options: [Enabled] [Disabled]

#### *Onboard SATA Boot ROM [Enabled]*

Allows you to enable or disable the onboard Serial ATA boot ROM. This item appears only when the **Serial ATA Controller** is enabled.

Configuration options: [Enabled] [Disabled]

### Onboard LAN [Enabled]

Allows you to enable or disable the onboard LAN.

Configuration options: [Enabled] [Disabled]

#### *Onboard LAN Boot ROM [Enabled]*

Allows you to enable or disable the option ROM in the onboard LAN. This item appears only when the **Onboard LAN** is enabled.

Configuration options: [Enabled] [Disabled]

## Onboard IEEE 1394 [Enabled]

Allows you to enable or disable the onboard IEEE 1394a controller.  
Configuration options: [Enabled] [Disabled]

## 5.4.8 PCI Express Configuration

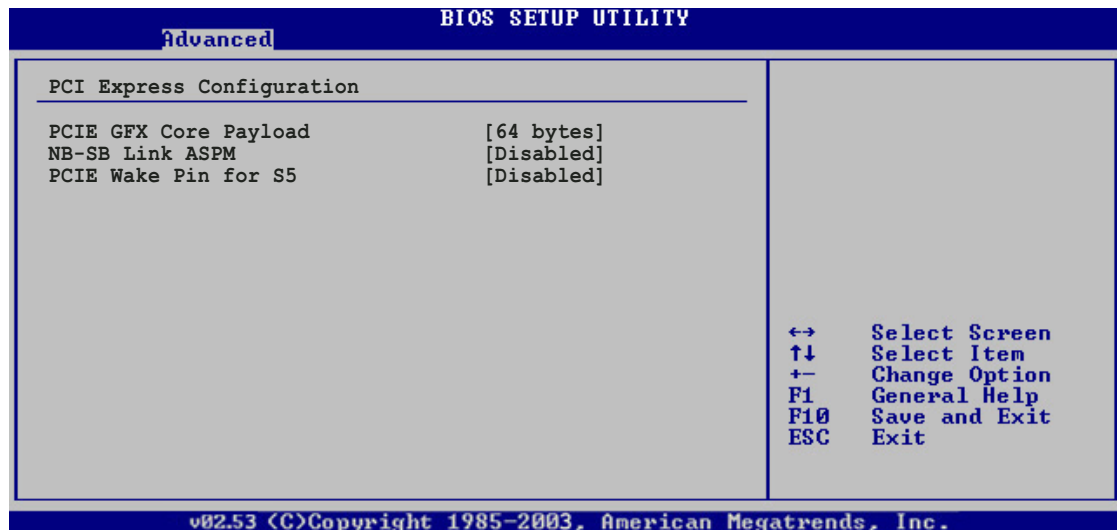

### PCIe GFX Core Payload [64 bytes]

Configuration options: [16 bytes] [32 bytes] [64 bytes]

### NB-SB Link ASPM [Disabled]

Configuration options: [Disabled] [Enabled]

### PCIe Wake Pin for S5 [Disabled]

Configuration options: [Disabled] [Enabled]

## 5.4.9 PCI PnP

The PCI PnP menu items allow you to change the advanced settings for PCI/PnP devices. The menu includes setting IRQ and DMA channel resources for either PCI/PnP or legacy ISA devices, and setting the memory size block for legacy ISA devices.



Take caution when changing the settings of the PCI PnP menu items. Incorrect field values can cause the system to malfunction.

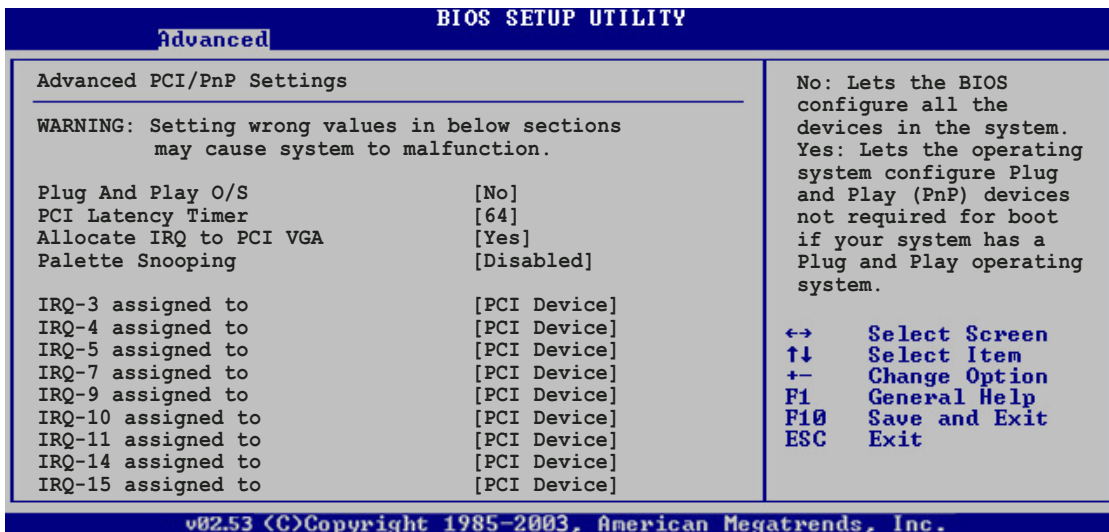

### Plug and Play O/S [No]

When set to [No], BIOS configures all the devices in the system. When set to [Yes] and if you install a Plug and Play operating system, the operating system configures the Plug and Play devices not required for boot. Configuration options: [No] [Yes]

### PCI Latency Timer [64]

Allows you to select the value in units of PCI clocks for the PCI device latency timer register. Configuration options: [32] [64] [96] [128] [160] [192] [224] [248]

### Allocate IRQ to PCI VGA [Yes]

When set to [Yes], BIOS assigns an IRQ to PCI VGA card if the card requests for an IRQ. When set to [No], BIOS does not assign an IRQ to the PCI VGA card even if requested. Configuration options: [Yes] [No]

### Palette Snooping [Disabled]

When set to [Enabled], the palette snooping feature informs the PCI devices that an ISA graphics device is installed in the system so that the latter can function correctly. Configuration options: [Disabled] [Enabled]

## IRQ-xx assigned to [PCI Device]

When set to [PCI Device], the specific IRQ is free for use of PCI/PnP devices. When set to [Reserved], the IRQ is reserved for legacy ISA devices. Configuration options: [PCI Device] [Reserved]

## 5.5 Power menu

The Power menu items allow you to change the settings for the ACPI and Advanced Power Management (APM). Select an item then press <Enter> to display the configuration options.

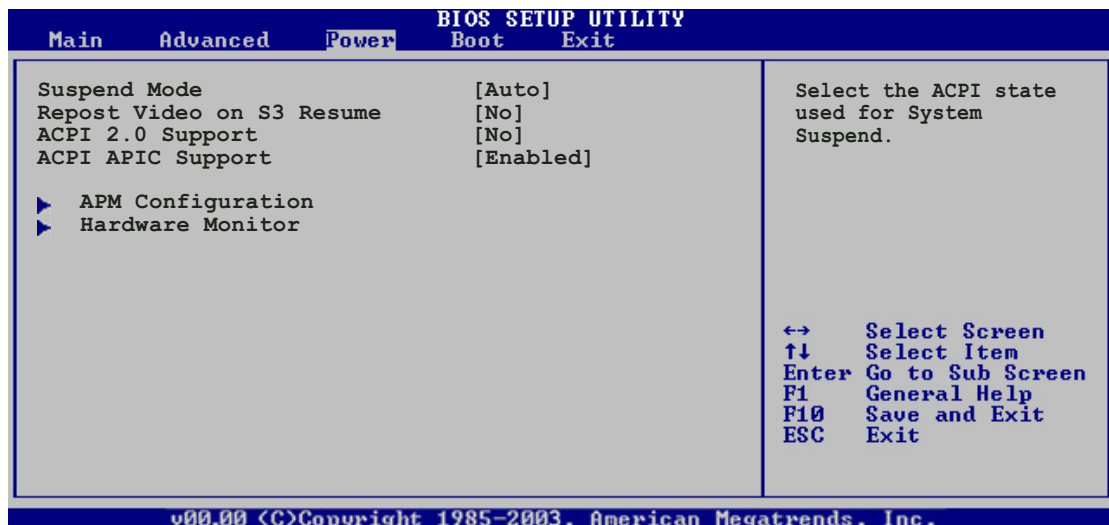

### 5.5.1 Suspend Mode [Auto]

Allows you to select the Advanced Configuration and Power Interface (ACPI) state to be used for system suspend.

Configuration options: [S1 (POS) Only] [S3 Only] [Auto]

### 5.5.2 Repost Video on S3 Resume [No]

Determines whether to invoke VGA BIOS POST on S3/STR resume.

Configuration options: [No] [Yes]

### 5.5.3 ACPI 2.0 Support [No]

Allows you to add more tables for Advanced Configuration and Power Interface (ACPI) 2.0 specifications. Configuration options: [No] [Yes]

### 5.5.4 ACPI APIC Support [Enabled]

Allows you to enable or disable the Advanced Configuration and Power Interface (ACPI) support in the Advanced Programmable Interrupt Controller (APIC). When set to Enabled, the ACPI APIC table pointer is included in the RSDT pointer list. Configuration options: [Disabled] [Enabled]

## 5.5.5 APM Configuration

BIOS SETUP UTILITY	
Power	
APM Configuration	
Power Button Mode	[On/Off]
Restore on AC Power Loss	[Power Off]
Power On By PS/2 Keyboard	[Disabled]
Power On By PS/2 Mouse	[Disabled]
Power On By RTC Alarm	[Disabled]
Power On By External Modems	[Disabled]
Power On By PCI Devices	[Disabled]

### Power Button Mode [On/Off]

Allows the system to go into On/Off mode or suspend mode when the power button is pressed. Configuration options: [On/Off] [Suspend]

### Restore on AC Power Loss [Power Off]

When set to Power Off, the system goes into off state after an AC power loss. When set to Power On, the system goes on after an AC power loss. When set to Last State, the system goes into either off or on state, whatever the system state was before the AC power loss. Configuration options: [Power Off] [Power On] [Last State]

### Power On By PS/2 Keyboard [Disabled]

Allows you to use specific keys on the keyboard to turn on the system. This feature requires an ATX power supply that provides at least 1A on the +5VSB lead. Configuration options: [Disabled] [Enabled]

### Power On By PS/2 Mouse [Disabled]

When set to [Enabled], this parameter allows you to use the PS/2 mouse to turn on the system. This feature requires an ATX power supply that provides at least 1A on the +5VSB lead. Configuration options: [Disabled] [Enabled]



## **Power On By RTC Alarm [Disabled]**

Allows you to enable or disable RTC to generate a wake event. When this item is set to Enabled, the items RTC Alarm Date, RTC Alarm Hour, RTC Alarm Minute, and RTC Alarm Second appear with set values. Configuration options: [Disabled] [Enabled]

## **Power On By External Modems [Disabled]**

This allows either settings of [Enabled] or [Disabled] for powering up the computer when the external modem receives a call while the computer is in Soft-off mode. Configuration options: [Disabled] [Enabled]



---

The computer cannot receive or transmit data until the computer and applications are fully running. Thus, connection cannot be made on the first try. Turning an external modem off and then back on while the computer is off causes an initialization string that turns the system on.

---

## **Power On By PCI Devices [Disabled]**

When set to [Enabled], this parameter allows you to turn on the system through a PCI LAN, modem card, or PCI Express device. This feature requires an ATX power supply that provides at least 1A on the +5VSB lead. Configuration options: [Disabled] [Enabled]

## 5.5.6 Hardware Monitor

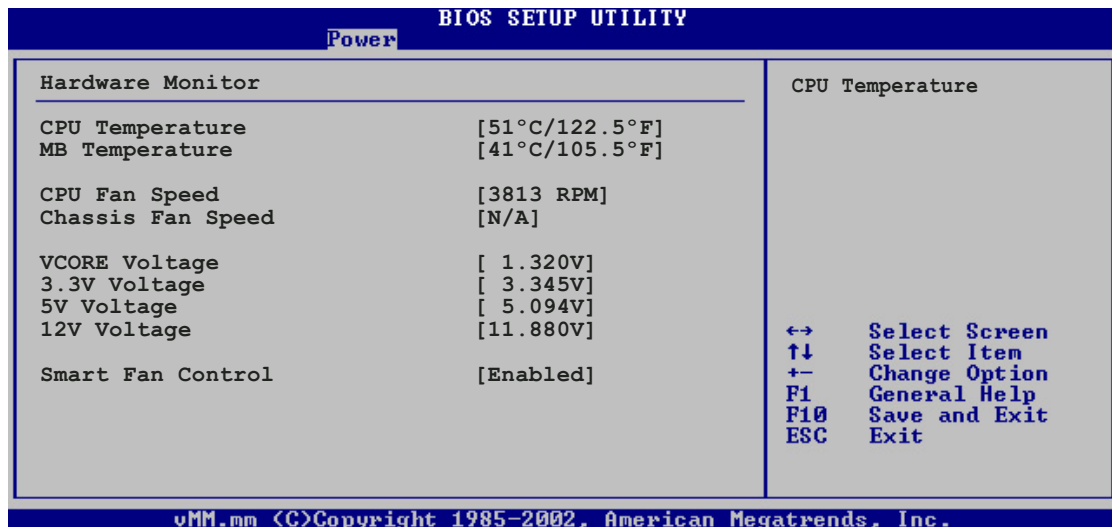

### **CPU Temperature [xxx°C/xxx°F] MB Temperature [xxx°C/xxx°F]**

The onboard hardware monitor automatically detects and displays the motherboard and CPU temperatures. Select Disabled if you do not wish to display the detected temperatures.

### **CPU Fan Speed [xxxxRPM], [N/A], or [Ignored]**

The onboard hardware monitor automatically detects and displays the CPU fan speed in rotations per minute (RPM). If the fan is not connected to the motherboard, the field shows N/A.

### **Chassis Fan Speed [xxxxRPM], [N/A], or [Ignored]**

The onboard hardware monitor automatically detects and displays the chassis fan speed in rotations per minute (RPM). If the fan is not connected to the chassis, the specific field shows N/A.

### **VCORE Voltage, 3.3V Voltage, 5V Voltage, 12V Voltage**

The onboard hardware monitor automatically detects the voltage output through the onboard voltage regulators.

### **Smart Fan Control [Enabled]**

Allows you to enable or disable the ASUS Smart Fan Control feature that smartly adjusts the fan speeds for more efficient system operation.  
Configuration options: [Disabled] [Enabled]

## 5.6 Boot menu

The Boot menu items allow you to change the system boot options. Select an item then press <Enter> to display the sub-menu.

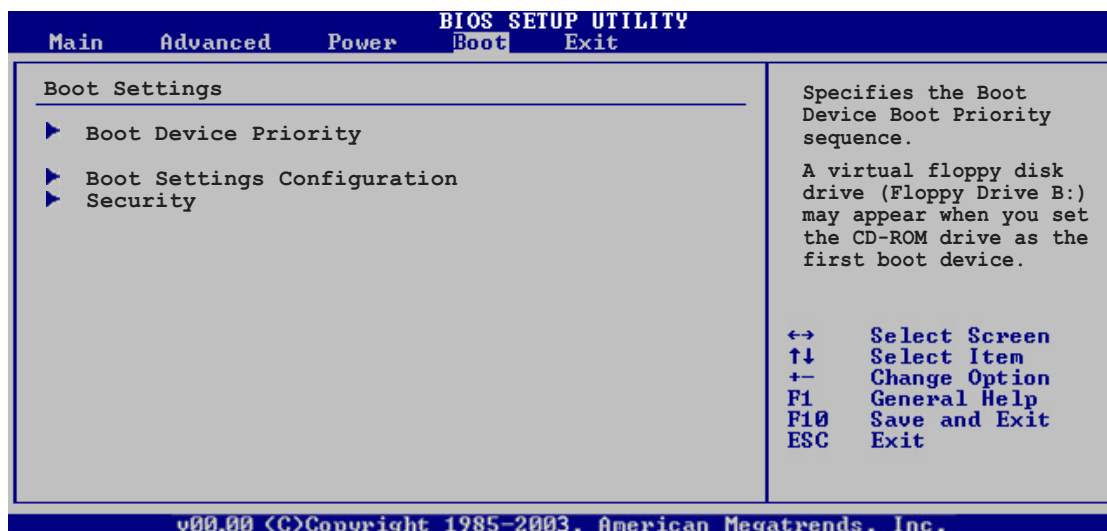

### 5.6.1 Boot Device Priority

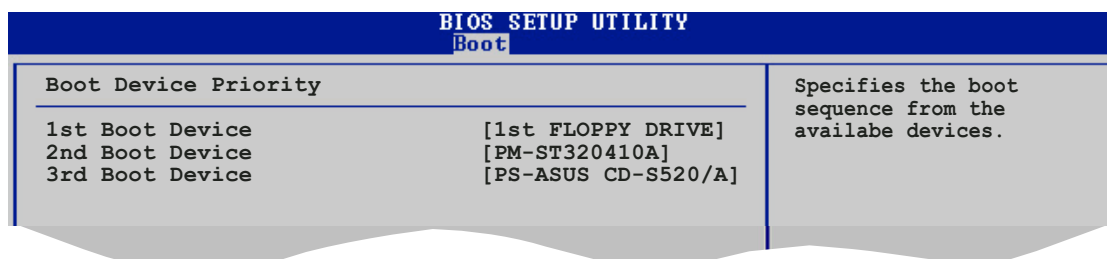

#### 1st ~ xxth Boot Device [1st Floppy Drive]

These items specify the boot device priority sequence from the available devices. The number of device items that appears on the screen depends on the number of devices installed in the system.

Configuration options: [xxxxx Drive] [Disabled]

## 5.6.2 Boot Settings Configuration

BIOS SETUP UTILITY	
Boot	
Boot Settings Configuration	
Quick Boot	[Enabled]
AddOn ROM Display Mode	[Force BIOS]
Bootup Num-Lock	[On]
PS/2 Mouse Support	[Auto]
Wait For 'F1' If Error	[Enabled]
Hit 'DEL' Message Display	[Enabled]
Interrupt 19 Capture	[Disabled]

Allows BIOS to skip certain tests while booting. This will decrease the time needed to boot the system.

### Quick Boot [Enabled]

Enabling this item allows the BIOS to skip some power on self tests (POST) while booting to decrease the time needed to boot the system. When set to [Disabled], BIOS performs all the POST items.

Configuration options: [Disabled] [Enabled]

### Add On ROM Display Mode [Force BIOS]

Sets the display mode for option ROM.

Configuration options: [Force BIOS] [Keep Current]

### Bootup Num-Lock [On]

Allows you to select the power-on state for the NumLock.

Configuration options: [Off] [On]

### PS/2 Mouse Support [Auto]

Allows you to enable or disable support for PS/2 mouse.

Configuration options: [Disabled] [Enabled] [Auto]

### Wait for 'F1' If Error [Enabled]

When set to Enabled, the system waits for the F1 key to be pressed when error occurs. Configuration options: [Disabled] [Enabled]

### Hit 'DEL' Message Display [Enabled]

When set to Enabled, the system displays the message "Press DEL to run Setup" during POST. Configuration options: [Disabled] [Enabled]

### Interrupt 19 Capture [Disabled]

When set to [Enabled], this function allows the option ROMs to trap Interrupt 19. Configuration options: [Disabled] [Enabled]

### 5.6.3 Security

The Security menu items allow you to change the system security settings. Select an item then press <Enter> to display the configuration options.

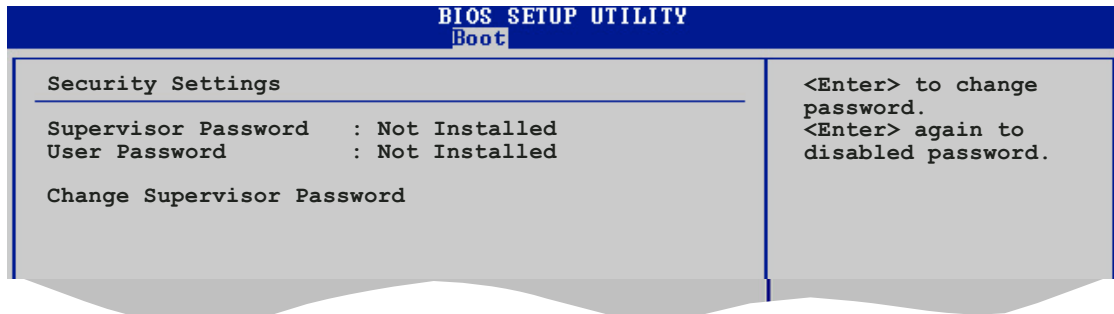

#### Change Supervisor Password

Select this item to set or change the supervisor password. The Supervisor Password item on top of the screen shows the default **Not Installed**. After you set a password, this item shows **Installed**.

To set a Supervisor Password:

1. Select the Change Supervisor Password item and press <Enter>.
2. From the password box, type a password composed of at least six letters and/or numbers, then press <Enter>.
3. Confirm the password when prompted.

The message "Password Installed" appears after you successfully set your password.

To change the supervisor password, follow the same steps as in setting a user password.

To clear the supervisor password, select the Change Supervisor Password then press <Enter>. The message "Password Uninstalled" appears.



If you forget your BIOS password, you can clear it by erasing the CMOS Real Time Clock (RTC) RAM. See section “4.3 Jumpers” for information on how to erase the RTC RAM.

After you have set a supervisor password, the other items appear to allow you to change other security settings.

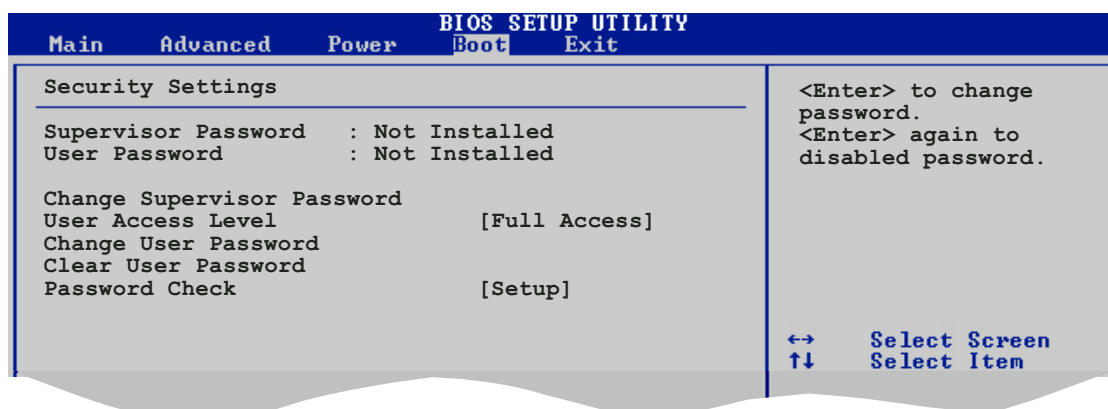

## User Access Level (Full Access]

This item allows you to select the access restriction to the Setup items. Configuration options: [No Access] [View Only] [Limited] [Full Access]

**No Access** prevents user access to the Setup utility.

**View Only** allows access but does not allow change to any field.

**Limited** allows changes only to selected fields, such as Date and Time.

**Full Access** allows viewing and changing all the fields in the Setup utility.

## Change User Password

Select this item to set or change the user password. The User Password item on top of the screen shows the default **Not Installed**. After you set a password, this item shows **Installed**.

To set a User Password:

1. Select the Change User Password item and press <Enter>.
2. On the password box that appears, type a password composed of at least six letters and/or numbers, then press <Enter>.
3. Confirm the password when prompted.

The message “Password Installed” appears after you set your password successfully.

To change the user password, follow the same steps as in setting a user password.

## Clear User Password

Select this item to clear the user password.

## Password Check [Setup]

When set to [Setup], BIOS checks for user password when accessing the Setup utility. When set to [Always], BIOS checks for user password both when accessing Setup and booting the system.

Configuration options: [Setup] [Always]

## 5.7 Exit menu

The Exit menu items allow you to load the optimal or failsafe default values for the BIOS items, and save or discard your changes to the BIOS items.

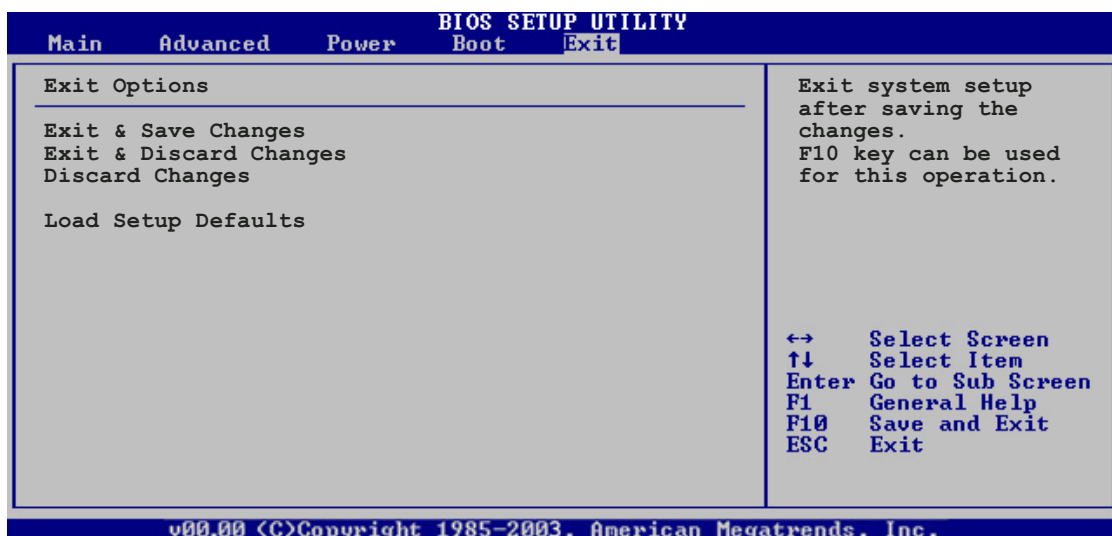

Pressing <Esc> does not immediately exit this menu. Select one of the options from this menu or <F10> from the legend bar to exit.

## Exit & Save Changes

Once you are finished making your selections, choose this option from the Exit menu to ensure the values you selected are saved to the CMOS RAM. An onboard backup battery sustains the CMOS RAM so it stays on even when the PC is turned off. When you select this option, a confirmation window appears. Select **[Ok]** to save changes and exit.



---

If you attempt to exit the Setup program without saving your changes, the program prompts you with a message asking if you want to save your changes before exiting. Press <Enter> to save the changes while exiting.

---

## Exit & Discard Changes

Select this option only if you do not want to save the changes that you made to the Setup program. If you made changes to fields other than System Date, System Time, and Password, the BIOS asks for a confirmation before exiting.

## Discard Changes

This option allows you to discard the selections you made and restore the previously saved values. After selecting this option, a confirmation appears. Select **[Ok]** to discard any changes and load the previously saved values.

## Load Setup Defaults

This option allows you to load the default values for each of the parameters on the Setup menus. When you select this option or if you press <F5>, a confirmation window appears. Select **[Ok]** to load default values. Select **Exit & Save Changes** or make other changes before saving the values to the non-volatile RAM.



# Appendix

The Appendix includes the power supply unit specification for this system.

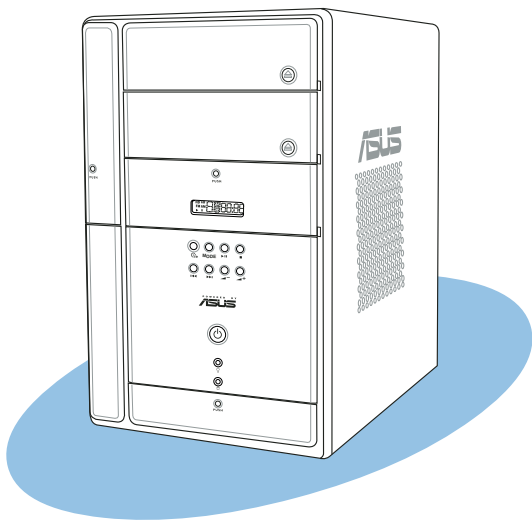

ASUS T2-AH1

# Power supply specifications

## Input characteristics

Input Voltage Range	Min	Nom	Max
Range 1	90 V	115 V	132 V
Range 2	180 V	230 V	264 V
<b>Input Frequency Range</b>	47 Hz to 63 Hz		
<b>Maximum Input AC Current</b>	5 A max. at 115 Vac 3 A max. at 230 Vac, full load		
<b>Inrush Current</b>	No hazards to occur and damage components		
<b>Efficiency</b>	65% min. at 115Vac and output full load		
<b>Current Harmonic</b>	Meets EN61000-3-2 @ 100 Vac/50 Hz or 230 Vac/50 Hz at full load		
<b>EPA</b>	50% min. at input 115 Vac, 60 Hz		

## Output characteristics

Output Voltage	Load Range		Regulation		Ripple
	Min	Max	Min	Max	Max
+5 V	1.5 A	16 A	-5%	+5%	50 mVp-p
+12 V	0.5 A	16 A	-5%	+5%	120 mVp-p
-12 V	0.05 A	0.8 A	-10%	+10%	150 mVp-p
+3.3 V	0.3 A	16 A	-5%	+5%	60 mVp-p
+5 VSB	0.01 A	2 A	-5%	+5%	60 mVp-p

## Over-Voltage Protection (OVP)

Output Voltage	Maximum Voltage
+3.3V	4.6V
+5V	6.5V
+12V	15.6V