

# ASUS<sup>®</sup>

# T-P5G31

*ASUS PC (Desktop Barebone)*

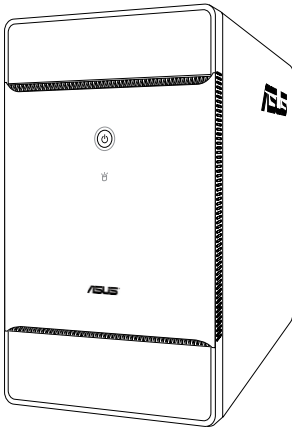

**T3-P5G31**

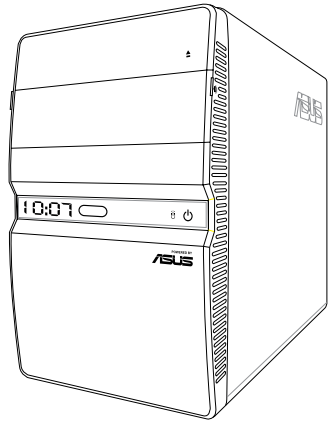

**T4-P5G31\***

\* Only some of the T4 models have the Time and IR LED display.

E3630

First Edition

March 2008

**Copyright © 2008 ASUSTeK COMPUTER INC. All Rights Reserved.**

No part of this manual, including the products and software described in it, may be reproduced, transmitted, transcribed, stored in a retrieval system, or translated into any language in any form or by any means, except documentation kept by the purchaser for backup purposes, without the express written permission of ASUSTeK COMPUTER INC. ("ASUS").

Product warranty or service will not be extended if: (1) the product is repaired, modified or altered, unless such repair, modification or alteration is authorized in writing by ASUS; or (2) the serial number of the product is defaced or missing.

ASUS PROVIDES THIS MANUAL "AS IS" WITHOUT WARRANTY OF ANY KIND, EITHER EXPRESS OR IMPLIED, INCLUDING BUT NOT LIMITED TO THE IMPLIED WARRANTIES OR CONDITIONS OF MERCHANTABILITY OR FITNESS FOR A PARTICULAR PURPOSE. IN NO EVENT SHALL ASUS, ITS DIRECTORS, OFFICERS, EMPLOYEES OR AGENTS BE LIABLE FOR ANY INDIRECT, SPECIAL, INCIDENTAL, OR CONSEQUENTIAL DAMAGES (INCLUDING DAMAGES FOR LOSS OF PROFITS, LOSS OF BUSINESS, LOSS OF USE OR DATA, INTERRUPTION OF BUSINESS AND THE LIKE), EVEN IF ASUS HAS BEEN ADVISED OF THE POSSIBILITY OF SUCH DAMAGES ARISING FROM ANY DEFECT OR ERROR IN THIS MANUAL OR PRODUCT.

SPECIFICATIONS AND INFORMATION CONTAINED IN THIS MANUAL ARE FURNISHED FOR INFORMATIONAL USE ONLY, AND ARE SUBJECT TO CHANGE AT ANY TIME WITHOUT NOTICE, AND SHOULD NOT BE CONSTRUED AS A COMMITMENT BY ASUS. ASUS ASSUMES NO RESPONSIBILITY OR LIABILITY FOR ANY ERRORS OR INACCURACIES THAT MAY APPEAR IN THIS MANUAL, INCLUDING THE PRODUCTS AND SOFTWARE DESCRIBED IN IT.

Products and corporate names appearing in this manual may or may not be registered trademarks or copyrights of their respective companies, and are used only for identification or explanation and to the owners' benefit, without intent to infringe.

# Contents

Notices.....	vi
Safety information .....	vii
About this guide .....	viii
System package contents.....	x

## Chapter 1: System introduction

1.1	Welcome! .....	1-2
1.2	Front panel .....	1-2
	1.2.1 T3-P5G31 front panel .....	1-2
	1.2.2 T4-P5G31 front panel .....	1-4
1.3	Rear panel.....	1-6
1.4	Internal components.....	1-8

## Chapter 2: Basic installation

2.1	Preparation .....	2-2
2.2	Before you proceed .....	2-2
2.3	Removing the cover.....	2-3
2.4	Power supply unit .....	2-4
2.5	CPU installation.....	2-5
	2.5.1 Installing the CPU .....	2-5
	2.5.2 Installing CPU fan and heatsink assembly.....	2-7
2.6	Installing a DIMM.....	2-8
	2.6.1 Memory configurations.....	2-8
	2.6.2 DIMM installation .....	2-11
2.7	Installing an expansion card.....	2-12
	2.7.1 Expansion slots.....	2-12
	2.7.2 Expansion card installation .....	2-13
2.8	Installing an optical drive .....	2-14
2.9	Installing a Serial ATA disk drive .....	2-15
2.10	Replacing the power supply unit.....	2-16
2.11	Replacing the cover .....	2-17

## Chapter 3: Starting up

3.1	Installing an operating system .....	3-2
3.2	Powering up.....	3-2
3.3	Support CD information .....	3-3
	3.3.1 Running the support CD .....	3-3

# Contents

- 3.3.2 Drivers menu..... 3-4
- 3.3.3 Utilities menu ..... 3-5
- 3.3.4 ASUS contact information..... 3-6

## Chapter 4: Motherboard info

- 4.1 Introduction ..... 4-2
- 4.2 Motherboard layout..... 4-2
- 4.3 Jumpers ..... 4-3
- 4.4 Connectors ..... 4-5

## Chapter 5: BIOS setup

- 5.1 Managing and updating your BIOS ..... 5-2
  - 5.1.1 Creating a bootable floppy disk..... 5-2
  - 5.1.2 ASUS EZ Flash 2 utility..... 5-3
  - 5.1.3 AFUDOS utility..... 5-4
  - 5.1.4 ASUS CrashFree BIOS 3 utility ..... 5-6
  - 5.1.5 ASUS Update utility ..... 5-8
- 5.2 BIOS setup program ..... 5-11
  - 5.2.1 BIOS menu screen..... 5-12
  - 5.2.2 Menu bar..... 5-12
  - 5.2.3 Navigation keys..... 5-12
  - 5.2.4 Menu items ..... 5-13
  - 5.2.5 Sub-menu items..... 5-13
  - 5.2.6 Configuration fields ..... 5-13
  - 5.2.7 Pop-up window ..... 5-13
  - 5.2.8 Scroll bar..... 5-13
  - 5.2.9 General help ..... 5-13
- 5.3 Main menu ..... 5-14
  - 5.3.1 System Time ..... 5-14
  - 5.3.2 System Date ..... 5-14
  - 5.3.3 Primary IDE Master/Slave, SATA1~3..... 5-15
  - 5.3.4 IDE Configuration..... 5-16
  - 5.3.5 System Information ..... 5-17
- 5.4 Advanced menu ..... 5-18
  - 5.4.1 CPU Configuration ..... 5-19
  - 5.4.2 Chipset..... 5-21

# Contents

5.4.3	Onboard Devices Configuration .....	5-23
5.4.4	PCI PnP .....	5-24
5.4.5	USB Configuration .....	5-25
<b>5.5</b>	<b>Power menu .....</b>	<b>5-27</b>
5.5.1	Suspend Mode .....	5-27
5.5.2	ACPI 2.0 Support .....	5-27
5.5.3	ACPI APIC Support .....	5-27
5.5.4	APM Configuration .....	5-28
5.5.5	Hardware Monitor .....	5-30
<b>5.6</b>	<b>Boot menu .....</b>	<b>5-31</b>
5.6.1	Boot Device Priority .....	5-31
5.6.2	Boot Settings Configuration .....	5-32
5.6.3	Security .....	5-33
<b>5.7</b>	<b>Tools menu .....</b>	<b>5-35</b>
5.7.1	ASUS EZ Flash 2 .....	5-35
5.7.2	Turn On/Off LED Timer Display .....	5-35
5.7.3	LED Poster Backlight .....	5-35
<b>5.8</b>	<b>Exit menu .....</b>	<b>5-36</b>
 <b>Appendix</b>		
<b>A.1</b>	<b>Power supply specifications .....</b>	<b>A-2</b>
<b>A.2</b>	<b>Debug code table .....</b>	<b>A-2</b>
<b>A.3</b>	<b>Using the Remote Control (optional) .....</b>	<b>A-3</b>

# Notices

## Federal Communications Commission Statement

This device complies with Part 15 of the FCC Rules. Operation is subject to the following two conditions:

- This device may not cause harmful interference, and
- This device must accept any interference received including interference that may cause undesired operation.

This equipment has been tested and found to comply with the limits for a Class B digital device, pursuant to Part 15 of the FCC Rules. These limits are designed to provide reasonable protection against harmful interference in a residential installation. This equipment generates, uses and can radiate radio frequency energy and, if not installed and used in accordance with manufacturer's instructions, may cause harmful interference to radio communications. However, there is no guarantee that interference will not occur in a particular installation. If this equipment does cause harmful interference to radio or television reception, which can be determined by turning the equipment off and on, the user is encouraged to try to correct the interference by one or more of the following measures:

- Reorient or relocate the receiving antenna.
- Increase the separation between the equipment and receiver.
- Connect the equipment to an outlet on a circuit different from that to which the receiver is connected.
- Consult the dealer or an experienced radio/TV technician for help.



---

The use of shielded cables for connection of the monitor to the graphics card is required to assure compliance with FCC regulations. Changes or modifications to this unit not expressly approved by the party responsible for compliance could void the user's authority to operate this equipment.

---

## Canadian Department of Communications Statement

This digital apparatus does not exceed the Class B limits for radio noise emissions from digital apparatus set out in the Radio Interference Regulations of the Canadian Department of Communications.

**This class B digital apparatus complies with Canadian ICES-003.**

## Macrovision Corporation Product Notice

This product incorporates copyright protection technology that is protected by U.S. patents and other intellectual property rights. Use of this copyright protection technology must be authorized by Macrovision, and is intended for home and other limited viewing uses only unless otherwise authorized by Macrovision. Reverse engineering or disassembly is prohibited.

# Safety information

## Electrical safety

- To prevent electrical shock hazard, disconnect the power cable from the electrical outlet before relocating the system.
- When adding or removing devices to or from the system, ensure that the power cables for the devices are unplugged before the signal cables are connected.
- If the power supply is broken, do not try to fix it by yourself. Contact a qualified service technician or your retailer.

## Operation safety

- Before installing devices into the system, carefully read all the documentation that came with the package.
- Before using the product, ensure that all cables are correctly connected and the power cables are not damaged. If you detect any damage, contact your dealer immediately.
- To avoid short circuits, keep paper clips, screws, and staples away from connectors, slots, sockets and circuitry.
- Avoid dust, humidity, and temperature extremes. Do not place the product in any area where it may become wet. Place the product on a stable surface.
- When using the product, do not block any air inlet/outlet in the chassis.
- The maximum environmental temperature is 35°C.
- If you encounter technical problems with the product, contact a qualified service technician or your retailer.

### ***Lithium-Ion Battery Warning***

**CAUTION:** Danger of explosion if battery is incorrectly replaced. Replace only with the same or equivalent type recommended by the manufacturer. Dispose of used batteries according to the manufacturer's instructions.

**VORSICHT:** Explosionsgefahr bei unsachgemäßen Austausch der Batterie. Ersatz nur durch denselben oder einem vom Hersteller empfohlenem ähnlichen Typ. Entsorgung gebrauchter Batterien nach Angaben des Herstellers.

### ***LASER PRODUCT WARNING***

**CLASS 1 LASER PRODUCT**

# About this guide

## Audience

This guide provides general information and installation instructions about ASUS T-P5G31 barebone system. This guide is intended for experienced users and integrators with hardware knowledge of personal computers.

## How this guide is organized

This guide contains the following parts:

### 1. Chapter 1: System introduction

This chapter gives a general description of ASUS T-P5G31. The chapter lists the system features, including introduction on the front and rear panel, and internal components.

### 2. Chapter 2: Basic installation

This chapter provides step-by-step instructions on how to install components in the system.

### 3. Chapter 3: Starting up

This chapter helps you power up the system and install drivers and utilities from the support CD.

### 4. Chapter 4: Motherboard information

This chapter gives information about the motherboard that comes with the system. This chapter includes the motherboard layout, jumper settings, and connector locations.

### 5. Chapter 5: BIOS information

This chapter tells how to change system settings through the BIOS Setup menus and describes the BIOS parameters.

### 6. Appendix

The Appendix includes the power supply unit specification for this system.



## Conventions used in this guide



**WARNING:** Information to prevent injury to yourself when trying to complete a task.



**CAUTION:** Information to prevent damage to the components when trying to complete a task.



**IMPORTANT:** Instructions that you **MUST** follow to complete a task.



**NOTE:** Tips and additional information to aid in completing a task.

## Where to find more information

Refer to the following sources for additional information and for product and software updates.

### 1. **ASUS Websites**

The ASUS websites worldwide provide updated information on ASUS hardware and software products. Refer to the ASUS contact information.

### 2. **Optional Documentation**

Your product package may include optional documentation, such as warranty flyers, that may have been added by your dealer. These documents are not part of the standard package.

# System package contents

Check your T-P5G31 system package for the following items.



If any of the items is damaged or missing, contact your retailer immediately.

Item description
<b>1. ASUS T-P5G31 barebone system with</b>
<ul style="list-style-type: none"><li>• ASUS motherboard</li></ul>
<ul style="list-style-type: none"><li>• 250 W PFC power supply unit</li></ul>
<ul style="list-style-type: none"><li>• Front I/O card</li></ul>
<ul style="list-style-type: none"><li>• 6-in-1 storage card reader</li></ul>
<b>2. Cables</b>
<ul style="list-style-type: none"><li>• AC power cord</li></ul>
<ul style="list-style-type: none"><li>• ATA cable</li></ul>
<ul style="list-style-type: none"><li>• Serial ATA cable</li></ul>
<ul style="list-style-type: none"><li>• Serial ATA power cable</li></ul>
<b>3. Support CD and Software CD</b>
<b>4. Installation Manual</b>
<b>5. Optional items</b>
<ul style="list-style-type: none"><li>• Telephone Adapter card</li></ul>
<ul style="list-style-type: none"><li>• Remote control</li></ul>

# Chapter 1

This chapter gives a general description of ASUS T-P5G31. The chapter lists the system features including introduction on the front and rear panel, and internal components.

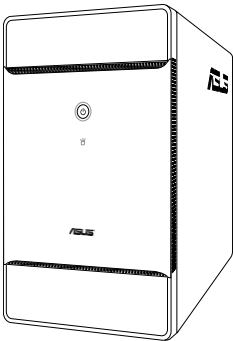

**T3-P5G31**

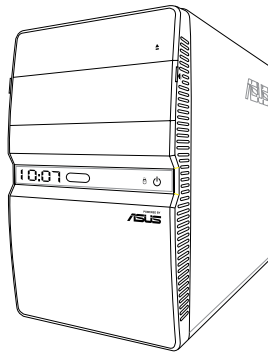

**T4-P5G31\***

\* Only some of the T4 models have the Time and IR LED display.

# 1.1 Welcome!

Thank you for buying an ASUS T-P5G31!

ASUS T-P5G31 is an all-in-one barebone system with a versatile home entertainment feature.

The system comes in a stylish mini-tower casing, and powered by an ASUS motherboard that supports the Intel® Pentium® 4 processor in the 775-land package with 800/1066/1333 MHz FSB and up to 4 GB system memory.

With audio functions, extensive connectivity, and Gigabit LAN capability, the T-P5G31 is designed for the sophisticated.



With these and many more, the T-P5G31 definitely delivers the cutting edge technology for your computing and multimedia needs!

## 1.2 Front panel



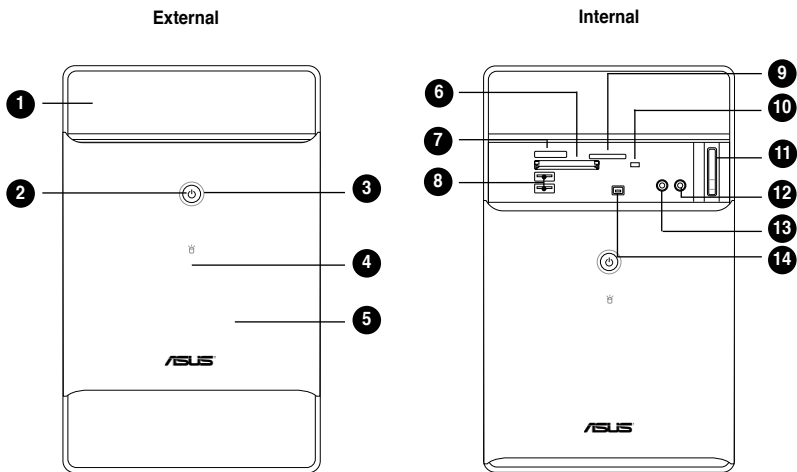



The front panel includes the system control button, system LEDs, and LED panel. The storage card reader slots, and several I/O ports are located inside the frontpanel cover.

### 1.2.1 T3-P5G31 front panel



1. **Drive door.** Open this door to access the optical drive.
2. **Power button** . Press this button to turn the system on/off.
3. **HDD LED** . This LED lights up when data is being read from or written to the hard disk drive. (for Black Bezel)
4. **HDD LED** . This LED lights up when data is being read from or written to the hard disk drive. (for Silver Bezel)
5. **Front panel I/O cover.** Open the front panel cover to show the input/output ports.

Open the front panel cover by pushing it downwards.

6. **CompactFlash®/Microdrive™ card slot** . This slot is for a CompactFlash®/Microdrive™ storage card.
7. **Memory Stick®/Memory Stick Pro™ card slot.** This slot is for a Memory Stick®/Memory Stick Pro™ storage card.
8. **USB 2.0 ports**  **2.0.** These Universal Serial Bus 2.0 (USB 2.0) ports are available for connecting USB 2.0 devices such as a mouse, printer, scanner, camera, PDA, and others.
9. **Secure Digital™/MultimediaCard slot** . This slot is for a Secure Digital™/MultimediaCard storage card.
10. **W/R LED w/r.** This LED lights up when data is being read from or written to the card reader.
11. **Eject button** . Press this button to eject the optical drive.
12. **Microphone port** . This Mic (pink) port connects a microphone.
13. **Headphone port** . This port connects a headphone with a stereo mini-plug.
14. **4-pin IEEE 1394a port** . This port provides high-speed connectivity for IEEE 1394a-compliant audio/video devices, storage peripherals, and other PC devices.







---

The information provided is intended as a general guide for reference. Specifications are subject to the barebone system you purchased.

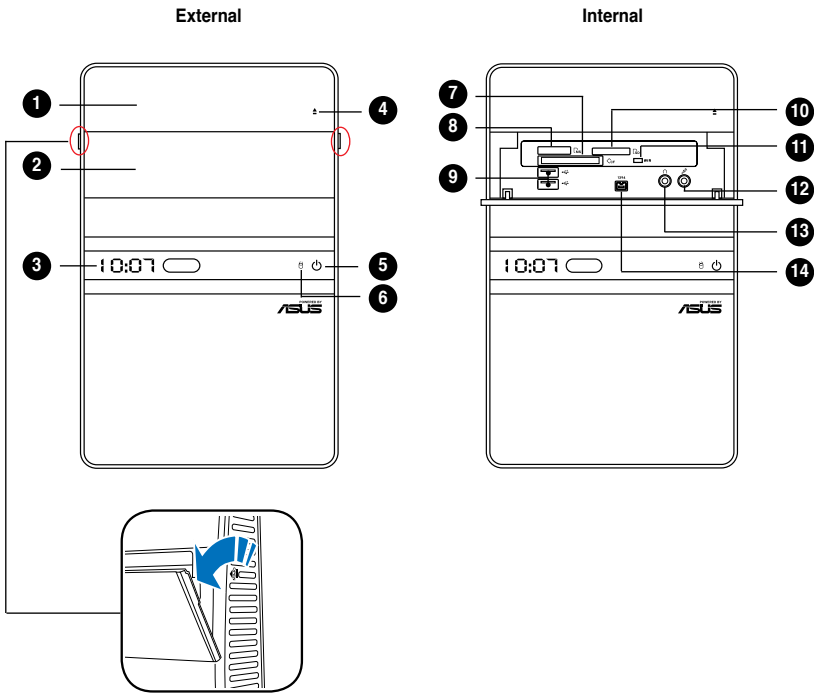



---

## 1.2.2 T4-P5G31 front panel



1. **Drive door.** Open this door to access the optical drive.
2. **Front panel I/O cover.** Open the front panel cover to show the input/output ports.
3. **Time and IR LED display** (optional)
4. **Eject button** . Press this button to eject the optical drive.
5. **Power button** . Press this button to turn the system on/off.
6. **HDD LED** . This LED lights up when data is being read from or written to the hard disk drive.

Open the front panel cover by pushing it.

7. **CompactFlash®/Microdrive™ card slot** . This slot is for a CompactFlash®/Microdrive™ storage card.
8. **Memory Stick®/Memory Stick Pro™ card slot**. This slot is for a Memory Stick®/Memory Stick Pro™ storage card.
9. **USB 2.0 ports**  **2.0**. These Universal Serial Bus 2.0 (USB 2.0) ports are available for connecting USB 2.0 devices such as a mouse, printer, scanner, camera, PDA, and others.
10. **Secure Digital™/MultimediaCard slot**  **SD**. This slot is for a Secure Digital™/MultimediaCard storage card.
11. **W/R LED w/R**. This LED lights up when data is being read from or written to the card reader.
12. **Microphone port** . This Mic (pink) port connects a microphone.
13. **Headphone port** . This port connects a headphone with a stereo mini-plug.
14. **4-pin IEEE 1394a port** **1394**. This port provides high-speed connectivity for IEEE 1394a-compliant audio/video devices, storage peripherals, and other PC devices.



---

The information provided is intended as a general guide for reference.  
Specifications are subject to the barebone system you purchased.





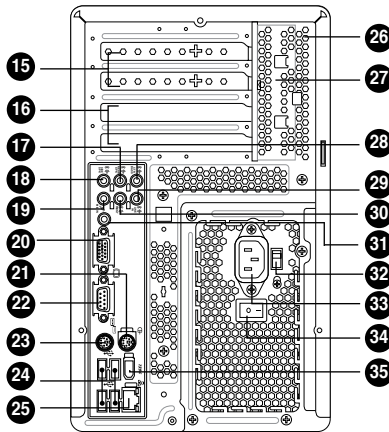

---

## 1.3 Rear panel



The system rear panel includes the power connector and several I/O ports that allow convenient connection of devices.



T3-P5G31 / T4-P5G31

15. **Expansion slot covers.** Remove these covers when installing expansion cards.
16. **Expansion slots.** Use this slot when installing expansion card.
17. **Rear surround speakers.** This port connects to a high-definition six-channel speaker.
18. **Side surround speakers.** This port connects to a high-definition six-channel speaker.
19. **Microphone port** . This Microphone (pink) port connects a microphone. In 4/6-channel mode, the function of this port becomes Low Frequency Enhanced Output/Center.
20. **VGA port** . This port connects a VGA monitor.
21. **PS/2 mouse port** . This green 6-pin connector is for a PS/2 mouse.
22. **COM port** . This port connects a mouse, modem, or other devices that conforms with serial specification.
23. **PS/2 keyboard port** . This purple 6-pin connector is for a PS/2 keyboard.
24. **USB 2.0 ports**  **2.0**. These Universal Serial Bus 2.0 (USB 2.0) ports are available for connecting USB 2.0 devices such as a mouse, printer, scanner, camera, PDA, and others.
25. **LAN port.** This port allows connection to a Local Area Network (LAN) through a network hub.



26. **Chassis vent.** This vent is for the fan that provides ventilation inside the system chassis.
27. **Expansion card lock.** This lock secures installed expansion cards. See page 2-13 for details.
28. **Center & woofer speakers.** This port connects the center/subwoofer speakers.
29. **Line In port** . This Line In (light blue) port connects a tape player or other audio sources. In 6-channel mode, the function of this port becomes Surround output.
30. **Line Out port** . This Line Out (lime) port connects a headphone or a speaker. In 4/6-channel mode, the function of this port becomes Front Speaker Out.
31. **Coaxial S/PDIF Out port.** This port connects an external audio output device via a coaxial S/PIF cable.
32. **Voltage selector.** This switch allows you to adjust the system input voltage according to the voltage supply in your area.
33. **Power connector.** This connector is for a power cable and plug.
34. **Power switch.** This switch allows you to turn your PC on/off.
35. **6-pin IEEE 1394a port** . This port provides high-speed connectivity for IEEE 1394a-compliant audio/video devices, storage peripherals, and other PC devices.

# 1.4 Internal components

The illustration below is the internal view of the system when you remove the top cover and the power supply unit. The installed components are labeled for your reference. Proceed to Chapter 2 for instructions on installing additional system components.



The illustration shows an open chassis lifted at a 90° angle.

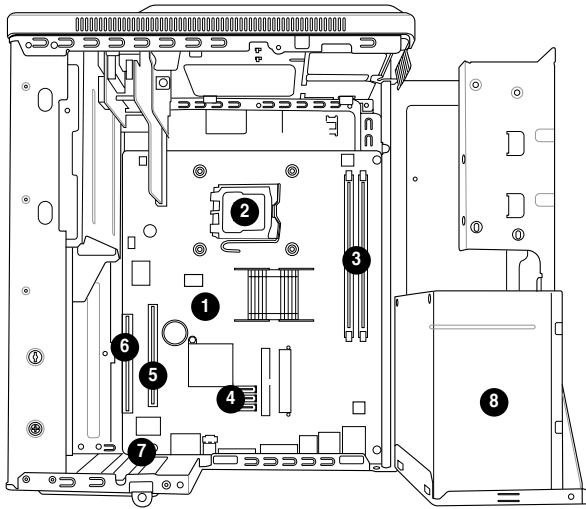

T3-P5G31

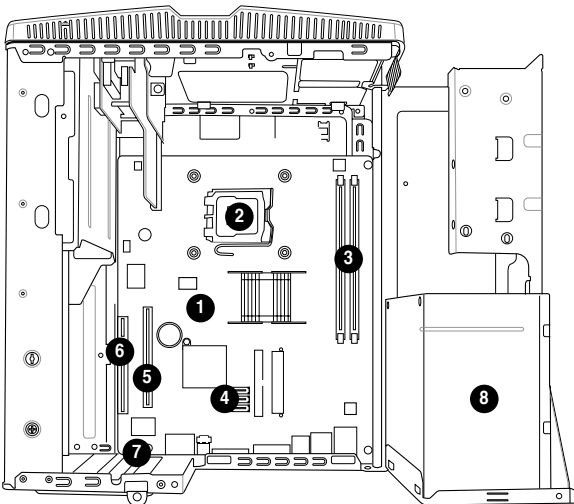

T4-P5G31

1. ASUS motherboard
2. LGA775 socket with PnP cap
3. DIMM sockets
4. Serial ATA connectors
5. PCI Express™ x16 slot for discrete graphics card
6. PCI slot
7. Expansion card slot
8. Power supply unit



# Chapter 2

This chapter provides step-by-step instructions on how to install components in the system.

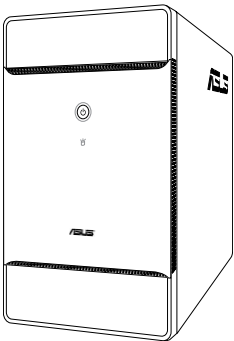

**T3-P5G31**

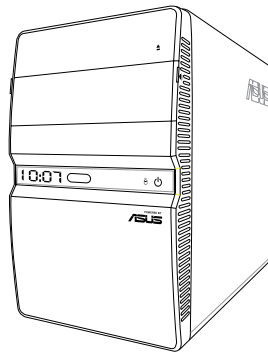

**T4-P5G31\***

\* Only some of the T4 models have the Time and IR LED display.

## 2.1 Preparation

Before you proceed, ensure that you have all the components you plan to install in the system.

### Basic components to install

1. Central Processing Unit (CPU)
2. DDR2 Dual Inline Memory Module (DIMM)
3. Expansion card(s)
4. Hard disk drive
5. Optical drive

### Tool

Philips (cross) screw driver

## 2.2 Before you proceed

Take note of the following precautions before you install components into the system.



- Use a grounded wrist strap or touch a safely grounded object or a metal object, such as the power supply case, before handling components to avoid damaging them due to static electricity.
- Hold components by the edges to avoid touching the ICs on them.
- Whenever you uninstall any component, place it on a grounded antistatic pad or in the bag that came with the component.

The motherboard comes with an onboard standby power LED. This LED lights up to indicate that the system is ON, in sleep mode or in soft-off mode, and not powered OFF. Unplug the power cable from the power outlet and ensure that the standby power LED is OFF before installing any system component.

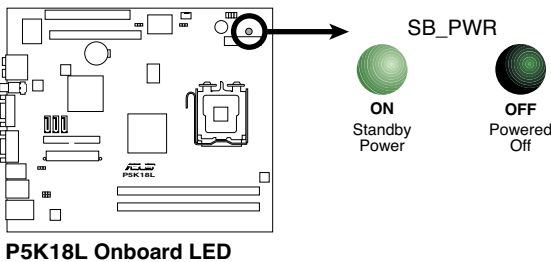

## 2.3 Removing the cover

To remove the cover:

1. On the rear panel, locate the three screws that secure the cover to the chassis.

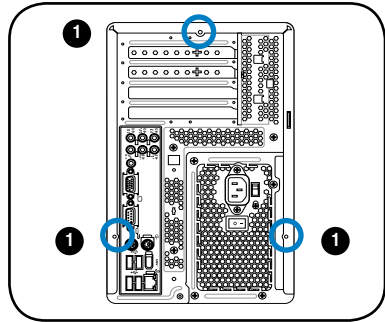

2. Use a Phillips screw driver to remove the cover screws. Keep the screws for later use.

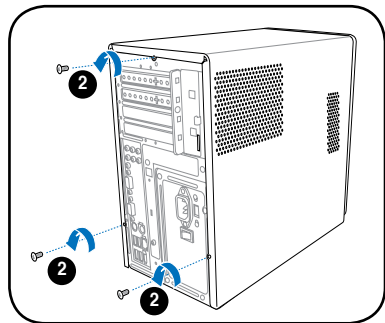

3. Slightly pull the cover toward the rear panel until the side tabs are disengaged from the chassis.
4. Lift the cover, then set aside.

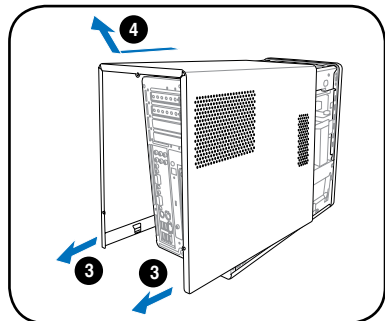

## 2.4 Power supply unit

You need to turn over the power supply unit (PSU) section on the side before you can install a central processing unit (CPU) and other system components.

To turn over the PSU:

1. Lay the system chassis on its side on a flat and stable surface.
2. Locate and remove the two screws that secures the PSU to the chassis.
3. Lift the PSU in the direction of the arrow to a 90° angle.

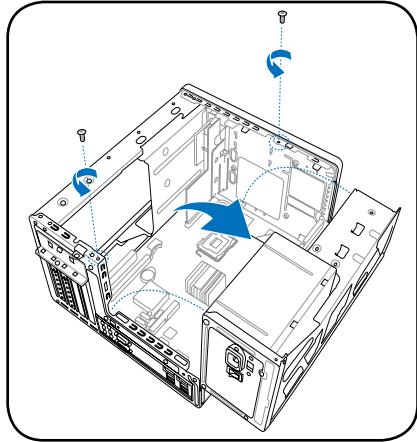

---

When removing the PSU, ensure to hold or support it firmly. The unit may accidentally drop and damage other system components.

---



## 2.5 CPU installation



- Your boxed Intel® Pentium® 4 LGA775 processor package should come with installation instructions for the CPU, heatsink, and the retention mechanism. If the instructions in this section do not match the CPU documentation, follow the latter.
- Check your motherboard to ensure that the PnP cap is on the CPU socket and the socket contacts are not bent. Contact your retailer immediately if the PnP cap is missing, or if you see any damage to the PnP cap/socket contacts/motherboard components. ASUS will shoulder the cost of repair only if the damage is shipment/transit-related.
- Keep the cap after installing the motherboard. ASUS will process Return Merchandise Authorization (RMA) requests only if the motherboard comes with the cap on the LGA775 socket.
- The product warranty does not cover damage to the socket contacts resulting from incorrect CPU installation/removal, or misplacement/loss/incorrect removal of the PnP cap.

### 2.5.1 Installing the CPU

To install a CPU:

1. Locate the CPU socket on the motherboard.

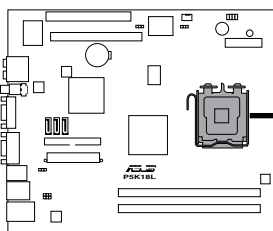

**P5K18L CPU Socket 775**



Before installing the CPU, ensure that the socket box is facing towards you and the load lever is on your left.

2. Press the load lever with your thumb (A), then move it to the left (B) until it is released from the retention tab.



To prevent damage to the socket pins, do not remove the PnP cap unless you are installing a CPU.

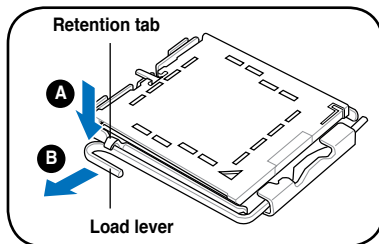

3. Lift the load lever in the direction of the arrow to a 135° angle.
4. Lift the load plate with your thumb and forefinger to a 100° angle (4A), then push the PnP cap from the load plate window to remove (4B).

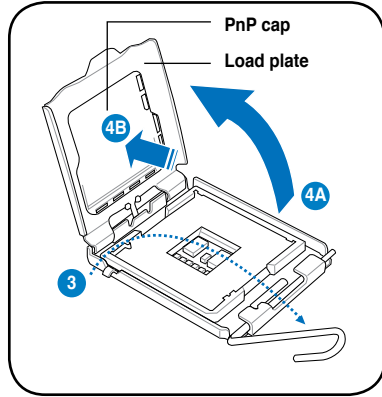

5. Position the CPU over the socket, ensuring that the gold triangle is on the bottom-left corner of the socket then fit the socket alignment key into the CPU notch.

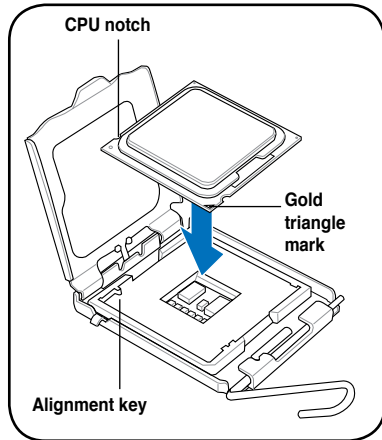

6. Close the load plate (A), then push the load lever (B) until it snaps into the retention tab.

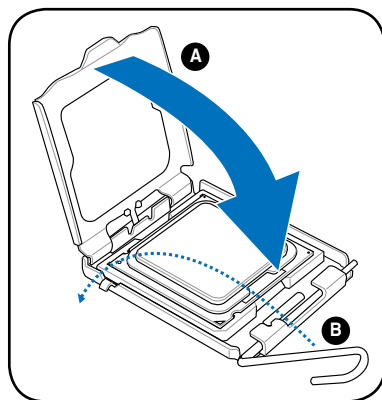

## 2.5.2 Installing CPU fan and heatsink assembly

The Intel® Pentium® 4 LGA775 processor requires a specially designed heatsink and fan assembly to ensure optimum thermal condition and performance.



- When you buy a boxed Intel® Pentium® 4 processor, the package includes the CPU fan and heatsink assembly. If you buy a CPU separately, ensure that you use only Intel®-certified multi-directional heatsink and fan.
- Your Intel® Pentium® 4 LGA775 heatsink and fan assembly comes in a push-pin design and requires no tool to install.



If you purchased a separate CPU heatsink and fan assembly, ensure that the Thermal Interface Material is properly applied to the CPU heatsink or CPU before you install the heatsink and fan assembly.

To install the CPU heatsink and fan:

1. Place the heatsink on top of the installed CPU, ensuring that the four fasteners match the holes on the motherboard.
2. Push down two fasteners at a time in a diagonal sequence to secure the heatsink and fan assembly in place.

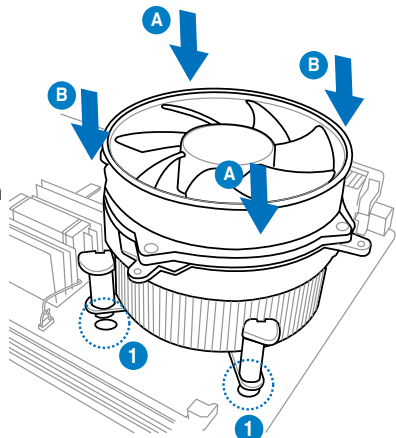
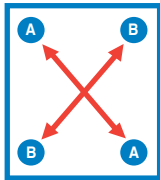

3. When the fan and heatsink assembly is in place, connect the CPU fan cable to the connector on the motherboard.

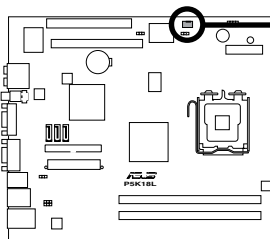

**P5K18L CPU Fan Connector**

CPU\_FAN



Do not forget to connect the CPU fan connector! Hardware monitoring errors can occur if you fail to plug this connector.

## 2.6 Installing a DIMM

The system motherboard comes with two Double Data Rate 2 (DDR2) Dual Inline Memory Module (DIMM) sockets.

The following figure illustrates the location of the sockets:

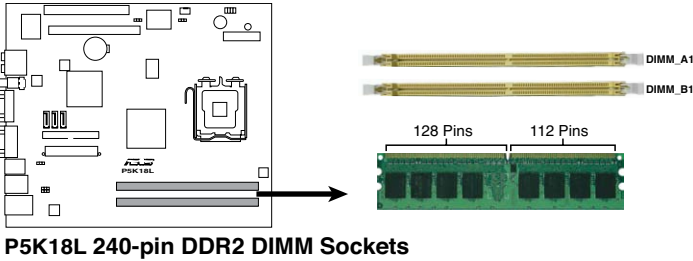

### 2.6.1 Memory configurations

You may install up to 4 GB system memory using 256 MB, 512 MB, 1 GB, and 2 GB DDR2 DIMMs.



- Installing DDR2 DIMMs other than the recommended configurations may cause memory sizing error or system boot failure. Use any of the recommended configurations in the table on the next page.
- Install only **identical** (the same type and size) DDR2 DIMMs in DIMM\_A1 and DIMM\_B1.
- Always install DIMMs with the same CAS latency. For optimum compatibility, we recommend that you obtain memory modules from the same vendor.
- Due to chipset resource allocation, the system may detect less than 4 GB system memory when you installed two 2 GB DDR2 memory.
- This motherboard does not support memory modules made up of 128 Mb chips or double-sided x16 memory modules.

### Recommended memory configurations

Mode	Sockets	
	DIMM_A1	DIMM_B1
Single-channel	Populated	
		Populated
Dual-channel	Populated	Populated

## DDR2 (800 MHz) Qualified Vendors List

Size	Vendor	Chip No.	CL	Chip Brand	SS/DS	Part No.	DIMM support	
							A*	B*
512MB	KINGSTON	K4T51083QC	5	SEC	SS	KVR800D2N5/512	•	•
1024MB	KINGSTON	Heat-Sink Package	4-4-4-12	N/A	DS	KHX6400D2LL/1G	•	
1024MB	KINGSTON	Heat-Sink Package	4-4-4-12	N/A	SS	KHX6400D2LLK2/1GN	•	•
1024MB	KINGSTON	V59C1512804QBF25	N/A	N/A	DS	KVR800D2N5/1G	•	•
1024MB	KINGSTON	Heat-Sink Package	N/A	N/A	SS	KHX6400D2ULK2/1G	•	•
2048MB	KINGSTON	Heat-Sink Package	N/A	N/A	DS	KHX6400D2ULK2/2G	•	•
512MB	Qimonda	HYB18T512800BF25F	5-5-5	N/A	SS	HYS64T64000HU-25F-B	•	•
1024MB	Qimonda	HYB18T512800BF25F	5-5-5	N/A	DS	HYS64T128020HU-25F-B	•	•
512MB	Hynix	HY5PS12821CFP-SS	5-5-5	Hynix	SS	HYMP564U64CP8-SS	•	•
1024MB	Hynix	HY5PS12821CFP-SS	5-5-5	Hynix	DS	HYMP512U64CP8-SS	•	
512MB	MICRON	D9GKX	N/A	N/A	SS	MT8HTF6464AY-80ED4	•	•
1024MB	MICRON	D9GKX	N/A	N/A	DS	MT16HTF12864AY-80ED4	•	
512MB	CORSAIR	Heat-Sink Package	5	N/A	SS	CM2X512A-6400	•	•
1024MB	CORSAIR	Heat-Sink Package	4	N/A	DS	CM2X1024-6400C4	•	
512MB	Crucial	Heat-Sink Package	4	N/A	SS	BL6464AA804.8FD	•	•
512MB	Crucial	Heat-Sink Package	4	N/A	SS	BL6464AA804.8FD3	•	•
1024MB	Crucial	Heat-Sink Package	4	N/A	DS	BL12864AA804.16FD	•	•
1024MB	Crucial	Heat-Sink Package	4	N/A	DS	BL12864AL804.16FD3	•	•
1024MB	Crucial	Heat-Sink Package	4	N/A	DS	BL12864AA804.16FD3	•	•
512MB	Apacer	Heat-Sink Package	5	N/A	DS	AHU512E800C5K1C	•	
1024MB	Apacer	Heat-Sink Package	5	N/A	DS	AHU01GE800C5K1C	•	•
512MB	A-DATA	AD29608A8A-25EG	N/A	N/A	SS	M2OAD6G3H3160G1E53	•	•
1024MB	A-DATA	AD28908A8A-25EG	N/A	N/A	DS	M2OAD6G3H4170H1E58	•	•
512MB	KINGMAX	KK48FEIBF-HJK-25A	N/A	KINGMAX	SS	KLDC28F-A8K15	•	
1024MB	KINGMAX	KK48FEIBF-HJK-25A	N/A	KINGMAX	DS	KLDD48F-ABK15	•	•
512MB	Super Talent	Heat-Sink Package	N/A	N/A	SS	T800UA12C4	•	•
1024MB	Super Talent	Heat-Sink Package	N/A	N/A	DS	T800UB1GC4	•	•
512MB	NANYA	NT5T64M8BE-25C	5	NANYA	SS	NT512T64U8H80BY-25C	•	•
1024MB	NANYA	NT5T64M8BE-25C	5	NANYA	DS	NT1GT64U8HB0BY-25C	•	•
1024MB	NANYA	NT5T64M8CE-25D	N/A	NANYA	DS	NT1GT64U8HCOBY-25D	•	•
512MB	PSC	A3R12E3HEF641B9A05	5	PSC	SS	AL6E8E63B8E1K	•	•
1024MB	PSC	A3R12E3HEF641B9A05	5	PSC	DS	AL7E8E63B-8E1K	•	
256MB	TwinMOS	E2508AB-GE-E	5	ELPIDA	SS	8G-24IK2-EBT	•	•
1024MB	Elixir	N2TU51280BE-25C	N/A	Elixir	DS	M2Y1G64TU8HB0B-25C	•	•

## DDR2 (667 MHz) Qualified Vendors List

Size	Vendor	Chip No.	CL	Chip Brand	SS/ DS	Part No.	DIMM support	
							A*	B*
512MB	KINGSTON	D6408TEBGGJ3U	5	KINGSTON	SS	KVR667D2N5/512	*	*
256MB	KINGSTON	HYB18T256800AF3S	5	N/A	SS	KVR667D2N5/256	*	*
256MB	KINGSTON	6SBI2D9DCG	5	MICRON	SS	KVR667D2N5/256	*	*
1024MB	KINGSTON	E5108AGBG-6E-E	N/A	KINGSTON	DS	KVR667D2N5/1G	*	
2048MB	KINGSTON	E1108AB-6E-E	N/A	ELPIDA	DS	KVR667D2N5/2G	*	*
512MB	Qimonda	HYB18T512800BF3S(ECC)	5-5-5	N/A	SS	HYS72T64000HU-3S-B	*	
1024MB	Qimonda	HYB18T512800BF3S(ECC)	5-5-5	N/A	DS	HYS72T128020HU-3S-B	*	
512MB	Qimonda	HYB18T512800BF3S	5	N/A	SS	HYS64T64000HU-3S-B	*	*
1024MB	Qimonda	HYB18T512800BF3S	5	N/A	DS	HYS64T128020HU-3S-B	*	*
512MB	SAMSUNG	K4T51163QE-ZCE6	5	SAMSUNG	DS	M378T3354EZ3-CE6	*	*
256MB	SAMSUNG	K4T51083QE	5	SAMSUNG	SS	M378T6553EZ3-CE6	*	*
1024MB	SAMSUNG	K4T51083QE	5	SAMSUNG	DS	M378T2953EZ3-CE6	*	*
256MB	Hynix	HY5PS121621CFP-Y5	5	Hynix	SS	HYMP532U64CP6-Y5	*	*
1024MB	Hynix	HY5PS12821CFP-Y5	5	Hynix	DS	HYMP512U64CP8-Y5	*	*
256MB	CORSAIR	MIII00605	N/A	N/A	SS	V5256MB667D2	*	*
512MB	CORSAIR	64M8CFEG	N/A	N/A	SS	V512MB667D2	*	*
1024MB	CORSAIR	64M8CFEG	N/A	N/A	DS	V51GB667D2	*	*
256MB	ELPIDA	E2508AB-6E-E	5	ELPIDA	SS	EBE25UC8ABFA-6E-E	*	*
512MB	ELPIDA	E5108AE-6E-E	5	ELPIDA	SS	EBE51UD8AEFA-6E-E	*	
512MB	A-DATA	AD29608A8A-3EG	5	A-DATA	SS	M2OAD5G3H3166H1C52	*	*
1024MB	A-DATA	AD29608A8A-3EG	5	A-DATA	DS	M2OAD5G3I4176H1C52	*	*
2048MB	A-DATA	NT5TU128M8BJ-3C	N/A	N/A	DS	M2ONY5H3J4170H1C5Z	*	*
512MB	crucial	Heat-Sink Package	3	N/A	SS	BL6464AA663.8FD	*	*
1024MB	crucial	Heat-Sink Package	3	N/A	DS	BL12864AA663.16FD	*	
1024MB	crucial	Heat-Sink Package	3	N/A	DS	BL12864AL664.16FD	*	*
1024MB	crucial	Heat-Sink Package	3	N/A	DS	BL12864AA663.16FD2	*	*
512MB	Apacer	AM4B5708GQJS7E0628F	5	APACER	SS	AU512E667C5KBGC	*	*
1024MB	Apacer	AM4B5708GQJS7E	5	APACER	DS	AU01GE667C5KBGC	*	*
256MB	Kingmax	N2TU51216AG-3C	5	NANYA	SS	KLCB8F-36KH5	*	*
512MB	Kingmax	KKEA88B4LAUG-29DX	5	KINGMAX	SS	KLCC28F-A8KB5	*	*
1024MB	Kingmax	KKEA88B4LAUG-29DX	5	KINGMAX	DS	KLCC48F-A8KB5	*	*
512MB	Super Talent	Heat-Sink Package	5	N/A	SS	T6UA512C5	*	*
1024MB	Super Talent	Heat-Sink Package	5	N/A	DS	T6UB1GC5	*	*
2048MB	NANYA	NT5TU128M8BJ-3C	5	NANYA	DS	NT2GT64U8HBOJY-3C	*	*
512MB	NANYA	NT5TU64M8BE-3C	5	NANYA	SS	NT512T64U88B0BY-3C	*	*
512MB	PSC	A3R12E3GEF637BLC5N	5	PSC	SS	AL6E8E63B-6E1K	*	*
1024MB	PSC	A3R12E3GEF637BLC5N	5	PSC	DS	AL7E8E63B-6E1K	*	*
512MB	TwinMOS	E5108AE-GE-E	5	ELPIDA	SS	8G-25JK5-EBT	*	
512MB	TwinMOS	TMM6208G8M30C	5	TwinMOS	SS	8D-23JK5M2ETP	*	*



---

**SS - Single-sided / DS - Double - sided****DIMM support:**

- **A\***: Supports one module inserted into any slot as Single-channel memory configuration.
  - **B\***: Supports one pair of modules inserted into either the yellow slots as one pair of Dual-channel memory configuration.
- 



Visit the ASUS website for the latest DDR2-800 / 667 MHz QVL.

---

## 2.6.2 DIMM installation

To install a DDR2 DIMM:

1. Locate the two DIMM sockets on the motherboard.
2. Unlock a socket by pressing the retaining clips outward.

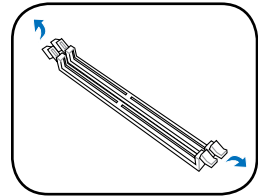

3. Align a DIMM on the socket such that the notch on the DIMM matches the break on the socket.

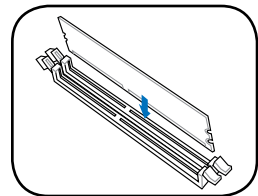

4. Firmly insert the DIMM into the socket until the retaining clips snap back in place and the DIMM is properly seated.

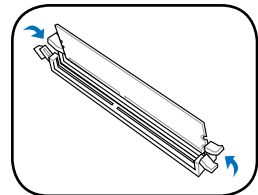

---

A DDR2 DIMM is keyed with a notch so that it fits in only one direction. **DO NOT** force a DIMM into a socket to avoid damaging the DIMM!

---

## 2.7 Installing an expansion card

In the future, you may need to install expansion cards. The motherboard has one PCI and one PCI Express™ x16 slot. The following sub-sections describe the slots and the expansion cards that they support.



Ensure to unplug the power cord before adding or removing expansion cards. Failure to do so may cause you physical injury and damage the motherboard.

### 2.7.1 Expansion slots

#### PCI slot

The PCI slots support PCI cards such as a LAN card, SCSI card, USB card, and other cards that comply with PCI specifications. The figure shows a LAN

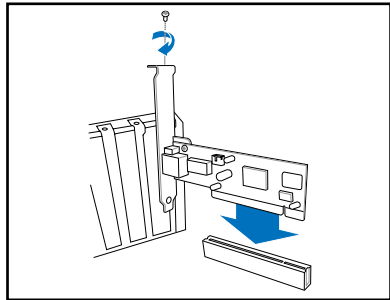

#### PCI Express™ x16 slot

This motherboard supports PCI Express™ x16 graphic cards that comply with PCI Express™ specifications. The figure shows a graphics card installed on the PCI Express™ x16 slot.

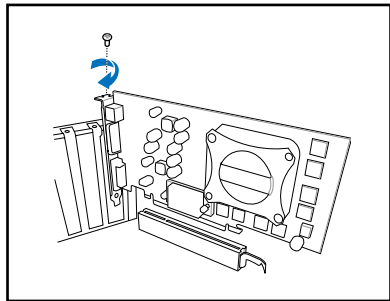

The chassis supports PCI Express x 16 cards with 192 mm x 19 mm or smaller dimensions only.



## 2.7.2 Expansion card installation

To install an expansion card:

1. Before installing the expansion card, read the documentation that came with it and make the necessary hardware settings for the card.
2. Locate and remove one metal bracket lock screw.
3. Remove the metal bracket lock.
4. Align the card connector with the slot, then press firmly.
5. Secure the card with one screw.
6. Replace the metal bracket lock, then secure it with one screw.

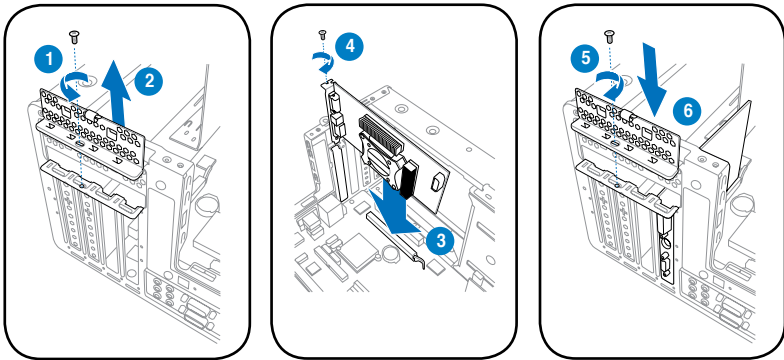

IRQ	Standard Function
0	System Timer
1	Keyboard Controller
2	Programmable Interrupt
4	Communications Port (COM1)
6	Floppy Disk Controller
7*	Printer Port (LPT1)
8	System CMOS/Real Time Clock
9*	ACPI Mode when used
10*	IRQ Holder for PCI Steering
11*	IRQ Holder for PCI Steering
12*	PS/2 Compatible Mouse Port
13	Numeric Data Processor
14*	Primary IDE Channel

\* These IRQs are usually available for ISA or PCI devices.

## IRQ assignments for this motherboard

	A	B	C	D	E	F	G	H
PCI slot	—	—	—	—	—	—	—	shared
PCI Express x16 slot	shared	—	—	—	—	—	—	—
Onboard USB controller 1	—	—	—	—	—	—	—	shared
Onboard USB controller 2	—	—	—	shared	—	—	—	—
Onboard USB controller 3	—	—	shared	—	—	—	—	—
Onboard USB controller 4	shared	—	—	—	—	—	—	—
Onboard USB 2.0 controller	—	—	—	—	—	—	—	shared
Onboard AC' 97 Audio	shared	—	—	—	—	—	—	—
Onboard LAN	—	shared	—	—	—	—	—	—
Onboard 1394	—	—	—	shared	—	—	—	—



When using a PCI card on shared slots, ensure that the drivers support “Share IRQ” or that the cards do not need IRQ assignments. Otherwise, conflicts will arise between the two PCI groups, making the system unstable and the card inoperable.

## 2.8 Installing an optical drive

The barebone system comes with a 5.25-inch drive bays for an optical drive.

To install an optical drive:

1. Place the chassis upright.
2. Insert the optical drive to the upper 5.25 in drive bay, then carefully push the drive until its screw holes align with the holes on the bay.
3. Secure the optical drive with four screws on both sides of the bay.
4. Connect the IDE and the power plugs to the connectors at the back of the drive.

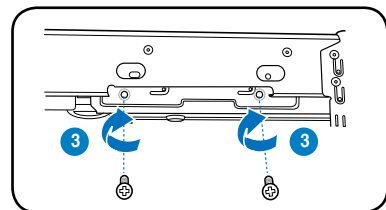
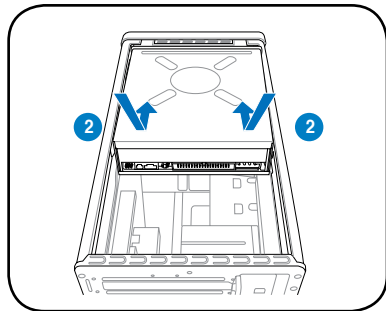

## 2.9 Installing a Serial ATA disk drive

The system supports one Serial ATA hard disk drive.

To install a Serial ATA hard disk drive:

1. Connect the SATA power cable to the plug of the power supply unit.

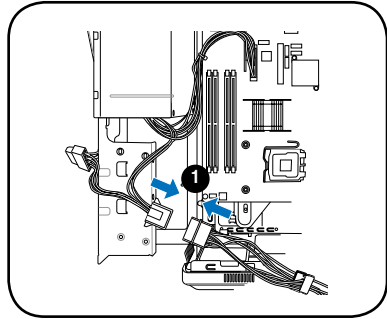

2. Connect the SATA signal cable and the power plugs to the connectors at the back of the drive.

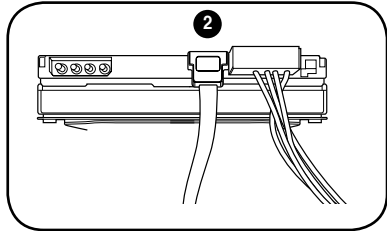

3. Locate the HDD tray.
4. Insert a hard disk drive (with the HDD PCB facing the top of the chassis) to the tray, then secure it with four screws.

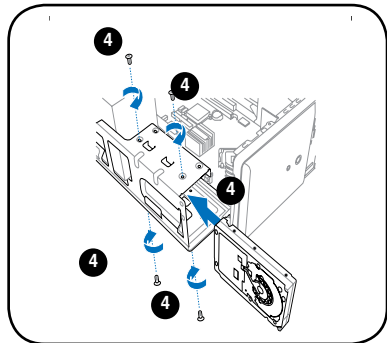

5. Connect the SATA signal cable to the SATA connector on the motherboard, and tighten all the cables with the plastic coils.

## 2.10 Replacing the power supply unit

Replace the power supply unit (PSU) after installing the system components and reconnecting the cables.

To replace the PSU:

1. If necessary, connect the 4-pin 12V power plug to the ATX12V connector on the motherboard.
2. If necessary, connect the 24-pin ATX power plug to the ATXPWR connector on the motherboard.
3. Connect the optical drive power connector.
4. Lift the PSU in the direction of the arrow until it properly fits in place.
5. Secure the PSU with the screws you removed earlier.

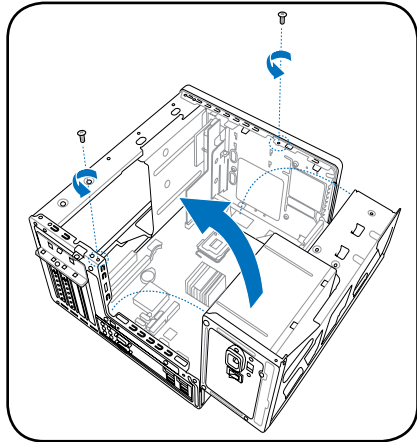

Make sure the PSU cables do not interfere with the CPU and/or chassis fans.

### Voltage selector

The PSU has a 115 V/230 V voltage selector switch located beside the power connector. Use this switch to select the appropriate system input voltage according to the voltage supply in your area.

If the voltage supply in your area is 100-127 V, set the switch to 115 V.

If the voltage supply in your area is 200-240 V, set the switch to 230 V.

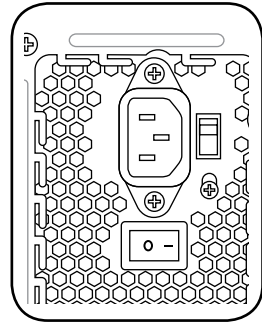

Setting the switch to 115 V in a 230 V environment will seriously damage the system!

## 2.11 Replacing the cover

To replace the cover:

1. Turn the chassis upright.
2. Position the front edge of the cover at least two inches from the front panel cover. Fit the cover tabs with the chassis rail and the front panel tabs.
3. Lower the rear edge of the cover as shown.
4. Push the cover slightly toward the front panel until it fits in place.
5. Secure the cover with the three screws you removed earlier.

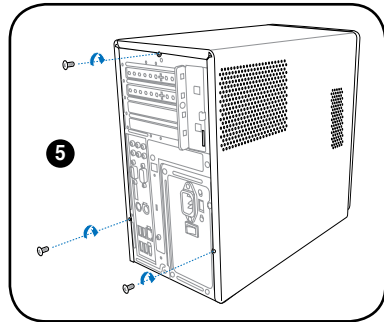
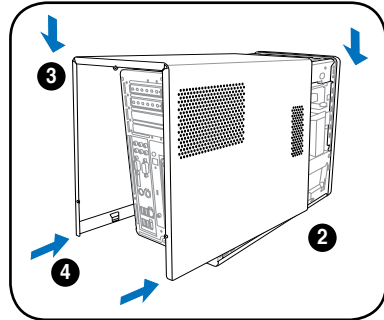



# Chapter 3

This chapter helps you power up the system and install drivers and utilities from the support CD.

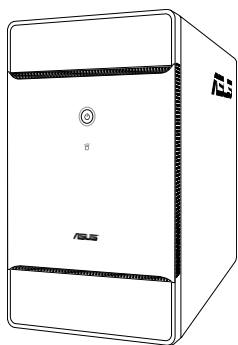

**T3-P5G31**

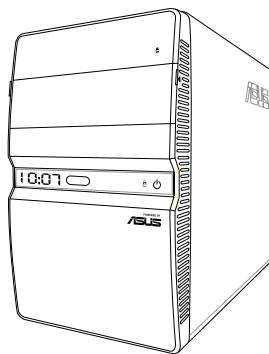

**T4-P5G31\***

\* Only some of the T4 models have the Time and IR LED display.

# Starting up

### 3.1 Installing an operating system

The barebone system supports Windows® 32-bit XP / 32-bit Vista / 64-bit XP / 64-bit Vista Operating Systems (OS). Always install the latest OS version and corresponding updates so you can maximize the features of your hardware.



Because motherboard settings and hardware options vary, use the setup procedures presented in this chapter for general reference only. Refer to your OS documentation for more information.

### 3.2 Powering up

The system power button is located on the front panel. Press the system power button (⏻) to enter the OS.

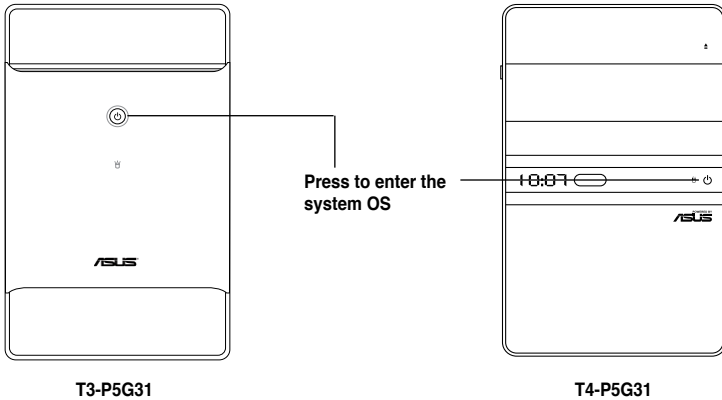

In Windows® OS, pressing the ⏻ button shuts down, restarts, or puts the system in sleep mode (S3) depending on the OS setting.



## 3.3 Support CD information

The support CD that came with the system contains useful software and several utility drivers that enhance the system features.



- Screen display and driver options may not be the same for other operating system versions.
- The contents of the support CD are subject to change at any time without notice. Visit the ASUS website for updates.

### 3.3.1 Running the support CD

To begin using the support CD, place the CD in your optical drive. The CD automatically displays the **Drivers** menu if Autorun is enabled in your computer.

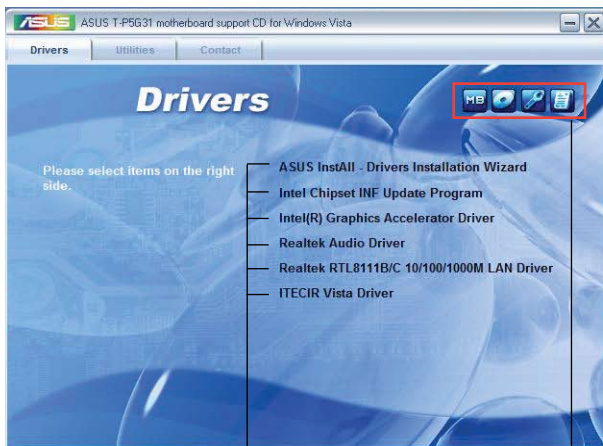

Click an item to install

Click an icon to display other information



If **Autorun** is NOT enabled in your computer, browse the contents of the support CD to locate the file **ASSETUP.EXE** from the **BIN** folder. Double-click the **ASSETUP.EXE** to run the CD.

### 3.3.2 Drivers menu

The drivers menu shows the available device drivers if the system detects installed devices. Install the necessary drivers to activate the devices.

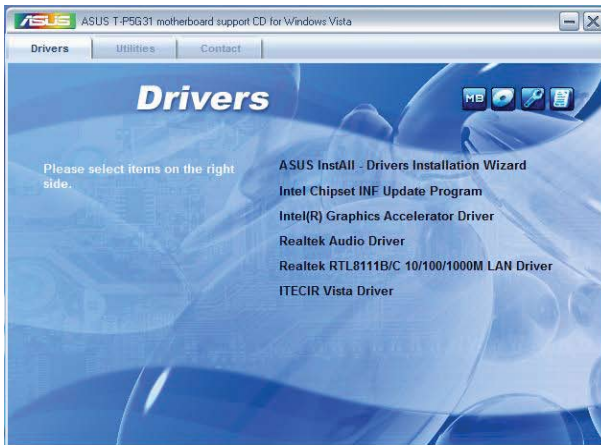

#### **ASUS InstAll - Drivers Installation Wizard**

Allows you to easily install all necessary drivers for your system.

#### **Intel(R) Chipset INF Update Program**

Installs the Intel® Chipset INF Update Program.

#### **Intel(R) Graphics Accelerator Driver**

Installs the Intel® graphics accelerator driver.

#### **Realtek Audio Driver**

Installs the Realtek audio driver.

#### **Realtek RTL8111B/C 10/100/1000M LAN Driver**

Installs the Realtek RTL8111B/C 10/100/1000M LAN driver.

#### **ITECIR Vista Driver**

Installs the ITECIR Vista driver.



---

The **ITECIR Vista Driver** item appears only in some models with **IR feature\***.  
(\*optional).

---

### 3.3.3 Utilities menu

The Utilities menu shows the applications and other software that the motherboard supports.

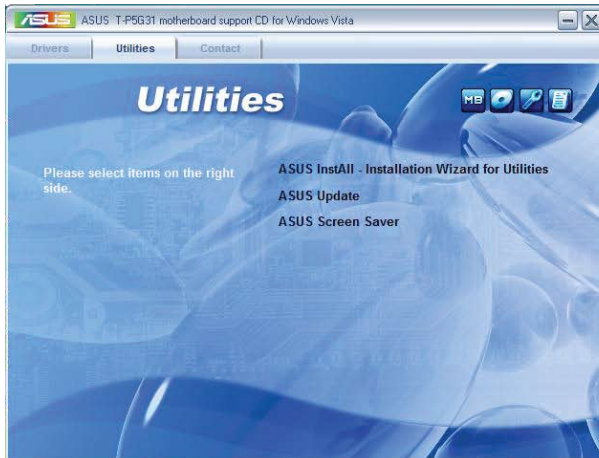

#### **ASUS InstAll - Installation Wizard for Utilities**

Allows you to easily install all bundled utilities for this motherboard.

#### **ASUS Update**

Installs the ASUS Update that allows you to update the motherboard BIOS and drivers. This utility requires an Internet connection either through a network or an Internet Service Provider (ISP). See page 5-8 for details.

#### **Adobe Screen Saver**

Bring life to your idle screen by installing the ASUS Screen Saver.

### 3.3.4 ASUS contact information

The Contact tab displays the ASUS contact information.



# Chapter 4

This chapter gives information about the motherboard that comes with the system. This chapter includes the motherboard layout, jumper settings, and connector locations.

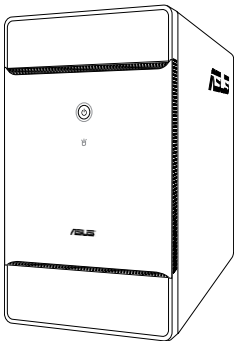

**T3-P5G31**

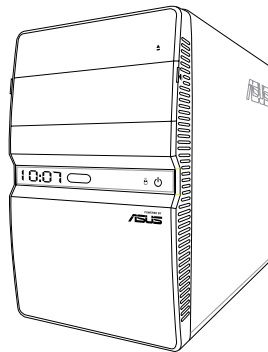

**T4-P5G31\***

\* Only some of the T4 models have the Time and IR LED display.

# 4.1 Introduction

The motherboard comes already installed in ASUS T-P5G31 system. This chapter provides technical information about the motherboard for future upgrades or system reconfiguration.

# 4.2 Motherboard layout

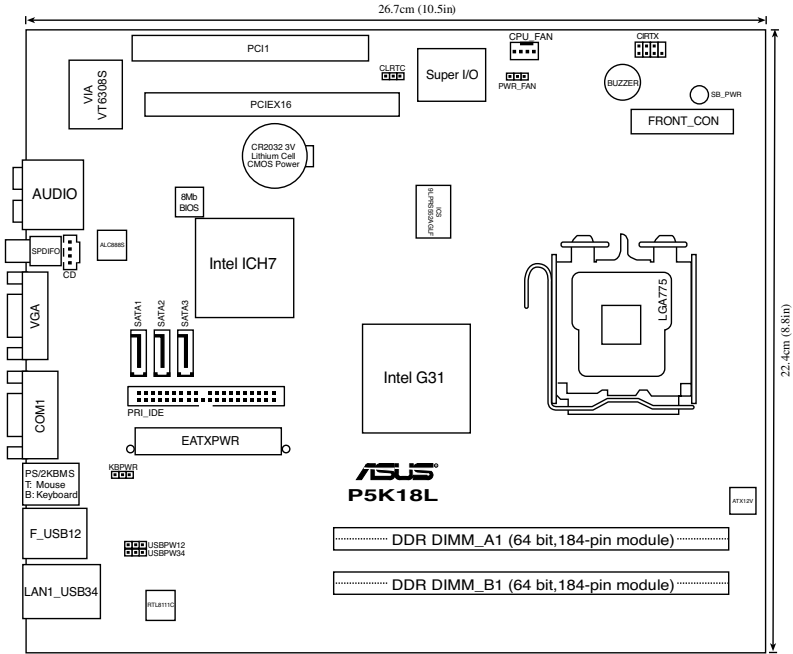

## 4.3 Jumpers

### 1. Clear RTC RAM (CLRRTC)

This jumper allows you to clear the Real Time Clock (RTC) RAM in CMOS. You can clear the CMOS memory of date, time, and system setup parameters by erasing the CMOS RTC RAM data. The onboard button cell battery powers the RAM data in CMOS, which include system setup information such as system passwords.

To erase the RTC RAM:

1. Turn OFF the computer and unplug the power cord.
2. Remove the onboard battery.
3. Move the jumper cap from pins 1-2 (default) to pins 2-3. Keep the cap on pins 2-3 for about 5~10 seconds, then move the cap back to pins 1-2.
4. Re-install the battery.
5. Plug the power cord and turn ON the computer.
6. Hold down the <Del> key during the boot process and enter BIOS setup to re-enter data.



Except when clearing the RTC RAM, never remove the cap on CLRRTC jumper default position. Removing the cap will cause system boot failure!

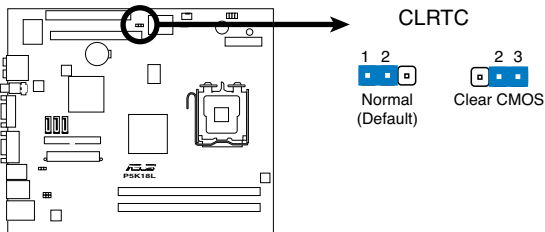

**P5K18L Clear RTC RAM**

**2. USB device wake-up (3-pin USBPW12, USBPW34)**

Set these jumpers to +5V to wake up the computer from S1 sleep mode (CPU stopped, DRAM refreshed, system running in low power mode) using the connected USB devices. Set to +5VSB to wake up from S3 and S4 sleep modes (no power to CPU, DRAM in slow refresh, power supply in reduced power mode).

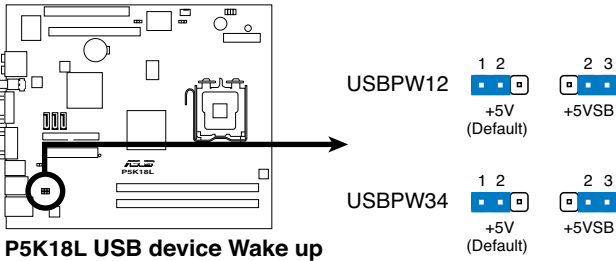

- The USB device wake-up feature requires a power supply that can provide 500mA on the +5VSB lead for each USB port. Otherwise, the system would not power up.
- The total current consumed must NOT exceed the power supply capability (+5VSB) whether under normal condition or in sleep mode.

**3. Keyboard power (3-pin KBPWR)**

This jumper allows you to enable or disable the keyboard wake-up feature. Set this jumper to pins 2-3 (+5VSB) to wake up the computer when you press a key on the keyboard (the default is the Space Bar). This feature requires an ATX power supply that can supply at least 1A on the +5VSB lead, and a corresponding setting in the BIOS.

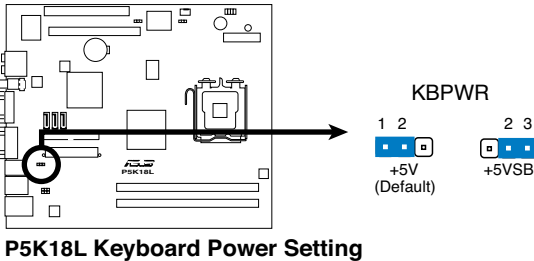



#### 4. Fan power (3-pin PWR\_FAN)

Set this jumper to 1-2 (Default) if you are using a 4-pin CPU fan. Set this jumper to 2-3 if you are using a 3-pin CPU fan.

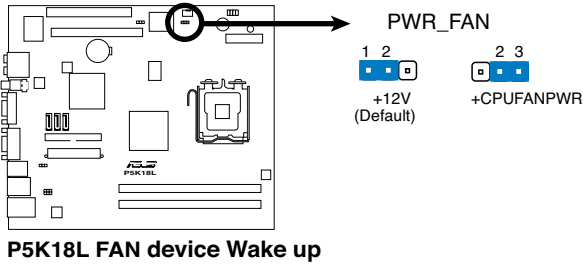

## 4.4 Connectors

This section describes and illustrates the connectors on the motherboard.

#### 1. CPU fan connector (4-pin CPU\_FAN)

The fan connector supports the proprietary CPU fan. Connect the fan cable to the fan connector on the motherboard, ensuring that the black wire of each cable matches the ground pin of the connector.

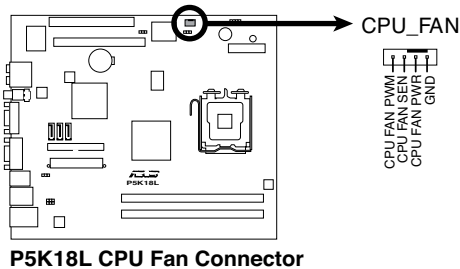

Do not forget to connect the fan cable to the fan connector. Insufficient air flow within the system may damage the motherboard components. These are not jumpers! DO NOT place jumper caps on the fan connectors!

**2. ATX power connectors (24-pin EATXPWR, 4-pin ATX12V)**

These connectors are for the 24-pin and 4-pin power plugs from the power supply unit. The plugs from the power supply unit are designed to fit these connectors in only one orientation. Find the proper orientation and push down firmly until the connectors completely fit.



Do not forget to connect the 4-pin ATX12V power plug to the ATX12V connector on the motherboard. Otherwise, the system will not boot up.

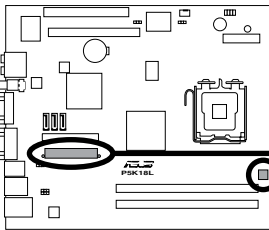

**P5K18L ATX Power Connector**

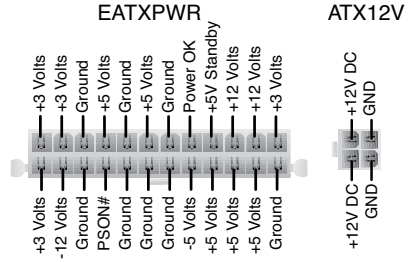

**3. IDE connector (40-1 pin PRI\_IDE)**

This connector is for an IDE 100/66 signal cable, a blue connector for the primary IDE connector on the motherboard

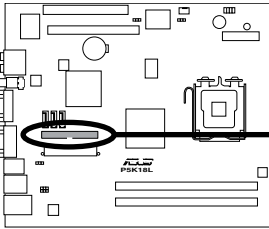

**P5K18L IDE Connector**

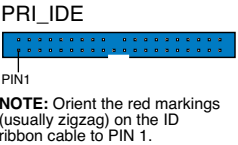

- Pin 20 on the IDE connector is removed to match the covered hole on the Ultra DMA cable connector. This prevents incorrect insertion when you connect the IDE cable.
- Use the 80-conductor IDE cable for Ultra DMA 100/66 IDE devices.

#### 4. Serial ATA connectors (7-pin SATA1, SATA2, SATA3)

These connectors are for the Serial ATA signal cables for Serial ATA hard disk drives.

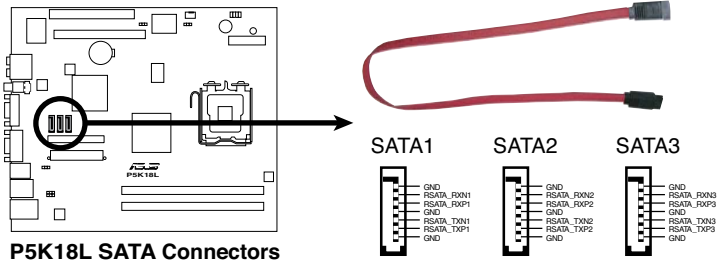

When using the connectors in Standard IDE mode, connect the primary (boot) hard disk drive to the SATA1/2 connector. Refer to the table below for the recommended SATA hard disk drive connections.

#### Serial ATA hard disk drive connection

Connector	Color	Setting	Use
SATA1/2	Red	Master	Boot disk
SATA3	Black	Slave	Data Disk



Connect the right-angle side of SATA signal cable to SATA device. Or you may connect the right-angle side of SATA cable to the onboard SATA port to avoid mechanical conflict with huge graphics cards.

right angle side

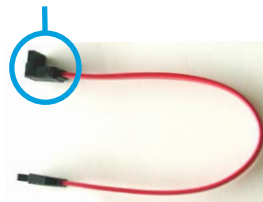

**5. Optical drive audio connector (4-pin CD)**

These connectors allow you to receive stereo audio input from sound sources such as a CD-ROM, TV tuner, or MPEG card.

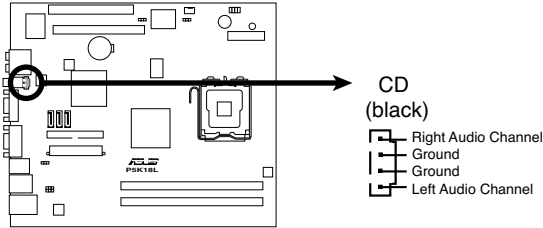

**P5K18L Internal Audio Connector**

# Chapter 5

This chapter tells how to change system settings through the BIOS Setup menus and describes the BIOS parameters.



**T3-P5G31**

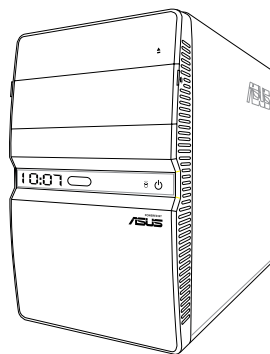

**T4-P5G31\***

\* Only some of the T4 models have the Time and IR LED display.

## 5.1 Managing and updating your BIOS

The following utilities allow you to manage and update the motherboard Basic Input/Output System (BIOS) setup.

1. **ASUS EZ Flash 2:** Updates the BIOS using a floppy disk, USB Flash, or the motherboard support CD during POST.
2. **ASUS AFUDOS:** Updates the BIOS in DOS mode using a bootable floppy disk.
3. **ASUS CrashFree BIOS 3:** Updates the BIOS using a bootable floppy disk, USB flash disk or the motherboard support CD when the BIOS file fails or gets corrupted.
4. **ASUS Update:** Updates the BIOS in Windows® environment.

Refer to the corresponding sections for details on these utilities.



- Save a copy of the original motherboard BIOS file to a bootable floppy disk in case you need to restore the BIOS in the future. Copy the original motherboard BIOS using the ASUS Update or AFUDOS utilities.
- All the floppy devices mentioned in this chapter are USB floppy devices.

### 5.1.1 Creating a bootable floppy disk

1. Do either one of the following to create a bootable floppy disk.

#### *DOS environment*

- a. Insert a 1.44MB floppy disk into the drive.
- b. At the DOS prompt, type **format A:/S** then press <Enter>.

#### *Windows® XP environment*

- a. Insert a 1.44 MB floppy disk to the floppy disk drive.
- b. Click **Start** from the Windows® desktop, then select **My Computer**.
- c. Select the 3 1/2 Floppy Drive icon.
- d. Click **File** from the menu, then select **Format**. A Format 3 1/2 Floppy Disk window appears.
- e. Windows® XP users: Select **Create an MS-DOS startup disk** from the format options field, then click **Start**.

#### *Windows® Vista environment*

- a. Insert a formatted, high density 1.44 MB floppy disk to the floppy disk drive.
  - b. Click  from the Windows® desktop, then select **Computer**.
  - c. Right-click **Floppy Disk Drive** then click **Format** to display the **Format 3 1/2 Floppy** dialog box .
  - d. Select the **Create an MS-DOS startup disk** check box.
  - e. Click **Start**.
2. Copy the original or the latest motherboard BIOS file to the bootable floppy disk.

## 5.1.2 ASUS EZ Flash 2 utility

The ASUS EZ Flash 2 feature allows you to update the BIOS without having to go through the long process of booting from a floppy disk and using a DOS-based utility. The EZ Flash 2 utility is built-in the BIOS chip so it is accessible by pressing <Alt> + <F2> during the Power-On Self-Test (POST).

To update the BIOS using EZ Flash 2:

1. Visit the ASUS website (www.asus.com) to download the latest BIOS file for the motherboard.
2. Save the BIOS file to a floppy disk or a USB flash disk, then restart the system.
3. You can launch the EZ Flash 2 by two methods.
  - (1) Insert the floppy disk / USB flash disk that contains the BIOS file to the floppy disk drive or the USB port.  
Press <Alt> + <F2> during POST to display the following.

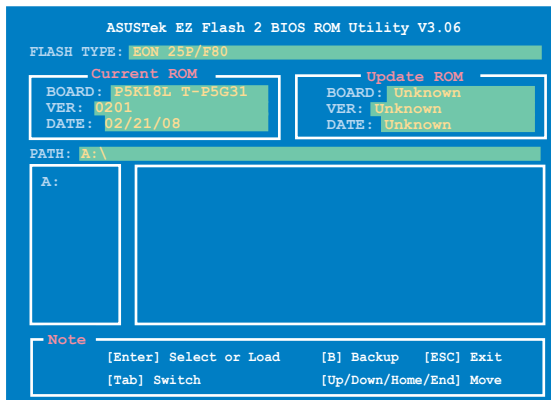

- (2) Enter BIOS setup program. Go to the **Tools** menu to select **EZ Flash2** and press <Enter> to enable it.  
You can switch between drives by pressing <Tab> before the correct file is found. Then press <Enter>.
4. When the correct BIOS file is found, EZ Flash 2 performs the BIOS update process and automatically reboots the system when done.



- This function can support devices such as USB flash disks, or floppy disks with **FAT 32/16** format only.
- Do not shut down or reset the system while updating the BIOS to prevent system boot failure!

### 5.1.3 AFUDOS utility

The AFUDOS utility allows you to update the BIOS file in DOS environment using a bootable floppy disk with the updated BIOS file. This utility also allows you to copy the current BIOS file that you can use as backup when the BIOS fails or gets corrupted during the updating process.

#### Copying the current BIOS

To copy the current BIOS file using the AFUDOS utility:



- Ensure that the floppy disk is not write-protected and has at least 1024KB free space to save the file.
- The succeeding BIOS screens are for reference only. The actual BIOS screen displays may not be same as shown.

1. Copy the AFUDOS utility (afudos.exe) from the motherboard support CD to the bootable floppy disk you created earlier.
2. Boot the system in DOS mode, then at the prompt type:

```
afudos /o[filename]
```

where the [filename] is any user-assigned filename not more than eight alphanumeric characters for the main filename and three alphanumeric characters for the extension name.

```
A:\>afudos /oOLDBIOS1.rom
```

Main filename                  Extension name

3. Press <Enter>. The utility copies the current BIOS file to the floppy disk.

```
A:\>afudos /oOLDBIOS1.rom
AMI Firmware Update Utility - Version 1.19(ASUS V2.29(03.11.24BB))
Copyright (C) 2002 American Megatrends, Inc. All rights reserved.
  Reading flash ..... done
  Write to file..... ok
A:\>
```

The utility returns to the DOS prompt after copying the current BIOS file.



## Updating the BIOS file

To update the BIOS file using the AFUDOS utility:

1. Visit the ASUS website ([www.asus.com](http://www.asus.com)) and download the latest BIOS file for the motherboard. Save the BIOS file to a bootable floppy disk.



Write the BIOS filename on a piece of paper. You need to type the exact BIOS filename at the DOS prompt.

2. Copy the AFUDOS utility (`afudos.exe`) from the motherboard support CD to the bootable floppy disk you created earlier.
3. Boot the system in DOS mode, then at the prompt type:  
**afudos /i[filename]**

where [filename] is the latest or the original BIOS file on the bootable floppy disk.

```
A:\>afudos /iT-P5G31.ROM
```

4. The utility verifies the file and starts updating the BIOS.

```
A:\>afudos /iT-P5G31.ROM
AMI Firmware Update Utility - Version 1.19(ASUS V2.07(03.11.24BB))
Copyright (C) 2002 American Megatrends, Inc. All rights reserved.

WARNING!! Do not turn off power during flash BIOS
Reading file ..... done
Reading flash ..... done

Advance Check .....
Erasing flash ..... done
Writing flash ..... 0x0008CC00 (9%)
```



Do not shut down or reset the system while updating the BIOS to prevent system boot failure!

5. The utility returns to the DOS prompt after the BIOS update process is completed. Reboot the system from the hard disk drive.

```
A:\>afudos /iT-P5G31.ROM
AMI Firmware Update Utility - Version 1.19(ASUS V2.07(03.11.24BB))
Copyright (C) 2002 American Megatrends, Inc. All rights reserved.

WARNING!! Do not turn off power during flash BIOS
Reading file ..... done
Reading flash ..... done

Advance Check .....
Erasing flash ..... done
Writing flash ..... done
Verifying flash .... done

Please restart your computer

A:\>
```

## 5.1.4 ASUS CrashFree BIOS 3 utility

The ASUS CrashFree BIOS 3 is an auto recovery tool that allows you to restore the BIOS file when it fails or gets corrupted during the updating process. You can update a corrupted BIOS file using the motherboard support CD , the floppy disk or the USB flash disk that contains the updated BIOS file.



- Prepare the motherboard support CD, the floppy disk or the USB flash disk containing the updated motherboard BIOS before using this utility.
- Ensure that you rename the original or updated BIOS file in the floppy disk or the USB flash disk to **T-P5G31.ROM**.

### Recovering the BIOS from a floppy disk

To recover the BIOS from a floppy disk:

1. Turn on the system.
2. Insert the floppy disk with the original or updated BIOS file to the floppy disk drive.
3. The utility displays the following message and automatically checks the floppy disk for the original or updated BIOS file.

```
Bad BIOS checksum. Starting BIOS recovery...
Checking for floppy...
```

When found, the utility reads the BIOS file and starts flashing the corrupted BIOS file.

```
Bad BIOS checksum. Starting BIOS recovery...
Checking for floppy...
Floppy found!
Reading file "T-P5G31.ROM". Completed.
Start flashing...
```



DO NOT shut down or reset the system while updating the BIOS! Doing so can cause system boot failure!

4. Restart the system after the utility completes the updating process.

## Recovering the BIOS from the support CD

To recover the BIOS from the support CD:

1. Remove any floppy disk from the floppy disk drive, then turn on the system.
2. Insert the support CD to the optical drive.
3. The utility displays the following message and automatically checks the floppy disk for the original or updated BIOS file.

```
Bad BIOS checksum. Starting BIOS recovery...
Checking for floppy...
```

When no floppy disk is found, the utility automatically checks the optical drive for the original or updated BIOS file. The utility then updates the corrupted BIOS file.

```
Bad BIOS checksum. Starting BIOS recovery...
Checking for floppy...
Floppy not found!
Checking for CD-ROM...
CD-ROM found!
Reading file "T-P5G31.ROM". Completed.
Start flashing...
```

4. Restart the system after the utility completes the updating process.



---

The recovered BIOS may not be the latest BIOS version for this motherboard. Visit the ASUS website ([www.asus.com](http://www.asus.com)) to download the latest BIOS file.

---

## Recovering the BIOS from the USB flash disk

To recover the BIOS from the USB flash disk:

1. Insert the USB flash disk that contains BIOS file to the USB port.
2. Turn on the system.
3. The utility will automatically checks the devices for the BIOS file. When found, the utility reads the BIOS file and starts flashing the corrupted BIOS file.
4. Restart the system after the utility completes the updating process.



- Only the USB flash disk with FAT 32/16 format and single partition can support ASUS CrashFree BIOS 3. The device size should be smaller than 8GB.
  - DO NOT shut down or reset the system while updating the BIOS! Doing so can cause system boot failure!
-

### 5.1.5 ASUS Update utility

The ASUS Update is a utility that allows you to manage, save, and update the motherboard BIOS in Windows® environment. The ASUS Update utility allows you to:

- Save the current BIOS file
- Download the latest BIOS file from the Internet
- Update the BIOS from an updated BIOS file
- Update the BIOS directly from the Internet, and
- View the BIOS version information.

This utility is available in the support CD that comes with the motherboard package.



---

ASUS Update requires an Internet connection either through a network or an Internet Service Provider (ISP).

---

### Installing ASUS Update

To install ASUS Update:

1. Place the support CD in the optical drive. The **Drivers** menu appears.
2. Click the Utilities tab, then click **Install ASUS Update**. See page 3-4 for the **Utilities** screen menu.
3. The ASUS Update utility is copied to your system.



---

Quit all Windows® applications before you update the BIOS using this utility.

---

## Updating the BIOS through the Internet

To update the BIOS through the Internet:

1. Launch the ASUS Update utility from the Windows® desktop by clicking **Start > Programs > ASUS > ASUSUpdate > ASUSUpdate**. The ASUS Update main window appears.

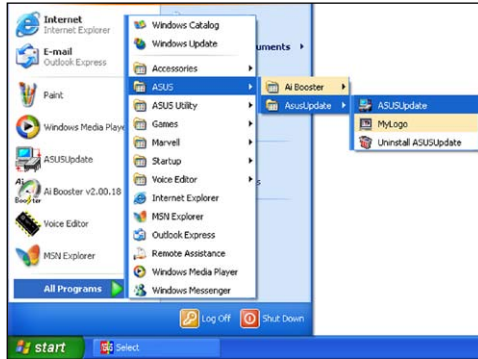

2. Select **Update BIOS from the Internet** option from the drop-down menu, then click **Next**.



3. Select the ASUS FTP site nearest you to avoid network traffic, or click **Auto Select**. Click **Next**.

- From the FTP site, select the BIOS version that you wish to download. Click **Next**.
- Follow the screen instructions to complete the update process.



The ASUS Update utility is capable of updating itself through the Internet. Always update the utility to avail all its features.

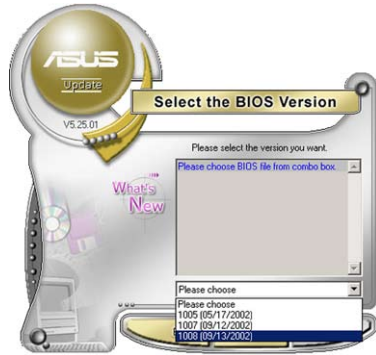

### Updating the BIOS through a BIOS file

To update the BIOS through a BIOS file:

- Launch the ASUS Update utility from the Windows® desktop by clicking **Start > Programs > ASUS > ASUSUpdate > ASUSUpdate**. The ASUS Update main window appears.
- Select **Update BIOS from a file** option from the drop-down menu, then click Next.

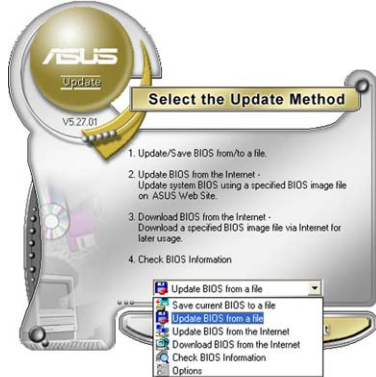

- Locate the BIOS file from the **Open** window, then click **Open**.
- Follow the screen instructions to complete the update process.

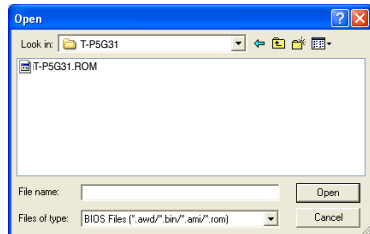

## 5.2 BIOS setup program

This motherboard supports a programmable firmware chip that you can update using the provided utility described in section “5.1 Managing and updating your BIOS.”

Use the BIOS Setup program when you are installing a motherboard, reconfiguring your system, or prompted to “Run Setup.” This section explains how to configure your system using this utility.

Even if you are not prompted to use the Setup program, you can change the configuration of your computer in the future. For example, you can enable the security password feature or change the power management settings. This requires you to reconfigure your system using the BIOS Setup program so that the computer can recognize these changes and record them in the CMOS RAM of the firmware chip.

The firmware chip on the motherboard stores the Setup utility. When you start up the computer, the system provides you with the opportunity to run this program. Press <Del> during the Power-On Self-Test (POST) to enter the Setup utility. Otherwise, POST continues with its test routines.

If you wish to enter Setup after POST, reboot the system by doing any of the following procedures:

- Restart using the OS standard shut-down procedure.
- Press <Ctrl>+<Alt>+<Del> simultaneously.
- Press the reset button on the system chassis.
- Press the power button to turn the system off then back on.



---

Using the **power button**, **reset button**, or the <Ctrl>+<Alt>+<Del> keys to force reset from a running operating system can cause damage to your data or system. We recommend to always shut-down the system properly from the operating system.

---

The Setup program is designed to make it as easy to use as possible. Being a menu-driven program, it lets you scroll through the various sub-menus and make your selections from the available options using the navigation keys.



- 
- The default BIOS settings for this motherboard apply for most conditions to ensure optimum performance. If the system becomes unstable after changing any BIOS settings, load the default settings to ensure system compatibility and stability. Select the **Load Default Settings** item under the Exit Menu. See section “5.8 Exit Menu.”
  - The BIOS setup screens shown in this section are for reference purposes only, and may not exactly match what you see on your screen.
  - Visit the ASUS website ([www.asus.com](http://www.asus.com)) to download the latest BIOS file for this motherboard.
-

## 5.2.1 BIOS menu screen

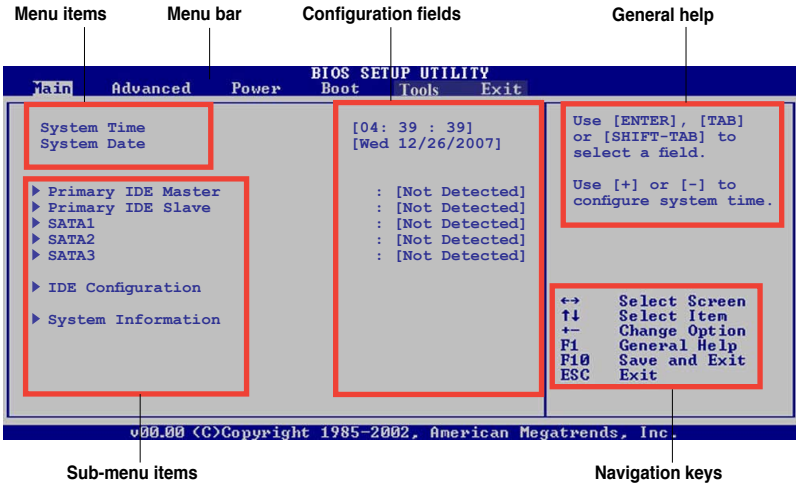

## 5.2.2 Menu bar

The menu bar on top of the screen has the following main items:

- Main** For changing the basic system configuration
- Advanced** For changing the advanced system settings
- Power** For changing the advanced power management (APM) configuration
- Boot** For changing the system boot configuration
- Tools** For setting EZ Flash 2 and AI NET 2
- Exit** For selecting the exit options and loading default settings

To select an item on the menu bar, press the right or left arrow key on the keyboard until the desired item is highlighted.



- The BIOS setup screens shown in this chapter are for reference purposes only, and may not exactly match what you see on your screen.
- Visit the ASUS website ([www.asus.com](http://www.asus.com)) to download the latest BIOS information.

## 5.2.3 Navigation keys

At the bottom right corner of a menu screen are the navigation keys for that particular menu. Use the navigation keys to select items in the menu and change the settings.





Some of the navigation keys differ from one screen to another.

## 5.2.4 Menu items

The highlighted item on the menu bar displays the specific items for that menu. For example, selecting Main shows the Main menu items.

The other items (Advanced, Power, Boot, and Exit) on the menu bar have their respective menu items.

## 5.2.5 Sub-menu items

A solid triangle before each item on any menu screen means that the item has a sub-menu. To display the sub-menu, select the item and press <Enter>.

## 5.2.6 Configuration fields

These fields show the values for the menu items. If an item is user-configurable, you can change the value of the field opposite the item. You cannot select an item that is not user-configurable.

A configurable field is enclosed in brackets, and is highlighted when selected. To change the value of a field, select it then press <Enter> to display a list of options. Refer to “2.2.7 Pop-up window.”

## 5.2.7 Pop-up window

Select a menu item then press <Enter> to display a pop-up window with the configuration options for that item.

## 5.2.8 Scroll bar

A scroll bar appears on the right side of a menu screen when there are items that do not fit on the screen. Press the Up/Down arrow keys or <Page Up> /<Page Down> keys to display the other items on the screen.

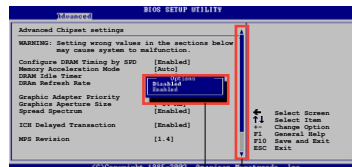

Pop-up window

Scroll bar

## 5.2.9 General help

At the top right corner of the menu screen is a brief description of the selected item.

## 5.3 Main menu

When you enter the BIOS Setup program, the Main menu screen appears, giving you an overview of the basic system information.



Refer to section “5.2.1 BIOS menu screen” for information on the menu screen items and how to navigate through them.

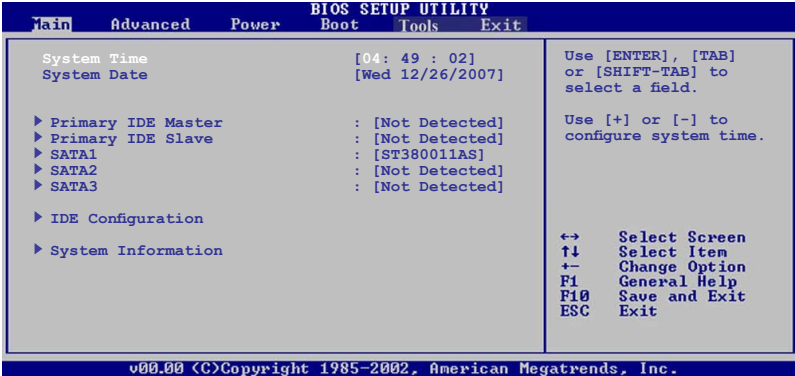

### 5.3.1 System Time [xx:xx:xx]

Allows you to set the system time.

### 5.3.2 System Date [Day xx/xx/xxxx]

Allows you to set the system date.

### 5.3.3 Primary IDE Master/Slave, SATA1~3

While entering Setup, the BIOS automatically detects the presence of IDE devices. There is a separate sub-menu for each IDE device. Select a device item then press <Enter> to display the IDE device information.

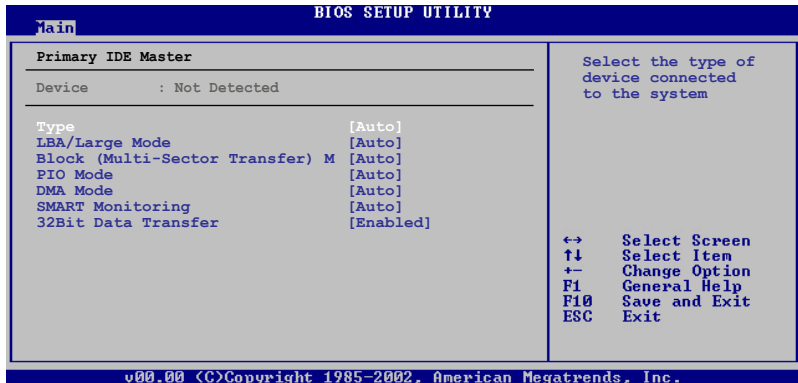

The BIOS automatically detects the values opposite the dimmed items (Device, Vendor, Size, LBA Mode, Block Mode, PIO Mode, Async DMA, Ultra DMA, and SMART monitoring). These values are not user-configurable. These items show N/A if no IDE device is installed in the system.

#### Type [Auto]

Selects the type of IDE drive. Setting to Auto allows automatic selection of the appropriate IDE device type. Select CDROM if you are specifically configuring a CD-ROM drive. Select ARMD (ATAPI Removable Media Device) if your device is either a ZIP, LS-120, or MO drive. Configuration options: [Not Installed] [Auto] [CDROM] [ARMD]



This item does not appear when you select **SATA1 / SATA2 / SATA3** devices.

#### LBA/Large Mode [Auto]

Enables or disables the LBA mode. Setting to Auto enables the LBA mode if the device supports this mode, and if the device was not previously formatted with LBA mode disabled. Configuration options: [Disabled] [Auto]

### Block (Multi-Sector Transfer) M [Auto]

Enables or disables data multi-sectors transfers. When set to Auto, the data transfer from and to the device occurs multiple sectors at a time if the device supports multi-sector transfer feature. When set to [Disabled], the data transfer from and to the device occurs one sector at a time.  
Configuration options: [Disabled] [Auto]

### PIO Mode [Auto]

Selects the PIO mode. Configuration options: [Auto] [0] [1] [2] [3] [4]

### DMA Mode [Auto]

Selects the DMA mode. Configuration options: [Auto]

### SMART Monitoring [Auto]

Enables or disables the S.M.A.R.T. (Self Monitoring and Reporting Technology) capability of your hard drive. This features allows your system to report read/write errors of the hard drive and to issue warnings when a third party hardware monitor utility is installed. Configuration options: [Auto] [Disabled] [Enabled]

### 32Bit Data Transfer [Enabled]

Enables or disables 32-bit data transfer. Configuration options: [Disabled] [Enabled]

## 5.3.4 IDE Configuration

The items in this menu allow you to set or change the configurations for the IDE devices installed in the system. Select an item then press <Enter> if you wish to configure the item.

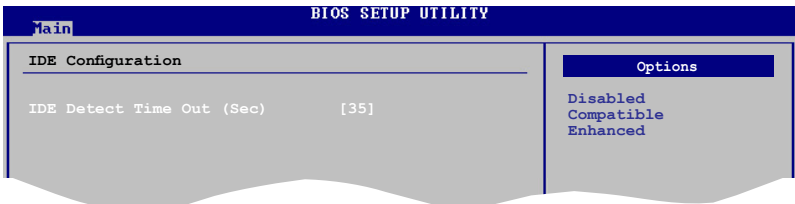

### IDE Detect Time Out (Sec) [35]

Allows you to select the time out value for detecting ATA/ATAPI device(s).  
Configuration options: [0] [5] [10] [15] [20] [25] [30] [35]

## 5.3.5 System Information

This menu gives you an overview of the general system specifications. The BIOS automatically detects the items in this menu.

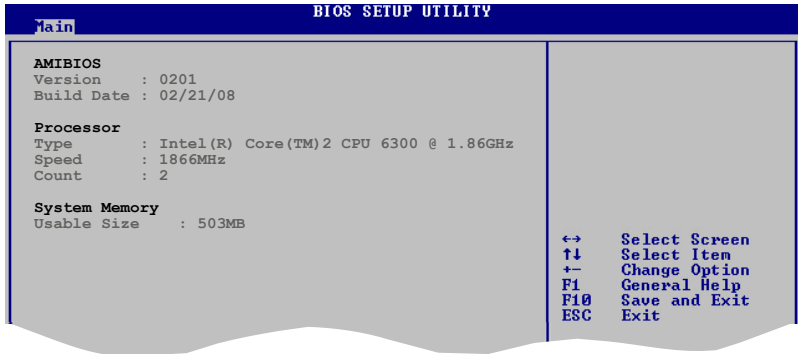

### AMI BIOS

Displays the auto-detected BIOS information

### Processor

Displays the auto-detected CPU specification

### System Memory

Displays the auto-detected system memory

## 5.4 Advanced menu

The Advanced menu items allow you to change the settings for the CPU and other system devices.



Take caution when changing the settings of the Advanced menu items. Incorrect field values can cause the system to malfunction.

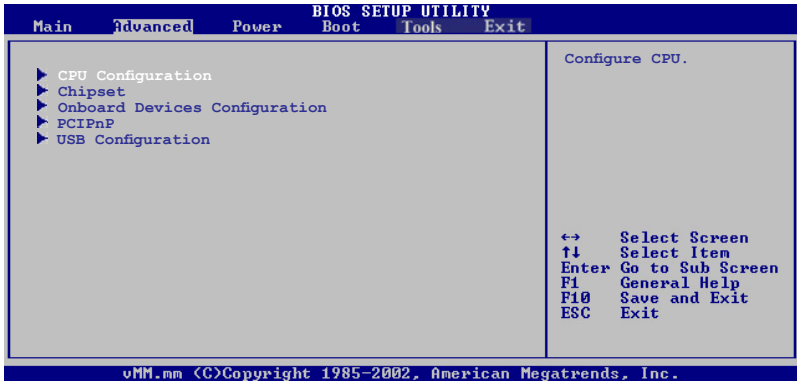

## 5.4.1 CPU Configuration

The items in this menu show the CPU-related information that the BIOS automatically detects.

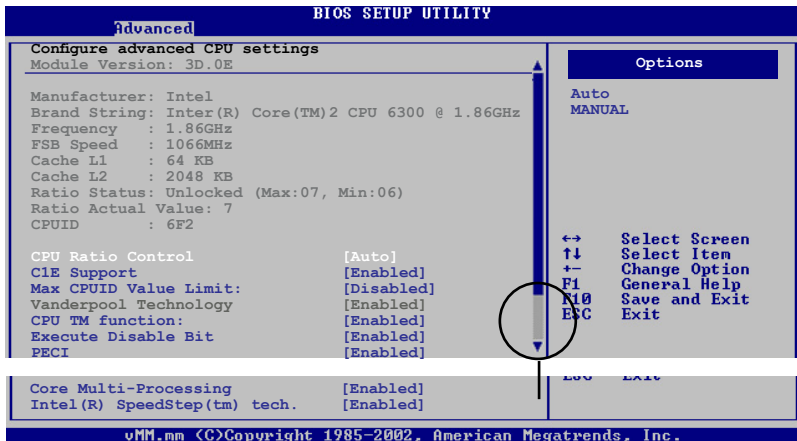

### CPU ratio adjustment [Auto]

Allows you to select the CPU ratio adjustment mode. Select [Manual] to set Ratio CMOS Setting. Configuration options: [Auto] [Manual]



The following item appears only when you set the CPU ratio adjustment item to [Manual].

#### Ratio CMOS Setting [7]

Sets the ratio between the CPU Core Clock and the Front Side Bus frequency. The default value of this item is auto-detected by BIOS. Use the <+> - <-> keys to adjust the BIOS.

### C1E Support [Enabled]

Allows you to enable or disable Inter CPU Enhanced Halt (C1E) function, a CPU power-saving function in system halt state. When enable, the CPU core frequency and voltage will be reduced during the system halt state to decrease power consumption. Configuration options: [Disabled] [Enabled]

### Max CPUID Value Limit [Disabled]

Allows you to determine whether to limit CPUID maximum value. Set this item to [Disabled] for Windows XP operating system; set this item to [Enabled] for legacy operating system such as Windows NT4.0. (Default: Disabled) Configuration options: [Disabled] [Enabled]

### **Vanderpool Technology [Enabled]**

Enables or disables Intel® Virtualization Technology. Virtualization enhanced by Intel® Virtualization Technology allows a platform to run multiple operating systems and applications in independent partitions. With virtualization, one computer system can function as multiple virtual systems. Configuration options: [Enabled] [Disabled]

### **CPU TM Function [Enabled]**

Enables or disables Intel® CPU Thermal Monitor (TM) function, a CPU overheating protection function. When enabled, the CPU core frequency and voltage are reduced when the CPU overheats. Configuration options: [Disabled] [Enabled]

### **Execute Disable Bit [Enabled]**

Enables or disables Intel® Execute Disable Bit function. This function enhances protection of your computer, reducing exposure to viruses and malicious buffer overflow attacks when working with its supporting software and system. Configuration options: [Disabled] [Enabled]

### **PECI [Disabled]**

Allows you to enable or disable PECI interface. Configuration options: [Disabled] [Enabled]



---

The following item appears only when you install an Intel® Core 2 Duo (E6000, E4000) series processor.

---

### **Core Multi-Processing [Enabled]**

Allows you to enable or disable one execution core. Configuration options: [Disabled] [Enabled]



---

The following item appears only when you installed an Intel® Pentium® 4 or later CPU that supports the Enhanced Intel SpeedStep® Technology (EIST).

---

### **Intel (R) SpeedStep (tm) tech. [Enabled]**

Allows you to use the Enhanced Intel® SpeedStep® Technology. When set to [Enabled], you can adjust the system power settings in the operating system to use the EIST feature. Set this item to [Disabled] if you do not want to use the EIST. Configuration options: [Enabled] [Disabled]



## 5.4.2 Chipset

The Chipset menu allows you to change the advanced chipset settings. Select an item then press <Enter> to display the sub-menu.

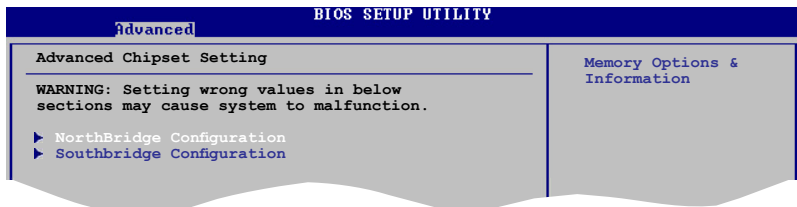

### North Bridge Configuration

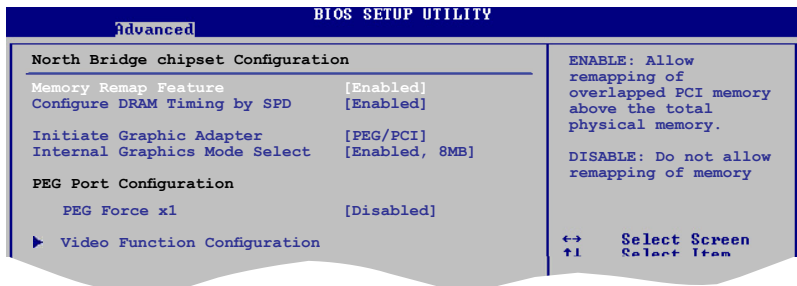

#### Memory Remap Feature [Enabled]

Allows you to enable or disable the remapping of overlapped PCI memory above the total physical memory. Configuration options: [Enabled] [Disabled]

#### Configure DRAM Timing by SPD [Enabled]

Allows you to enable or disable configuring DRAM Timing by SPD. Configuration options: [Enabled] [Disabled]

#### Initiate Graphic Adapter [PEG/PCI]

Allows you to select the graphics controller as the primary boot device. Configuration options: [IGD] [PCI/IGD] [PCI/PEG] [PEG/IGD] [PEG/PCI]

#### Internal Graphics Mode Select [Enabled, 8MB]

Allows you to select the amount of system memory used by the Internal graphics device. Configuration options: [Disabled] [Enabled, 1MB] [Enabled, 8MB]

#### PEG Port Configuration

##### *PEG Force x1 [Disabled]*

Allows you to enable or disable the PEG Force x 1.  
Configuration options: [Enabled] [Disabled]

## Video Function Configuration

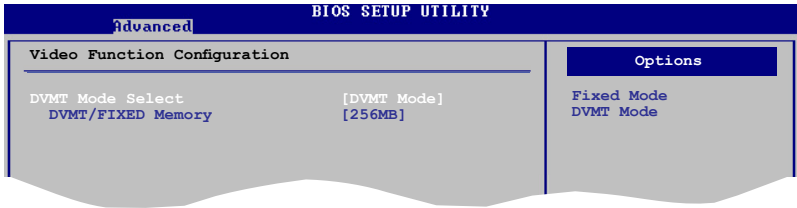

### *DVMT Mode Select [DVMT Mode]*

Allows you to select the DVMT Mode. Configuration options: [Fixed Mode] [DVMT Mode]

### **DVMT/FIXED Memory [256MB]**

Allows you to select the amount of the DVMT/FIXED Memory. Configuration options: [128MB] [256MB]

## South Bridge Configuration

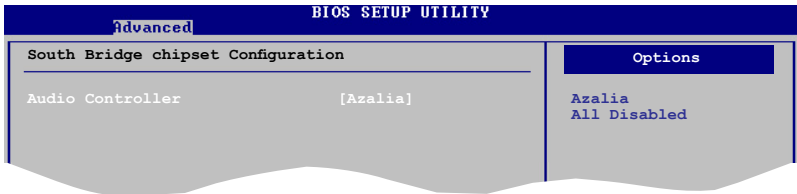

### **Audio Controller [Azalia]**

Allows you to set the audio controller. Configuration options: [Azalia] [All Disabled]

## 5.4.3 Onboard Devices Configuration

Advanced		BIOS SETUP UTILITY	
<b>Onboard Devices Configuration</b>		<b>Onboard PCIEX GbE LAN</b> Enabled/Disable.	
Onboard PCIE GbE LAN	[Enabled]		
LAN Option ROM	[Disabled]		
Serial Port1 Address	[2F8/IRQ3]		

### **Onboard PCIE GbE LAN [Enabled]**

Allows you to enable or disable the onboard PCIE GbE LAN.

Configuration options: [Enabled] [Disabled]

LAN Option ROM [Disabled]

Configuration options: [Disabled] [Enabled]

### **Serial Port1 Address [2F8/IRQ3]**

Allows you to select the Serial Port1 base address.

Configuration options: [Disabled] [3F8/IRQ4][2F8/IRQ3] [3E8/IRQ4] [2E8/IRQ3]

## 5.4.4 PCI PnP

The PCI PnP menu items allow you to change the advanced settings for PCI/PnP devices. The menu includes setting IRQ and DMA channel resources for either PCI/PnP or legacy ISA devices, and setting the memory size block for legacy ISA devices.



Take caution when changing the settings of the PCI PnP menu items. Incorrect field values can cause the system to malfunction.



### Plug and Play O/S [No]

When set to [No], BIOS configures all the devices in the system. When set to [Yes] and if you install a Plug and Play operating system, the operating system configures the Plug and Play devices not required for boot.

Configuration options: [No] [Yes]

### PCI Latency Timer [64]

Allows you to select the value in units of PCI clocks for the PCI device latency timer register. Configuration options: [32] [64] [96] [128] [160] [192] [224] [248]

### Allocate IRQ to PCI VGA [Yes]

When set to [Yes], BIOS assigns an IRQ to PCI VGA card if the card requests for an IRQ. When set to [No], BIOS does not assign an IRQ to the PCI VGA card even if requested. Configuration options: [No] [Yes]

### Palette Snooping [Disabled]

When set to [Enabled], the palette snooping feature informs the PCI devices that an ISA graphics device is installed in the system so that the latter can function correctly. Configuration options: [Disabled] [Enabled]

## IRQ-xx assigned to [PCI Device]

When set to [PCI Device], the specific IRQ is free for use of PCI/PnP devices.

When set to [Reserved], the IRQ is reserved for legacy ISA devices.

Configuration options: [PCI Device] [Reserved]

## 5.4.5 USB Configuration

The items in this menu allows you to change the USB-related features. Select an item then press <Enter> to display the configuration options.

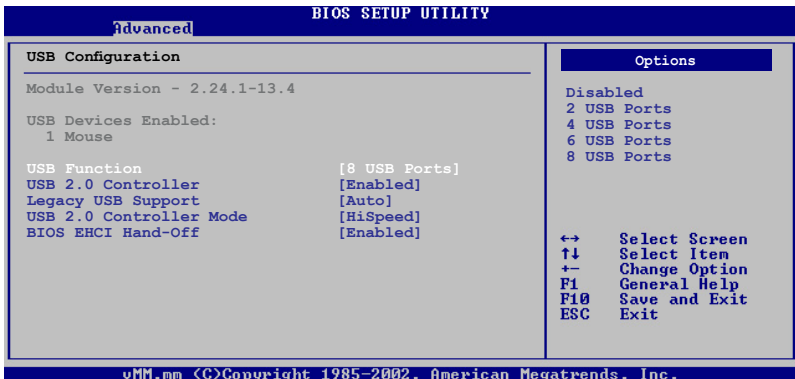

The Module Version and USB Devices Enabled items show the auto-detected values. If no USB device is detected, the item shows None.

### USB Function [8 USB Ports]

Allows you to select the USB function. Configuration options: [Disabled] [2 USB Ports] [4 USB Ports] [6 USB Ports] [8 USB Ports]

### USB 2.0 Controller [Enabled]

Enables or disables the USB 2.0 Controller. Configuration options: [Disabled] [Enabled]

### Legacy USB Support [Auto]

Allows you to enable or disable support for Legacy USB storage devices, including USB flash drives and USB hard drives. Setting to Auto allows the system to detect the presence of USB devices at startup. If detected, the USB controller legacy mode is enabled. If no USB device is detected, the legacy USB support is disabled. Configuration options: [Disabled] [Enabled] [Auto]

**USB 2.0 Controller Mode [HiSpeed]**

Allows you to configure the USB 2.0 controller in HiSpeed (480 Mbps) or Full Speed (12 Mbps). Configuration options: [Full Speed] [HiSpeed]

**BIOS EHCI Hand-Off [Enabled]**

Allows you to configure the BIOS EHCI Hand-Off. Configuration options: [Disabled] [Enabled]

## 5.5 Power menu

The Power menu items allow you to change the settings for the Advanced Configuration and Power Interface (ACPI) and the Advanced Power Management (APM). Select an item then press <Enter> to display the configuration options.

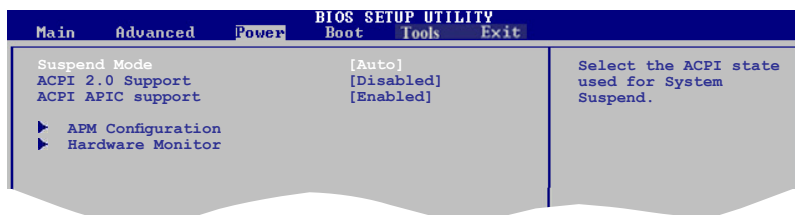

### 5.5.1 Suspend Mode [Auto]

Allows you to select the Advanced Configuration and Power Interface (ACPI) state to be used for system suspend. Configuration options: [S1 (POS) Only] [S3 Only] [Auto]

[S1(POS) Only] - Enables the system to enter the ACPI S1 (Power on Suspend) sleep state. In S1 sleep state, the system appears suspended and stays in a low power mode. The system can be resumed at any time.

[S3 Only] - Enables the system to enter the ACPI S3 (Suspend to RAM) sleep state (default). In S3 sleep state, the system appears to be off and consumes less power than in the S1 state. When signaled by a wake-up device or event, the system resumes to its working state exactly where it was left off.

[Auto] - Detected by OS.

### 5.5.2 ACPI 2.0 Support [Disabled]

Allows you to add more tables for Advanced Configuration as per ACPI 2.0 specifications. Configuration options: [Disabled] [Enabled]

### 5.5.3 ACPI APIC Support [Enabled]

Allows you to enable or disable the Advanced Configuration and Power Interface (ACPI) support in the Application-Specific Integrated Circuit (ASIC). When set to Enabled, the ACPI APIC table pointer is included in the RSDT pointer list. Configuration options: [Disabled] [Enabled]

## 5.5.4 APM Configuration

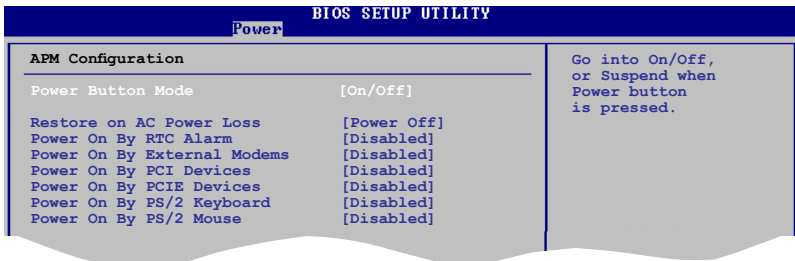

### Power Button Mode [On/Off]

Allows you to set the power button mode. Configuration options: [On/Off] [Suspend]

### Restore on AC Power Loss [Power Off]

When set to Power Off, the system goes into off state after an AC power loss. When set to Power On, the system goes on after an AC power loss. When set to Last State, the system goes into either off or on state, whatever the system state was before the AC power loss. Configuration options: [Power Off] [Power On] [Last State]

### Power On By RTC Alarm [Disabled]

Allows you to enable or disable RTC to generate a wake event. When this item is set to Enabled, the items RTC Alarm Date, RTC Alarm Hour, RTC Alarm Minute, and RTC Alarm Second appear with set values. Configuration options: [Disabled] [Enabled]

### Power On By External Modems [Disabled]

This allows either settings of [Enabled] or [Disabled] for powering up the computer when the external modem receives a call while the computer is in Soft-off mode. Configuration options: [Disabled] [Enabled]



The computer cannot receive or transmit data until the computer and applications are fully running. Thus, connection cannot be made on the first try. Turning an external modem off and then back on while the computer is off causes an initialization string that turns the system power on.

### Power On By PCI Devices [Disabled]

When set to [Enabled], this parameter allows you to turn on the system through a PCI LAN or modem card. This feature requires an ATX power supply that provides at least 1A on the +5VSB lead. Configuration options: [Disabled] [Enabled]



### **Power On By PCIE Devices [Disabled]**

When set to [Enabled], this parameter allows you to turn on the system through a PCI Express card. This feature requires an ATX power supply that provides at least 1A on the +5VSB lead. Configuration options: [Disabled] [Enabled]

### **Power On By PS/2 Keyboard [Disabled]**

Allows you to use specific keys on the keyboard to turn on the system. This feature requires an ATX power supply that provides at least 1A on the +5VSB lead. Configuration options: [Disabled] [Enabled]

### **Power On By PS/2 Mouse [Disabled]**

When set to [Enabled], this parameter allows you to use the PS/2 mouse to turn on the system. This feature requires an ATX power supply that provides at least 1A on the +5VSB lead. Configuration options: [Disabled] [Enabled]

## 5.5.5 Hardware Monitor

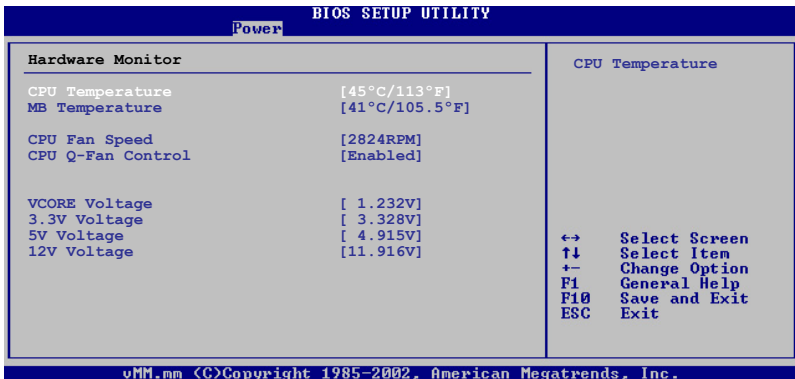

### CPU Temperature [xxx°C/xxx°F]

### MB Temperature [xxx°C/xxx°F]

The onboard hardware monitor automatically detects and displays the CPU / MB temperature. Select Ignored if you do not wish to display the detected temperature.

### CPU Fan Speed [xxxxRPM] or [Ignored]

The onboard hardware monitor automatically detects and displays the CPU fan speed in rotations per minute (RPM). If the fan is not connected to the motherboard, the field shows N/A. Select Ignored if you do not wish to display the detected speed.

### CPU Q-Fan Control [Enabled]

Allows you to enable or disable the CPU Q-Fan control.  
Configuration options: [Disabled] [Enabled]

### VCORE Voltage, 3.3V Voltage, 5V Voltage, 12V Voltage

The onboard hardware monitor automatically detects the voltage output through the onboard voltage regulators.

## 5.6 Boot menu

The Boot menu items allow you to change the system boot options. Select an item then press <Enter> to display the sub-menu.

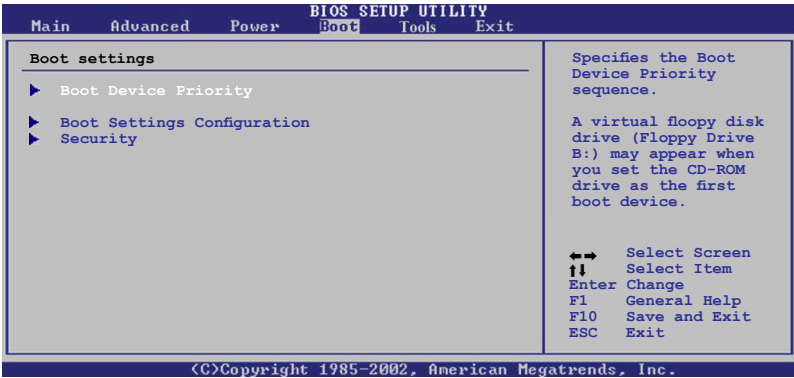

### 5.6.1 Boot Device Priority

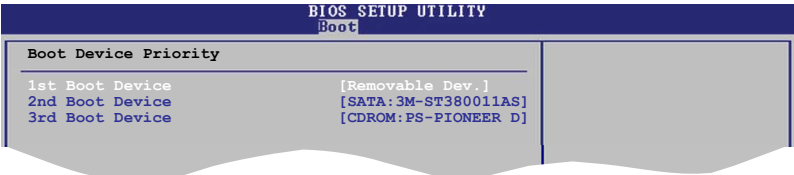

#### 1st ~ xxth Boot Device [Removable Dev.]

These items specify the boot device priority sequence from the available devices. The number of device items that appears on the screen depends on the number of devices installed in the system. Configuration options: [Removable Dev.] [Hard Drive] [ATAPI CD-ROM ] [Disabled]

## 5.6.2 Boot Settings Configuration

BIOS SETUP UTILITY	
Boot	
Boot Settings Configuration	
Quick Boot	[Enabled]
Full Screen Logo	[Enabled]
AddOn ROM Display Mode	[Force BIOS]
Bootup Num-Lock	[On]
PS/2 Mouse Support	[Auto]
Wait For 'F1' If Error	[Enabled]
Hit 'DEL' Message Display	[Enabled]
Interrupt 19 Capture	[Disabled]

Allows BIOS to skip certain tests while booting. This will decrease the time needed to boot the system.

### Quick Boot [Enabled]

Enabling this item allows the BIOS to skip some power on self tests (POST) while booting to decrease the time needed to boot the system. When set to [Disabled], BIOS performs all the POST items. Configuration options: [Disabled] [Enabled]

### Full Screen Logo [Enabled]

This allows you to enable or disable the full screen logo display feature. Configuration options: [Disabled] [Enabled]



Set this item to **[Enabled]** to use the ASUS MyLogo 2™ feature.

### Add On ROM Display Mode [Force BIOS]

Sets the display mode for option ROM. Configuration options: [Force BIOS] [Keep Current]

### Bootup Num-Lock [On]

Allows you to select the power-on state for the NumLock. Configuration options: [Off] [On]

### PS/2 Mouse Support [Auto]

Allows you to enable or disable support for PS/2 mouse. Configuration options: [Disabled] [Enabled] [Auto]

### Wait for 'F1' If Error [Enabled]

When set to Enabled, the system waits for the F1 key to be pressed when error occurs. Configuration options: [Disabled] [Enabled]

### Hit 'DEL' Message Display [Enabled]

When set to Enabled, the system displays the message "Press DEL to run Setup" during POST. Configuration options: [Disabled] [Enabled]

## Interrupt 19 Capture [Disabled]

When set to [Enabled], this function allows the option ROMs to trap Interrupt 19.  
Configuration options: [Disabled] [Enabled]

### 5.6.3 Security

The Security menu items allow you to change the system security settings. Select an item then press <Enter> to display the configuration options.

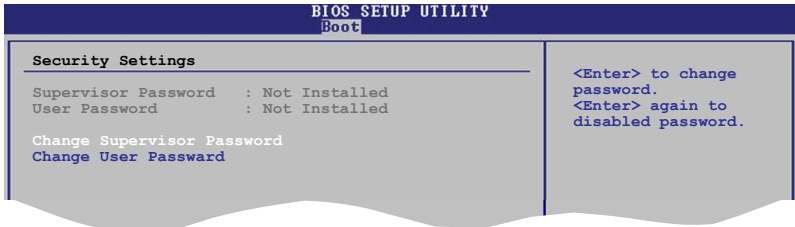

### Change Supervisor Password

Select this item to set or change the supervisor password. The Supervisor Password item on top of the screen shows the default Not Installed. After you set a password, this item shows Installed.

To set a Supervisor Password:

1. Select the Change Supervisor Password item and press <Enter>.
2. From the password box, type a password composed of at least six letters and/or numbers, then press <Enter>.
3. Confirm the password when prompted.

The message "Password Installed" appears after you successfully set your password.

To change the supervisor password, follow the same steps as in setting a user password.

To clear the supervisor password, select the Change Supervisor Password then press <Enter>. The message "Password Uninstalled" appears.



If you forget your BIOS password, you can clear it by erasing the CMOS Real Time Clock (RTC) RAM. See section "4.3 Jumpers" for information on how to erase the RTC RAM.

After you have set a supervisor password, the other items appear to allow you to change other security settings.

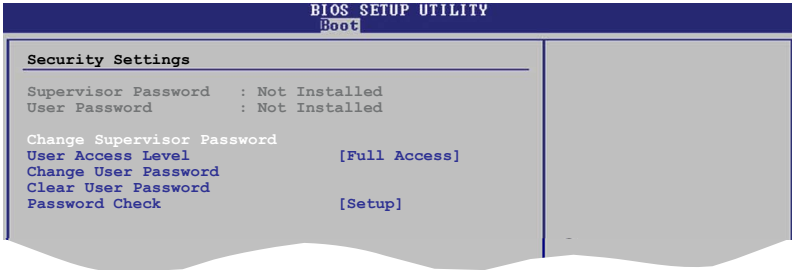

### User Access Level [Full Access]

This item allows you to select the access restriction to the Setup items.  
Configuration options: [No Access] [View Only] [Limited] [Full Access]

No Access prevents user access to the Setup utility.

View Only allows access but does not allow change to any field.

Limited allows changes only to selected fields, such as Date and Time.

Full Access allows viewing and changing all the fields in the Setup utility.

### Change User Password

Select this item to set or change the user password. The User Password item on top of the screen shows the default Not Installed. After you set a password, this item shows Installed.

To set a User Password:

1. Select the Change User Password item and press <Enter>.
2. On the password box that appears, type a password composed of at least six letters and/or numbers, then press <Enter>.
3. Confirm the password when prompted.

The message "Password Installed" appears after you set your password successfully.

To change the user password, follow the same steps as in setting a user password.

### Clear User Password

Select this item to clear the user password.

### Password Check [Setup]

When set to [Setup], BIOS checks for user password when accessing the Setup utility. When set to [Always], BIOS checks for user password both when accessing Setup and booting the system. Configuration options: [Setup] [Always]

## 5.7 Tools menu

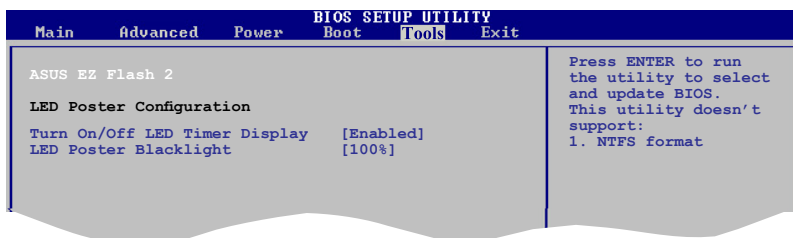

### 5.7.1 ASUS EZ Flash 2

Allows you to run ASUS EZ Flash 2. When you press <Ok>, a confirmation message appears. Use the left/right arrow key to select between [Yes] or [No], then press <Ok> to confirm your choice.

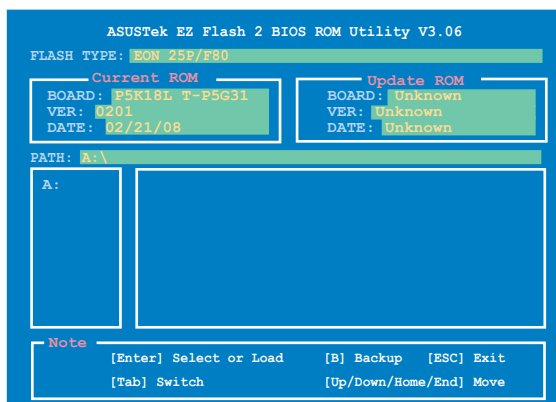

The following items appear only in some models with LED Display features.

### 5.7.2 Turn On / Off LED Timer Display [Enabled]

Allows you to enable or disable the LED Timer Display feature. Configuration options: [Enabled] [Disabled]

### 5.7.3 LED Poster Backlight [100%]

Allows you to set the LED poster backlight. Configuration options: [25%] [50%] [75%] [100%]

## 5.8 Exit menu

The Exit menu items allow you to load the optimal or failsafe default values for the BIOS items, and save or discard your changes to the BIOS items.

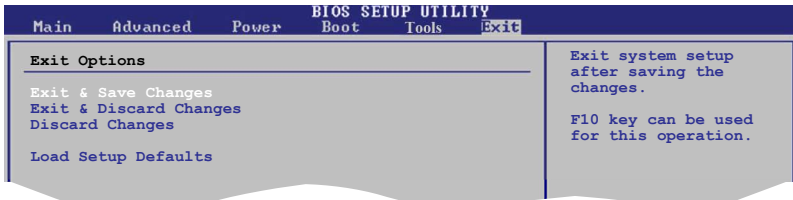

Pressing <Esc> does not immediately exit this menu. Select one of the options from this menu or <F10> from the legend bar to exit.

### Exit & Save Changes

Once you are finished making your selections, choose this option from the Exit menu to ensure the values you selected are saved to the CMOS RAM. An onboard backup battery sustains the CMOS RAM so it stays on even when the PC is turned off. When you select this option, a confirmation window appears. Select **OK** to save changes and exit.



If you attempt to exit the Setup program without saving your changes, the program prompts you with a message asking if you want to save your changes before exiting. Press <Enter> to save the changes while exiting.

### Exit & Discard Changes

Select this option only if you do not want to save the changes that you made to the Setup program. If you made changes to fields other than System Date, System Time, and Password, the BIOS asks for a confirmation before exiting.

### Discard Changes

This option allows you to discard the selections you made and restore the previously saved values. After selecting this option, a confirmation appears. Select **OK** to discard any changes and load the previously saved values.

### Load Setup Defaults

This option allows you to load the default values for each of the parameters on the Setup menus. When you select this option or if you press <F5>, a confirmation window appears. Select **OK** to load default values. Select **Exit & Save Changes** or make other changes before saving the values to the non-volatile RAM.



# Appendix

The Appendix includes the power supply unit specification for this system.



**T3-P5G31**

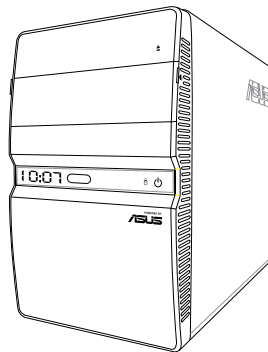

**T4-P5G31\***

\* Only some of the T4 models have the Time and IR LED display.

## A.1 Power supply specifications

### Output characteristics

Output voltage	Load range		Surge <10ms	Regulation (%)	Ripple and noise	
	Min	Max			Vpp	Vpp & noise
+5V	0.3A	18A		-5% ~ +5%	50mV	70mV
+3.3V	0.3A	16A		-5% ~ +5%	50mV	70mV
+12V1	1A	10A	12A	-5% ~ +5%	150mV	150mV
+12V2	1A	14A	18A	-5% ~ +5%	150mV	150mV
-12V	0A	0.3A		-10% ~ +10%	200mV	200mV
+5VSB	0.1A	2.5A		-5% ~ +5%	50mV	70mV

## A.2 Debug code table

Code	Description
CPU	CPU initiation Test CMOS R/W functionality
CHIP	Early chipset initialization: <ul style="list-style-type: none"><li>- Disable shadow RAM</li><li>- Disable L2 cache</li><li>- Program basic chipset registers</li></ul>
ddr	Detect memory: <ul style="list-style-type: none"><li>- Auto-detection of DRAM size, type and ECC</li><li>- Auto-detection of L2 cache</li></ul>
H A	Initialize Hardware Monitor
SIO	1. Test special keyboard controller for Super I/O chips 2. Enable keyboard interface
CL-	Initialize clock generator
USb	Initialize USB
PS2	Initialize PS/2 Mouse
FAn	Fan error
OS	Boot attempt (INT 19h)

### A.3 Using the Remote Control (optional)

Use the remote control to launch the Media Center program to play media files such as music and movies. You can also install an external TV box to watch TV and record TV programs.

Refer to the table below to familiarize yourself with the functions of the remote control buttons.

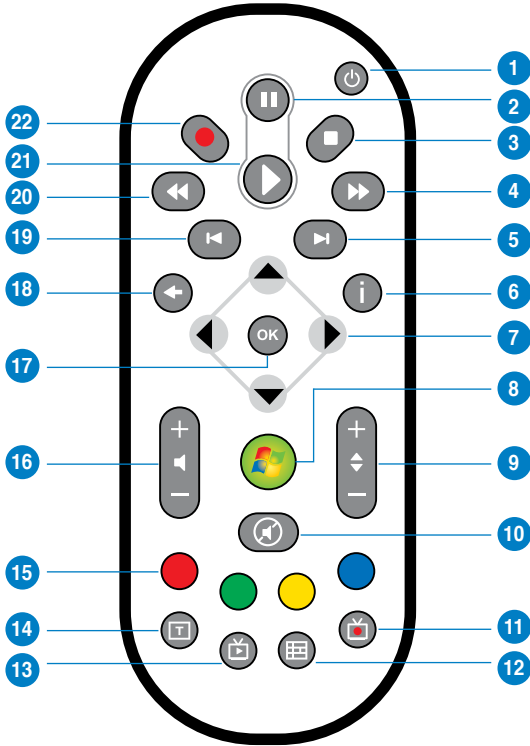

No.	Button	Description
1.	Power	Press to turn on/off the power of the screen and the speakers.
2.	Pause	Press to pause a playback.
3.	Stop	Press to stop playing a media file.

(continued on the next page)

No.	Button	Description
4.	Fast-forward	Press to fast-forward a media file.
5.	Next track	Press to go to the next track.
6.	Information	Press to display program information under Media Center or other menu options.
7.	Four-way navigation keys	Press to scroll through on-screen display menus.
8.	Windows® Media Center	Press to launch the Media Center program.
9.	Channel up/down	Press to change TV channels.*
10.	Mute	Press to disable audio output.
11.	Recorded TV	Press to display a list of your recorded TV programs.*
12.	EPG (Electronic Program Guide)	Press to display the electronic program guide screen.*
13.	Live TV button	Press to watch live TV programs. *
14.	Shift	Toggles between numerical and alphabetical input.
15.	Teletext buttons	Available on European models only.
16.	Volume up/down	Press to increase/decrease the volume.
17.	OK	Press to confirm an action.
18.	Return	Press to return to the previous page.
19.	Previous track	Press to go back to the previous track.
20.	Rewind	Press to rewind a media file.
21.	Play	Press to play a media file.
22.	Record	Press to start recording TV.

\* The system does not come with built-in TV tuner. To use the TV function, purchase an external TV box first.