

ASUS® AB-P2800

Book Size Barebone System

User Guide



E1611

Revised Edition V2

May 2004

Copyright © 2004 ASUSTeK COMPUTER INC. All Rights Reserved.

No part of this manual, including the products and software described in it, may be reproduced, transmitted, transcribed, stored in a retrieval system, or translated into any language in any form or by any means, except documentation kept by the purchaser for backup purposes, without the express written permission of ASUSTeK COMPUTER INC. ("ASUS").

Product warranty or service will not be extended if: (1) the product is repaired, modified or altered, unless such repair, modification or alteration is authorized in writing by ASUS; or (2) the serial number of the product is defaced or missing.

ASUS PROVIDES THIS MANUAL "AS IS" WITHOUT WARRANTY OF ANY KIND, EITHER EXPRESS OR IMPLIED, INCLUDING BUT NOT LIMITED TO THE IMPLIED WARRANTIES OR CONDITIONS OF MERCHANTABILITY OR FITNESS FOR A PARTICULAR PURPOSE. IN NO EVENT SHALL ASUS, ITS DIRECTORS, OFFICERS, EMPLOYEES OR AGENTS BE LIABLE FOR ANY INDIRECT, SPECIAL, INCIDENTAL, OR CONSEQUENTIAL DAMAGES (INCLUDING DAMAGES FOR LOSS OF PROFITS, LOSS OF BUSINESS, LOSS OF USE OR DATA, INTERRUPTION OF BUSINESS AND THE LIKE), EVEN IF ASUS HAS BEEN ADVISED OF THE POSSIBILITY OF SUCH DAMAGES ARISING FROM ANY DEFECT OR ERROR IN THIS MANUAL OR PRODUCT.

SPECIFICATIONS AND INFORMATION CONTAINED IN THIS MANUAL ARE FURNISHED FOR INFORMATIONAL USE ONLY, AND ARE SUBJECT TO CHANGE AT ANY TIME WITHOUT NOTICE, AND SHOULD NOT BE CONSTRUED AS A COMMITMENT BY ASUS. ASUS ASSUMES NO RESPONSIBILITY OR LIABILITY FOR ANY ERRORS OR INACCURACIES THAT MAY APPEAR IN THIS MANUAL, INCLUDING THE PRODUCTS AND SOFTWARE DESCRIBED IN IT.

Products and corporate names appearing in this manual may or may not be registered trademarks or copyrights of their respective companies, and are used only for identification or explanation and to the owners' benefit, without intent to infringe.

Table of contents

Notices	6
Safety information	7
About this guide	8
System package contents	10
Chapter 1: System introduction	
1.1 Welcome!	12
1.2 Front panel (external)	12
1.3 Front panel (internal)	13
1.4 Rear panel	14
1.5 Internal components	16
1.6 System dimension	16
Chapter 2: Basic installation	
2.1 Preparation	18
2.2 Before you proceed	18
2.3 Removing the cover	19
2.4 Removing the storage drive assembly	20
2.5 Installing a CPU	21
2.5.1 Removing the CPU fan and heatsink assembly	21
2.5.2 CPU installation	23
2.5.3 Re-installing the CPU fan and heatsink assembly	24
2.6 Installing memory modules	26
2.6.1 Overview	26
2.6.2 Memory configurations	26
2.6.3 Qualified Vendor List	27
2.6.4 Installing a DIMM	27
2.6.5 Removing a DIMM	28
2.7 Installing PCI cards	29
2.7.1 PCI slots	29
2.7.2 PCI card installation	29
2.7.3 Configuring an expansion card	31
2.8 Installing storage drives	32
2.8.1 Installing an IDE hard disk drive	32
2.8.2 Installing a Serial ATA hard disk drive	34
2.8.3 Installing an optical drive	35

Table of contents

2.9	Replacing the cover	39
2.10	Removing and re-installing the foot stand	40
2.10.1	Removing the foot stand	40
2.10.2	Re-installing the foot stand	41
2.11	Power supply unit information	42
2.11.1	Voltage selector	42
2.11.2	Power supply specifications	43
2.12	Connecting devices	44

Chapter 3: Starting up

3.1	Installing an operating system	48
3.2	Powering up	49
3.3	Using the system	49
3.3.1	PCMCIA card slot	49
3.3.2	Storage card slot	50
3.3.3	Optical drive	50
3.4	Support CD information	51
3.4.1	Running the support CD	51
3.4.2	Drivers menu	51
3.4.3	Utilities	52
3.4.4	ASUS contact information	53
3.5	ATI IGP Catalyst™	54
3.5.1	Left-click menu	54
3.5.2	Right-click menu	54
3.5.3	Managing multiple displays	55
3.6	Multi-channel audio feature	57

Chapter 4: Motherboard information

4.1	Introduction	62
4.2	Motherboard layout	62
4.3	Jumper	63
4.4	Internal connectors	65

Chapter 5: BIOS setup

5.1	Managing and updating your BIOS	72
5.1.1	Recovering the BIOS with CrashFree BIOS 2	72
5.1.2	ASUS Update	74

Table of contents

5.2	BIOS Setup program	76
5.2.1	BIOS menu screen	77
5.2.2	Menu bar	77
5.2.3	Navigation keys	77
5.2.4	Menu items	78
5.2.5	Sub-menu items	78
5.2.6	Configuration fields	78
5.2.7	Pop-up window	78
5.2.8	Scroll bar	78
5.2.9	General help	78
5.3	Main menu	79
5.3.1	System Time	79
5.3.2	System Date	79
5.3.3	Primary IDE Master/Slave; Serial ATA Master	80
5.3.4	System Information	81
5.4	Advanced menu	82
5.4.1	CPU Configuration	82
5.4.2	Chipset	83
5.4.3	Onboard Devices Configuration	85
5.4.4	PCIPnP	86
5.5	Power menu	88
5.5.1	Suspend Mode	88
5.5.2	Repost Video on S3 Resume	88
5.5.3	ACPI 2.0 Support	88
5.5.4	ACPI APIC Support	88
5.5.5	APM Configuration	89
5.5.6	Hardware Monitor	90
5.6	Boot menu	92
5.6.1	Boot Device Priority	92
5.6.2	Boot Settings Configuration	93
5.6.3	Security	94
5.7	Exit menu	97

Notices

Federal Communications Commission Statement

This device complies with Part 15 of the FCC Rules. Operation is subject to the following two conditions:

- This device may not cause harmful interference, and
- This device must accept any interference received including interference that may cause undesired operation.

This equipment has been tested and found to comply with the limits for a Class B digital device, pursuant to Part 15 of the FCC Rules. These limits are designed to provide reasonable protection against harmful interference in a residential installation. This equipment generates, uses and can radiate radio frequency energy and, if not installed and used in accordance with manufacturer's instructions, may cause harmful interference to radio communications. However, there is no guarantee that interference will not occur in a particular installation. If this equipment does cause harmful interference to radio or television reception, which can be determined by turning the equipment off and on, the user is encouraged to try to correct the interference by one or more of the following measures:

- Reorient or relocate the receiving antenna.
- Increase the separation between the equipment and receiver.
- Connect the equipment to an outlet on a circuit different from that to which the receiver is connected.
- Consult the dealer or an experienced radio/TV technician for help.



WARNING! The use of shielded cables for connection of the monitor to the graphics card is required to assure compliance with FCC regulations. Changes or modifications to this unit not expressly approved by the party responsible for compliance could void the user's authority to operate this equipment.

Canadian Department of Communications Statement

This digital apparatus does not exceed the Class B limits for radio noise emissions from digital apparatus set out in the Radio Interference Regulations of the Canadian Department of Communications.

This class B digital apparatus complies with Canadian ICES-003.

Safety information

Electrical safety

- To prevent electrical shock hazard, disconnect the power cable from the electrical outlet before relocating the system.
- When adding or removing devices to or from the system, ensure that the power cables for the devices are unplugged before the signal cables are connected.
- If the power supply is broken, do not try to fix it by yourself. Contact a qualified service technician or your retailer.

Operation safety

- Before installing devices into the system, carefully read all the documentation that came with the package.
- Before using the product, make sure all cables are correctly connected and the power cables are not damaged. If you detect any damage, contact your dealer immediately.
- To avoid short circuits, keep paper clips, screws, and staples away from connectors, slots, sockets and circuitry.
- Avoid dust, humidity, and temperature extremes. Do not place the product in any area where it may become wet. Place the product on a stable surface.
- If you encounter technical problems with the product, contact a qualified service technician or your retailer.

Lithium-Ion Battery Warning

CAUTION: Danger of explosion if battery is incorrectly replaced. Replace only with the same or equivalent type recommended by the manufacturer. Dispose of used batteries according to the manufacturer's instructions.

VORSICHT: Explosionsgefahr bei unsachgemäßen Austausch der Batterie. Ersatz nur durch denselben oder einem vom Hersteller empfohlenem ähnlichen Typ. Entsorgung gebrauchter Batterien nach Angaben des Herstellers.

LASER PRODUCT WARNING

CLASS 1 LASER PRODUCT

About this guide

Audience

This guide provides general information and installation instructions about the ASUS book size barebone system. This guide is intended for experienced users and integrators with hardware knowledge of personal computers.

How this guide is organized

This guide contains the following parts:

1. **Chapter 1: System introduction**

This chapter gives a general description of the ASUS book size barebone system. The chapter lists the system features including an introduction of the front and rear panels, and internal components.

2. **Chapter 2: Basic installation**

This chapter provides step-by-step instructions on how to install components to the system.

3. **Chapter 3: Starting up**

This chapter tells you how to turn on the system and install the drivers and utilities from the support CD. This chapter also describes the software applications that the system supports.

4. **Chapter 4: Motherboard information**

This chapter provides information on the pre-installed system motherboard. This chapter includes the motherboard layout, jumper settings, and connector locations.

5. **Chapter 5: BIOS setup**

This chapter tells how to change system settings through the BIOS Setup menus and describes the BIOS parameters.

Conventions used in this guide



WARNING: Information to prevent injury to yourself when trying to complete a task.



CAUTION: Information to prevent damage to the components when trying to complete a task.



IMPORTANT: Information that you **MUST** follow to complete a task.



NOTE: Tips and additional information to aid in completing a task.

Where to find more information

Refer to the following sources for additional information and for product and software updates.

1. **ASUS websites**

The ASUS websites worldwide provide updated information on ASUS hardware and software products. Refer to the ASUS contact information.

2. **Optional documentation**

Your product package may include optional documentation, such as warranty flyers, that may have been added by your dealer. These documents are not part of the standard package.

System package contents

Check your book size barebone system package for the following items.

1. ASUS book size barebone system with:

- ASUS P4R8L motherboard
- CPU fan and heatsink assembly
- PCMCIA slot
- 4-in-1 storage card reader
- PCI riser card
- 200W power supply unit

2. Cables

- Power cable and plug
- Serial ATA signal cable
- Serial ATA power cable

3. Support CD

4. User guide

5. Optional component(s)

- Security port with two security keys
- Optical drive*

**CD-ROM/CD-RW/DVD-ROM/DVD-RW*



Contact your retailer immediately if any of the items is damaged or missing.

Chapter 1

This chapter gives a general description of the ASUS book size barebone system. The chapter lists the system features including an introduction of the front and rear panels, and internal components.



ASUS AB-P2800 book size barebone system

System introduction

1.1 Welcome!

Thank you for choosing the ASUS book size barebone system!

The ASUS book size barebone system is a union of power, design, and performance built on ASUS technology and innovation. Inside the elegant silver casing is the ASUS P4R8L motherboard that supports Intel® Pentium® 4 processor with up to 800MHz front side bus (FSB), and up to 2GB system memory.

This system features a complete array of multimedia capabilities and seamless connectivity including dual display function, Fast Ethernet, 4-in-1 card reader, PCMCIA, USB, S/PDIF, and IEEE 1394 interfaces.

The ergonomic design, silent operation, and cost effective architecture of the ASUS book size barebone system makes it an ideal solution for your multimedia and computing needs.

1.2 Front panel (external)

The front panel includes the system and audio control buttons, system LEDs, and LED panel.

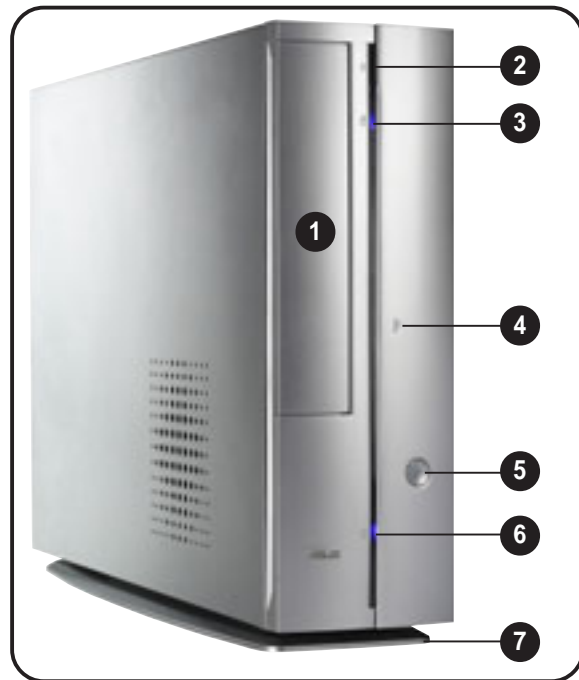

1. **Optical drive door.** This door opens when you eject the loading tray.
2. **Eject button** ▲. Press this button to eject the loading tray of the optical drive.
3. **HDD LED** 🗄️. This LED lights up when data is being read from or written to the hard disk drive.
4. **Front panel I/O door.** Open this door to show the front panel input/output ports.
5. **Power button** ⏻. Press this button to turn the system on.
6. **Power LED** 🔆. When lit, this LED indicates that the system is ON.
7. **Foot stand.** The foot stand allows you to place the system in a vertical position. See page 40 for details.



1.3 Front panel (internal)





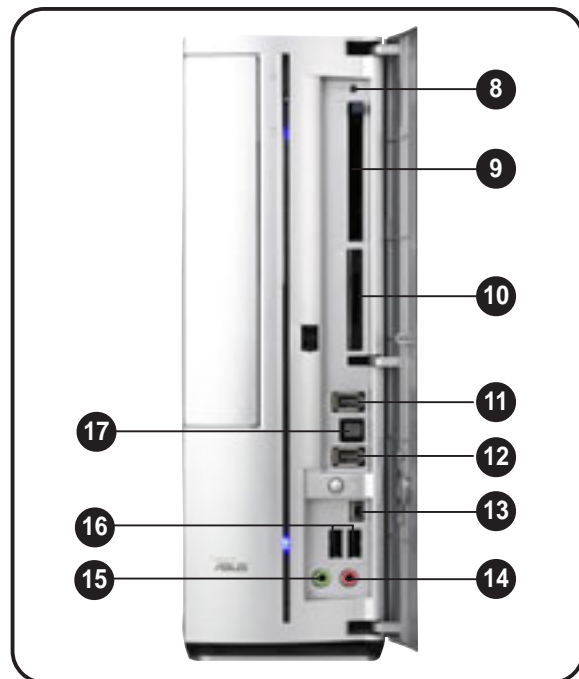

The optical drive, storage card reader, PCMCIA slot, and several I/O ports are located inside the front panel door.

Open the front panel doors by pressing the **PUSH** mark.

8. **Reset button** . Press this button to reset the system.
9. **PCMCIA slot** . This slot is for a PCMCIA-compliant card. See page 49 for details.
10. **4-in-1 card slot** . This slot is for a storage cards.



You can not close the front panel I/O door if a storage card is inserted in any of the card slots.

11. **HDD security lock** *(optional)*. This port allows you to lock the HDD data with the supplied security key. See page 48 for details.
12. **6-pin IEEE 1394 port** . This port provides high-speed connectivity for IEEE 1394-compliant audio/video devices, storage peripherals, and other PC devices.
13. **4-pin IEEE 1394 port** . This port provides high-speed connectivity for IEEE 1394-compliant audio/video devices, storage peripherals, and other PC devices.
14. **Microphone port** . This Mic (pink) port connects a microphone.
15. **Headphone port** . This port connects a headphone with a stereo mini-plug.
16. **USB 2.0 ports** . These Universal Serial Bus 2.0 (USB 2.0) ports are available for connecting USB 2.0 devices such as a mouse, printer, scanner, camera, PDA, and others.
17. **Optical S/PDIF port** . This port connects your audio system for 5.1-channel surround sound and enhanced 3D audio.

1.4 Rear panel

The system rear panel includes the power socket and several I/O ports that allow convenient connection of devices.

1. **Voltage selector.** This switch allows you to select the appropriate voltage supply in your area. See the “Voltage selector” section on page 42 before adjusting this switch.
2. **Power supply unit.** This is a 200W power supply unit.
3. **S-Video port** [S-Video icon]. This port connects a video cassette recorder, camcorder, or television with S-Video interface.
4. **TV-out port.** This port connects a television.
5. **PS/2 mouse port** [PS/2 mouse icon]. This green 6-pin connector is for a PS/2 mouse.
6. **Ethernet LAN port** [LAN icon]. This port allows connection to a Local Area Network (LAN) through a network hub.
7. **Parallel port** [Parallel icon]. This 25-pin port connects a printer, scanner, or other devices.
8. **PCI slots.** These PCI slots (covered) are for PCI-compliant cards.
9. **Serial port** [Serial icon]. This port connects a mouse, modem, or other devices that conforms with serial specification.
10. **VGA port** [VGA icon]. This port connects a VGA monitor.
11. **DVI port.** This port connects a flat panel or LCD display.
12. **USB 2.0 ports** [USB 2.0 icon]. These Universal Serial Bus 2.0 (USB 2.0) ports are available for connecting USB 2.0 devices such as a mouse, printer, scanner, camera, PDA, and others.

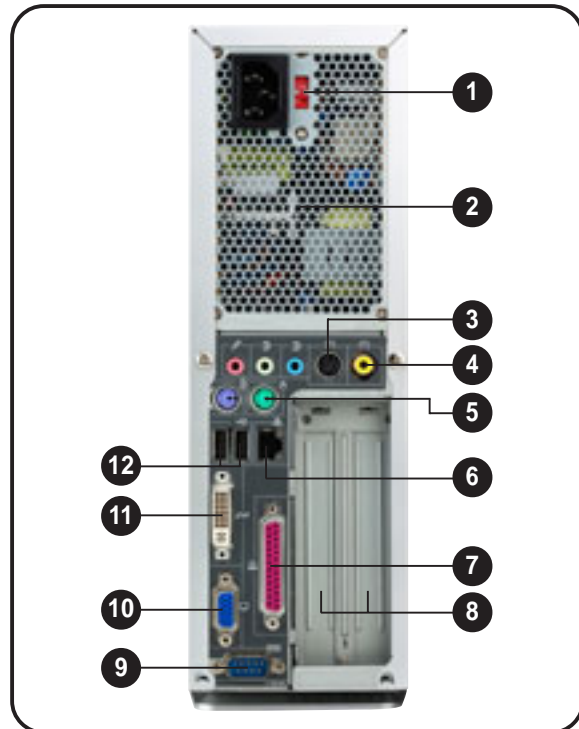

13. PS/2 keyboard port . This purple 6-pin connector is for a PS/2 keyboard.

14. Microphone port . This Microphone (pink) port connects a microphone. In 4/6-channel mode, the function of this port becomes Surround Speaker.

15. Line Out port . This Line Out (lime) port connects a headphone or a speaker. In 4/6-channel mode, the function of this port becomes Front Speaker Out.

16. Line In port . This Line In (light blue) port connects a tape player or other audio sources. In 6-channel mode, the function of this port becomes Low Frequency Enhanced Output/Center.

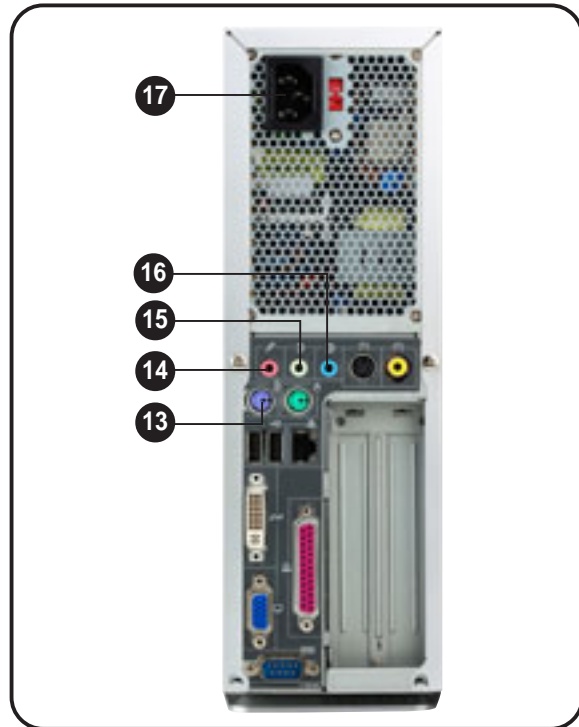

The functions of the Line Out (lime), Line In (blue), and Microphone (pink) ports change when you select the 4-channel or 6-channel audio configuration as shown in the table below.

Audio ports function variation

Port	Headphone/2-Channel	4-Channel	6-Channel
Blue	Line In	No function	LFE Output*/Center
Lime	Line Out	Front Speaker Out	Front Speaker Out
Pink	Mic In	Surround	Surround

* *Low Frequency Enhanced Output*

17. Power socket. This socket connects the power cable and plug.

1.5 Internal components

The illustration below is the internal view of the system when you remove the cover and the CPU fan duct. The installed components are labeled for your reference. Proceed to Chapter 2 for instructions on installing other system components.

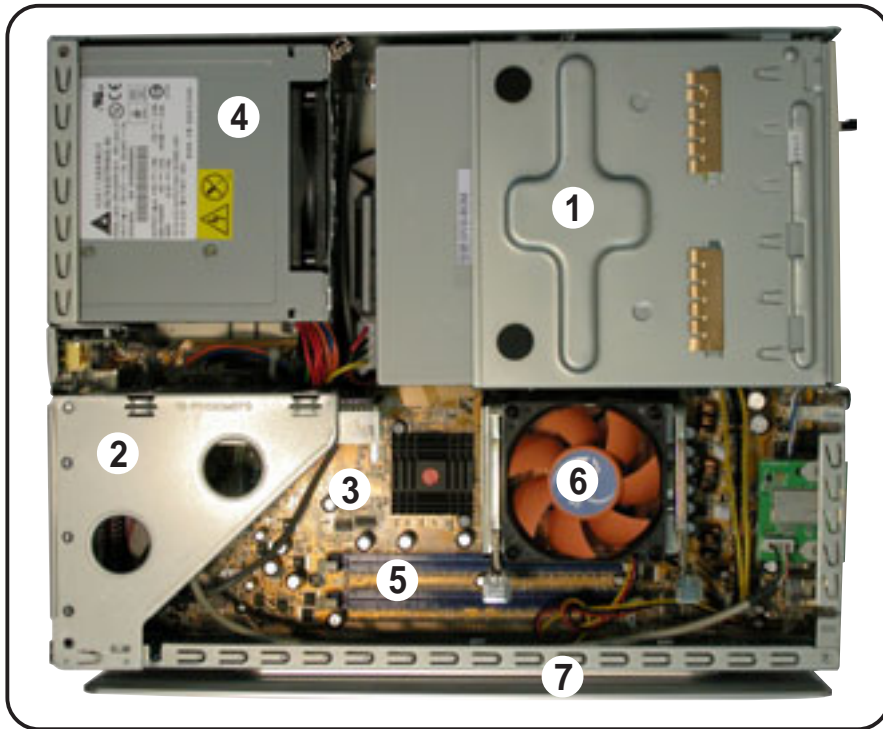

- | | |
|---------------------------|----------------------------------|
| 1. Storage drive assembly | 5. DIMM sockets |
| 2. PCI riser | 6. CPU fan and heatsink assembly |
| 3. ASUS P4R8L motherboard | 7. Foot stand |
| 4. Power supply unit | |

1.6 System dimension

The ASUS booksize barebone system is ergonomically designed to fit and complement your desktop.

You may use the foot stand to place the system vertically on a flat, stable surface.

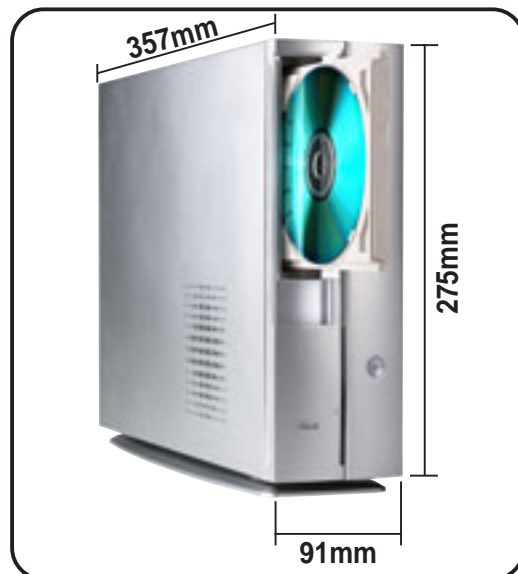

Chapter 2

This chapter provides step-by-step instructions on how to install components to the system.



ASUS AB-P2800 book size barebone system

Basic installation

2.1 Preparation

Before you proceed, make sure that you have all the components that you plan to install in the system.

Basic components to install

1. Central processing unit (CPU)
2. DDR Dual Inline Memory Module (DIMM)
3. Expansion card(s)
4. Hard disk drive
5. Optical drive

Tool

Phillips (cross) screw driver

2.2 Before you proceed

Take note of the following precautions before you install components into the system.



- Use a grounded wrist strap or touch a safely grounded object or to a metal object, such as the power supply case, before handling components to avoid damaging them due to static electricity.
- Hold components by the edges to avoid touching the ICs on them.
- Whenever you uninstall any component, place it on a grounded antistatic pad or in the bag that came with the component.

The system motherboard comes with an onboard standby power LED. When lit, this LED indicates that the system is ON, in sleep mode or in soft-off mode, and not powered OFF. Unplug the power cable from the power outlet and make sure that the standby power LED is OFF before installing any system component.

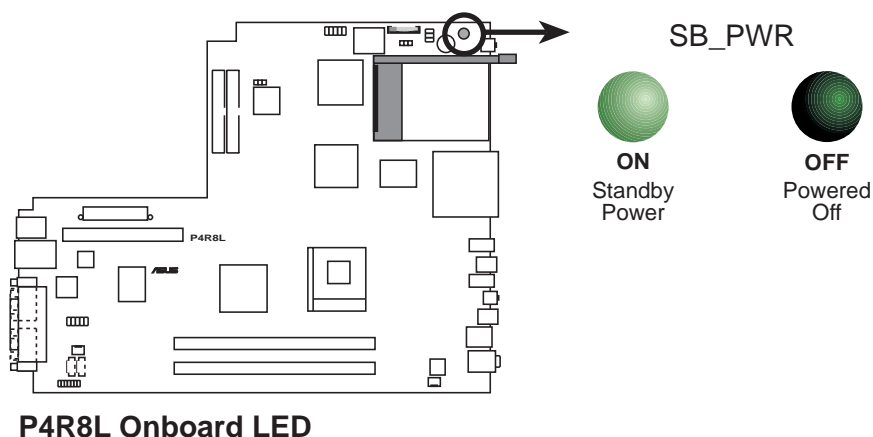

2.3 Removing the cover

To remove the cover:

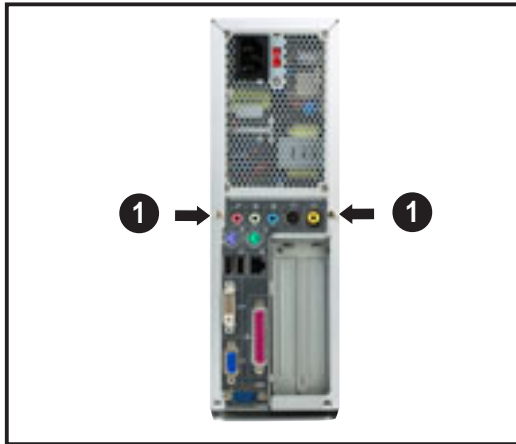

1. On the rear panel, locate the two screws that secure the cover to the chassis.

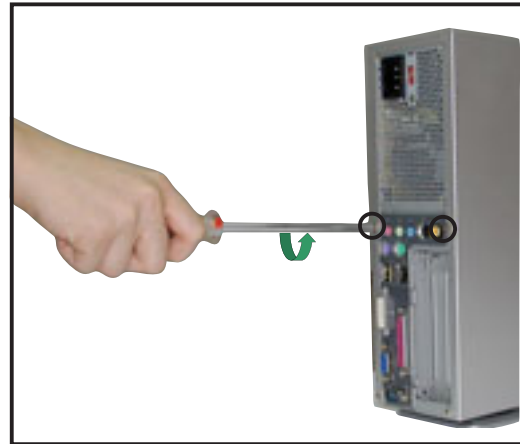

2. Use a Phillips (cross) screw driver to remove the cover screws. Keep the screws for later use.

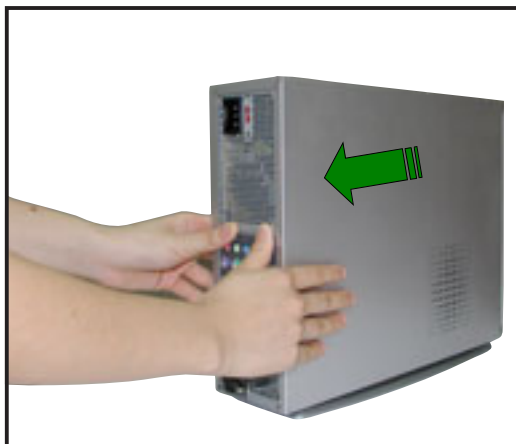

3. Pull the cover slightly toward the rear panel until the cover tabs disengage from the chassis.

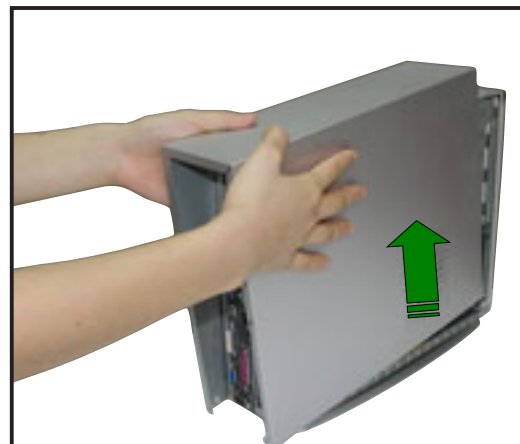

4. Lift the cover, then set aside.

2.4 Removing the storage drive assembly

Removing the storage drive assembly provides you more space when installing the CPU and the CPU fan and heatsink assembly.

To remove the front cover and storage drive assembly:

1. Lift the front cover hooks outward until they disengage from the chassis.
2. Carefully remove the front cover, then set it aside.

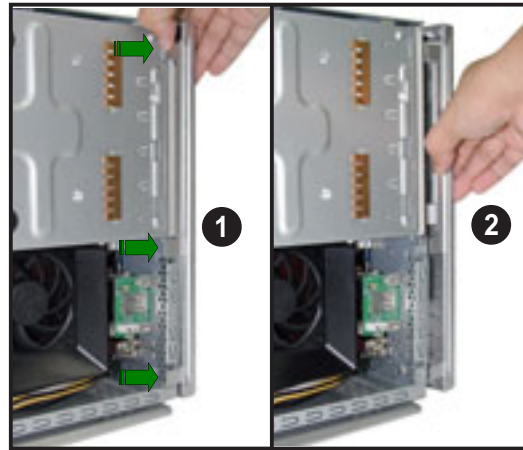

3. Lay the system on its side on a flat and stable surface.
4. Locate and remove three storage drive assembly screws. Keep the screws for later use.



If your system comes with a pre-installed optical drive, disconnect the power, audio, and IDE plugs at the back of the drive before lifting the storage drive assembly.

5. Slightly lift the storage drive assembly until its hooks are released from the chassis holes. Set the storage drive assembly aside.



When removing the storage drive assembly, make sure to hold or support it firmly. The assembly may accidentally drop and damage other system components.

2.5 Installing a CPU

The P4R8L motherboard comes with a surface mount 478-pin Zero Insertion Force (ZIF) socket specifically designed for Intel® Pentium® 4 processor. You need to remove the CPU fan duct and heatsink assembly before you could install a CPU.

2.5.1 Removing the CPU fan and heatsink assembly

The system package includes a pre-installed proprietary CPU fan and heatsink assembly with a fan duct to provide an efficient thermal solution to the system.



Do not replace the proprietary CPU fan and heatsink with other models.

1. Locate the CPU fan and heatsink assembly.
2. Remove the two screws that secure the fan duct on the CPU fan and heatsink assembly.
3. Lift the fan duct, then set aside.

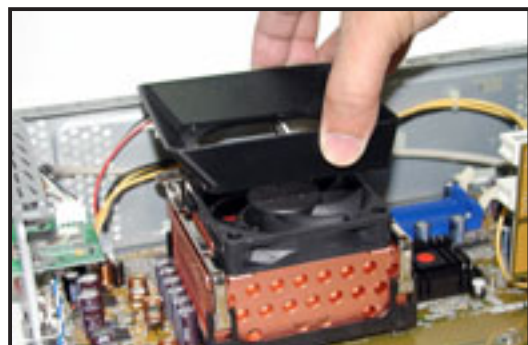
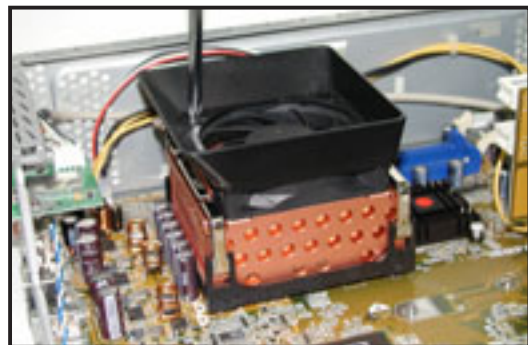
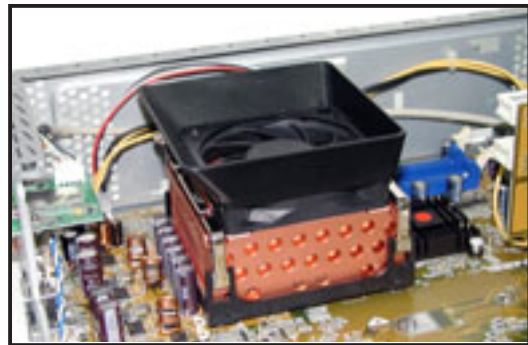



If a memory module is installed to the DIMM socket, remove the module first before removing the CPU fan and heatsink assembly to avoid damaging the DIMM. Refer to page 28 for details on how to remove the memory module(s).

- Carefully press down the locking lever of the retention bracket.

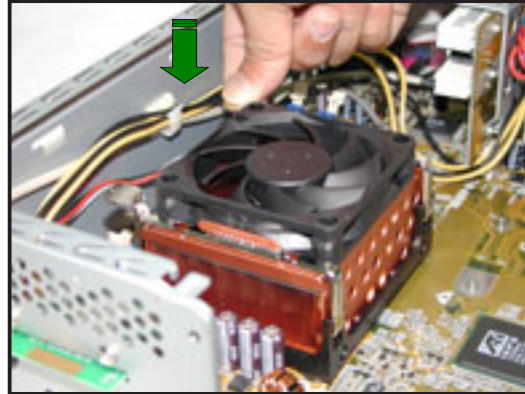

- Detach the retention bracket hook from the retention module hole by flipping the locking lever to the direction of the arrow.

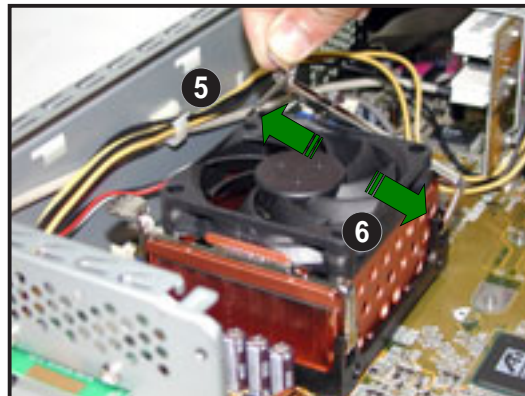

- Detach the other retention bracket hook from the hole on the other side of the retention module.

- Remove the retention bracket, then set aside. Follow the same steps in removing the other retention bracket.



- Disconnect the CPU fan cable from the CPU fan connector on the motherboard.



9. Slightly lift the CPU fan and heatsink assembly, then set aside.

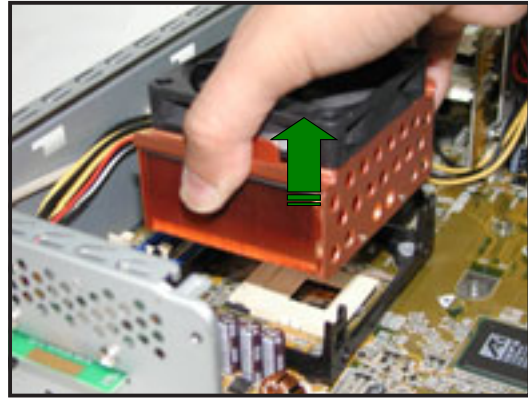

2.5.2 CPU installation

To install the CPU:

1. Locate the 478-pin CPU socket on the motherboard.

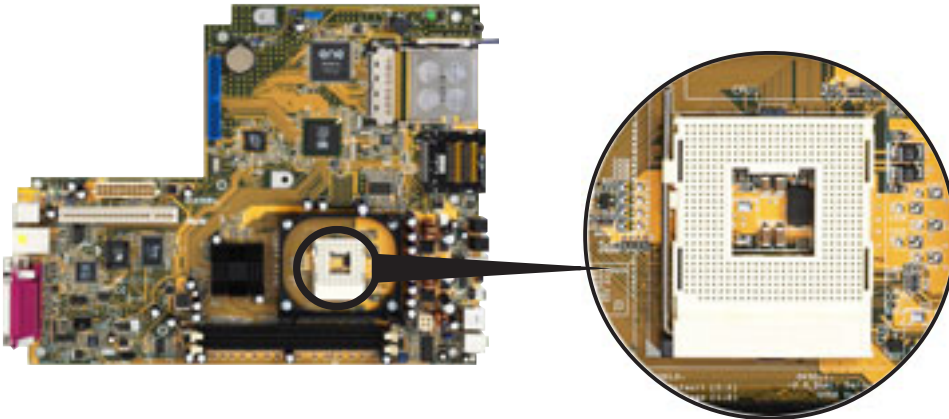

2. Unlock the socket by pressing the lever sideways then lifting it up to a 90° angle.

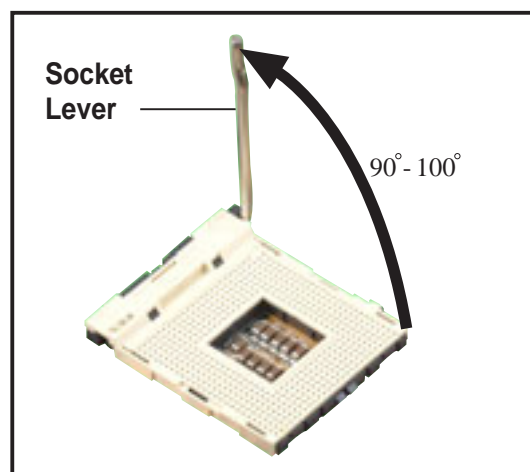

3. Position the CPU above the socket such that its marked corner (gold mark) matches the base of the socket lever.
4. Carefully insert the CPU into the socket until it fits in place.



The CPU fits only in one correct orientation. **DO NOT** force the CPU into the socket to prevent bending the pins and damaging the CPU!

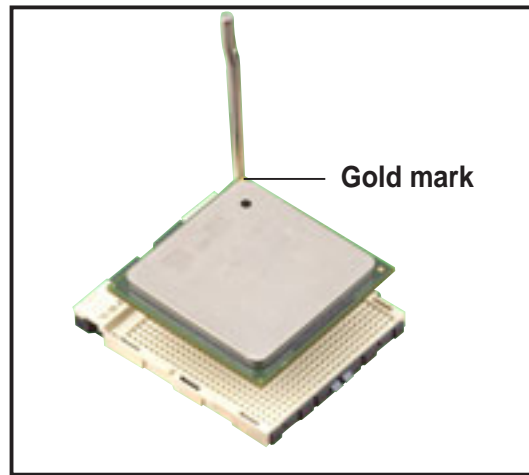

5. Push down the socket lever to secure the CPU. The lever clicks on the side tab to indicate that it is locked.

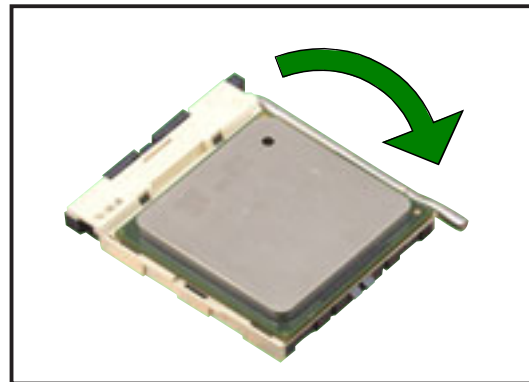

2.5.3 Re-installing the CPU fan and heatsink assembly



Install the CPU fan and heatsink assembly before installing the memory module to avoid damaging the DIMM.

To re-install the CPU fan and heatsink assembly:

1. Position the CPU fan and heatsink assembly on top of the installed CPU.

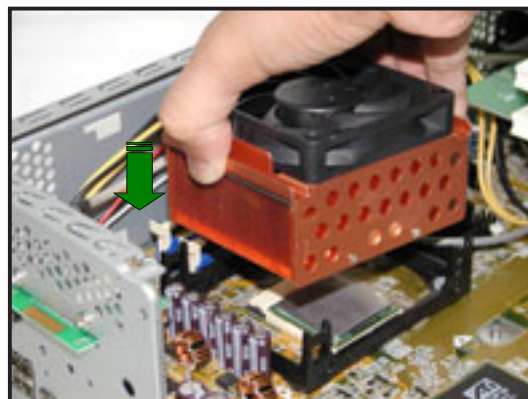

2. Align the retention bracket with the rails on the side of the CPU fan.
3. Attach the retention bracket hook in the retention module hole.

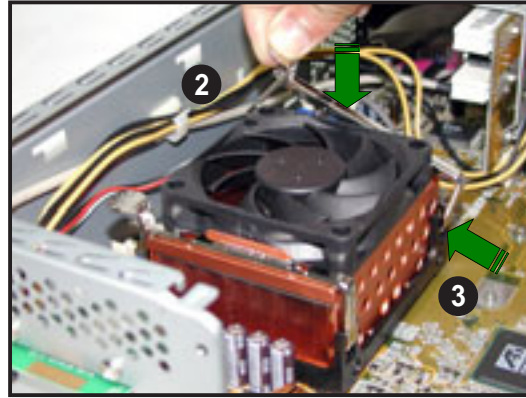

4. Carefully press down the retention bracket locking lever until its hook attaches to the retention module hole.
5. Follow steps 2 to 4 to re-install the second retention bracket.

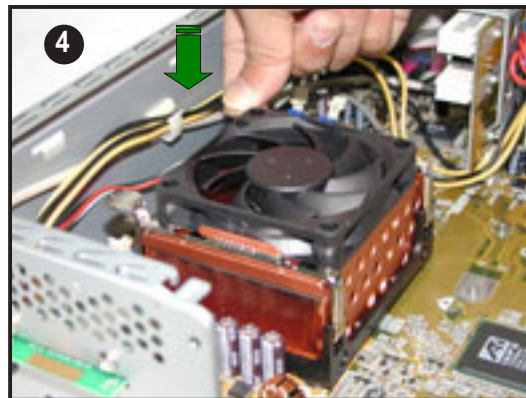

6. Connect the CPU fan cable to the CPU fan connector on the motherboard.



Install the memory module(s) before re-installing the fan duct. Refer to page 27 for details.

7. Position the fan duct on top of the CPU fan.

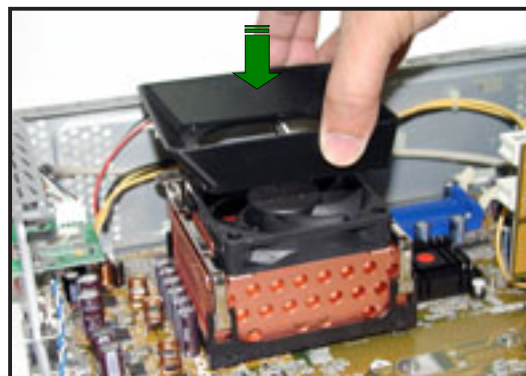

- Secure the fan duct with two screws you earlier removed.

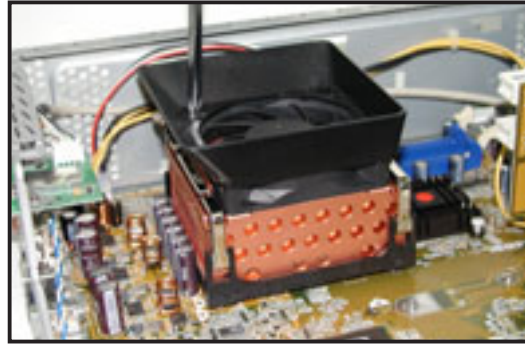

2.6 Installing memory modules

2.6.1 Overview

The system motherboard has two Double Data Rate (DDR) DIMM sockets that support up to 2GB non-ECC PC3200/2700/2100/1600 DDR SDRAM DIMMs. Each DIMM socket is double-sided. Refer to the illustration below for the location of the DIMM sockets.

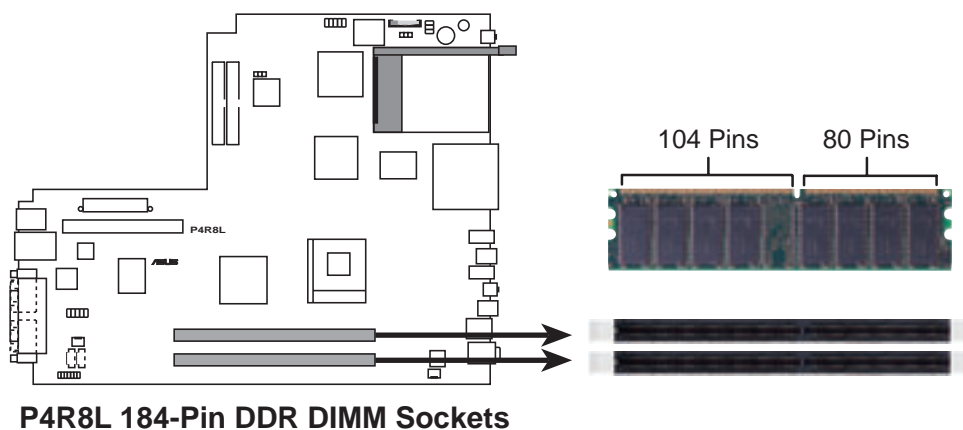

For optimum compatibility, it is recommend that you obtain memory modules from the same vendor. Refer to section 2.6.3 for a list of qualified DDR400 vendors.

2.6.2 Memory configurations

You may install 64MB, 128MB, 256MB, 512MB, and 1GB DDR DIMMs to the DIMM sockets.



This motherboard may only detect PC2700 (DDR333) system memory when you install double-sided PC3200 (DDR400) DIMMs.

2.6.3 Qualified Vendor List

The following table lists the DDR400 memory modules that have been tested and qualified for use with this motherboard.

Size	Vendor	Model	Brand	Component
256MB	NANYA	NT256D64S88V1G-5T	NANYA	200608PT
256MB	KINGSTON	KVR400X64C25/256	WINBOND	W942508BH-5
256MB	TWINMOS	M2G9108AIATT9F018AADT	TWINMOS	TMD7608F8E50D
256MB	INFINEON	22-T003C1127	INFINEON	HYB25D256800BT-5
256MB	ADATA	MD0AD5F3C31YB1EZ2	ADATA	ADD8608A8A-5B
256MB	HYNIX	PC3200U-30330	HYNIX	HYMD232646V8J-D43
256MB	TWINMOS	231M52034480042	WINBOND	W942508BH-5
256MB	SAMSUNG	M368L3223DTM-CC4	SAMSUNG	K4H560838D-TCC4
256MB	PSC	960AL5D8B53TA1-5B	PSC	A2S56D30BTP



Obtain DDR DIMMs only from ASUS qualified vendors. Visit the ASUS website (www.asus.com) for the latest QVL.

2.6.4 Installing a DIMM



- Make sure to unplug the power supply before adding or removing DIMMs or other system components. Failure to do so may cause severe damage to both the motherboard and the components.
- Re-install the CPU fan and heatsink assembly before installing the DIMM(s) to avoid damaging the memory module(s).

Follow these steps to install a DIMM.

1. Locate the DIMM sockets in the motherboard.
2. Unlock a DIMM socket by pressing the retaining clips outward.
3. Align a DIMM on the socket such that the notch on the DIMM matches the break on the socket.

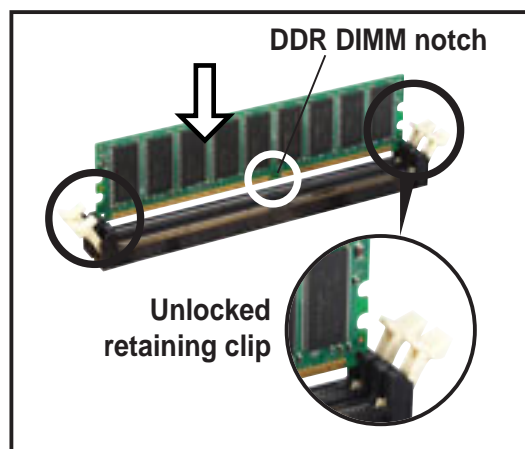

4. Firmly insert the DIMM into the socket until the retaining clips snap back in place and the DIMM is properly seated.



A DDR DIMM is keyed with a notch so that it fits in only one direction. DO NOT force a DIMM into a socket to avoid damaging the DIMM.

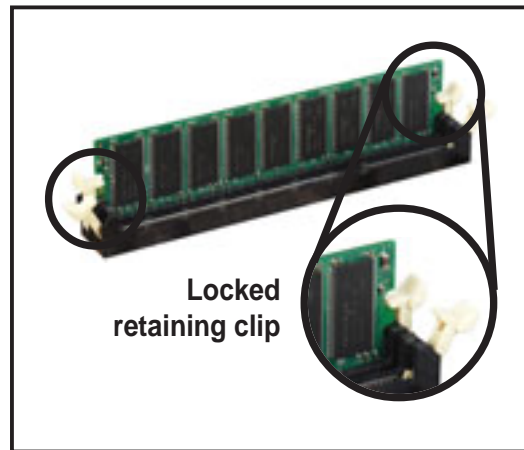

2.6.5 Removing a DIMM

Follow these steps to remove a DIMM.

1. Simultaneously press the retaining clips outward to unlock the DIMM.



Support the DIMM lightly with your fingers when pressing the retaining clips. The DIMM might get damaged when it flips out with extra force.

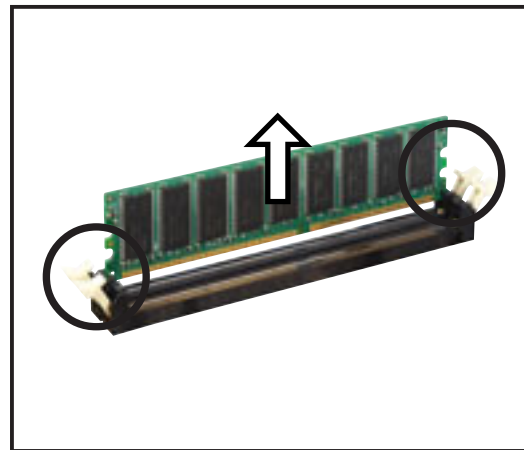

2. Remove the DIMM from the socket.



Remove the memory module before removing the CPU fan and heatsink assembly. Incorrect installation sequence may damage the DIMM(s).

2.7 Installing PCI cards

In the future, you may need to install PCI cards to the system. The system motherboard has one PCI slot with a pre-installed PCI riser assembly that supports two PCI cards.



Make sure to unplug the power cord before adding or removing expansion cards. Failure to do so may cause you physical injury and damage motherboard components.

2.7.1 PCI slots

The PCI slots support PCI cards such as a LAN card, SCSI card, USB card, and other cards that comply with PCI specifications. The following figure shows a LAN card installed on a PCI slot.

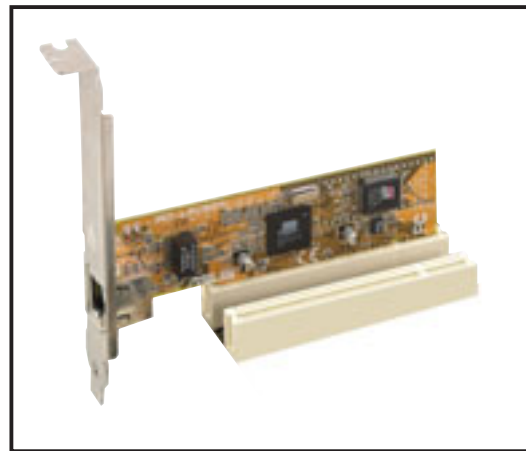

2.7.2 PCI card installation

To install a PCI card:

1. Slightly lift the PCI riser assembly until it disengages from the chassis.

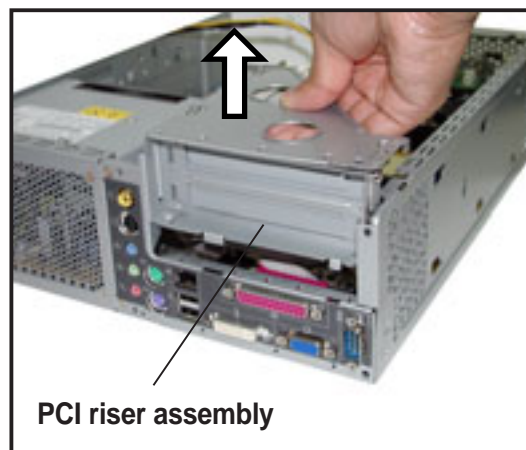

2. Place the PCI riser assembly on a flat surface.

3. Remove the bracket opposite the PCI slot you wish to use. Keep the screw for later use.

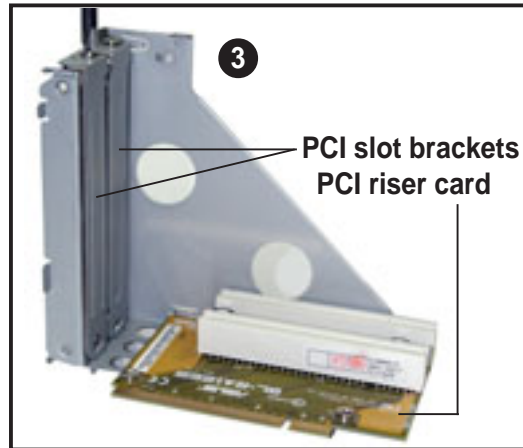

4. Align the PCI card connector with the slot and press firmly until the card is completely seated on the slot.

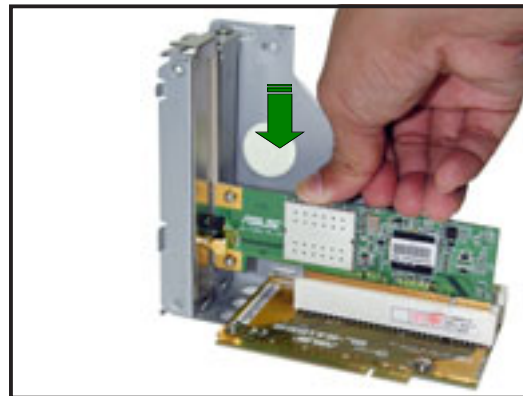

5. Secure the PCI card to the PCI riser assembly with the screw you removed earlier.



6. Re-install the PCI riser assembly to the system chassis.

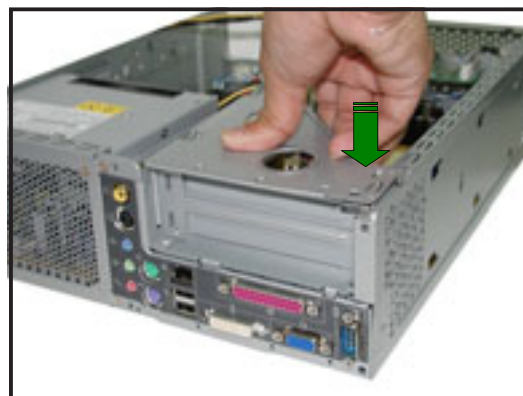

2.7.3 Configuring an expansion card

After installing the expansion card, configure the card by adjusting the software settings.

1. Turn on the system and change the necessary BIOS settings, if any. See Chapter 5 for information on BIOS setup.
2. Assign an IRQ to the card. Refer to the tables on the next page.
3. Install the software drivers for the expansion card.

Standard interrupt assignments

IRQ	Priority	Standard Function
0	1	System Timer
1	2	Keyboard Controller
2	N/A	Programmable Interrupt
3*	11	Communications Port (COM2)
4*	12	Communications Port (COM1)
5*	13	Sound Card (sometimes LPT2)
6	14	Floppy Disk Controller
7*	15	Printer Port (LPT1)
8	3	System CMOS/Real Time Clock
9*	4	ACPI Mode when used
10*	5	IRQ Holder for PCI Steering
11*	6	IRQ Holder for PCI Steering
12*	7	PS/2 Compatible Mouse Port
13	8	Numeric Data Processor
14*	9	Primary IDE Channel
15*	10	Secondary IDE Channel

* These IRQs are usually available for ISA or PCI devices.

IRQ assignments for this motherboard

	A	B	C	D
PCI slot 1	shared	—	—	—
Onboard USB controller HC0	—	—	—	shared
Onboard USB controller HC1	—	—	—	shared
Onboard USB 2.0 controller	—	—	—	shared
Onboard LAN	—	—	shared	—
Onboard Audio	—	used	—	—
Onboard 1394 controller	—	—	shared	—
CardBus controller	shared	—	—	shared



When using a PCI card on shared slots, ensure that the drivers support “Share IRQ” or that the cards do not need IRQ assignments.

Otherwise, conflicts will arise between the two PCI groups, making the system unstable and the card inoperable.

2.8 Installing storage drives

The system supports one UltraATA100/66 IDE or one Serial ATA hard disk drive.

2.8.1 Installing an IDE hard disk drive



Configure your hard disk drive as Master device before installing it in the storage drive assembly. Refer to the HDD documentation on how to set the drive as a Master device.

To install an **IDE** hard disk drive:

1. Lay the storage drive assembly on its top on a flat surface.
2. Insert an IDE hard disk drive to the drive bay upside down.
3. Push the hard disk drive into the bay until their screw holes align.
4. Secure the drive with two screws on both sides of the bay.

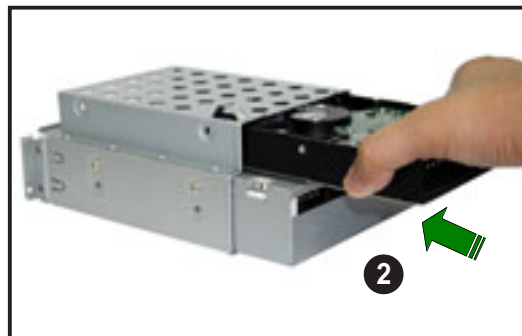

You can re-install the storage drive assembly if you do not intend to install a new optical drive or upgrade a pre-installed one. Refer to the next section on how to install an optical drive.

5. Connect one end of the 40-pin IDE cable to the IDE connector at the back of the drive.
6. Connect the other end of the IDE cable to the PRI_SIDE or PRI_XWIDE connector on the motherboard.

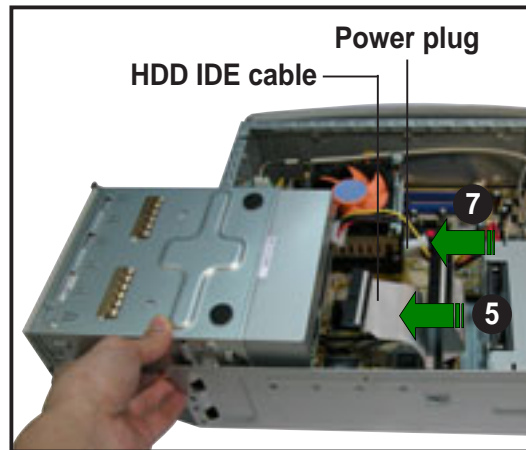

For models with a HDD security feature, connect the other end of the IDE cable to the PRI_XWIDE connector on the motherboard. See page 67 for details.

7. Connect a 4-pin power plug from the power supply unit to the power connector at the back of the drive.
8. Re-install the storage drive assembly, then secure it with the screws you removed earlier.

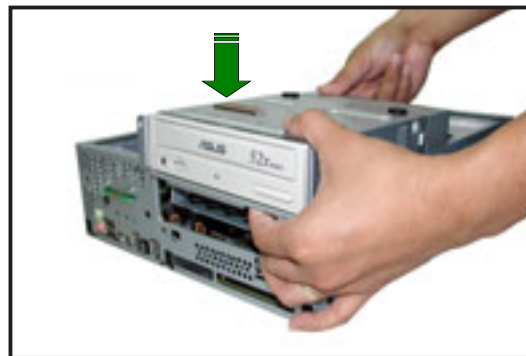

2.8.2 Installing a Serial ATA hard disk drive

To install a **Serial ATA** hard disk drive:

1. Follow steps 1 to 4 of the previous section.

2. Connect one end of the supplied 7-pin SATA cable to the connector at the back of the drive, then connect the other end to the SATA connector on the motherboard. See page 68 for the location of the Serial ATA connector.



3. *For Serial ATA HDDs **with** a 4-pin power connector:*

Connect a 4-pin (female) power plug from the power supply unit (PSU) to the 4-pin (male) power connector at the back of the drive.

*For Serial ATA HDDs **without** a 4-pin power connector:*

Use the supplied SATA power cable. Connect a 4-pin plug (female) from the PSU to the 4-pin (male) plug of the SATA power cable. Connect the 15-pin SATA power plug to the power connector at the back of the drive.

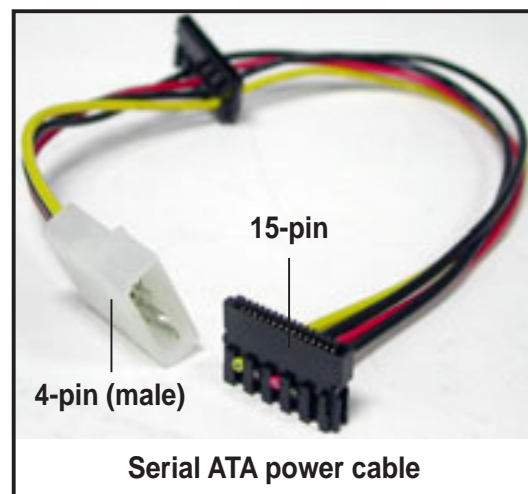

2.8.3 Installing an optical drive

Recommended optical drive dimension

You must consider the following optical drive requirements when installing a new optical drive or replacing a defective one.



We recommended that you install and use an ASUS optical drive on this system.

Optical drive buttons

The stop/eject button area of the DVD/CD-ROM drive should be less than or equal to 21.9 millimeters from the right edge of the drive.



Optical drive tray

The optical drive tray door should not exceed 4.5 millimeters from the bottom edge of the drive tray. The height of the bottom edge of the drive tray should be less than or equal to 13 millimeters in parallel with the lower drive screw holes.

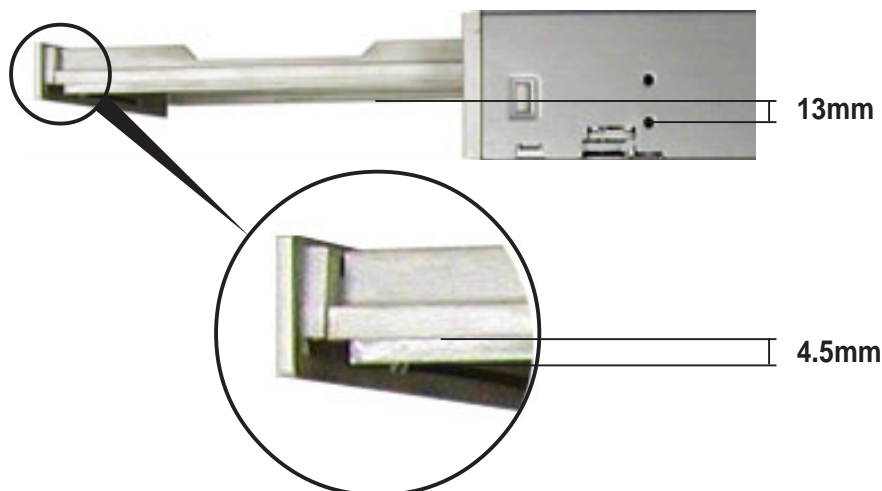

Optical drive cover thickness and length

The thickness of the optical drive front panel cover should be less than or equal to 7 millimeters and the length of the drive should be less than or equal to 208 millimeters.

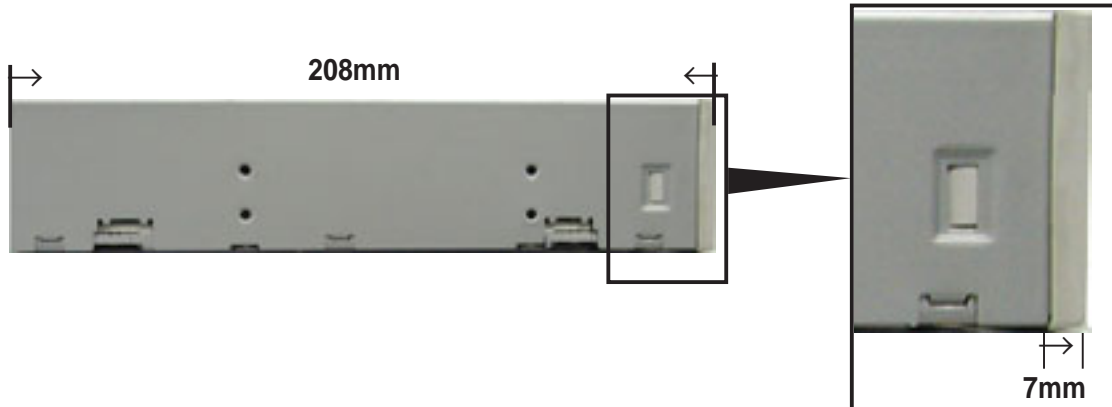

Installing a new optical drive

To install a new optical drive:

1. Lay the storage drive assembly upside down on a flat surface.
2. Insert the optical drive to the bay upside down.

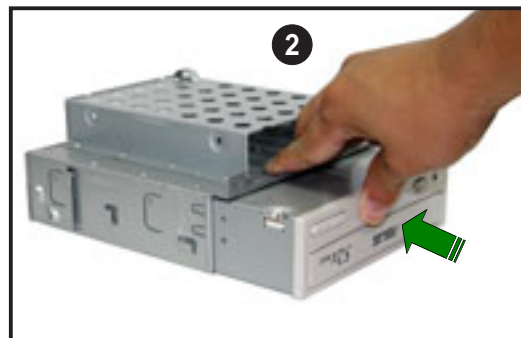

3. Push the drive into the bay until their screw holes align.

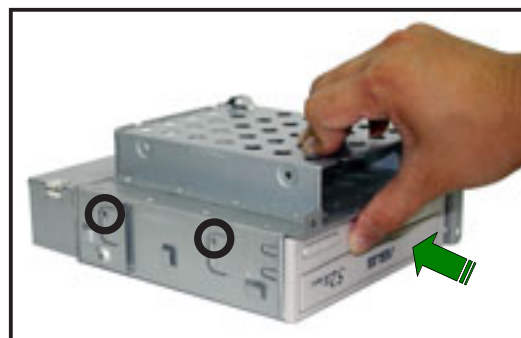

4. Secure the optical drive with two screws on both sides of the bay.



5. Connect a 4-pin (female) power plug from the power supply unit to the power connector at the back of the optical drive.

6. Connect one end of the IDE ribbon cable to the IDE connector at the back of the drive. Match the red stripe on the cable with Pin 1 on the IDE connector.

7. Connect one end of the audio cable to the 4-pin connector at the back of the drive.

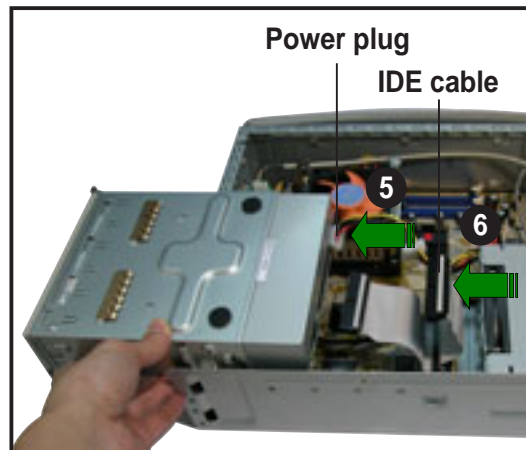

8. Connect the other end of the IDE cable to the PRI_SIDE connector on the motherboard. See page 67 for the location of the PRI_SIDE connector.

9. Connect the other end of the audio cable to the 4-pin CD connector on the motherboard. See page 69 for the location of the CD connector.

10. Re-install the storage drive assembly, then secure it with the screws you earlier removed.

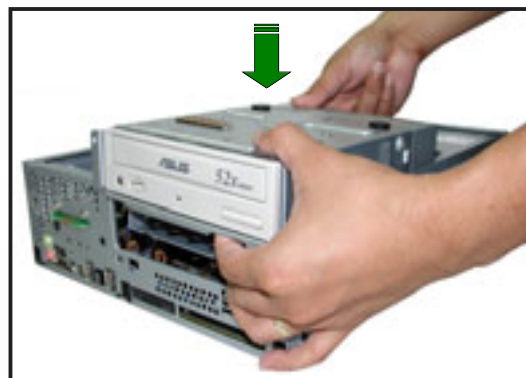

Replacing or upgrading a pre-installed optical drive

In the future, you may need to replace a defective optical drive or upgrade an installed one:

1. Make sure the optical drive you intend to install complies with the recommended dimensions mentioned in page 35 to 36.
2. Lay the storage drive assembly on its top on a flat surface.
3. Remove four screws that secure the optical drive to the bay. Keep the screws for later use.



4. Push the old optical drive out from the bay, then set aside.
5. Follow steps 2 to 10 of the previous section to install a new optical drive.



2.9 Replacing the cover

After installing all system components and re-connecting all cables, replace the system cover by following these instructions.



1. Replace the front panel cover by fastening its hooks to the chassis holes until they fit in place.

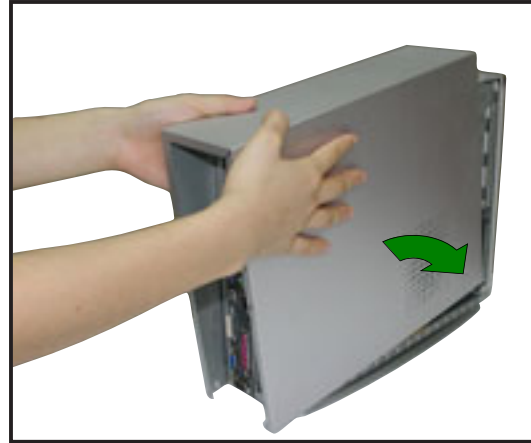

2. Position the cover at least two inches from the front panel, then align the cover hooks to the chassis rail.

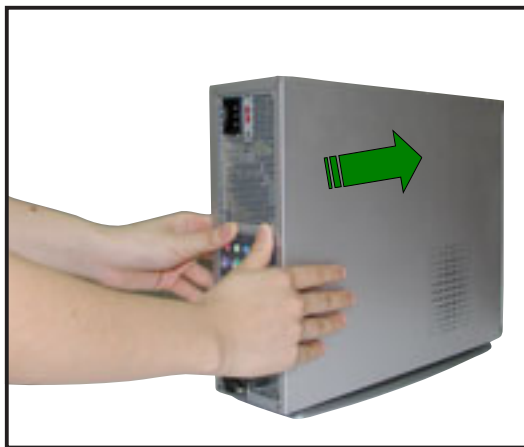

3. Push the system cover toward the front panel until it fits in place.

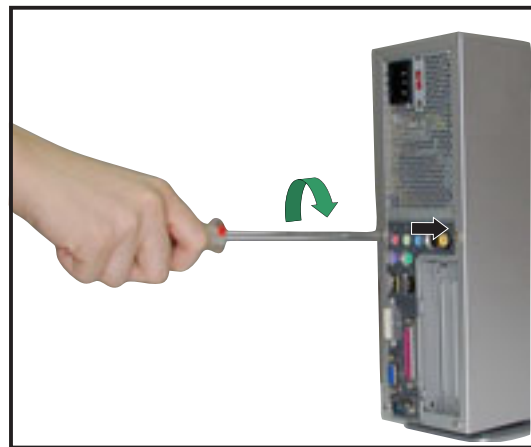

4. Secure the system cover with the screws you removed earlier.

2.10 Removing and re-installing the foot stand

The system comes with a removable foot stand for vertical desktop placement. Follow the instructions to remove or re-install the foot stand.

2.10.1 Removing the foot stand

To remove the foot stand:

1. Lay the system upside down on a flat and stable surface.
2. Locate the foot stand lock.

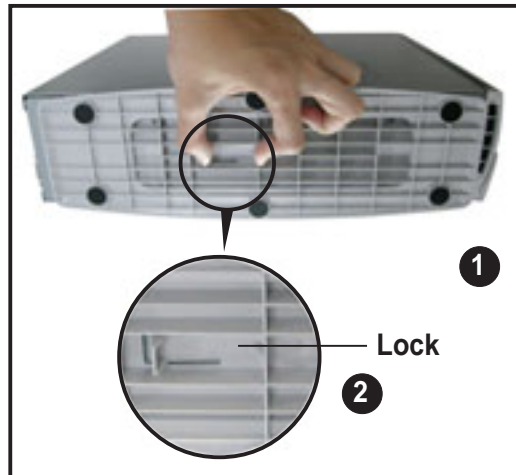

3. Use your thumb to push the lock toward the rear panel until the foot stand tabs are released from the chassis holes.
4. Lift the foot stand, then set it aside.

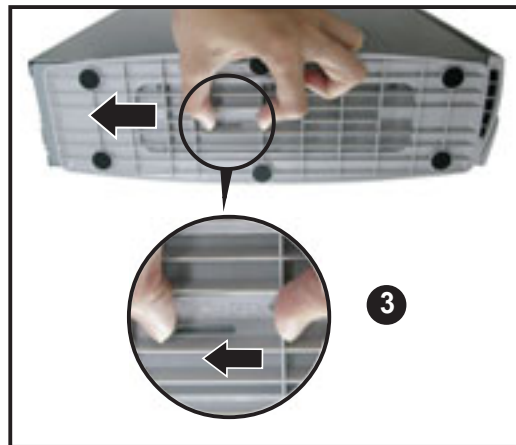

2.10.2 Re-installing the foot stand

To re-install the foot stand:

1. Locate six tab holes on the bottom of the chassis.

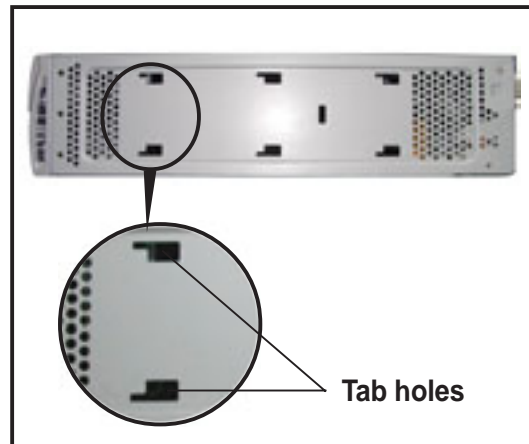

2. Align the foot stand hooks to the chassis holes, then lay the foot stand over the chassis bottom.

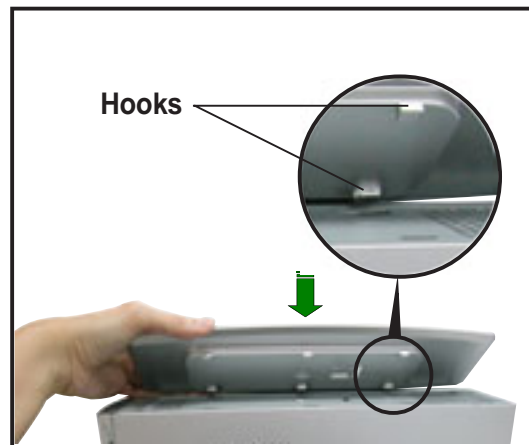

3. Pull the foot stand toward the front panel until it fits in place.

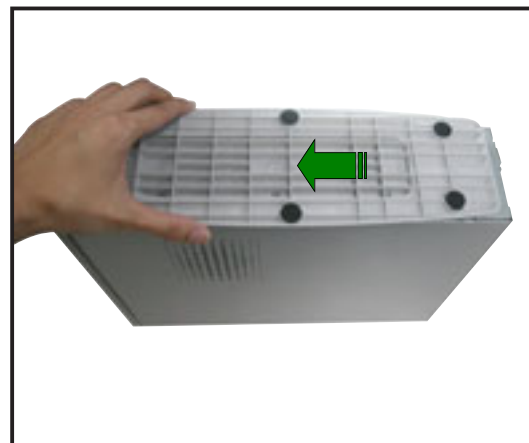

2.11 Power supply unit information

The system comes with a 200W power supply unit (PSU).

2.11.1 Voltage selector

The PSU has a 115V/230V voltage selector switch located beside the power socket. Use this switch to select the appropriate voltage according to the voltage supply in your area.



The voltage selector is set to 230V by default.

If the voltage supply in your area is 100-127V, set the switch to 115V.

If the voltage supply in your area is 200-240V, set the switch to 230V.

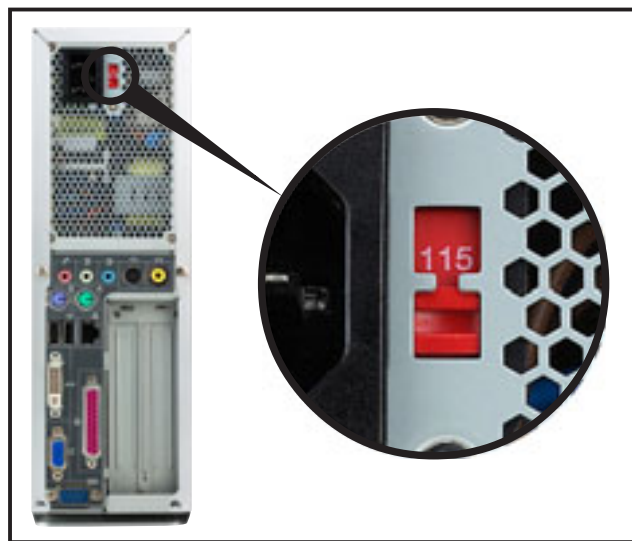

Setting the switch to 115V in a 230V environment will seriously damage the system!

2.11.2 Power supply specifications

Input Characteristics

Input Voltage Range	Min	Nom	Max
Range 1	90V	115V	135V
Range 2	180V	230V	265V
Input Frequency Range	47 Hz to 63 Hz		
Maximum Input ac Current	4A max. at 115Vac 2A max. at 230Vac, maximum load		
Inrush Current	90A max. at 115Vac, full load cold start at 25°C		
Efficiency	70% min. at nominal input, maximum load		

Output Characteristics

Output Voltage	Load Range		Regulation		Ripple
	Min	Max	Min	Max	Max
+5V	0.5A	4.0A	-5%	+5%	50mV _{p-p}
+12V	0.45A	9.5A	-5%	+5%	120mV _{p-p}
-12V	0A	0.2A	-10%	+10%	120mV _{p-p}
+5VSB	0.05A	1.5A	-5%	+5%	50mV _{p-p}
+3V3	1A	8.0A	-5%	+5%	50mV _{p-p}

Over-Voltage Protection (OVP)

Output Voltage	Maximum Voltage
+5V	6.5V
+12V	15.6V
+3.3V	4.3V



The power supply will shut down and latch off for shorting +5V, +12V, -12V, or +3.3V. By shorting +5VSB, the power supply can latch down or automatically recover when the fault condition is removed

2.12 Connecting devices

To the rear panel



To the front panel

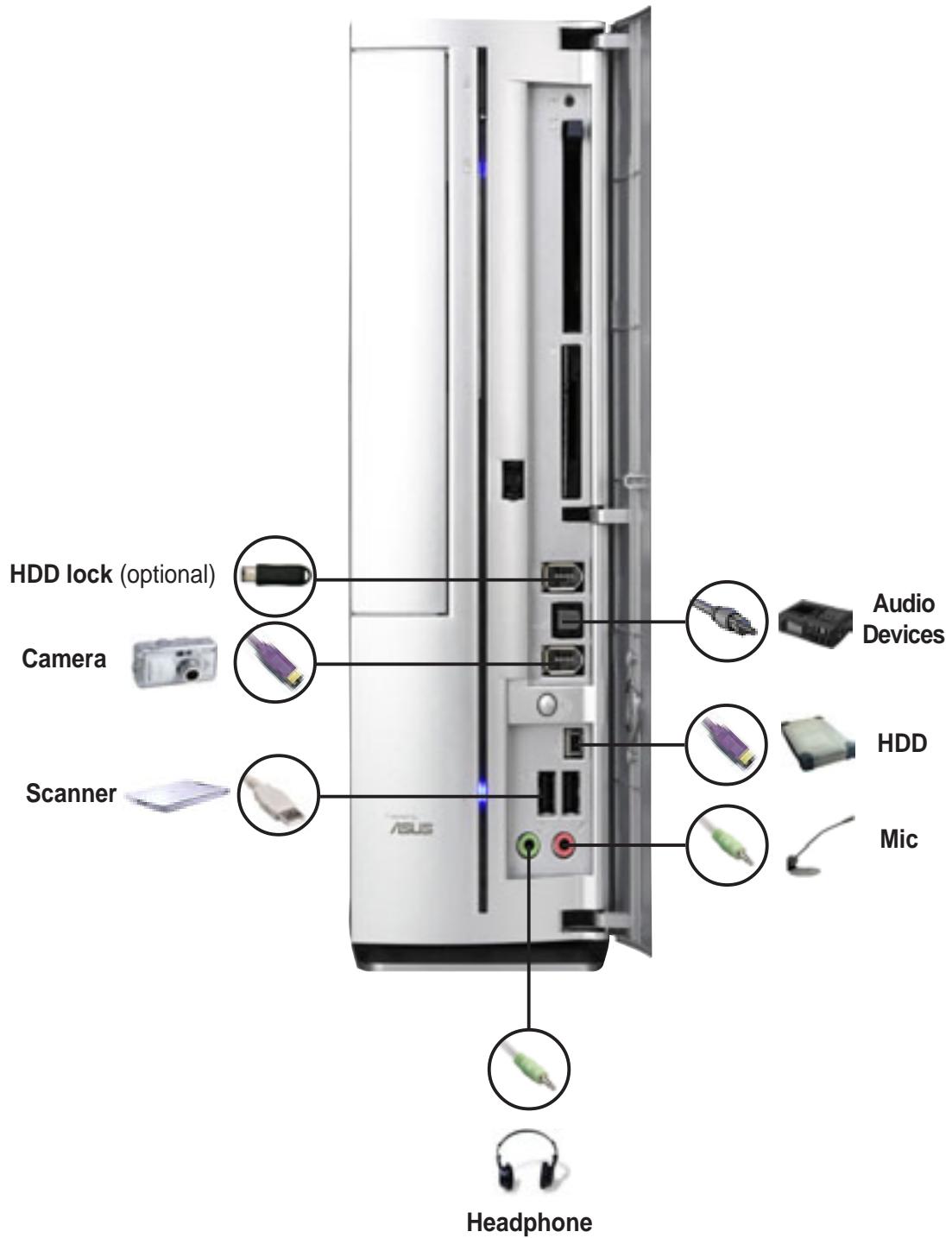

Chapter 3

This chapter tells you how to turn on the system and install the drivers and utilities from the support CD. This chapter also describes the software applications that the system supports.



ASUS AB-P2800 book size barebone system

Starting up

3.1 Installing an operating system

The ASUS book size barebone system supports Windows® 2000/XP operating systems (OS). Always install the latest OS version and corresponding updates so you can maximize the features of your book size barebone system.



Because motherboard settings and hardware options vary, use the setup procedures presented in this chapter for general reference only. Refer to your OS documentation for detailed information.

Hard disk drive security port (optional)

The system features a hard disk drive security port that allows you to lock the hard disk drive and prevent unauthorized access to your hard disk drive data. Using the supplied security keys, you may lock the HDD following the instructions in this section.



-
- Two security keys are included in the system package if your system comes with a security port.
 - Refer to page 13 for the location of the security port.
-

Using the security port and keys

To use the security port and keys:

1. Enable the XWALL jumper on the system motherboard following the instructions on page 64.
2. Insert the security key to the security port.
3. Turn on the system.
4. Format or reformat the hard disk drive following the documentation that comes with the drive, then install an operating system. Make sure the HDD you intend to secure is connected to the PRI_XWIDE connector.
5. Restart your computer.



Do not lose the security keys! You need to reformat the hard disk drive and lose all your data when you lose the security keys. It is recommended that you back up all your HDD data when you lose one of the keys.

3.2 Powering up

The system has two power buttons located in the front panel. Press the system power button (⏻) to enter the OS.

System power button



3.3 Using the system

The following sections illustrate how to use the PCMCIA and storage card reader slots, and the optical drive.

3.3.1 PCMCIA card slot

The system comes with a PCMCIA (Personal Computer Memory Card International Association) card slot that supports Type I/II PCMCIA cards. The illustration shows how to insert a PCMCIA card.



3.3.2 Storage card slot

A 4-in-1 storage card reader comes pre-installed in your ASUS book size barebone system. The storage card reader supports the following storage cards:

- **SmartMedia**
- **Memory Stick®**
- **Secure Digital™**
- **MultimediaCard**

The illustration shows how to insert a storage card to the storage card reader.



3.3.3 Optical drive

If your system comes with an installed optical drive, follow these instructions to insert a CD/DVD to the drive.

1. Press the EJECT button of the optical drive.
2. Place a CD/DVD on the drive tray. Make sure the CD/DVD is properly seated on the tray locks.
3. Push the drive tray back to the drive.



Tray locks

3.4 Support CD information

The support CD that came with the system contains useful software and several utility drivers that enhance the system features.



- Screen display and driver options may not be the same for other operating system versions.
- The contents of the support CD are subject to change at any time without notice. Visit the ASUS website for updates.

3.4.1 Running the support CD

To begin using the support CD, place the CD in your optical drive. The CD automatically displays the **Drivers** menu if Autorun is enabled in your computer.

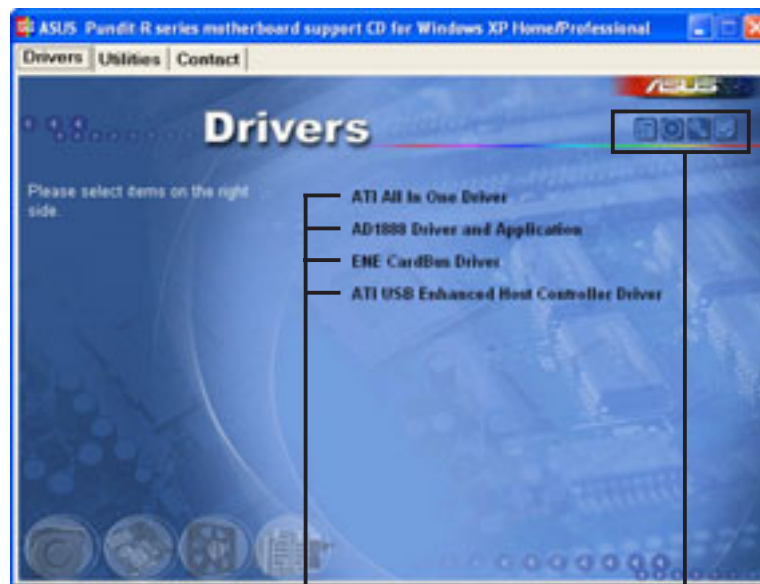

Click an item to install

Click an icon to display other information



If **Autorun** is NOT enabled in your computer, browse the contents of the support CD to locate the file **ASSETUP.EXE** from the BIN folder. Double-click the **ASSETUP.EXE** to run the CD.

3.4.2 Drivers menu

The drivers menu shows the available device drivers if the system detects installed devices. Install the necessary drivers to activate the devices.

ATI All In One Driver

Click this item to install the ATI All In One Driver for the P4R8L motherboard.

AD1888 Driver and Application

This item installs the AD1888 audio driver and SoundMax® application. See page 57 for details.

EME CardBus Driver

Click this item to install the driver for the PCMCIA card slot.

ATI USB Enhanced Controller Driver

This item installs the driver for the onboard USB 2.0 ports.



You do not need to install the USB enhanced controller driver if you are using Windows® XP (SP1).

3.4.3 Utilities

The **Utilities** tab displays the applications and softwares that the motherboard supports.



ASUS PC Probe

This utility continuously monitors vital system information such as fan rotations, CPU temperature, and system voltages, and alerts you on any detected problems. This utility helps you keep your computer in a healthy operating condition.

Install ASUS Update VX.XX.XX

This item installs the ASUS Update that allows you to update the motherboard BIOS and drivers. This utility requires an Internet connection either through a network or an Internet Service Provider (ISP). See page 75 for details.

PC-CILLIN 2002

This item installs the PC-cillin 2002 anti-virus program. View the PC-cillin online help for detailed information.

ADOBE Acrobat Reader V5.0

This item installs the Adobe® Acrobat Reader®. The Acrobat® Acrobat Reader® software is for viewing files saved in Portable Document Format (PDF).

ASUS Screensaver

This item installs the ASUS Screensaver.

3.4.4 ASUS contact information

Click the **Contact** tab to display the ASUS contact information.



3.5 ATI IGP Catalyst™

The ATI IGP Catalyst™ allows easy configuration of your display settings. The ATI IGP Catalyst™ icon is displayed in the Windows® taskbar after you installed the **ATI All In One** drivers. Right or left-click the icon to display a menu.



3.5.1 Left-click menu

The left-click menu allows you to select the bits per pixel (BPP) and resolution of your current display.

To change the BPP and resolution settings of your display:

1. Select a BPP and resolution from the menu. A **Change Display Settings** window appears.

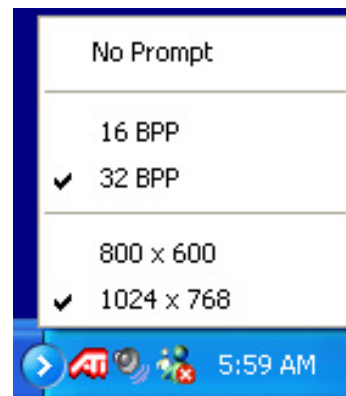

The left-click menu displays only the BPP and resolution supported by your display.

2. Select the **Refresh Rate**, then click **Apply**.

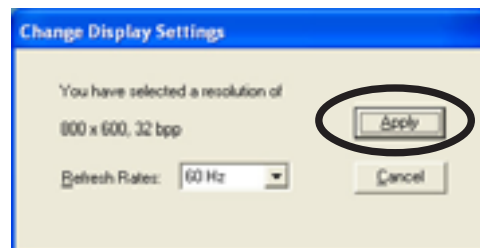

3.5.2 Right-click menu

The ATI IGP Catalyst™ right-click menu provides options for configuring your display settings.

Rotations - This option allows you to rotate the screen of your display(s) clockwise or counterclockwise.

Schemes - The Schemes option allows you to use a single display or switch among available displays.

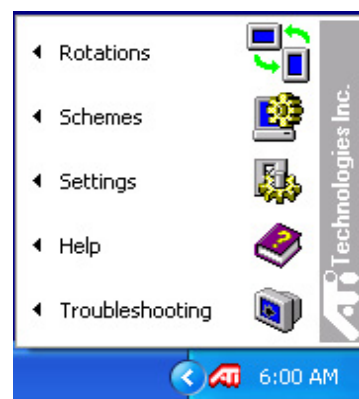

Settings - This option lets you configure the ATI IGP Catalyst™, advanced display settings, and device settings. This menu also allows you to restore the default display settings.

Help - Select this option to view the help menu for the ATI desktop or television display.

Troubleshooting - Select this option to view a troubleshooting guide for the ATI desktop or television display.

3.5.3 Managing multiple displays

This motherboard allows you to use multiple displays via the ATI RADEON™ integrated graphics controller.

To manage multiple displays:

1. Connect a TV or flat panel display using the DVI, S-Video or composite ports. Turn on the TV or flat panel display.

2. Right-click an area in your desktop to display a pop-up menu. Select **Properties**.

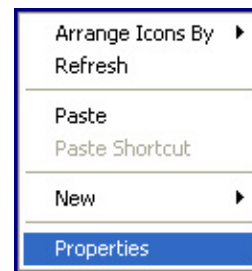

3. A **Display Properties** window appears.

4. Click the **Settings** tab, then the **Advanced** button to display the **ATI RADEON 9100 IGP Properties** window.



4. Click the **Display** tab. Click the **Scheme** drop-down menu, then select **Switch amongst display**. Assign a **Hotkey** to use in switching between displays. Click **Save** when done.
5. Click a display to view, then adjust its properties, if desired.
6. Click **Apply** to save your changes.



Only S-Video signal is available when S-Video and composite video ports are used at the same time. The quality of S-Video is better than composite video.

3.6 Multi-channel audio feature

The AD1888 AC '97 audio CODEC provides 6-channel audio capability. Install the **AD1888 Driver and Application** from the support CD to activate the 6-channel audio feature.



You must use 4-channel or 6-channel speakers for this setup.

Setting to multi-channel audio

After installing the audio driver, follow these instructions to adjust the audio settings and avail the onboard 6-channel audio feature.

1. From the taskbar, double-click the **SoundMAX Digital Integrated Audio** icon to display the **SoundMAX Control Panel**.



2. The **Listening Environment** tab allows you to set to multi-channel speakers, enable or disable the **Virtual Theater Surround**, and select **Acoustic Environments** and **Virtual Ear**.

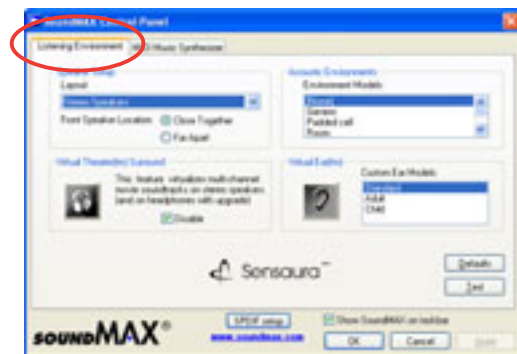

3. The default setting is **Stereo Speakers** (2-channel). To set to a 6-channel speaker system, click the arrow under **Speaker Setup** to display a list of options.
4. Select the option **Surround Sound Speakers (5.1 Surround)**.
5. Click the **Apply** button.

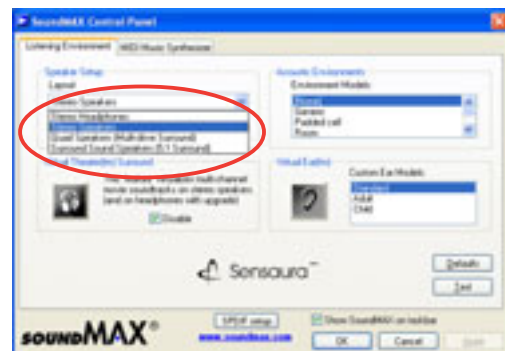

6. Click the **Test** button to display the **Test Listening Environment** window.
7. Select the audio test path from the drop-down menu.



8. After selecting an option, test your setting by clicking the **Play Test Noise** button. While testing, you will see a black circle moving on the screen indicating the audio path.

The **Play Test Noise** button becomes **Stop Playing** button. Click this button at any time to stop playing.

Audio path indicator



9. Click the **Close** button when done.
10. The **MIDI Music Synthesizer** tab allows you to select a setting for the MIDI.



11. Click the **Synthesizer Default Set** drop-down menu to display a list of options. Choose the desired setting.
12. Click **Apply**, then click **OK** when finished.
13. Reboot the computer.



Adjusting the volume settings

1. After rebooting the system, click on the volume control icon on the Windows® taskbar to display the **Volume Control** window.

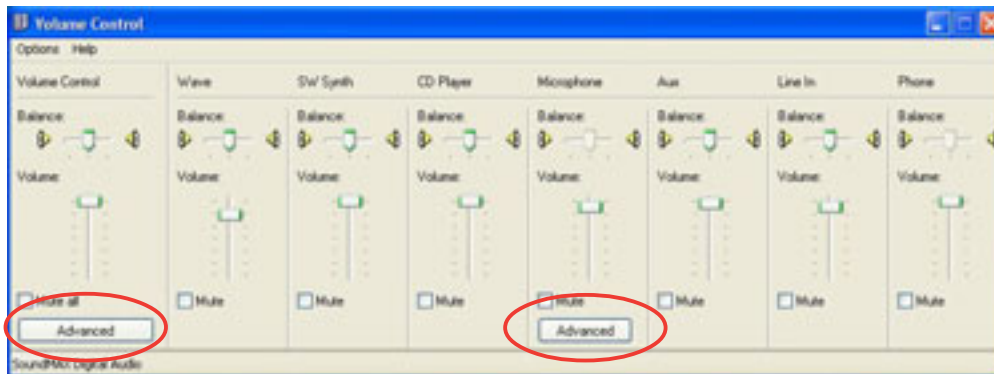

2. Click the Volume Control **Advanced** button. The **Advanced Controls for Volume Control** window appears.

To achieve 6-channel audio capability when playing DVDs, check the boxes opposite **AC3 SPDIF** and **PCM SPDIF**.

Click **Close**.

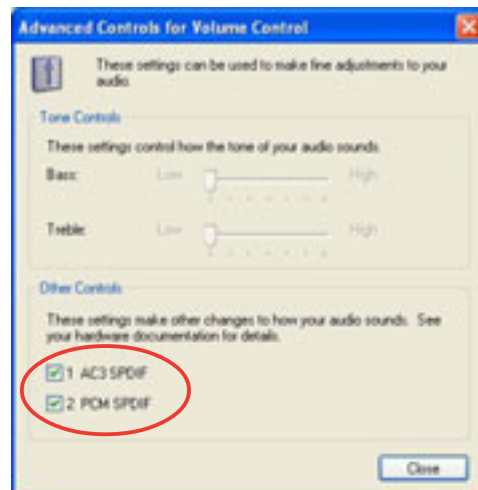

Adjusting the microphone settings

1. Click on the Microphone **Advanced** button to display the **Advanced Controls for Microphone** window.
2. Check the box opposite **Mic2 Select** to enable the front panel microphone.
3. Click **Close** for the new settings to take effect.

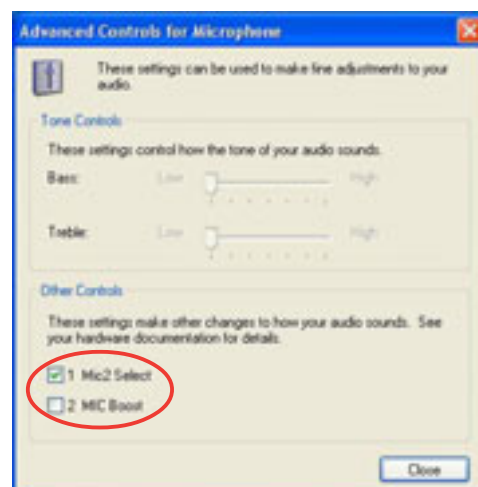

The rear panel Mic port (pink) is automatically disabled when you enable the front panel Mic port. Only one Mic port works at a time.

Chapter 4

This chapter provides information on the pre-installed system motherboard. This chapter includes the motherboard layout, jumper settings, and connector locations.



ASUS AB-P2800 book size barebone system

Motherboard info

4.1 Introduction

The ASUS P4R8L motherboard comes already installed in the ASUS book size barebone system. This chapter provides technical information about the motherboard for future upgrades or system reconfiguration.

4.2 Motherboard layout

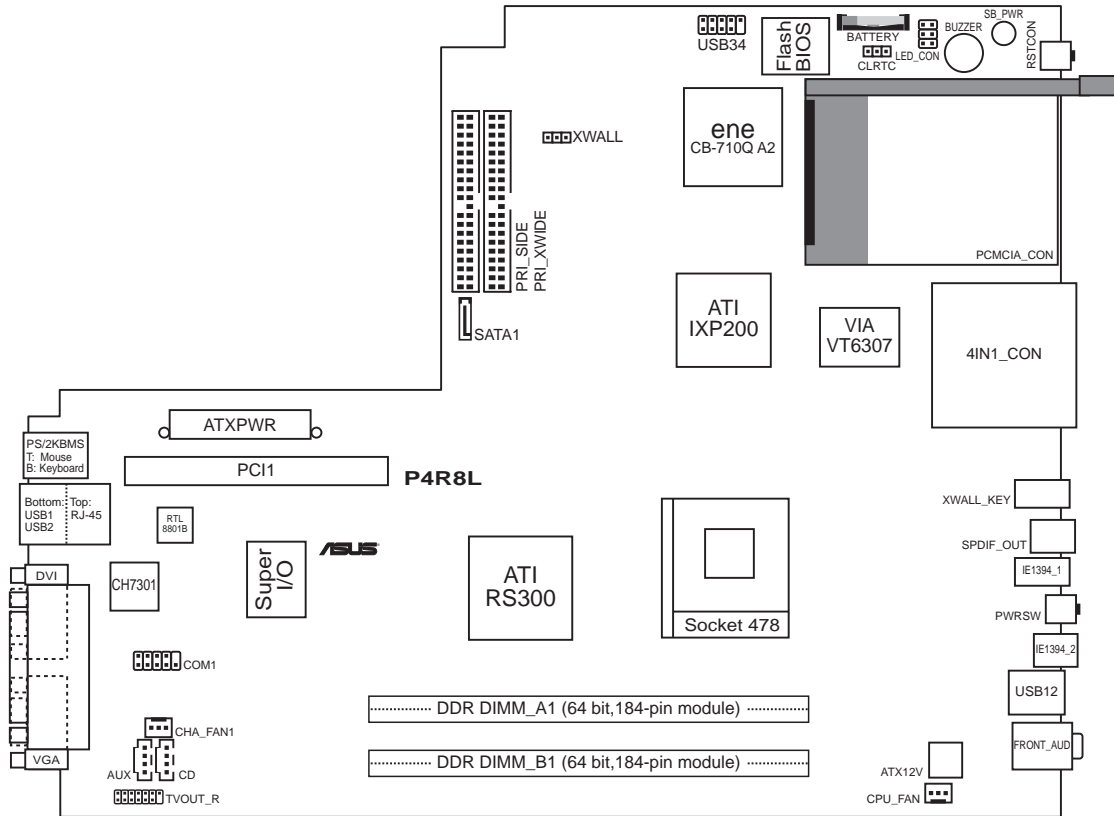

4.3 Jumper

1. Clear RTC RAM (CLRRTC)

This jumper allows you to clear the Real Time Clock (RTC) RAM in CMOS. You can clear the CMOS memory of date, time, and system setup parameters by erasing the CMOS RTC RAM data. The RAM data in CMOS, that include system setup information such as system passwords, is powered by the onboard button cell battery.

To erase the RTC RAM:

1. Turn OFF the computer and unplug the power cord.
2. Remove the battery.
3. Move the jumper cap from pins 1-2 (default) to pins 2-3. Keep the cap on pins 2-3 for about 5-10 seconds, then move the cap back to pins 1-2.
4. Re-install the battery.
5. Plug the power cord and turn ON the computer.
6. Hold down the key during the boot process and enter BIOS setup to re-enter data.

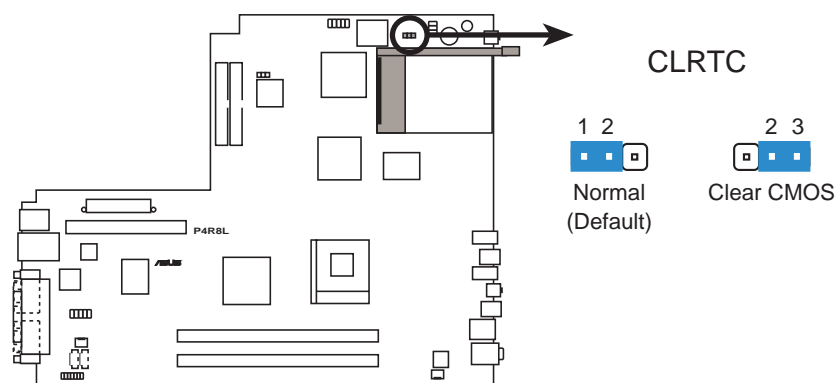

P4R8L Clear RTC RAM



Except when clearing the RTC RAM, never remove the cap on CLRRTC jumper default position. Removing the cap will cause system boot failure.

2. Hard disk drive lock jumper (optional 3-pin XWALL)

This jumper allows you to enable or disable the hard disk drive security feature for the HDD connected to the PRI_XWIDE connector. Put the jumper cap to pins 1~2 to enable hard disk drive security.



See page 48 for details on the HDD security feature. The hard disk drive lock jumper is available only on models with a hard disk drive security feature.

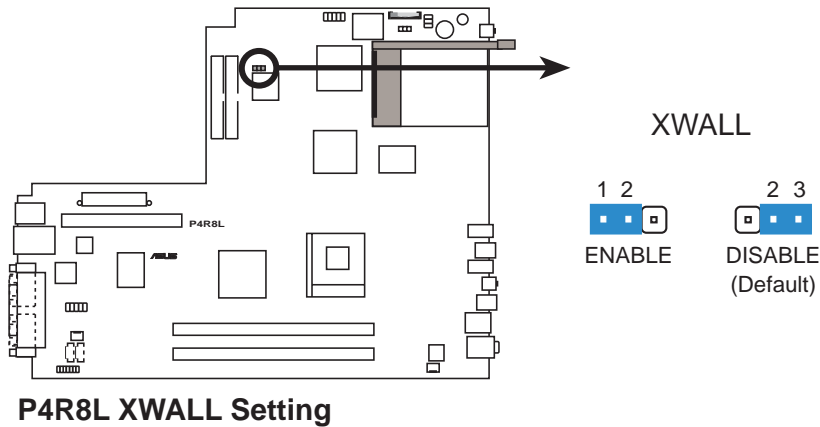

The XWALL jumper enables hard disk drive security only for the IDE hard disk drive connected to the PRI_XWIDE connector.

4.4 Internal connectors

This section describes and illustrates the connectors on the motherboard. See page 14-15 for the description of the rear panel connectors.

1. USB connector (10-1 pin USB34)

If the rear panel USB 2.0 ports are inadequate, a USB header is available at midboard to accommodate two additional USB ports. You may connect the cable of a two-port USB module to this connector, then mount the module to an open slot in the chassis.

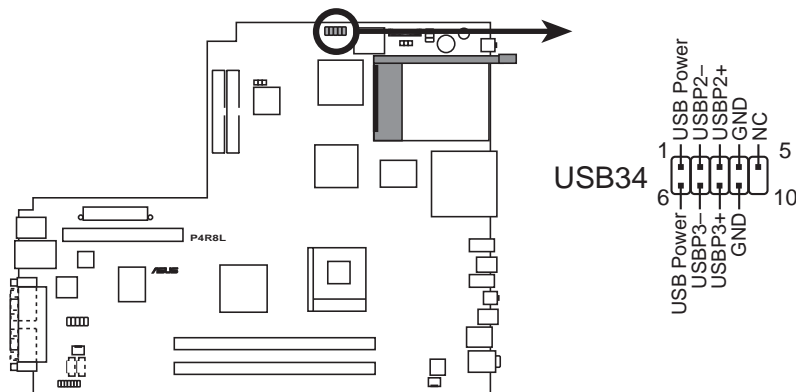

P4R8L USB Port

2. Rear panel TV and audio ports connector (14-1 pin TVOUT_R)

This interface is connected to the ASUS proprietary daughtercard that supports the rear panel audio I/O, S-Video, and composite video ports.

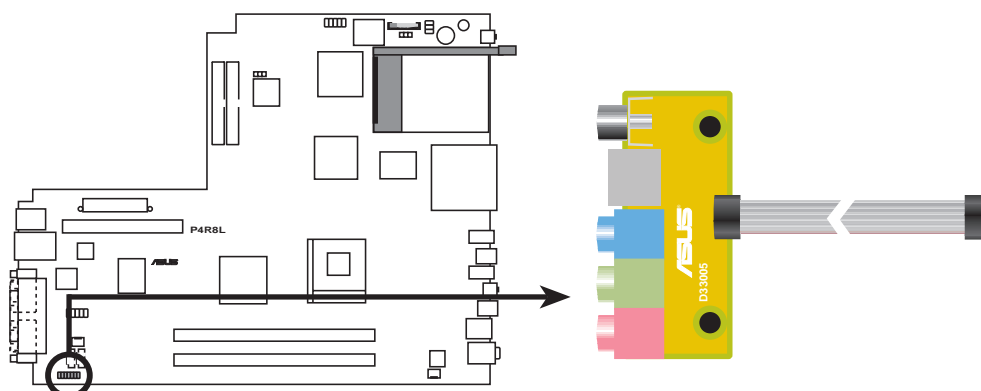

P4R8L Rear Panel TV and Audio Ports Connector

3. LED connector (6-pin LED_CON1)

This connector supports the Power and HDD activity LEDs in the system front panel.

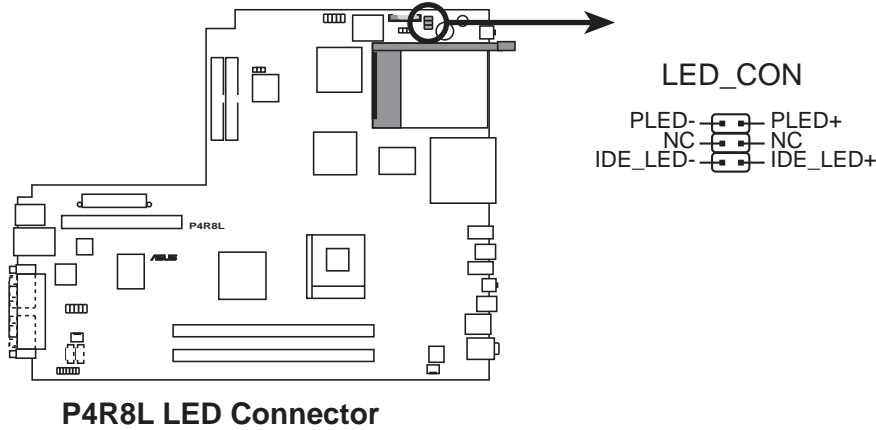

4. ATX power connectors (20-pin ATXPWR, 4-pin ATX12V)

These connectors are for the 20-pin and 4-pin power plugs from the power supply unit. The plugs from the power supply unit are designed to fit these connectors in only one orientation. Find the proper orientation and push down firmly until the connectors completely fit.

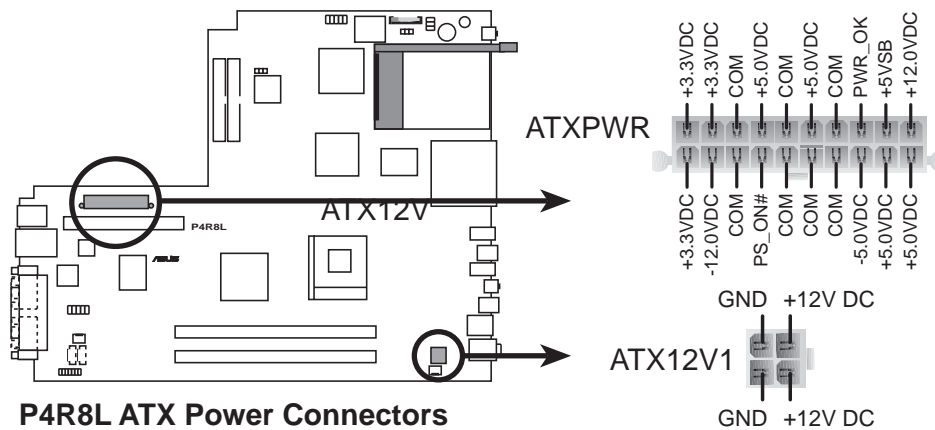

5. IDE connectors (40-1 pin PRI_SIDE, PRI_XWIDE)

The PRI_XWIDE connector is for the primary master device (hard disk drive) with the security feature. Attach the blue connector of the 40-pin cable to this interface, then attach the black connector to the UltraATA100/66 primary master device (hard disk drive). The PRI_SIDE connector is for the secondary master device (optical drive). Configure the hard disk drive and the optical drive as primary/secondary master device by adjusting their jumper settings. Refer to their respective documentation for details.



Pin 20 on the IDE connector is removed to match the covered hole on the UltraATA cable connector. This prevents incorrect orientation when you connect the cables.

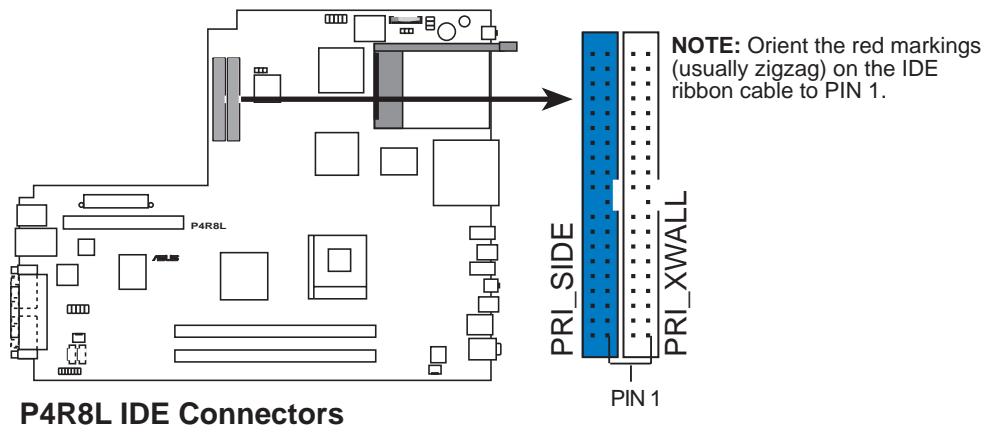

See page 48 for details on the HDD security feature.

6. Serial ATA connectors (7-pin SATA1)

This next generation connector supports the thin Serial ATA cable for a Serial ATA hard disk drive. The current Serial ATA interface allows up to 150 MB/s data transfer rate, faster than the standard parallel ATA with 133 MB/s (UltraATA133).

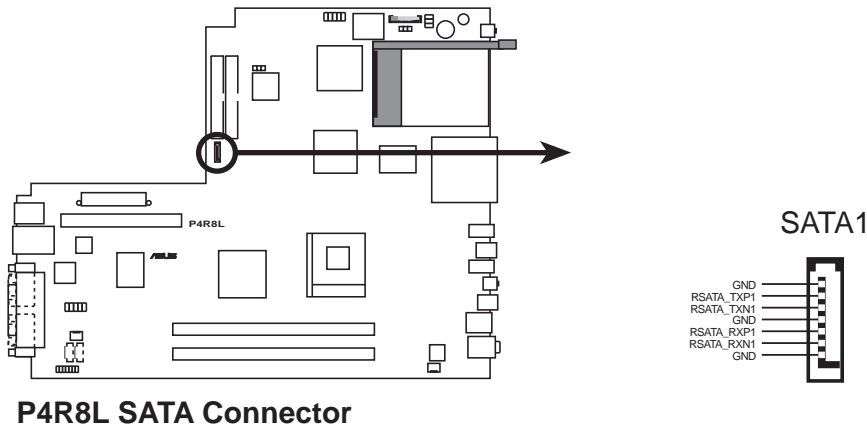

P4R8L SATA Connector

Important notes on Serial ATA



- The Serial ATA cable is smaller and more flexible allowing easier routing inside the chassis. The lower pin count of the Serial ATA cable eliminates the problem caused by the wide, flat ribbon cables of the Parallel ATA interface.
- Hot plug support for Serial ATA drive and connections are not available in this motherboard.
- Install Windows® XP™ Service Pack 1 when using Serial ATA.

7. Serial port connector (10-1 pin COM1)

This connector supports the rear panel serial port.

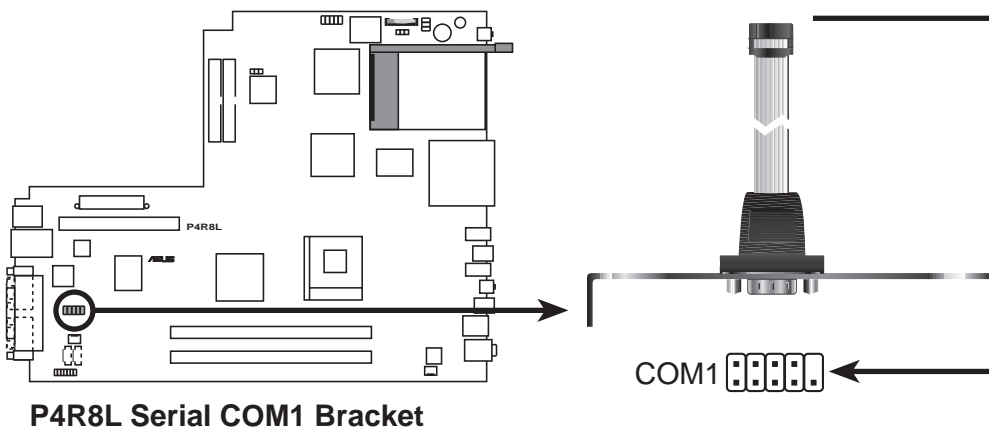

P4R8L Serial COM1 Bracket

8. Internal audio connectors (4-pin AUX, CD)

These connectors allow you to receive stereo audio input from sound sources such as a optical drive, TV tuner, or MPEG card.

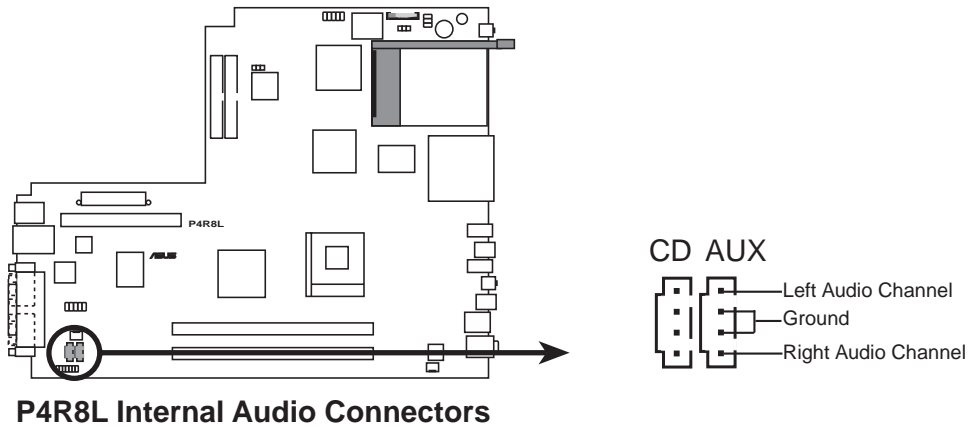

9. CPU and chassis fan connectors (3-pin CPU_FAN, CHA_FAN)

The fan connectors support the proprietary CPU fan and chassis fan. Connect the fan cable to the connector matching the black wire to the ground pin.

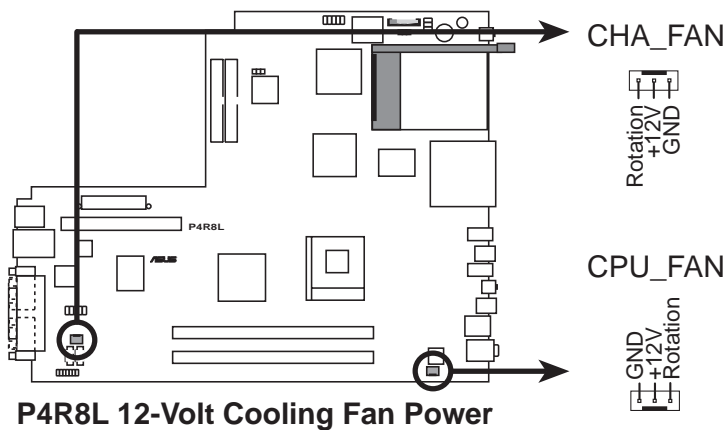

Do not forget to connect the fan cables to the fan connectors. Lack of sufficient air flow within the system may damage the motherboard components. These are not jumpers! DO NOT place jumper caps on the fan connectors!

Chapter 5

This chapter tells how to change system settings through the BIOS Setup menus and describes the BIOS parameters.



ASUS AB-P2800 book size barebone system

BIOS setup

5.1 Managing and updating your BIOS

The following utilities allow you to manage and update the motherboard Basic Input/Output System (BIOS) setup.

1. **CrashFree BIOS 2** (*Updates the BIOS using the support CD when the BIOS gets corrupted.*)
2. **ASUS Update** (*Updates the BIOS in Windows® environment.*)

Refer to the corresponding section for each utility.

Important notes



-
- It is recommended that you save a copy of the **original motherboard BIOS file** to a **USB flash disk** in case you need to restore the BIOS in the future. Copy the original motherboard BIOS using the ASUS Update utility.
 - A **working BIOS file** for this motherboard is in the support CD. Use this file only when you do not have a copy of the original motherboard BIOS file in a USB flash disk or floppy disk.
 - Visit the ASUS website and download the latest BIOS file for this motherboard using the ASUS Update utility.
-

5.1.1 Recovering the BIOS with CrashFree BIOS 2

The CrashFree BIOS 2 auto recovery tool allows you to restore BIOS from the motherboard support CD, or from a USB floppy disk or flash disk that contains the BIOS file, in case the current BIOS on the motherboard fails or gets corrupted.



-
- Prepare the **support CD** that came with the motherboard that contains the motherboard BIOS (P4R8L.ROM) before proceeding with the BIOS update process.
 - If you have saved a copy of the original motherboard BIOS to a bootable USB floppy disk or USB flash disk, you may also use this disk to restore the BIOS.
-

To recover the BIOS from the support CD:



Make sure the optical drive is set as secondary master device when recovering the BIOS using the support CD.

1. Boot the system.
2. When a corrupted BIOS is detected, the following screen message appears.

```
Bad BIOS checksum. Starting BIOS recovery...
Checking for floppy...
```



The system automatically checks the optical drive.

3. Place the support CD in the optical drive. The support CD contains the original BIOS for this motherboard.

```
Bad BIOS checksum. Starting BIOS recovery...
Checking for floppy...
Floppy not found!
Checking for CD-ROM...
CD-ROM found.
Reading file "p4r81.rom". Completed.
Start flashing...
```



DO NOT shutdown or reset the system while updating the BIOS! Doing so may cause system boot failure!

4. When the BIOS update process is complete, reboot the system.



The recovered BIOS may not be the latest BIOS version for this motherboard. Visit the ASUS website (www.asus.com) to download the latest BIOS file.

5.1.2 ASUS Update

The ASUS Update is a utility that allows you to update the motherboard BIOS in Windows® environment. This utility is available in the support CD that comes with the motherboard package. ASUS Update requires an Internet connection either through a network or an Internet Service Provider (ISP).

To install ASUS Update:

1. Place the support CD in the optical drive. The **Drivers** menu appears.
2. Click the **Utilities** tab, then click **Install ASUS Update VX.XX.XX**. See page 52 for the **Utilities** screen menu.
3. The ASUS Update utility is copied into your system.

To update the BIOS using the ASUS Update:

1. Launch the utility from the Windows desktop by clicking **Start > Programs > ASUS > ASUSUpdate > ASUSUpdate**. The ASUS Update initial screen appears.
2. Select your desired update method, then click **Next**.

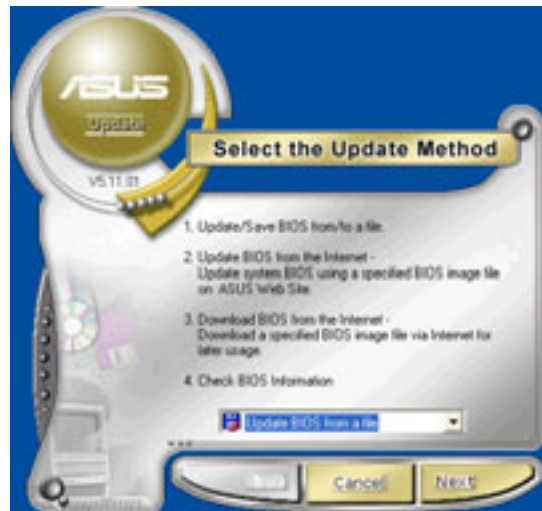

3. If you selected updating/downloading from the Internet, select the ASUS FTP site nearest you to avoid network traffic, or choose **Auto Select**. Click **Next**.



4. From the FTP site, select the BIOS version that you wish to download. Click **Next**.
5. Follow the instructions on the succeeding screens to complete the update process.

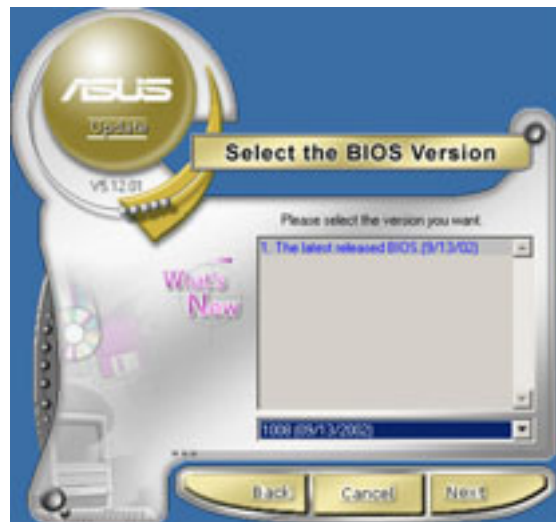

If you selected the option to update the BIOS from a file, a window pops up prompting you to locate the file. Select the file, click **Save**, then follow the screen instructions to complete the update process.

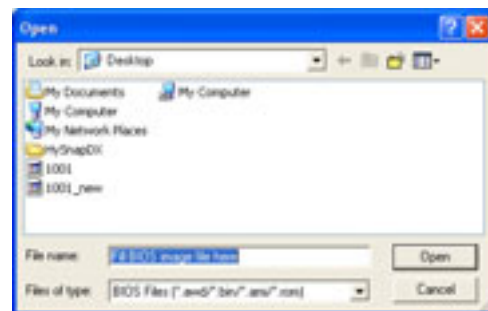

5.2 BIOS Setup program

This motherboard supports a programmable Firmware Hub (FWH) that you can update using the provided utility described in section 5.1 “Managing and updating your BIOS.”

Use the BIOS Setup program when you are installing a motherboard, reconfiguring your system, or prompted to “Run Setup”. This section explains how to configure your system using this utility.

Even if you are not prompted to use the Setup program, you may want to change the configuration of your computer in the future. For example, you may want to enable the security password feature or make changes to the power management settings. This requires you to reconfigure your system using the BIOS Setup program so that the computer can recognize these changes and record them in the CMOS RAM of the firmware hub.

The firmware hub stores the Setup utility. When you start up the computer, the system provides you with the opportunity to run this program. Press <Delete> during the Power-On Self Test (POST) to enter the Setup utility, otherwise, POST continues with its test routines.

If you wish to enter Setup after POST, restart the system by pressing <Ctrl> + <Alt> + <Delete>, or by pressing the reset button on the system chassis. You can also restart by turning the system off and then back on. Do this last option only if the first two failed.

The Setup program is designed to make it as easy to use as possible. It is a menu-driven program, which means you can scroll through the various sub-menus and make your selections among the predetermined choices.



Because the BIOS software is constantly being updated, the following BIOS setup screens and descriptions are for reference purposes only, and may not exactly match what you see on your screen.

5.2.1 BIOS menu screen

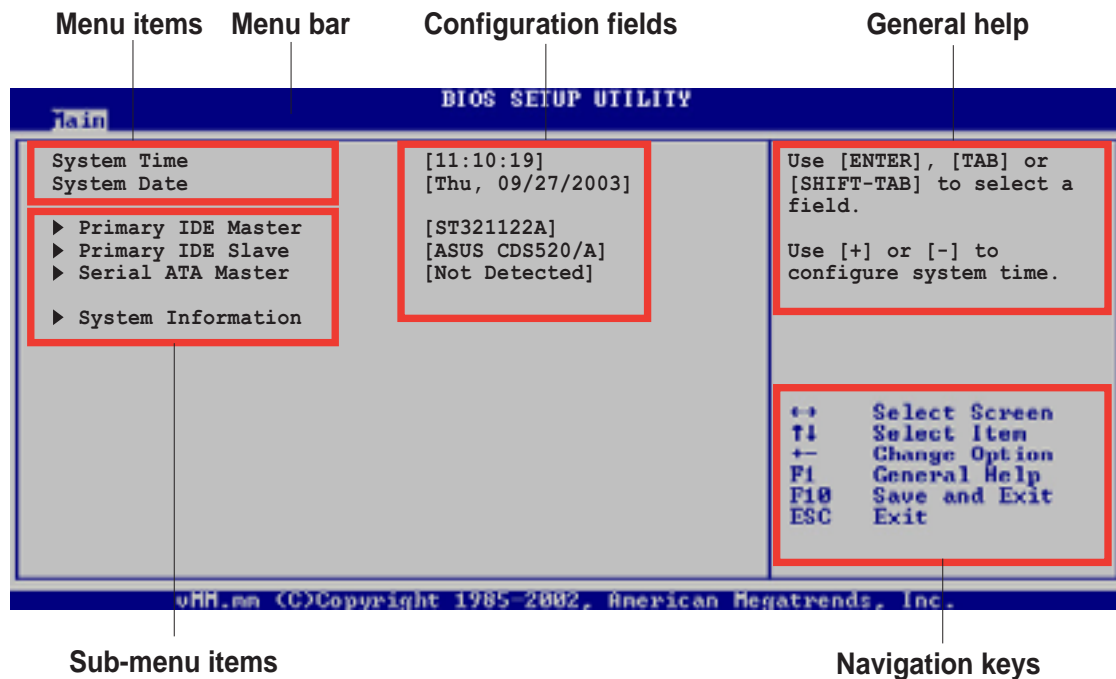

5.2.2 Menu bar

The menu bar on top of the screen has the following main items:

- Main** For changing the basic system configuration
- Advanced** For changing the advanced system settings
- Power** For changing the advanced power management (APM) configuration
- Boot** For changing the system boot configuration
- Exit** For selecting the exit options and loading default settings

To select an item on the menu bar, press the right or left arrow key on the keyboard until the desired item is highlighted.

5.2.3 Navigation keys

At the **bottom right corner** of a menu screen are the navigation keys for that particular menu. Use the navigation keys to select items in the menu and change the settings.



Some of the navigation keys differ from one screen to another.

5.2.4 Menu items

The highlighted item on the menu bar displays the specific items for that menu. For example, selecting **Main** shows the Main menu items.

The other items (Advanced, Power, Boot, and Exit) on the menu bar have their respective menu items.

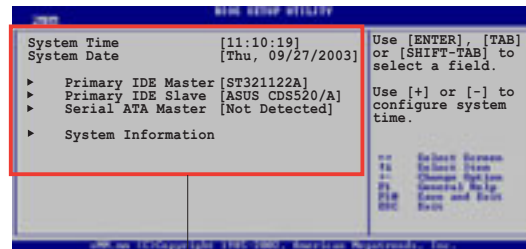

Main menu items

5.2.5 Sub-menu items

An item with a sub-menu on any menu screen is distinguished by a solid triangle before the item. To display the sub-menu, select the item and press <Enter>.

5.2.6 Configuration fields

These fields show the values for the menu items. If an item is user-configurable, you may change the value of the field opposite the item. You can not select an item that is not user-configurable.

A configurable field is enclosed in brackets, and is highlighted when selected. To change the value of a field, select it then press <Enter> to display a list of options. Refer to “5.2.7 Pop-up window.”

5.2.7 Pop-up window

Select a menu item then press Enter to display a pop-up window with the configuration options for that item.

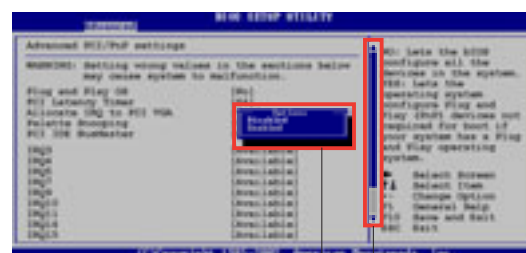

Pop-up window

Scroll bar

5.2.8 Scroll bar

A scroll bar appears on the right side of a menu screen when there are items that do not fit on the screen. Press **Up/Down arrow keys** or **PageUp/PageDown keys** to display the other items on the screen.

5.2.9 General help

At the top right corner of the menu screen is a brief description of the selected item.

5.3 Main menu

When you enter the BIOS Setup program, the Main menu screen appears giving you an overview of the basic system information.



Refer to section 5.2.1 BIOS menu screen” for information on the menu screen items and how to navigate through them.

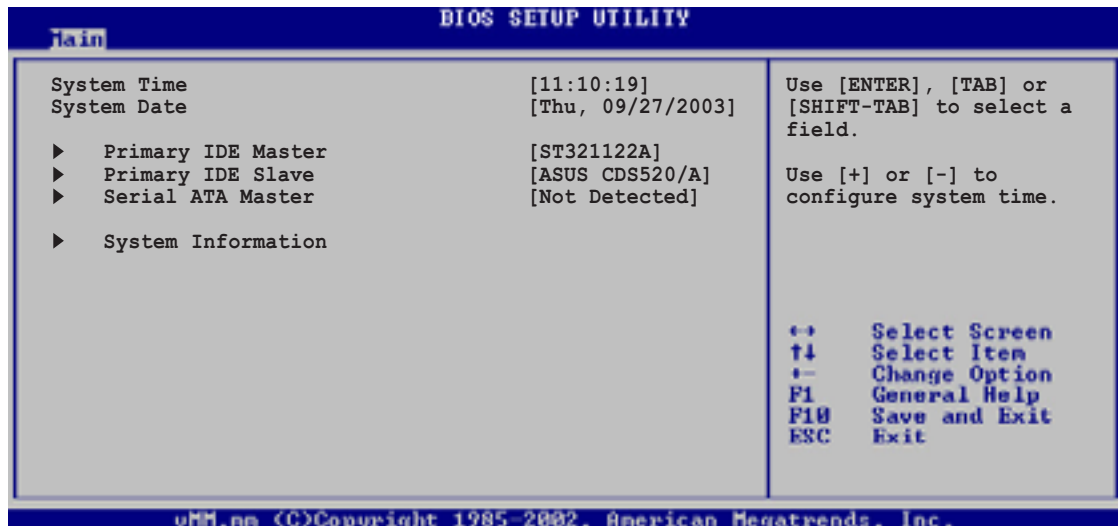

5.3.1 System Time [xx:xx:xxxx]

This item allows you to set the system time.

5.3.2 System Date [Day xx/xx/xxxx]

This item allows you to set the system date.

5.3.3 Primary IDE Master/Slave; Serial ATA Master

While entering Setup, BIOS auto-detects the presence of IDE/Serial ATA devices. There is a separate sub-menu for each IDE/Serial ATA device. Select a device item then press Enter to display the IDE/Serial ATA device information.

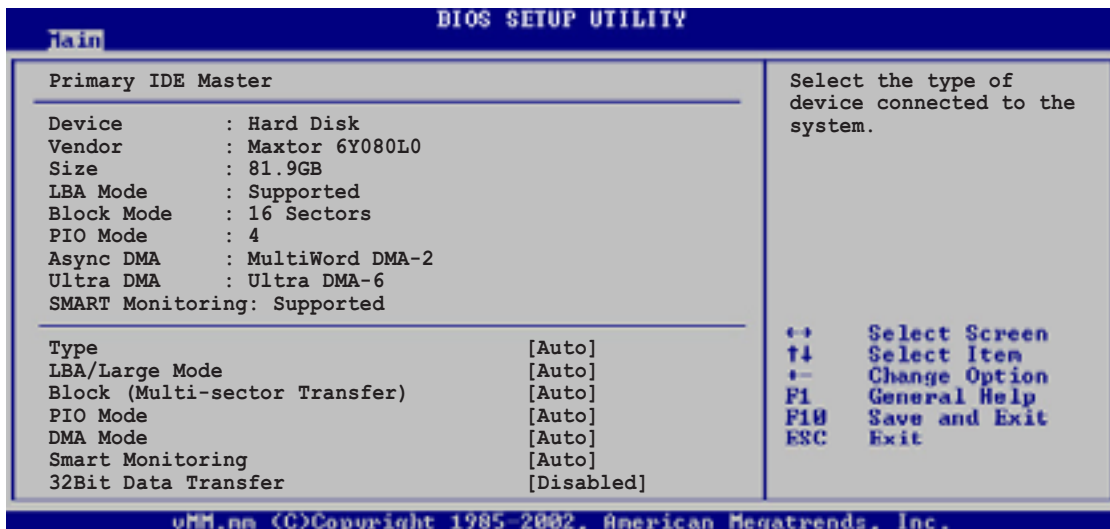

The values opposite the dimmed items (Device, Vendor, Size, LBA Mode, Block Mode, PIO Mode, Async DMA, Ultra DMA, and SMART monitoring) are auto-detected by BIOS and are not user-configurable. These items show N/A if no IDE/Serial ATA device is installed in the system.

Type [Auto]

Selects the type of IDE drive. Setting to Auto allows automatic selection of the appropriate IDE device type. Select CDROM if you are specifically configuring a CD-ROM drive. Select ARMD (ATAPI Removable Media Device) if your device is either a ZIP, LS-120, or MO drive. Configuration options: [Not Installed] [Auto] [CDROM] [ARMD]

LBA/Large Mode [Auto]

Enables or disables the LBA mode. Setting to Auto enables the LBA mode if the device supports this mode, and if the device was not previously formatted with LBA mode disabled. Configuration options: [Disabled] [Auto]

Block (Multi-sector Transfer) [Auto]

Enables or disables data multi-sectors transfers. When set to Auto, the data transfer from and to the device occurs multiple sectors at a time if the device supports multi-sector transfer feature. When set to Disabled, the data transfer from and to the device occurs one sector at a time. Configuration options: [Disabled] [Auto]

PIO Mode [Auto]

Selects the PIO mode. Configuration options: [Auto] [0] [1] [2] [3] [4]

DMA Mode [Auto]

Selects the DMA mode. Configuration options: [Auto] [SWDMA0] [SWDMA1] [SWDMA2] [MWDMA0] [MWDMA1] [MWDMA2] [UDMA0] [UDMA1] [UDMA2] [UDMA3] [UDMA4] [UDMA5] [UDMA6]

SMART Monitoring [Auto]

Sets the Smart Monitoring, Analysis, and Reporting Technology.
Configuration options: [Auto] [Disabled] [Enabled]

32Bit Data Transfer [Disabled]

Enables or disables 32-bit data transfer.
Configuration options: [Disabled] [Enabled]

5.3.4 System Information

This menu gives you an overview of the general system specifications. The items in this menu are auto-detected by BIOS.

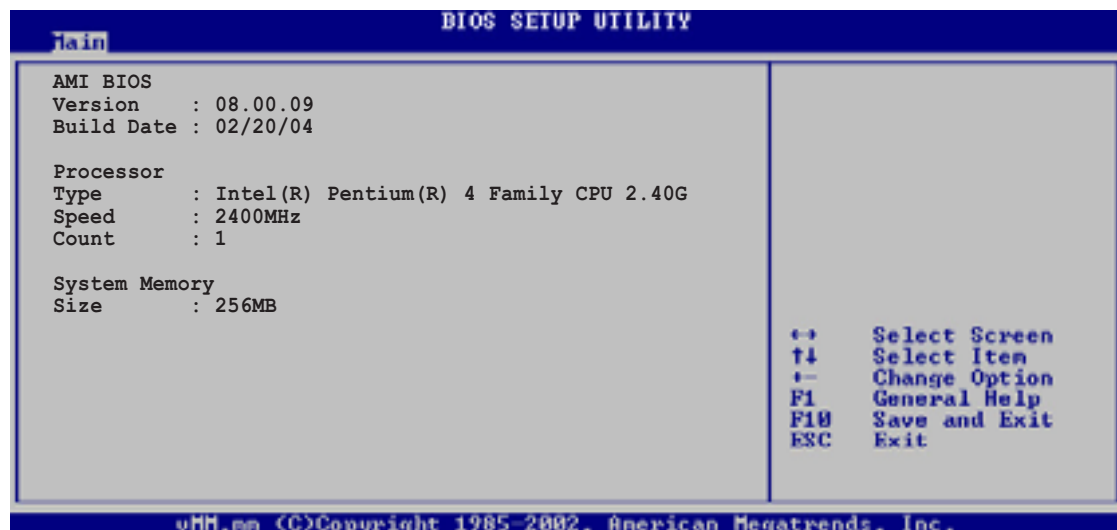

AMIBIOS

This item displays the auto-detected BIOS information.

Processor

This item displays the auto-detected CPU specification.

System Memory

This item displays the auto-detected system memory.

5.4 Advanced menu

The Advanced menu items allow you to change the settings for the CPU and other system devices.



Take caution when changing the settings of the Advanced menu items. Incorrect field values may cause the system to malfunction.

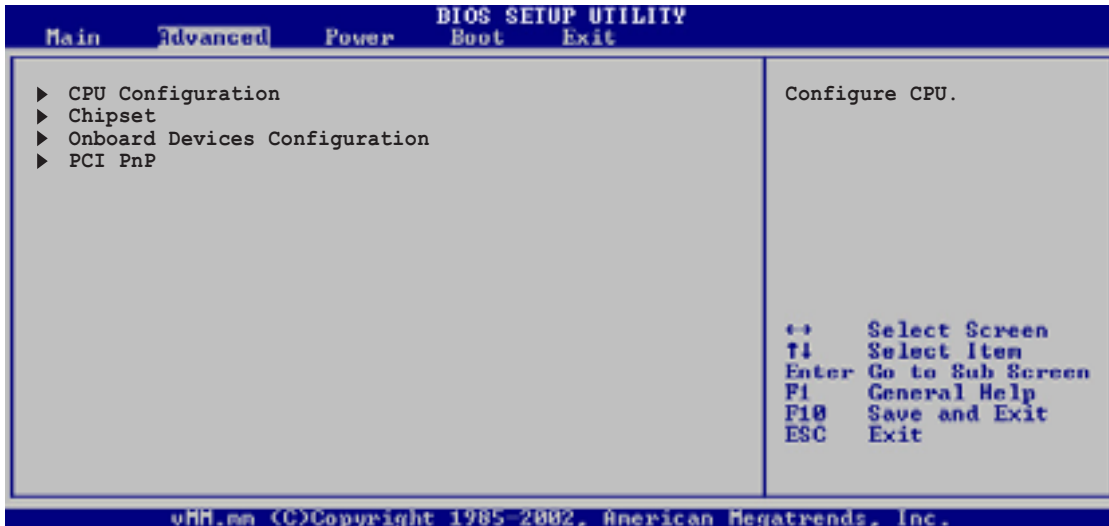

5.4.1 CPU Configuration

The items in this menu show the CPU-related information auto-detected by BIOS.

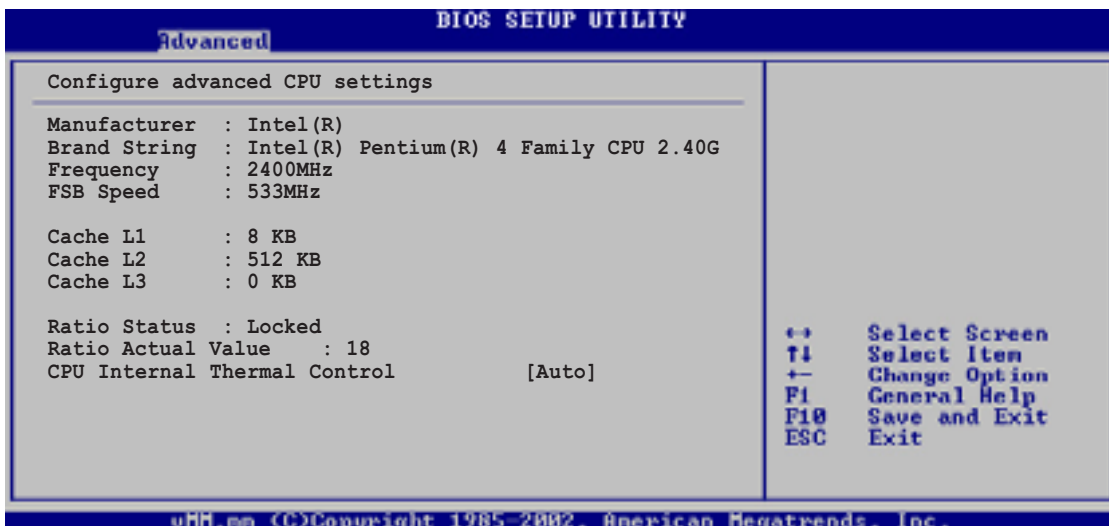

CPU Internal Thermal Control [Auto]

This item allows you to activate the CPU Internal Thermal control feature. Configuration options: [Auto] [Disabled]

5.4.2 Chipset

The Chipset menu items allow you to change the advanced chipset settings. Select an item then press Enter to display the sub-menu.

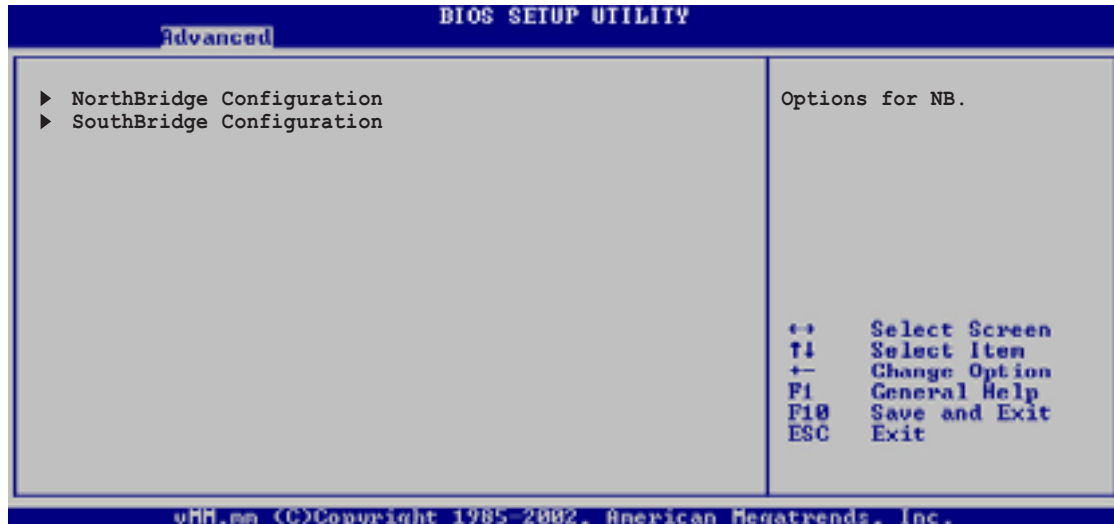

NorthBridge Configuration

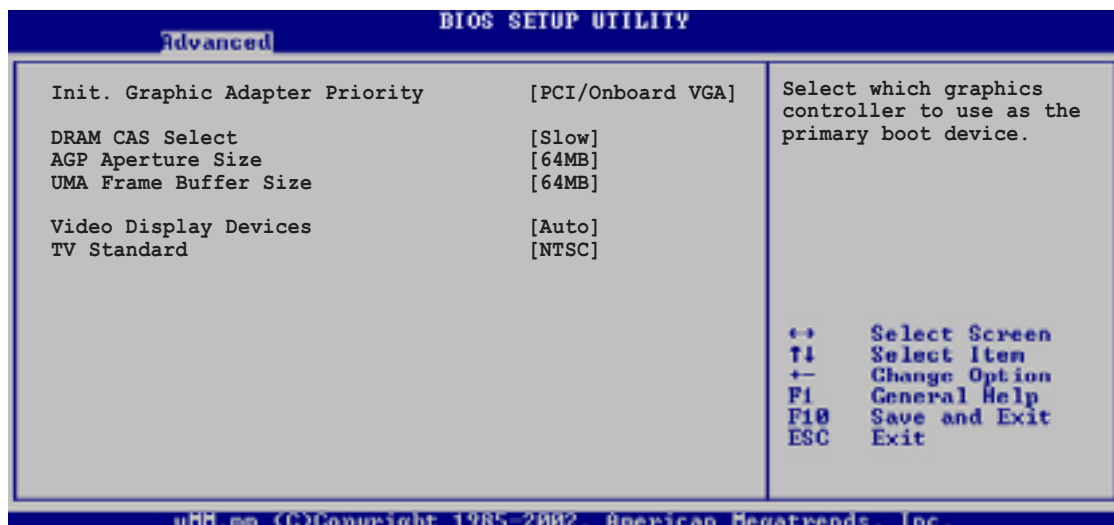

Init. Graphic Adapter Priority [PCI/Onboard VGA]

This option allows you to select the graphics controller to use as primary boot device. Configuration options: [PCI/Onboard VGA] [Onboard VGA/PCI]

DRAM CAS Select [Slow]

This option allows you to select the DRAM CAS speed. Configuration options: [Slow] [Fast]

AGP Aperture Size [64MB]

This option allows you to select the size of mapped memory for AGP graphic data. Configuration options: [32MB] [64MB] [128MB] [256MB] [512MB]

UMA Frame Buffer Size [64MB]

This option allows you to select the size of the onboard graphics controller memory use. Configuration options: [8MB] [16MB] [32MB] [64MB] [128MB] [None]

Video Display Device [Auto]

This parameter allows you to select the type of video display device you intend to use. Configuration options: [Auto] [CRT Only] [DFP Only] [TV Only] [CRT and DFP]

TV Standard [NTSC]

Select the TV standard according to your location.

Configuration options: [NTSC] [PAL] [PAL-M] [PAL-60] [NTSC-JAP] [PAL-CN] [PAL-N] [SCART_RGB]

SouthBridge Configuration

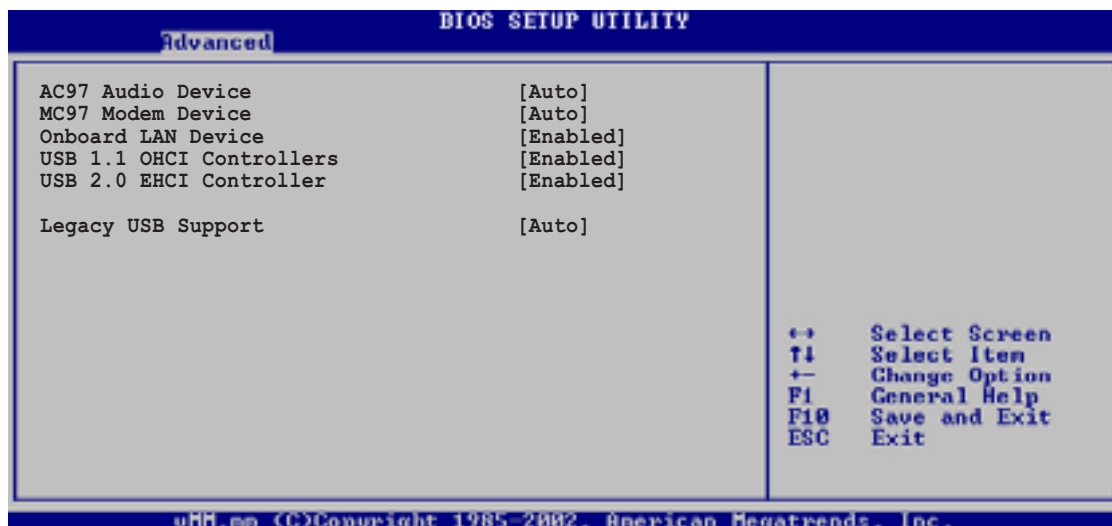

AC97 Audio Device [Auto]

Setting to [Auto] allows the BIOS to detect the onboard audio device. The onboard audio controller is enabled when an audio device is detected.

Configuration options: [Auto] [Disabled]

MC97 Audio Device [Auto]

Setting to [Auto] allows the BIOS to detect an installed modem device. The onboard modem controller is enabled if a modem is detected.

Configuration options: [Auto] [Disabled]

OnBoard LAN Device [Enabled]

This option allows you to enable or disable the onboard LAN controller.

Configuration options: [Disabled] [Enabled]

USB 1.1 OHCI Controllers [Enabled]

This option allows you to enable or disable the USB 1.1 OHCI controller.
Configuration options: [Disabled] [Enabled]

USB 2.0 EHCI Controller [Enabled]

This option allows you to enable or disable the USB 2.0 EHCI controller.
Configuration options: [Enabled] [Disabled]

Legacy USB Support [Auto]

Allows you to enable or disable support for legacy USB devices. Setting to [Auto] allows the system to detect the presence of USB devices at startup. If a legacy USB device is detected, the legacy USB support is enabled. If none, the legacy USB support is disabled.
Configuration options: [Disabled] [Enabled] [Auto]

5.4.3 Onboard Devices Configuration

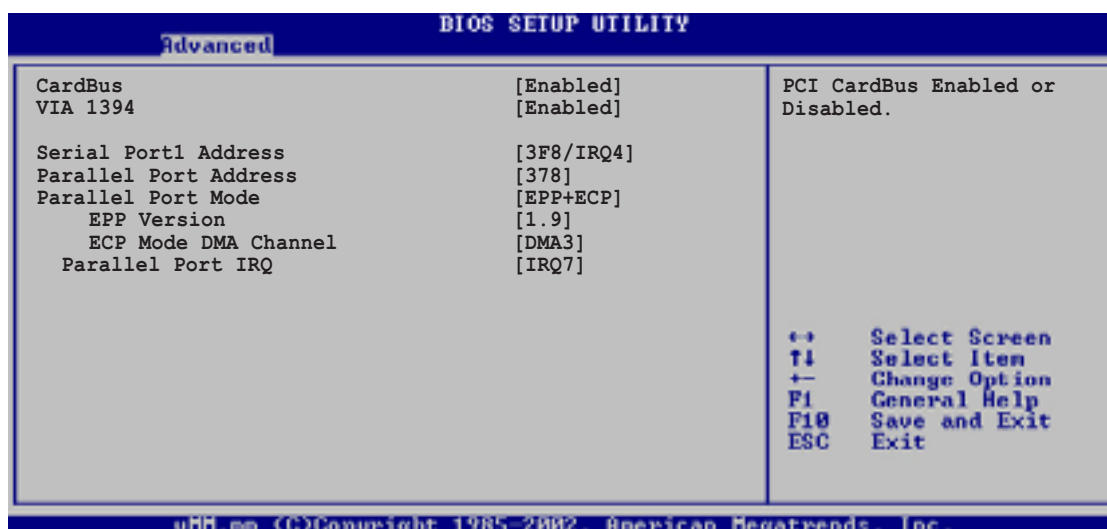

CardBus [Enabled]

Allows you to enable or disable the onboard PCMCIA card reader.
Configuration options: [Enabled] [Disabled]

VIA 1394 [Enabled]

Allows you to enable or disable the onboard 1394 controller.
Configuration options: [Enabled] [Enabled]

Serial Port1 Address [3F8/IRQ4]

Allows you to select the Serial Port1 base address.
Configuration options: [Disabled] [3F8/IRQ4] [2F8/IRQ3] [3E8/IRQ4] [2E8/IRQ3]

Parallel Port Address [378]

Allows you to select the Parallel Port base addresses.

Configuration options: [378] [278] [3BC] [Disabled]

Parallel Port Mode [EPP+ECP]

Allows you to select the Parallel Port mode.

Configuration options: [Normal] [EPP] [ECP] [EPP+ECP]

EPP Version [1.9]

Allows selection of the Parallel Port EPP version. This item appears only when the **Parallel Port Mode** is set to **EPP**.

Configuration options: [1.9] [1.7]

ECP Mode DMA Channel [DMA3]

Allows selection of the Parallel Port ECP DMA channel. This item appears only when the **Parallel Port Mode** is set to **ECP**.

Configuration options: [DMA0] [DMA1] [DMA3]

Parallel Port IRQ [IRQ7]

Allows you to select the Parallel Port IRQ.

Configuration options: [IRQ5] [IRQ7]

5.4.4 PCIPnP

The PCIPnP menu items allow you to change the advanced settings for PCI/PnP devices. The menu includes setting IRQ and DMA channel resources for either PCI/PnP or legacy ISA devices, and setting the memory size block for legacy ISA devices.



Take caution when changing the settings of the PCI PnP menu items. Incorrect field values may cause the system to malfunction.

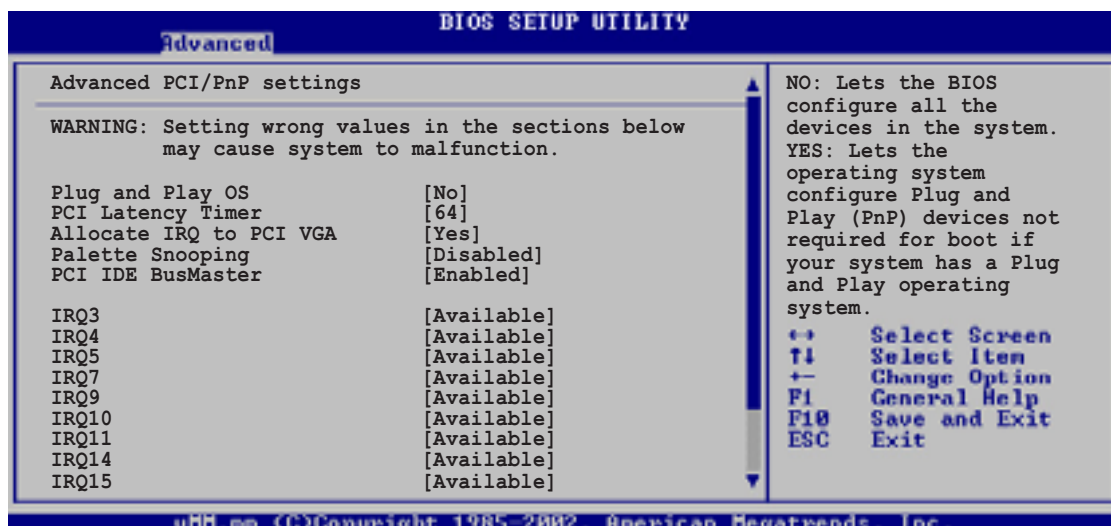

Plug and Play O/S [No]

When set to [No], BIOS configures all the devices in the system. When set to [Yes] and if you installed a Plug & Play operating system, the operating system configures the Plug & Play devices not required for boot.

Configuration options: [No] [Yes]

PCI Latency Timer [64]

Allows you to select the value in units of PCI clocks for the PCI device latency timer register. Configuration options: [32] [64] [96] [128] [160] [192] [224] [248]

Allocate IRQ to PCI VGA [Yes]

When set to [Yes], BIOS assigns an IRQ to PCI VGA card if the card requests for an IRQ. When set to [No], BIOS does not assign an IRQ to the PCI VGA card even if requested. Configuration options: [No] [Yes]

Palette Snooping [Disabled]

When set to [Enabled], the palette snooping feature informs the PCI devices that an ISA graphics device is installed in the system so that the latter can function correctly. Setting to [Disabled] deactivates this feature. Configuration options: [Disabled] [Enabled]

PCI IDE BusMaster [Enabled]

Allows BIOS to use PCI bus mastering when reading/writing to IDE devices. Configuration options: [Disabled] [Enabled]

IRQ xx [Available]

When set to [Available], the specific IRQ is free for use of PCI/PnP devices. When set to [Reserved], the IRQ is reserved for legacy ISA devices. Configuration options: [Available] [Reserved]

5.5 Power menu

The Power menu items allow you to change the settings for the Advanced Power Management (APM). Select an item then press Enter to display the configuration options.



5.5.1 Suspend Mode [S1(POS) & S3 (STR)]

Allows you to select the ACPI state to be used for system suspend.

Configuration options: [S1 (POS) Only] [S1 (POS) & S3 (STR)]

5.5.2 Repost Video on S3 Resume [Yes]

Determines whether to invoke VGA BIOS POST on S3/STR resume.

Configuration options: [Yes] [No]

5.5.3 ACPI 2.0 Support [No]

Allows you to add more tables for ACPI 2.0 specifications.

Configuration options: [No] [Yes]

5.5.4 ACPI APIC Support [Enabled]

Allows you to enable or disable the ACPI support in the ASIC. When set to Enabled, the ACPI APIC table pointer is included in the RSDT pointer list.

Configuration options: [Disabled] [Enabled]

5.5.5 APM Configuration



Restore on AC Power Loss [Power Off]

When set to [Power Off], the system goes into off state after an AC power loss. When set to Power On, the system goes on after an AC power loss. Configuration options: [Power Off] [Power On]

Power On with PS/2 Keyboard [Disabled]

This parameter allows you to use specific keys on the keyboard to turn on the system. This feature requires an ATX power supply that provides at least 1A on the +5VSB lead. Configuration options: [Disabled] [Enabled]

Power On with PS/2 Mouse [Disabled]

This parameter allows you to use the PS/2 mouse to turn on the system. This feature requires an ATX power supply that provides at least 1A on the +5VSB lead. Configuration options: [Disabled] [Enabled]

RTC Resume [Disabled]

Allows you to enable or disable RTC to generate a wake event. When this item is set to Enabled, the items RTC Alarm Date, RTC Alarm Hour, RTC Alarm Minute, and RTC Alarm Second appear with set values. Configuration options: [Disabled] [Enabled]

5.5.6 Hardware Monitor

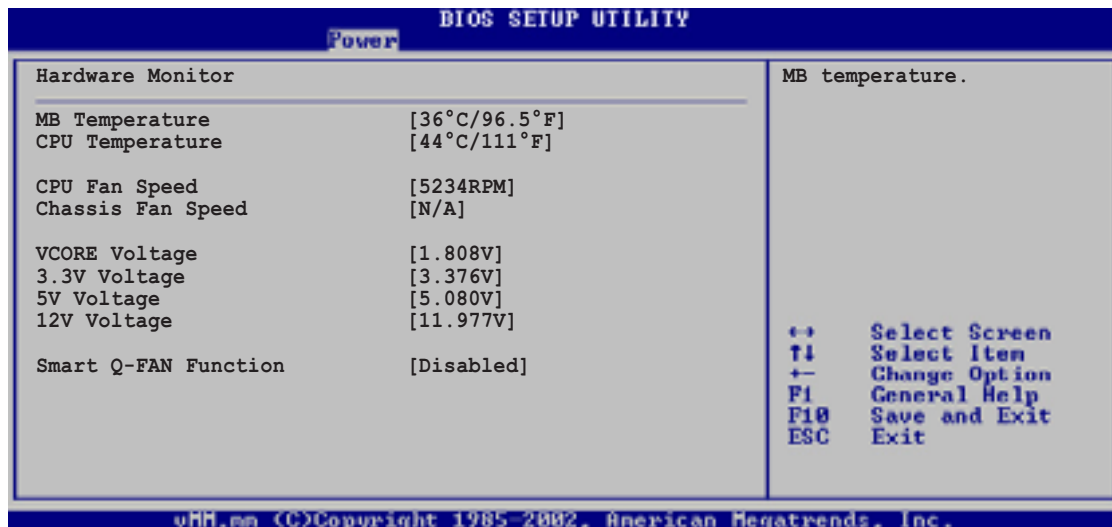

MB Temperature [xxx°C/xxx°F]

CPU Temperature [xxx°C/xxx°F]

The onboard hardware monitor automatically detects and displays the motherboard and CPU temperatures. Select [Disabled] if you do not wish to display the detected temperatures.

CPU Fan Speed [xxxxRPM] or [N/A]

Chassis Fan Speed [xxxxRPM] or [N/A]

The onboard hardware monitor automatically detects and displays the CPU, chassis, and power fan speeds in rotations per minute (RPM). If any of the fans is not connected to the motherboard, the specific field shows N/A.

VCORE Voltage, 3.3V Voltage, 5V Voltage, 12V Voltage

The onboard hardware monitor automatically detects the voltage output through the onboard voltage regulators.



If any of the monitored items is out of range, the following error message appears: "Hardware Monitor found an error. Enter Power setup menu for details". You will then be prompted to "Press F1 to continue or DEL to enter SETUP".

Smart Q-FAN Function [Disabled]

This item allows you to enable or disable the ASUS Smart Q-Fan feature that smartly adjusts the fan speeds for more efficient system operation. Configuration options: [Disabled] [Enabled]



The following items appear only when the **Smart Q-Fan Function** item is set to Enabled.

Fan Auto Mode Start Voltage [5.0V]

This item allows you to select the voltage for the auto start fan feature. The fan starts when the system reaches the specified voltage.

Configuration options: [4.0V] [4.5V] [5.0V] [5.5V] [6.0V]

Fan Auto Mode Start Temp [30°C]

Select the temperature for the auto start fan feature. The fan starts when the system reaches the specified temperature.

Configuration options: [25°C]...[75°C]

Fan Auto Mode Full Speed Temp [70°C]

Select the temperature for the fan to rotate in full speed. The fan switches to full speed when the system reaches the specified temperature.

Configuration options: [25°C]...[75°C]

5.6 Boot menu

The Boot menu items allow you to change the system boot options. Select an item then press Enter to display the sub-menu.

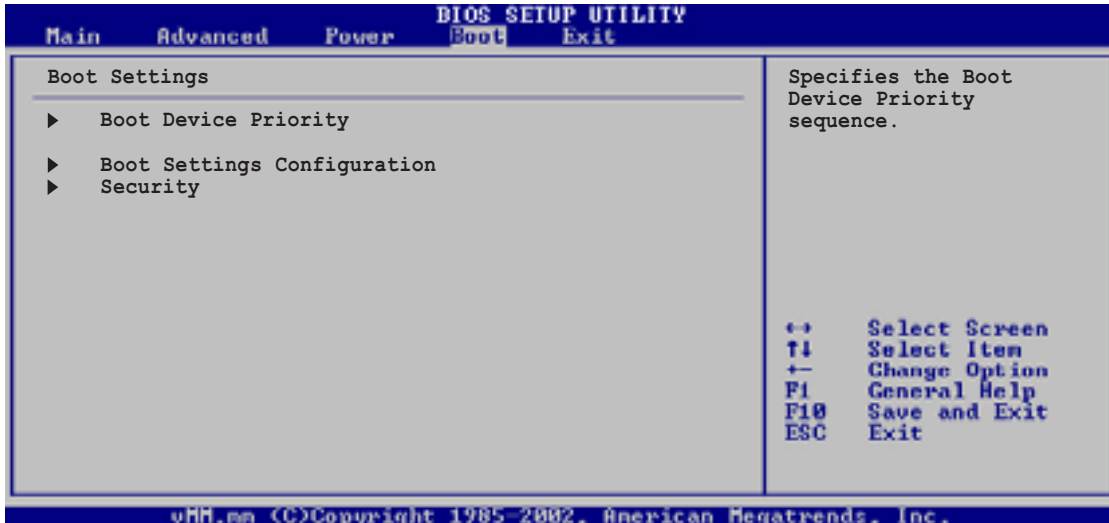

5.6.1 Boot Device Priority

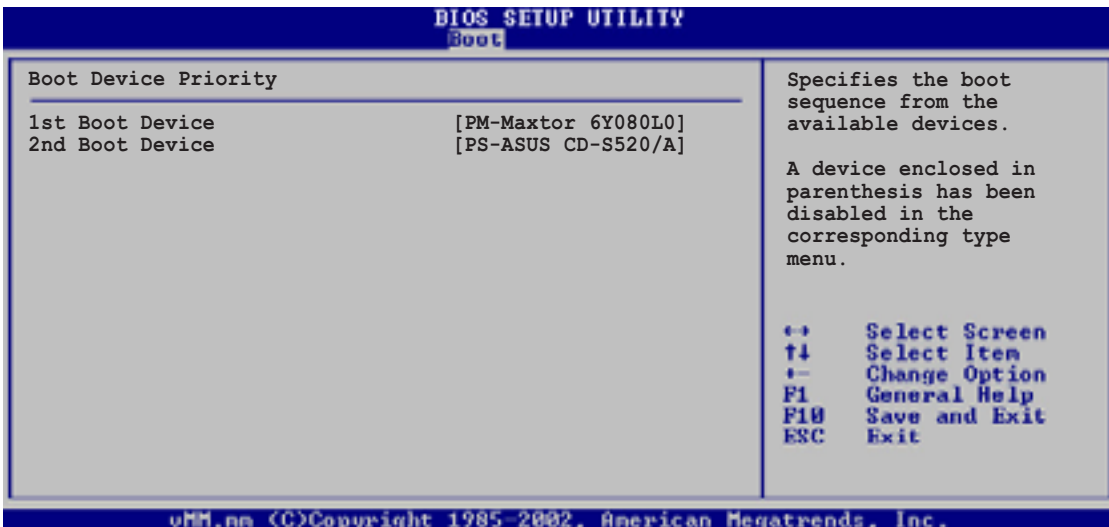

1st Boot Device

2nd Boot Device

These items specify the boot device priority sequence from the available devices. The number of device items that appear on the screen depends on the the number of devices installed in your system.

Configuration options: [xxxxx Drive] [Disabled]

5.6.2 Boot Settings Configuration

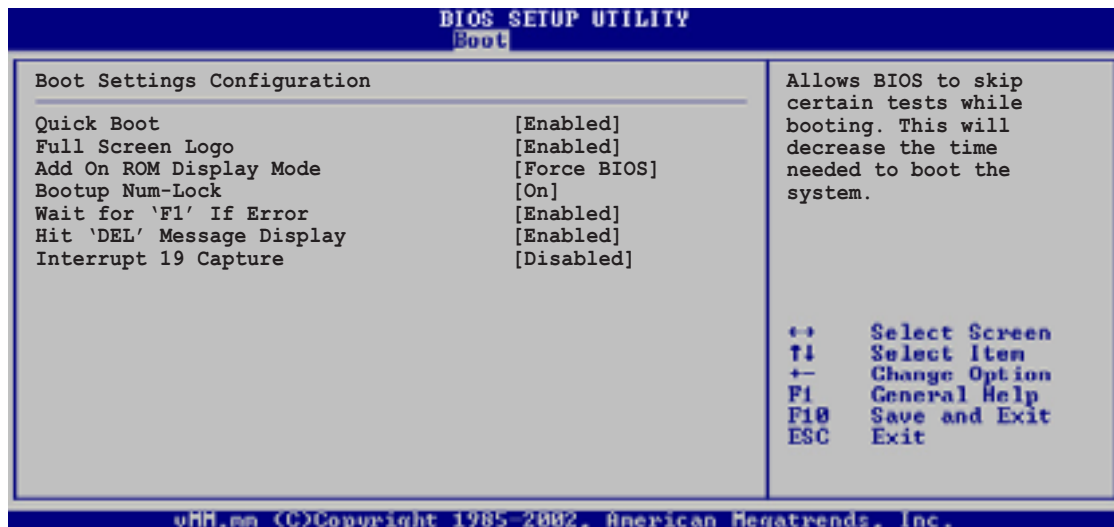

Quick Boot [Enabled]

Enabling this item allows the BIOS to skip some power on self tests (POST) while booting to decrease the time needed to boot the system. When set to [Disabled], BIOS performs all the POST items. Configuration options: [Enabled] [Disabled]

Full Screen Logo [Enabled]

This allows you to enable or disable the full screen logo display feature. Configuration options: [Enabled] [Disabled]



Make sure that the Full Screen Logo item is set to [Enabled] if you wish to use the ASUS MyLogo2™ feature.

Add On ROM Display Mode [Force BIOS]

Sets the display mode for option ROM. Configuration options: [Force BIOS] [Keep Current]

Bootup Num-Lock [On]

Allows you to select the power-on state for the NumLock. Configuration options: [On] [Off]

Wait for 'F1' If Error [Enabled]

When set to Enabled, the system waits for F1 key to be pressed when error occurs. Configuration options: [Enabled] [Disabled]

Hit 'DEL' Message Display [Enabled]

When set to Enabled, the system displays the message "Press DEL to run Setup" during POST. Configuration options: [Enabled] [Disabled]

Interrupt 19 Capture [Disabled]

When set to [Enabled], this function allows the option ROMs to trap Interrupt 19. Configuration options: [Disabled] [Enabled]

5.6.3 Security

The Security menu items allow you to change the system security settings. Select an item then press Enter to display the configuration options.



Change Supervisor Password

Select this item to set or change the supervisor password. The Supervisor Password item on top of the screen shows the default **Not Installed**. After you have set a password, this item shows **Installed**.

To set a **Supervisor Password**:

1. Select the Change Supervisor Password item and press Enter.
2. On the password box that appears, type a password composed of letters and/or numbers, then press Enter. Your password should have at least six characters.
3. Confirm the password when prompted.

The message "**Password Installed**" appears after you have successfully set your password.

The Supervisor Password item now shows **Installed**.

To change the supervisor password, follow the same steps as in setting a user password.

To clear the supervisor password, select the Change Supervisor Password then press Enter. The message "**Password Uninstalled**" appears.



If you forget your BIOS password, you can clear it by erasing the CMOS Real Time Clock (RTC) RAM. See section 4.3 “Jumper” for information on how to erase the RTC RAM.

After you have set a supervisor password, the other items appear to allow you to change other security settings.



User Access Level (Full Access)

This item allows you to select the access restriction to the Setup items. Configuration options: [No Access] [View Only] [Limited] [Full Access]

No Access prevents user access to the Setup utility.

View Only allows access but does not allow change to any field.

Limited allows change to only selected fields, such as Date and Time.

Full Access allows viewing and changing all the fields in the Setup utility.

Change User Password

Select this item to set or change the user password. The User Password item on top of the screen shows the default **Not Installed**. After you have set a password, this item shows **Installed**.

To set a **User Password**:

1. Select the Change User Password item and press Enter.
2. On the password box that appears, type a password composed of letters and/or numbers, then press Enter. Your password should have at least six characters.
3. Confirm the password when prompted.

The message “**Password Installed**” appears after you have successfully set your password.

The User Password item now shows **Installed**.

To change the user password, follow the same steps as in setting a user password

Clear User Password

Select this item if you wish to clear the user password.

Password Check [Setup]

When set to [Setup], BIOS checks for user password when accessing the Setup utility. When set to [Always], BIOS checks for user password both when accessing Setup and booting the system.

Configuration options: [Setup] [Always]

5.7 Exit menu

The Exit menu items allow you to load the optimal or failsafe default values for the BIOS items, and save or discard your changes to the BIOS items.

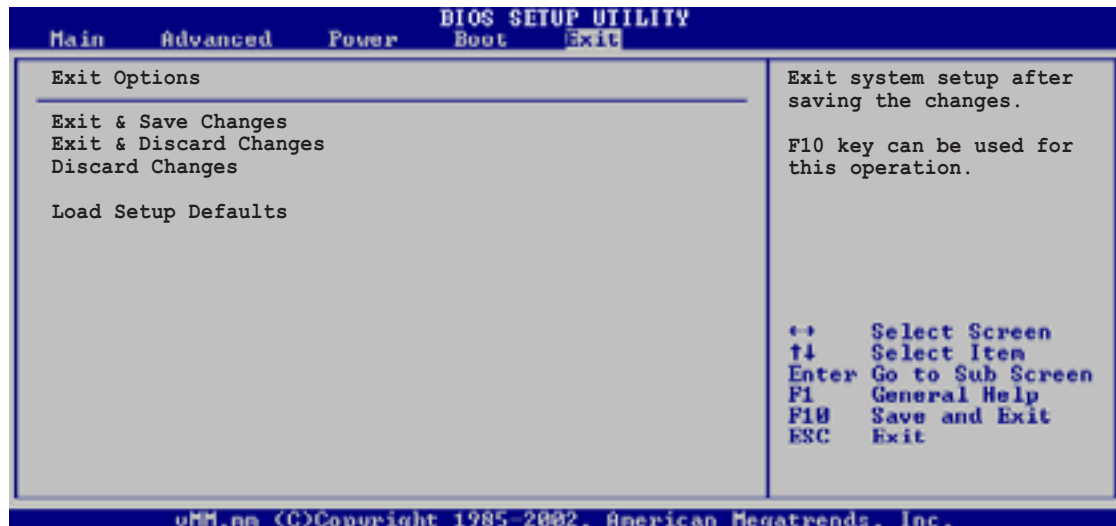

Pressing <Esc> does not immediately exit this menu. Select one of the options from this menu or <F10> from the legend bar to exit.

Exit & Save Changes

Once you are finished making your selections, choose this option from the Exit menu to ensure the values you selected are saved to the CMOS RAM. The CMOS RAM is sustained by an onboard backup battery and stays on even when the PC is turned off. When you select this option, a confirmation window appears. Select [Yes] to save changes and exit.



If you attempt to exit the Setup program without saving your changes, the program prompts you with a message asking if you want to save your changes before exiting. Pressing <Enter> saves the changes while exiting.

Exit & Discard Changes

Select this option only if you do not want to save the changes that you made to the Setup program. If you made changes to fields other than system date, system time, and password, the BIOS asks for a confirmation before exiting.

Discard Changes

This option allows you to discard the selections you made and restore the previously saved values. After selecting this option, a confirmation appears. Select [Yes] to discard any changes and load the previously saved values.

Load Setup Defaults

This option allows you to load the default values for each of the parameters on the Setup menus. When you select this option or if you press <F5>, a confirmation window appears. Select [Yes] to load the default values. Select **Exit Saving Changes** or make other changes before saving the values to the non-volatile RAM.