

ASUS[®]
Pundit
Barebone System
Model Pundit-PE3



E2113

Revised Edition V2
May 2005

Copyright © 2005 ASUSTeK COMPUTER INC. All Rights Reserved.

No part of this manual, including the products and software described in it, may be reproduced, transmitted, transcribed, stored in a retrieval system, or translated into any language in any form or by any means, except documentation kept by the purchaser for backup purposes, without the express written permission of ASUSTeK COMPUTER INC. ("ASUS").

Product warranty or service will not be extended if: (1) the product is repaired, modified or altered, unless such repair, modification of alteration is authorized in writing by ASUS; or (2) the serial number of the product is defaced or missing.

ASUS PROVIDES THIS MANUAL "AS IS" WITHOUT WARRANTY OF ANY KIND, EITHER EXPRESS OR IMPLIED, INCLUDING BUT NOT LIMITED TO THE IMPLIED WARRANTIES OR CONDITIONS OF MERCHANTABILITY OR FITNESS FOR A PARTICULAR PURPOSE. IN NO EVENT SHALL ASUS, ITS DIRECTORS, OFFICERS, EMPLOYEES OR AGENTS BE LIABLE FOR ANY INDIRECT, SPECIAL, INCIDENTAL, OR CONSEQUENTIAL DAMAGES (INCLUDING DAMAGES FOR LOSS OF PROFITS, LOSS OF BUSINESS, LOSS OF USE OR DATA, INTERRUPTION OF BUSINESS AND THE LIKE), EVEN IF ASUS HAS BEEN ADVISED OF THE POSSIBILITY OF SUCH DAMAGES ARISING FROM ANY DEFECT OR ERROR IN THIS MANUAL OR PRODUCT.

SPECIFICATIONS AND INFORMATION CONTAINED IN THIS MANUAL ARE FURNISHED FOR INFORMATIONAL USE ONLY, AND ARE SUBJECT TO CHANGE AT ANY TIME WITHOUT NOTICE, AND SHOULD NOT BE CONSTRUED AS A COMMITMENT BY ASUS. ASUS ASSUMES NO RESPONSIBILITY OR LIABILITY FOR ANY ERRORS OR INACCURACIES THAT MAY APPEAR IN THIS MANUAL, INCLUDING THE PRODUCTS AND SOFTWARE DESCRIBED IN IT.

Products and corporate names appearing in this manual may or may not be registered trademarks or copyrights of their respective companies, and are used only for identification or explanation and to the owners' benefit, without intent to infringe.

Table of contents

Notices	vi
Safety information	vii
About this guide	viii
System package contents	x
Chapter 1: System Introduction	
1.1 Welcome!	1-2
1.2 Front panel	1-2
1.3 Rear panel	1-4
1.4 Internal components	1-6
Chapter 2: Basic Installation	
2.1 Preparation	2-2
2.2 Before you proceed	2-2
2.3 Removing the covers	2-3
2.3.1 Removing the system cover	2-3
2.3.2 Removing the front panel assembly	2-4
2.4 Installing the CPU	2-5
2.5 Installing a DIMM	2-9
2.5.1 Memory configurations	2-9
2.5.2 Installing a DIMM	2-11
2.5.3 Removing a DIMM	2-11
2.6 Installing an expansion card	2-12
2.6.1 Expansion slots	2-12
2.6.2 Expansion card installation	2-12
2.7 Installing an optical drive	2-15
2.8 Installing hard disk drives (HDDs)	2-17
2.8.1 Hard disk drive bays	2-17
2.8.2 SATA hard disk drive installation	2-17
2.8.3 IDE hard disk drive installation	2-19
2.8.4 Uninstalling a hard disk drive	2-19
2.9 Replacing the covers	2-20
2.9.1 Replacing the front panel assembly	2-20
2.9.2 Replacing the system cover	2-21

Table of contents

2.10	Installing the foot stands	2-22
2.11	Selecting the voltage	2-23
2.12	Connecting external devices	2-23

Chapter 3: Getting started

3.1	Installing an operating system	3-2
3.2	Support CD information	3-2
3.2.1	Running the support CD	3-2
3.2.2	Drivers menu	3-3
3.2.3	Utilities menu	3-4
3.2.4	ASUS contact information	3-5
3.2.5	Other information	3-6

Chapter 4: Motherboard info

4.1	Motherboard overview	4-2
4.2	Jumpers	4-3
4.3	Connectors	4-5
4.3.1	Rear panel connectors	4-5
4.3.2	Internal connectors	4-5

Chapter 5: BIOS setup

5.1	Managing and updating your BIOS	5-2
5.1.1	ASUS CrashFree BIOS 2 utility	5-2
5.1.2	ASUS Update utility	5-3
5.2	BIOS setup program	5-6
5.2.1	BIOS menu screen	5-7
5.2.2	Menu bar	5-7
5.2.3	Navigation keys	5-7
5.2.4	Menu items	5-8
5.2.5	Sub-menu items	5-8
5.2.6	Configuration fields	5-8
5.2.7	Pop-up window	5-8
5.2.8	Scroll bar	5-8
5.2.9	General help	5-8

Table of contents

5.3	Main menu	5-9
5.3.1	System Time	5-9
5.3.2	System Date	5-9
5.3.3	Primary, Third, and Fourth IDE Master/Slave	5-10
5.3.4	IDE Configuration	5-11
5.3.5	System Information	5-12
5.4	Advanced menu	5-13
5.4.1	USB Configuration	5-13
5.4.2	CPU Configuration	5-14
5.4.3	Advanced Chipset Settings	5-16
5.4.4	Onboard Devices Configuration	5-17
5.4.5	PCI PnP	5-18
5.5	Power menu	5-20
5.5.1	Suspend Mode	5-20
5.5.2	Repost Video on S3 Resume	5-20
5.5.3	ACPI 2.0 Support	5-20
5.5.4	ACPI APIC Support	5-20
5.5.5	APM Configuration	5-21
5.5.6	Hardware Monitor	5-23
5.6	Boot menu	5-25
5.6.1	Boot Device Priority	5-25
5.6.2	Boot Settings Configuration	5-26
5.6.3	Security	5-27
5.7	Exit menu	5-30

Appendix: CPU features

Intel® Hyper-Threading Technology	A-2
---	-----

Notices

Federal Communications Commission Statement

This device complies with Part 15 of the FCC Rules. Operation is subject to the following two conditions:

- This device may not cause harmful interference, and
- This device must accept any interference received including interference that may cause undesired operation.

This equipment has been tested and found to comply with the limits for a Class B digital device, pursuant to Part 15 of the FCC Rules. These limits are designed to provide reasonable protection against harmful interference in a residential installation. This equipment generates, uses and can radiate radio frequency energy and, if not installed and used in accordance with manufacturer's instructions, may cause harmful interference to radio communications. However, there is no guarantee that interference will not occur in a particular installation. If this equipment does cause harmful interference to radio or television reception, which can be determined by turning the equipment off and on, the user is encouraged to try to correct the interference by one or more of the following measures:

- Reorient or relocate the receiving antenna.
- Increase the separation between the equipment and receiver.
- Connect the equipment to an outlet on a circuit different from that to which the receiver is connected.
- Consult the dealer or an experienced radio/TV technician for help.



WARNING! The use of shielded cables for connection of the monitor to the graphics card is required to assure compliance with FCC regulations. Changes or modifications to this unit not expressly approved by the party responsible for compliance could void the user's authority to operate this equipment.

Canadian Department of Communications Statement

This digital apparatus does not exceed the Class B limits for radio noise emissions from digital apparatus set out in the Radio Interference Regulations of the Canadian Department of Communications.

This class B digital apparatus complies with Canadian ICES-003.

Safety information

Electrical safety

- To prevent electrical shock hazard, disconnect the power cable from the electrical outlet before relocating the system.
- When adding or removing devices to or from the system, ensure that the power cables for the devices are unplugged before the signal cables are connected.
- If the power supply is broken, do not try to fix it by yourself. Contact a qualified service technician or your retailer.

Operation safety

- Before installing devices into the system, carefully read all the documentation that came with the package.
- Before using the product, make sure all cables are correctly connected and the power cables are not damaged. If you detect any damage, contact your dealer immediately.
- To avoid short circuits, keep paper clips, screws, and staples away from connectors, slots, sockets and circuitry.
- Avoid dust, humidity, and temperature extremes. Do not place the product in any area where it may become wet. Place the product on a stable surface.
- If you encounter technical problems with the product, contact a qualified service technician or your retailer.

Lithium-Ion Battery Warning

CAUTION: Danger of explosion if battery is incorrectly replaced. Replace only with the same or equivalent type recommended by the manufacturer. Dispose of used batteries according to the manufacturer's instructions.

VORSICHT: Explosionsgefahr bei unsachgemäßen Austausch der Batterie. Ersatz nur durch denselben oder einem vom Hersteller empfohlenem ähnlichen Typ. Entsorgung gebrauchter Batterien nach Angaben des Herstellers.

LASER PRODUCT WARNING
CLASS 1 LASER PRODUCT

About this guide

Audience

This guide provides general information and installation instructions about the ASUS barebone system. This guide is intended for experienced users and integrators with hardware knowledge of personal computers.

How this guide is organized

This guide contains the following parts:

1. Chapter 1: System introduction

This chapter gives a general description of the barebone system. The chapter lists the system features including introduction on the front and rear panel, and internal components.

2. Chapter 2: Basic installation

This chapter provides step-by-step instructions on how to install components in the system.

3. Chapter 3: Getting started

This chapter helps you power up the system and install drivers and utilities from the support CD.

4. Chapter 4: Motherboard info

This chapter gives information about the motherboard that comes with the system. This chapter includes the motherboard layout, jumper settings, and connector locations.

5. Chapter 5: BIOS setup

This chapter tells how to change system settings through the BIOS Setup menus and describes the BIOS parameters.

6. Appendix: CPU features

The Appendix describes the CPU features and technologies that the motherboard supports.

Where to find more information

Refer to the following sources for additional information and for product and software updates.

1. ASUS Websites

The ASUS websites worldwide provide updated information on ASUS hardware and software products. Refer to the ASUS contact information.

2. Optional Documentation

Your product package may include optional documentation, such as warranty flyers, that may have been added by your dealer. These documents are not part of the standard package.

Conventions used in this guide



WARNING: Information to prevent injury to yourself when trying to complete a task.



CAUTION: Information to prevent damage to the components when trying to complete a task.



IMPORTANT: Instructions that you **MUST** follow to complete a task.



NOTE: Tips and additional information to aid in completing a task.

Typography

Bold text

Indicates a menu or an item to select.

Italics

Used to emphasize a word or a phrase.

<Key>

Keys enclosed in the less-than and greater-than sign means that you must press the enclosed key.

Example: <Enter> means that you must press the Enter or Return key.

<Key1+Key2+Key3>

If you must press two or more keys simultaneously, the key names are linked with a plus sign (+).

Example: <Ctrl+Alt+D>

Command

Means that you must type the command exactly as shown, then supply the required item or value enclosed in brackets.

Example: At the DOS prompt, type the command line:

format a:

System package contents

Check your barebone system package for the following items.



If any of the items is damaged or missing, contact your retailer immediately.

1. ASUS Pundit-PE3 barebone system with

- ASUS motherboard
- 275 W PFC power supply unit

2. Accessories

- Foot stand and screw (1 pair) for vertical placement
- Rubber stand (x 4) for horizontal placement
- Hard disk drive screw (x 8)
- Optical drive screw (x 2)
- Rubber washer (x 8)

3. Cables

- AC power cable
- IDE cable
- Serial ATA signal cable (x 2)

4. Support CD

5. User guide

6. Optional component

- Optical drive (*CD-ROM/CD-RW/DVD-ROM/DVD-RW*)

Chapter 1

This chapter gives a general description of the barebone system. The chapter lists the system features including introduction on the front and rear panel, and internal components.



ASUS Pundit-PE3

System introduction

1.1 Welcome!

Thank you for choosing the ASUS Pundit-PE3!

The ASUS Pundit-PE3 is an all-in-one barebone system with powerful and flexible features.

The system comes in a stylish mini-tower casing, and powered by the ASUS motherboard that supports the Intel® Pentium® 4 processor in the 775-land package with 800 MHz FSB and up to 4 GB system memory.



With audio capabilities, extensive connectivity, and Fast Ethernet LAN, Pundit-PE3 is designed for the sophisticated. The system's ergonomic design allows vertical or horizontal placement so you can maximize your desktop space.



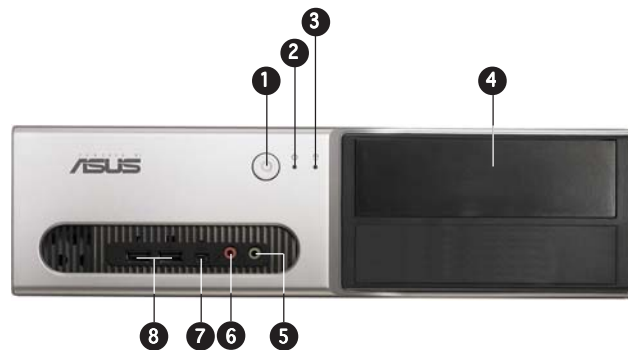

With these and many more, the Pundit-PE3 definitely delivers the cutting edge technology for your computing and multimedia needs.

1.2 Front panel

The front panel includes the system and audio control buttons and LEDs.









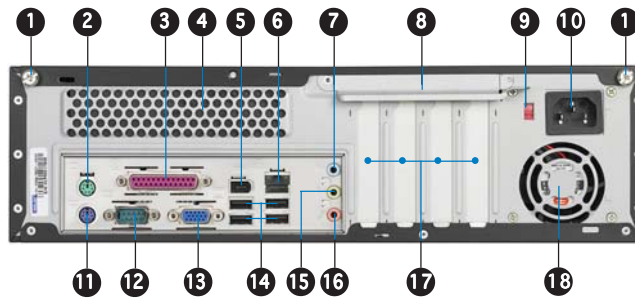

1. **Power button** . Press this button to turn the system on or off.
2. **Power LED** . This LED lights up to indicate that the system is ON.
3. **HDD LED** . This LED lights up when data is being read from or written to the hard disk drive.
4. **5.25-inch drive bay cover**. This covers the 5.25-inch drive bay for an optical drive.



5. **Headphone port** . This port is a combined headphone (Line Out) and S/PDIF Out port. The port functions as audio Line Out when you connect a headphone with a stereo mini-plug. The port functions as S/PDIF Out port when you connect an external audio output device that supports the S/PDIF feature.
6. **Microphone port** . This Mic (pink) port connects a microphone.
7. **4-pin IEEE 1394a port** . This port provides high-speed connectivity for IEEE 1394a-compliant audio/video devices, storage peripherals, and other PC devices.
8. **USB 2.0 ports** . These Universal Serial Bus 2.0 (USB 2.0) ports are available for connecting USB 2.0 devices such as a mouse, printer, scanner, camera, PDA, and others.

1.3 Rear panel

The system rear panel includes the power connector and several I/O ports that allow convenient connection of devices.



1. **Cover screws.** Secures the system cover.
2. **PS/2 mouse port** . This green 6-pin connector is for a PS/2 mouse.
3. **Parallel port** . This 25-pin port connects a printer, scanner, or other devices.
4. **Air vents.** Provide ventilation for the system.
5. **6-pin IEEE 1394a port** . Provides high-speed connectivity for IEEE 1394a-compliant audio/video devices, storage peripherals, and other consumer electronic devices.
6. **LAN (RJ-45) port** . This port allows Fast Ethernet connection to a Local Area Network (LAN) through a network hub.
7. **Line In port** . This Line In (light blue) port connects a tape player or other audio sources. In 6-channel mode, the function of this port becomes Low Frequency Enhanced Output/Center.
8. **Metal bracket lock.** Secures the expansion slot/card metal brackets.
9. **Voltage selector.** Allows you to adjust the system input voltage according to the voltage supply in your area. See the “Voltage selector” section on page 2-24 before adjusting this switch.
10. **Power connector.** Connects the power plug is for the power cable and plug.
11. **PS/2 keyboard port** . This purple 6-pin connector is for a PS/2 keyboard.
12. **Serial port** . Connects a mouse, modem, or other devices that conforms with serial specification.
13. **VGA port** . Connects a VGA monitor.

- 14. USB 2.0 ports** . These Universal Serial Bus 2.0 (USB 2.0) ports are available for connecting USB 2.0 devices such as a mouse, printer, scanner, camera, PDA, and others.
- 15. Line Out port** . This Line Out (lime) port connects a headphone or a speaker. In 4/6-channel mode, the function of this port becomes Front Speaker Out.
- 16. Microphone port** . This Microphone (pink) port connects a microphone. In 4/6-channel mode, the function of this port becomes Surround Speaker.



The functions of the Line Out, Line In, and Microphone ports change when you select the 6-channel configuration. Refer to the table below for audio ports function variation.

Audio ports function variation

Port	Headphone/2-Channel	4-Channel	6-Channel
Light Blue	Line In	No function	LFE* Output/Center
Lime	Line Out	Front Speaker Out	Front Speaker Out
Pink	Mic In	Surround	Surround

* Low Frequency Enhanced

- 17. PCI slot metal brackets.** Covers the PCI Express x1 and PCI slots.
- 18. Power fan vents.** Provide ventilation for the power supply unit.

1.4 Internal components

The illustration below is the internal view of the system when you remove the top cover and the chassis support bracket. The installed components are labeled for your reference. Proceed to Chapter 2 for instructions on installing additional system components.



1. 5.25-inch empty optical drive bay
2. Front panel cover
3. Optical drive lock
4. Hard disk drive bays
5. Hard disk drive lock
6. Power supply unit
7. PCI Express x1 slot
8. PCI slots
9. ASUS motherboard
10. Metal bracket lock
11. LGA775 socket (under the CPU fan and heatsink assembly)
12. CPU fan and heatsink assembly
13. DIMM sockets

Chapter 2

This chapter provides step-by-step instructions on how to install components in the system.



ASUS Pundit-PE3

Basic installation

2.1 Preparation

Before you proceed, make sure that you have all the components you plan to install in the system.

Basic components to install

1. Central processing unit (CPU)
2. DDR Dual Inline Memory Module (DIMM)
3. Expansion card(s)
4. Hard disk drive
5. Optical drive

2.2 Before you proceed

Take note of the following precautions before you install components into the system.



- Use a grounded wrist strap or touch a safely grounded object or a metal object, such as the power supply case, before handling components to avoid damaging them due to static electricity.
- Hold components by the edges to avoid touching the ICs on them.
- Whenever you uninstall any component, place it on a grounded antistatic pad or in the bag that came with the component.

The system motherboard comes with an onboard standby power LED. This LED lights up to indicate that the system is ON, in sleep mode or in soft-off mode, and not powered OFF. Unplug the power cable from the power outlet and make sure that the standby power LED is OFF before installing any system component.

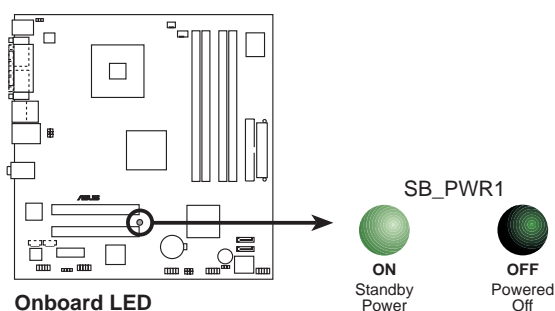

2.3 Removing the covers

2.3.1 Removing the system cover

To remove the cover and metal chassis support:

1. On the rear panel, locate the two thumb screws that secure the cover to the chassis.
2. Remove the cover screws. Keep the screws for later use.



3. Slightly pull the cover toward the rear panel until the cover hooks disengage from the chassis holes.
4. Lift the system cover, then set aside.



5. Lift the expansion card lock to a 90°-100° angle.
6. Lift the chassis support bracket to a 45° angle, then carefully pull to release. Set the chassis support bracket aside.



2.3.2 Removing the front panel assembly

To remove the front panel assembly:

1. Place the system vertically.
2. Locate the front panel assembly hooks.
3. Pull the hooks outward to release the front panel assembly.

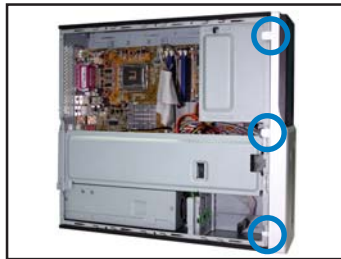

4. Swing the left edge of the front panel assembly outward.
5. Unhook the hinge-like tabs from the holes on the right side of the chassis to detach.

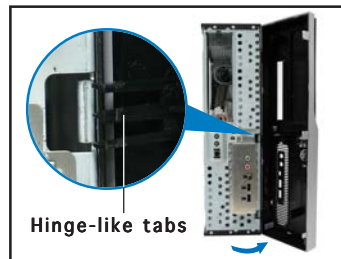

Do not use too much force when removing the front panel assembly.

2.4 Installing the CPU

The ASUS motherboard comes with a surface mount LGA775 socket designed for the Intel® Pentium® 4 processor in the 775-land package.



- Your boxed Intel® Pentium® 4 LGA775 processor package should come with installation instructions for the CPU, heatsink, and the retention mechanism. If the instructions in this section do not match the CPU documentation, follow the latter.
- Check your motherboard to make sure that the socket contacts are not bent. Contact your retailer immediately if you see any damage to the socket contacts/motherboard components. ASUS will shoulder the cost of repair only if the damage is shipment/transit-related.
- The product warranty does not cover damage to the socket contacts resulting from incorrect CPU installation or removal.

1. Locate the CPU socket on the motherboard.

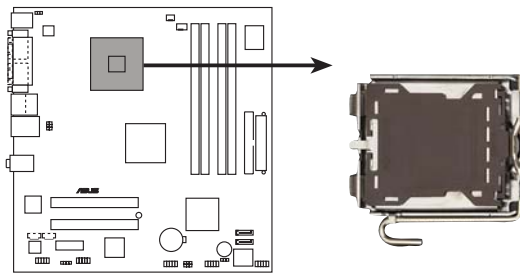

CPU Socket 775



Before installing the CPU, make sure that the cam box is facing towards you and the load lever is on your left.

2. Press the load lever with your thumb (A), then move it to the left (B) until it is released from the retention tab.

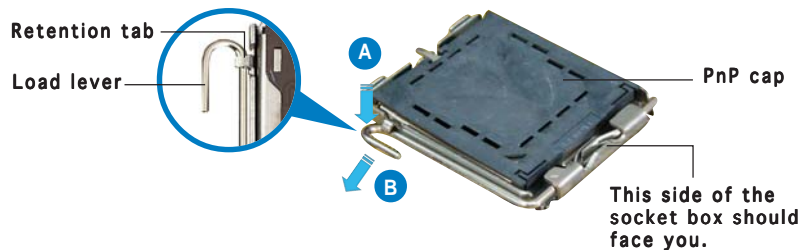

To prevent damage to the socket pins, do not remove the PnP cap unless you are installing a CPU.

3. Lift the load lever in the direction of the arrow to a 135° angle.

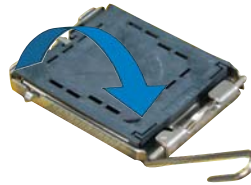

4. Lift the load plate with your thumb and forefinger to a 100° angle (A), then push the PnP cap from the load plate window to remove (B).

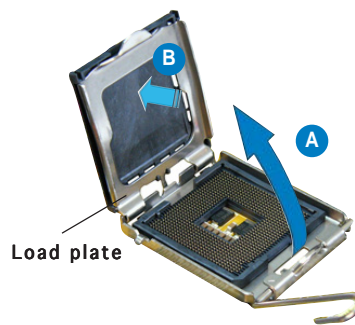

5. Position the CPU over the socket, making sure that the gold triangle is on the bottom-left corner of the socket. The socket alignment key should fit into the CPU notch.

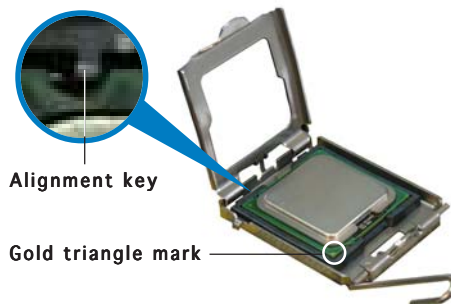



The CPU fits in only one correct orientation. DO NOT force the CPU into the socket to prevent bending the connectors on the socket and damaging the CPU!

6. Close the load plate (A), then push the load lever (B) until it snaps into the retention tab.

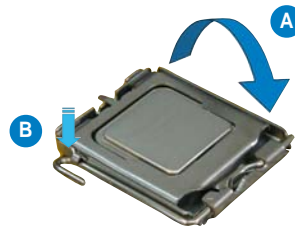

The motherboard supports Intel® Pentium® 4 LGA775 processors with Hyper-Threading Technology. Refer to the Appendix for more information.

Installing the CPU fan and heatsink assembly

To install the CPU fan and heatsink assembly:

1. Place the heatsink on top of the installed CPU, making sure that the four fasteners match the holes on the motherboard.



Orient the heatsink and fan assembly such that the CPU fan cable is closest to the CPU fan connector.



Fastener
Motherboard hole

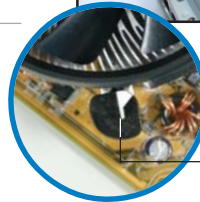

Narrow end
of the groove



Make sure to orient each fastener with the narrow end of the groove pointing outward. (The photo shows the groove shaded for emphasis.)

2. Push down two fasteners at a time in a diagonal sequence to secure the heatsink and fan assembly in place.

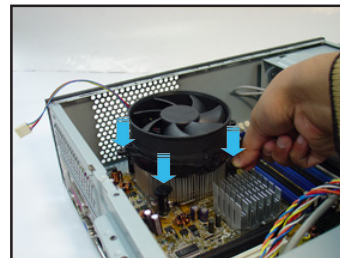

3. Connect the CPU fan cable to the connector on the motherboard labeled CPU_FAN1.

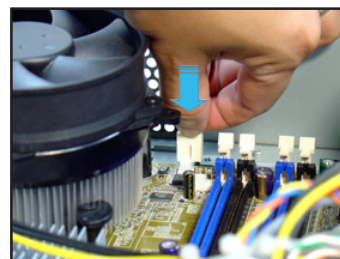

2.5 Installing a DIMM

The system motherboard comes with four Double Data Rate (DDR) Dual Inline Memory Module (DIMM) sockets.

The following figure illustrates the location of the sockets:

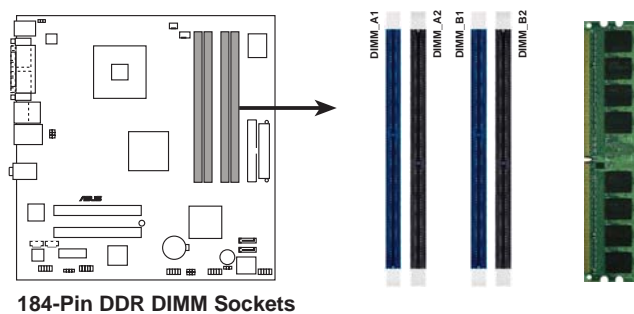

Channel	Sockets
Channel A	DIMM_A1 and DIMM_A2
Channel B	DIMM_B1 and DIMM_B2

2.5.1 Memory configurations

You may install up to 4 GB system memory using 256 MB, 512 MB, and 1 GB DDR DIMMs.



- Installing DDR DIMMs other than the recommended configurations may cause memory sizing error or system boot failure. Use any of the recommended configurations in the table on the next page.
- Install only **identical** (the same type and size) DDR DIMM in DIMM_A and DIMM_B.
- Always install DIMMs with the same CAS latency. For optimum compatibility, we recommend that you obtain memory modules from the same vendor.
- Due to chipset resource allocation, the system may detect less than 4 GB system memory when you installed four 1 GB DDR memory.
- This motherboard does not support memory modules made up of 128 Mb chips or double-sided x16 memory modules.

DDR400 Qualified Vendors List

Size	Vendor	Model	Brand	Side(s)	Component	CL	DIMM support (optional)		
							A	B	C
256 MB	KINGSTON	KVR400X64C3A/256	Hynix	SS	HY5DU56822BT-D43	—	•	•	•
512 MB	KINGSTON	KVR400X64C3A/512	Hynix	DS	HY5DU56822BT-D43	—	•	•	•
256 MB	KINGSTON	KVR400X64C3A/256	Infineon	SS	HYB25D256800BT-5B	—	•	•	•
512 MB	KINGSTON	KVR400X64C3A/512	Infineon	DS	HYB25D256809BT-5B	—	•	•	•
256 MB	KINGSTON	KVR400X64C3A/256	KINGSTON	SS	D3208DL2T-5	—	•	•	•
512 MB	KINGSTON	KVR400X64C3A/512	KINGSTON	DS	D328DIB-50	—	•	•	•
512 MB	KINGSTON	KHX3200A/512	N/A	DS	Heat-Sink Package	—	•	•	•
256 MB	SAMSUNG	M368L3223ETM-CCC	SAMSUNG	SS	K4H560838E-TCCC	—	•	•	•
512 MB	SAMSUNG	M368L6423ETM-CCC	SAMSUNG	DS	K4H560838E-TCCC	3	•	•	•
256 MB	SAMSUNG	M368L3223FTN-CCC	SAMSUNG	SS	K4H560838F-TCCC	3	•	•	•
512 MB	SAMSUNG	M368L6423FTN-CCC	SAMSUNG	DS	K4H560838F-TCCC	—	•	•	•
256 MB	Hynix	HYMD232646B8J-D43 AA	Hynix	SS	HY5DU56822BT-D43	3	•	•	•
512 MB	Hynix	HYMD264646B8J-D43 AA	Hynix	DS	HY5DU56822BT-D43	—	•	•	•
256 MB	MICRON	MT8VDDT3264AG-40BCB	MICRON	SS	MT46V32M8TG-SBC	—	•	•	•
512 MB	MICRON	MT16VDDT6464AG-40BCB	MICRON	DS	MT46V32M8TG-SBC	—	•	•	•
256 MB	Infineon	HYS64D32300GU-5-B	Infineon	SS	HYB25D256800BT-5B	3	•	•	•
512 MB	Infineon	HYS64D64320GU-5-B	Infineon	DS	HYB25D256800BT-5B	3	•	•	•
256 MB	Infineon	HYS64D32300HU-5-C	Infineon	SS	HYB25D256800CE-5C	3	•	•	•
512 MB	Infineon	HYS64D64320HU-5-C	Infineon	DS	HYB25D256800CE-5C	—	•	•	•
256 MB	CORSAIR	CMX256A-3200C2PT	Winbond	SS	W942508BH-5	2	•	•	•
512 MB	CORSAIR	CMX512-3200C2	Winbond	DS	Heat-Sink Package	2	•	•	•
512 MB	CORSAIR	VS512MB400	VALUE seLecTDS	VS32M8-5		2.5	•	•	•

SS - Single-sided

DS - Double-sided

CL- CAS Latency

DIMM support:

A - supports one module inserted into either slot, in a Single-channel memory configuration.

B - supports one pair of modules inserted into either the blue slots or the black slots as one pair of Dual-channel memory configuration.

C - supports four modules inserted into the blue and black slots as two pairs of Dual-channel memory configuration.



Visit the ASUS website (www.asus.com) for the latest DDR Qualified Vendors List.

2.5.2 Installing a DIMM



Make sure to unplug the power supply before adding or removing DIMMs or other system components. Failure to do so may cause severe damage to both the motherboard and the components.

Follow these steps to install a DIMM.

1. Locate the DIMM sockets in the motherboard.
2. Unlock a DIMM socket by pressing the retaining clips outward.
3. Align a DIMM on the socket such that the notch on the DIMM matches the break on the socket.

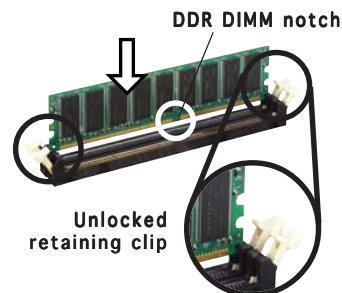

A DDR DIMM is keyed with a notch so that it fits in only one direction. DO NOT force a DIMM into a socket to avoid damaging the DIMM.

4. Firmly insert the DIMM into the socket until the retaining clips snap back in place and the DIMM is properly seated.

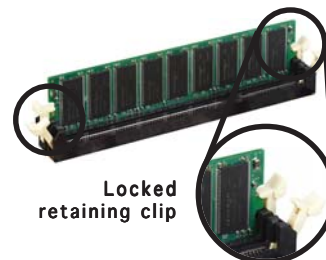

2.5.3 Removing a DIMM

Follow these steps to remove a DIMM.

1. Simultaneously press the retaining clips outward to unlock the DIMM.

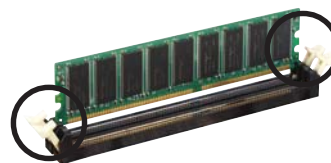

Support the DIMM lightly with your fingers when pressing the retaining clips. The DIMM might get damaged when it flips out with extra force.

2. Remove the DIMM from the socket.

2.6 Installing an expansion card

In the future, you may need to install expansion cards. The motherboard has two PCI and one PCI Express™ x1 slots. The following sub-sections describe the slots and the expansion cards that they support.



The system supports **low profile** PCI and PCI Express x1 cards. You can only install low profile expansion cards on this system. Ask your retailer for details.

2.6.1 Expansion slots

PCI slots

The PCI slots support cards such as a LAN card, SCSI card, USB card, and other cards that comply with PCI specifications.

PCI Express x1 slot

This motherboard supports PCI Express x1 network cards, SCSI cards and other cards that comply with the PCI Express specifications. The following figure shows a network card installed on the PCI Express x1 slot.



Before installing an expansion card, read the documentation that came with it and make the necessary hardware settings for the card.

2.6.2 Expansion card installation



Make sure to unplug the power cord before adding or removing expansion cards. Failure to do so may cause you physical injury and damage the motherboard.

To install an expansion card:

1. Lay the system on its side on a flat and stable surface.
2. Lift the expansion card lock to a 90°-100° angle, then remove the chassis support bracket.

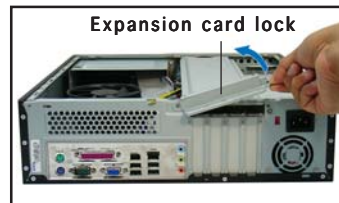

3. Remove the metal cover opposite the slot that you intend to use.

PCI Express x1 slot
PCI slots

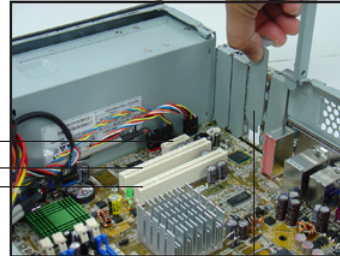

Metal bracket

4. Align the card connector with the slot and press firmly until the card is completely seated on the slot.

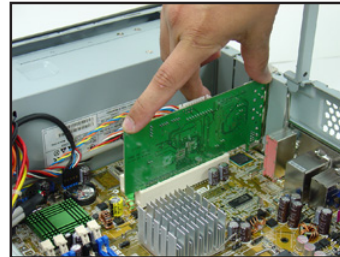

5. If you have already installed a hard disk drive, replace the chassis support bracket; otherwise, install other components before replacing the chassis support bracket.

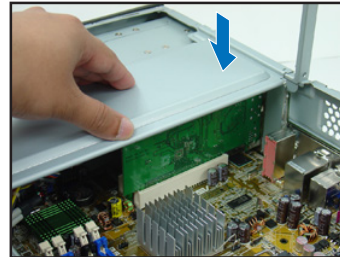

6. Replace the expansion card lock to secure the card to the chassis.

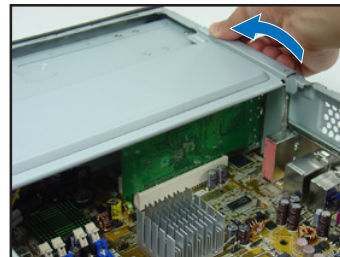

Standard interrupt assignments

IRQ	Standard Function
0	System Timer
1	Keyboard Controller
2	Programmable Interrupt
4	Communications Port (COM1)
6	Floppy Disk Controller
7*	Printer Port (LPT1)
8	System CMOS/Real Time Clock
9*	ACPI Mode when used
10*	IRQ Holder for PCI Steering
11*	IRQ Holder for PCI Steering
12*	PS/2 Compatible Mouse Port
13	Numeric Data Processor
14*	Primary IDE Channel

* These IRQs are usually available for ISA or PCI devices.

IRQ assignments for the system motherboard

	A	B	C	D	E	F	G	H
PCI slot 1	—	—	—	—	—	used	—	—
PCI slot 2	—	—	—	—	—	—	used	—
PCI Express x1 slot1	—	shared	—	—	—	—	—	—
Onboard USB controller 1	—	—	—	—	—	—	—	shared
Onboard USB controller 2	—	—	—	shared	—	—	—	—
Onboard USB controller 3	—	—	shared	—	—	—	—	—
Onboard USB controller 4	shared	—	—	—	—	—	—	—
Onboard USB 2.0 controller	—	—	—	—	—	—	—	shared
Onboard LAN controller	—	—	—	—	shared	—	—	—
Onboard Audio controller	shared	—	—	—	—	—	—	—



When using a PCI card on shared slots, ensure that the drivers support “Share IRQ” or that the cards do not need IRQ assignments; otherwise, conflicts will arise between the two PCI groups, making the system unstable and the card inoperable.

2.7 Installing an optical drive

The system comes with a 5.25-inch drive bay for an optical drive.

If you plan to install an IDE hard disk drive, set the optical drive as a slave device before installing it to the system. Refer to the optical drive documentation for details on how to set the drive as slave device.

To install an optical drive:

1. Remove the front panel assembly following the instructions in section “2.3.2 Removing the front panel assembly”.

2. Drive a screw on the top right screw hole on both sides of the drive. The screw holes are approximately 5 cm from the drive front panel and 2 cm from the drive base.

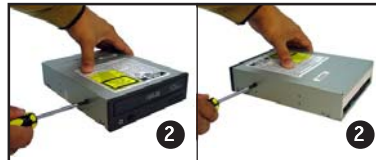

3. Lay the system on its side in a flat and stable surface.
4. Carefully pull the IDE and audio cables and plugs out from the bay until the cables are long enough to connect to the drive.

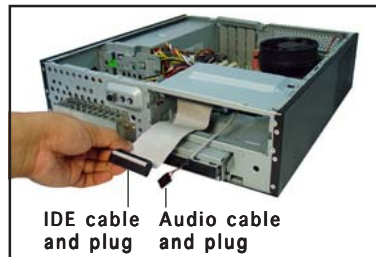

5. Connect the IDE cable to the IDE interface at the back of the drive. Match the red stripe on the cable with Pin 1 on the IDE interface.
6. Connect the optical drive audio cable to the 4-pin connector at the back of the optical drive.



The IDE and audio plugs are pre-connected to the primary IDE and internal audio connectors on the motherboard. If you disconnected these plugs, refer to page 4-5 and 4-7 for their respective locations.

7. Carefully push the optical drive all the way into the bay until the optical drive lock clicks.
8. Connect a 4-pin power plug from the power supply unit to the power connector at the back of the drive.

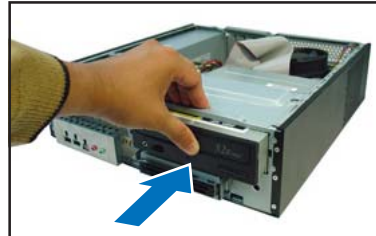

Uninstalling the optical drive

In the future, you may have to upgrade or replace a defective optical drive.

To uninstall the optical drive:

1. Remove the front panel assembly following the instructions in section “2.3.2 Removing the front panel assembly”.
2. Locate the optical drive screw lock.



3. Push the lock to release the optical drive screw (A), then slightly pull the drive out from the bay (B).

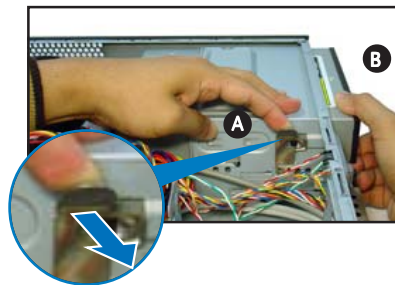

4. Disconnect the IDE, audio, and power cables and plugs from the back of the drive.
5. Pull out the drive completely from the bay, then replace it following the instructions in the previous section.



2.8 Installing hard disk drives (HDDs)

The system comes with two 3.5-inch drive bays (labeled 1 and 2) for installation of two Serial ATA hard disk drives or one IDE HDD (if you have installed an optical drive).

2.8.1 Hard disk drive bays

The drive bays incorporate a screw-less design that allows you to install and remove a hard disk drive without driving screws on the chassis. Each drive bay has a HDD screw lock and four screw rails (two on each side of the bay) that trap the HDD screws and secure the drive in the place.

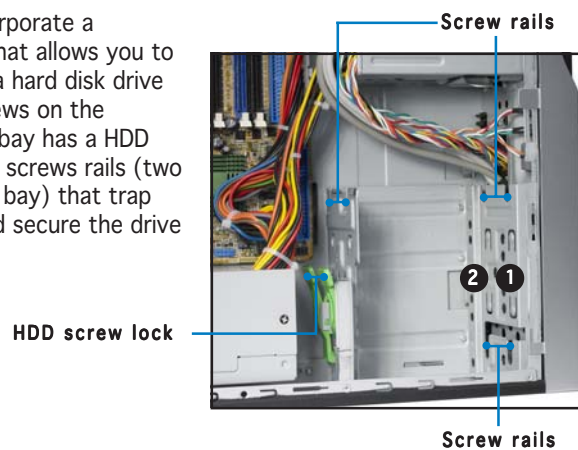

When installing **one** hard disk drive, install it on the upper HDD bay.

2.8.2 SATA hard disk drive installation

To install a SATA hard disk drive:

1. Insert the rubber washers to the HDD screws. Refer to the illustration on the right.
2. Drive four screws (two on each side of the drive) on the drive screw holes.

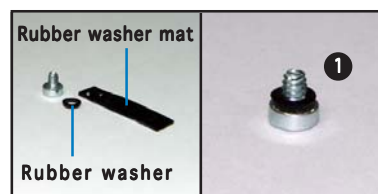

3. Connect one end of the supplied 7-pin SATA cable to the SATA connector at the back of the drive, then connect the other end to a SATA connector on the motherboard. See page 4-6 for the location of the SATA connectors.

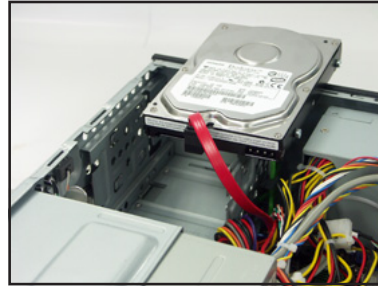

4. Connect the 15-pin SATA power plug from the power supply unit to the power connector at the back of the drive.

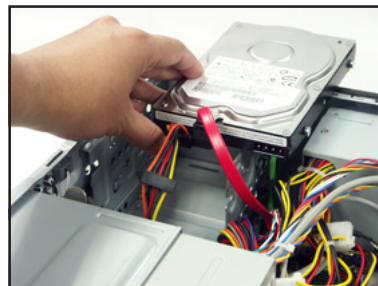

5. Place the HDD on the tray. Make sure that the HDD screws are aligned with the screw holes and rails.



6. When the HDD screws align with the screw rails, push the drive carefully until it is completely flushed on the bay. The HDD screw lock clicks to indicate that the drive is properly in place.

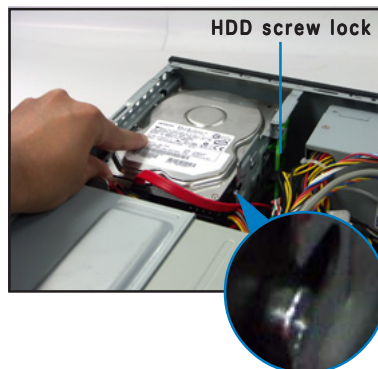

2.8.3 IDE hard disk drive installation

Set the IDE HDD as master device before connecting the IDE cable and power plug. Refer to the HDD documentation for details.

To install an IDE hard disk drive:

1. Follow steps 1 to 2 of the previous section.
2. Connect the IDE cable (gray connector) to the IDE interface at the back of the drive. Match the red stripe on the cable with Pin 1 on the IDE interface.
3. Connect a power cable from the power supply unit to the power connector at the back of the drive.
4. Follow steps 5 to 6 of the previous section to complete installation.

2.8.4 Uninstalling a hard disk drive

In the future, you may have to upgrade or replace a defective hard disk drive.

To uninstall the hard disk drive:

1. Press the HDD screw lock (A), then push the drive out from the bay (B) until the drive screws are released from the screw rails.
2. Slightly lift the HDD, then remove all plugs at the back of the drive.
3. Install a new HDD following the instructions in the previous section.

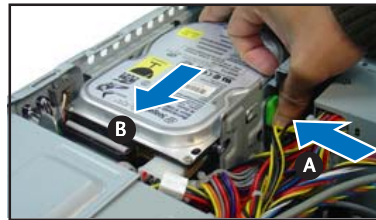

2.9 Replacing the covers

After you install all the necessary components to the system, replace the covers following the instructions in this section.

2.9.1 Replacing the front panel assembly

If you installed an optical drive, you must remove the optical drive bay cover before you replace the front panel assembly.

To remove the optical drive bay cover:

1. Locate the optical drive bay cover hook locks at the back of the front panel assembly.

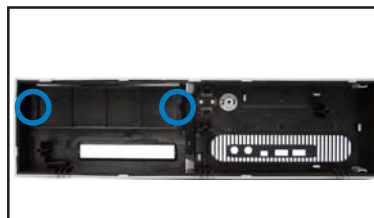

2. Press one lock inward (A), then push the optical drive bay cover from the outside of the front panel assembly (B) to release.

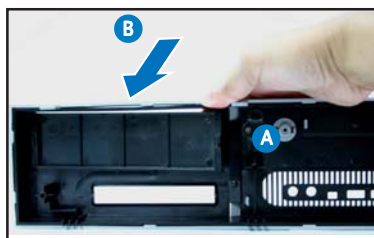

The photo on the right shows the front panel assembly without the optical drive bay cover.



To replace the front panel assembly:

1. Hook the hinge-like tabs to the holes on the right side of the chassis.

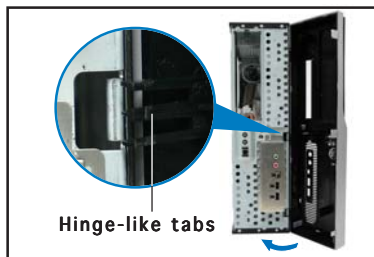

2. Swing the left edge of the front panel inward, then attach the front panel assembly hooks to the chassis until they snap in place.



Do not use too much force when replacing the front panel assembly.



2.9.2 Replacing the system cover

To replace the metal chassis support:

1. Reinstall the metal chassis support and the expansion card lock.
2. Match and insert the hooks of the cover to the elongated holes on the side of the chassis. All eight hooks (four hooks on both sides) of the cover must properly fit the designated holes.
3. Slide the cover to the direction of the front panel until it fits in place.
4. Replace the cover screws.

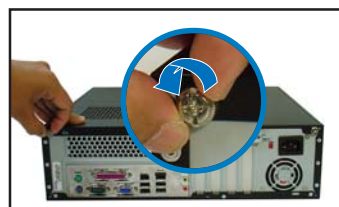
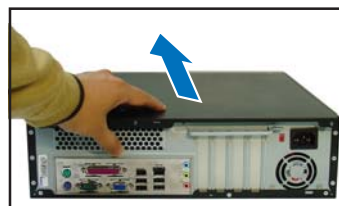

2.10 Installing the foot stands

You need to install the foot stands to place the system vertically on your desktop.

To install the foot stands:

1. Lay the system on its side on a flat, stable, and elevated surface, then locate two screw holes on the left side of the system.
2. Extend the left side of the system at least 3 cm from the edge of surface to facilitate installation.
3. Position the foot stand on the chassis side until their screw holes align.
4. Drive in a screw to secure the footstand to the chassis.
5. Repeat steps 3 to 4 to install the second foot stand.



The photo on the right shows the system in a vertical desktop placement.



2.11 Selecting the voltage

The system's power supply unit has a 115 V/230 V voltage selector switch located beside the power connector. Use this switch to select the appropriate system input voltage according to the voltage supply in your area.

If the voltage supply in your area is 100-127 V, set the switch to 115 V.

If the voltage supply in your area is 200-240 V, set the switch to 230 V.

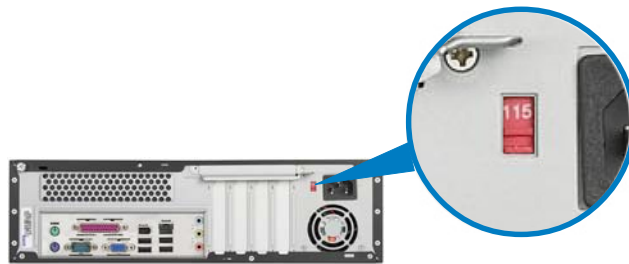

Setting the switch to 115 V in a 230 V environment will seriously damage the system!

2.12 Connecting external devices

To the front panel



To the rear panel

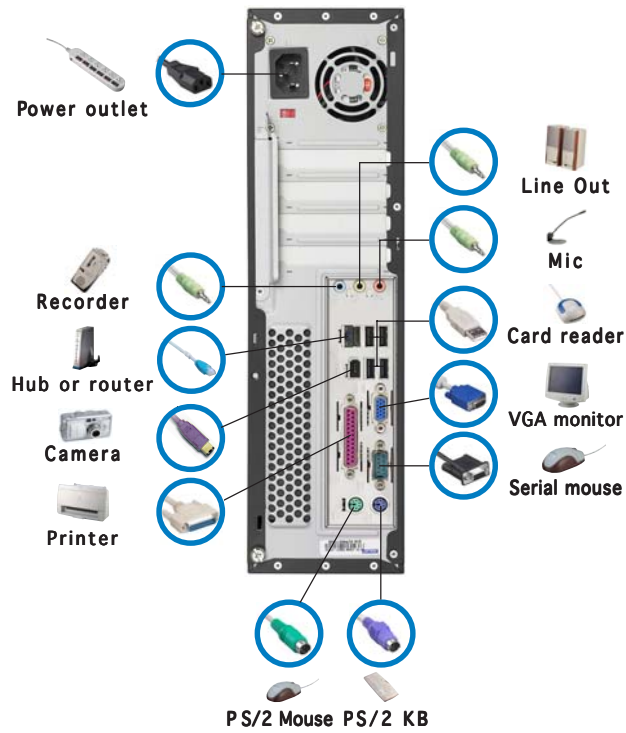

Chapter 3

This chapter helps you power up the system and install drivers and utilities from the support CD.



ASUS Pundit-PE3

Getting started

3.1 Installing an operating system

This system supports Windows® 2000/XP operating systems (OS). Always install the latest OS version and corresponding updates to maximize the features of your system.



- Motherboard settings and hardware options vary. Use the setup procedures presented in this chapter for reference only. Refer to your OS documentation for detailed information.
- Make sure that you install Windows® 2000 Service Pack 4 or the Windows® XP Service Pack 1 or later versions before installing the drivers for better compatibility and system stability.

3.2 Support CD information

The support CD that came with the system package contains the drivers, software applications, and utilities that you can install to avail all system features.



The contents of the support CD are subject to change at any time without notice. Visit the ASUS website(www.asus.com) for updates.

3.2.1 Running the support CD

Place the support CD to the optical drive. The CD automatically displays the **Drivers** menu if Autorun is enabled in your computer.

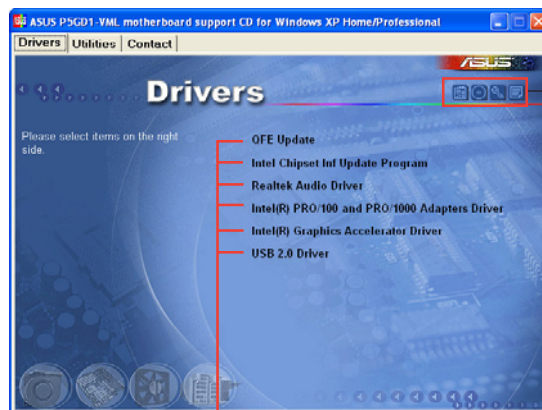

Click an icon to display support CD/motherboard information

Click an item to install



If **Autorun** is NOT enabled in your computer, browse the contents of the support CD to locate the file **ASSETUP.EXE** from the BIN folder. Double-click the **ASSETUP.EXE** to run the CD.

3.2.2 Drivers menu

The drivers menu shows the available device drivers if the system detects installed devices. Install the necessary drivers to activate the devices.



QFE Update

Installs the Quick Fix Engineering (QFE) driver updates.

Intel Chipset Inf Update Program

Installs the Intel® Chipset INF Update Program. This driver enables Plug-n-Play INF support for the Intel® chipset components on the motherboard. When installed to the target system, this driver provides the method for configuring the chipset components.

You can install this utility using three different modes: interactive, silent, or unattended preload. Installing the driver in interactive mode requires user input during installation. User input is not required when installing the driver in silent or unattended preload modes. Refer to the online help or readme file that came with the utility for details.

Realtek Audio Driver

Executes the wizard to install the Realtek® ALC655 audio driver and application.

Intel(R) PRO/100 and PRO/1000 Adapters Driver

Installs the Intel® PRO/100 and 10/100 Adapters Driver.

Intel(R) Graphics Accelerator Driver

Installs the Intel® Graphics Accelerator Driver.

USB 2.0 Driver

Installs the USB 2.0 driver.



The screen display and drivers option may not be the same for different operating system versions.

3.2.3 Utilities menu

The Utilities menu shows the applications and other software that the motherboard supports.

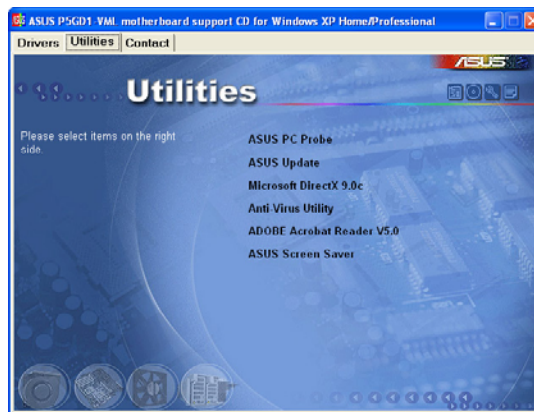

ASUS PC Probe

This smart utility monitors the fan speed, CPU temperature, and system voltages, and alerts you of any detected problems. This utility helps you keep your computer in healthy operating condition.

ASUS Update

The ASUS Update utility allows you to update the motherboard BIOS in a Windows® environment. This utility requires an Internet connection either through a network or an Internet Service Provider (ISP). See page 5-3 for details.

Microsoft DirectX 9.0c

Installs the Microsoft® DirectX 9.0c driver.

Anti-Virus Utility

The anti-virus application scans, identifies, and removes computer viruses. View the online help for detailed information.

ADOBE Acrobat Reader

Installs the Adobe® Acrobat® Reader V5.0.

ASUS Screen Saver

Installs the ASUS screen saver.



The screen display and utilities option may not be the same for different operating system versions.

3.2.4 ASUS contact information

Click the **Contact** tab to display the ASUS contact information. You can also find this information on the inside front cover of this user guide.



3.2.5 Other information

The icons on the top right corner of the screen give additional information on the motherboard and the contents of the support CD. Click an icon to display the specified information.

Motherboard Info

Displays the general specifications of the motherboard.

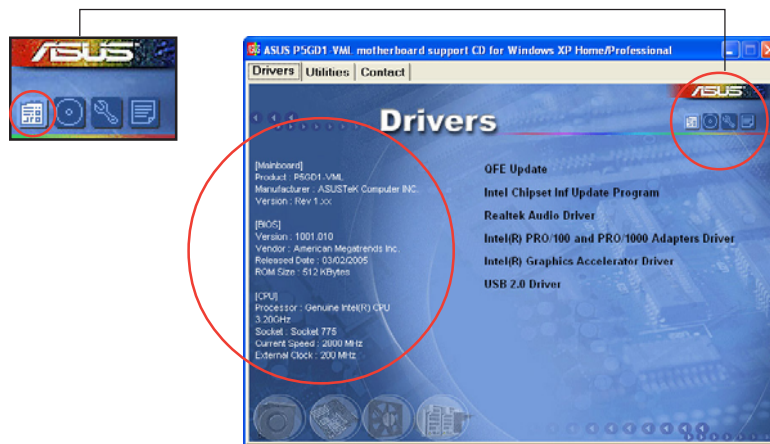

Browse this CD

Displays the support CD contents in graphical format.

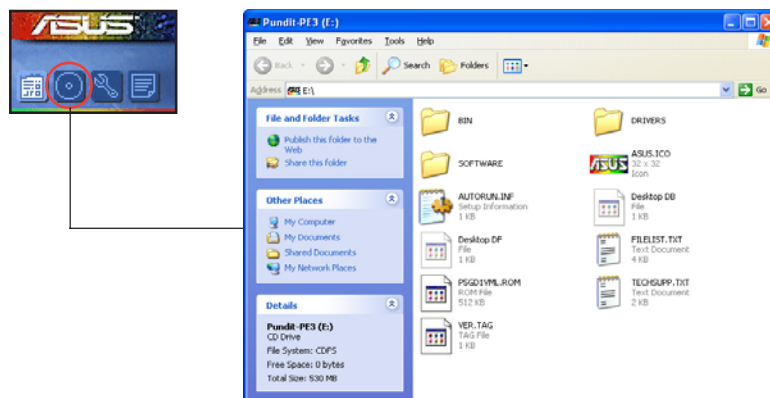

Technical support form

Displays the ASUS Technical Support Request Form that you have to fill out when requesting technical support.

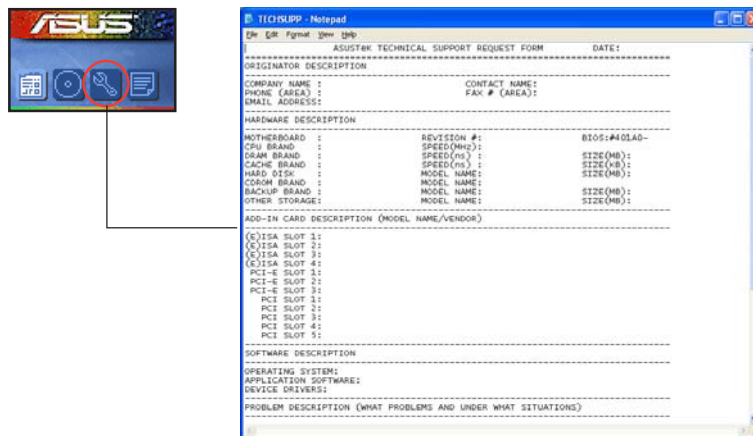

Filelist

Displays the contents of the support CD and a brief description of each in text format.

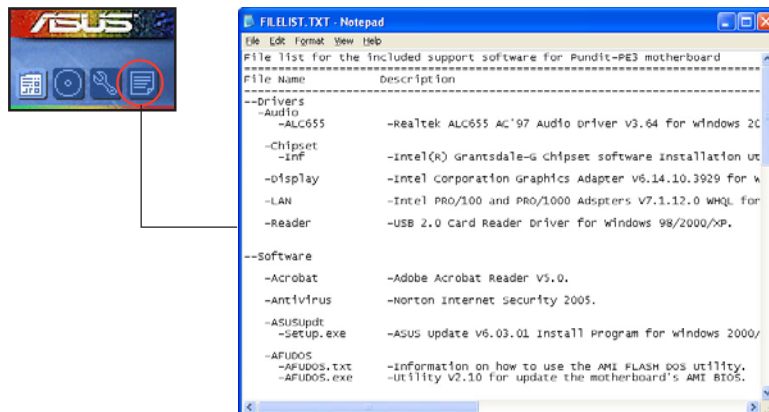



A series of 22 horizontal lines spaced evenly down the page, intended for handwritten notes.



Chapter 4

This chapter gives information about the motherboard that comes with the system. This chapter includes the motherboard layout, jumper settings, and connector locations.



ASUS Pundit-PE3

Motherboard info

4.1 Motherboard overview

Motherboard layout

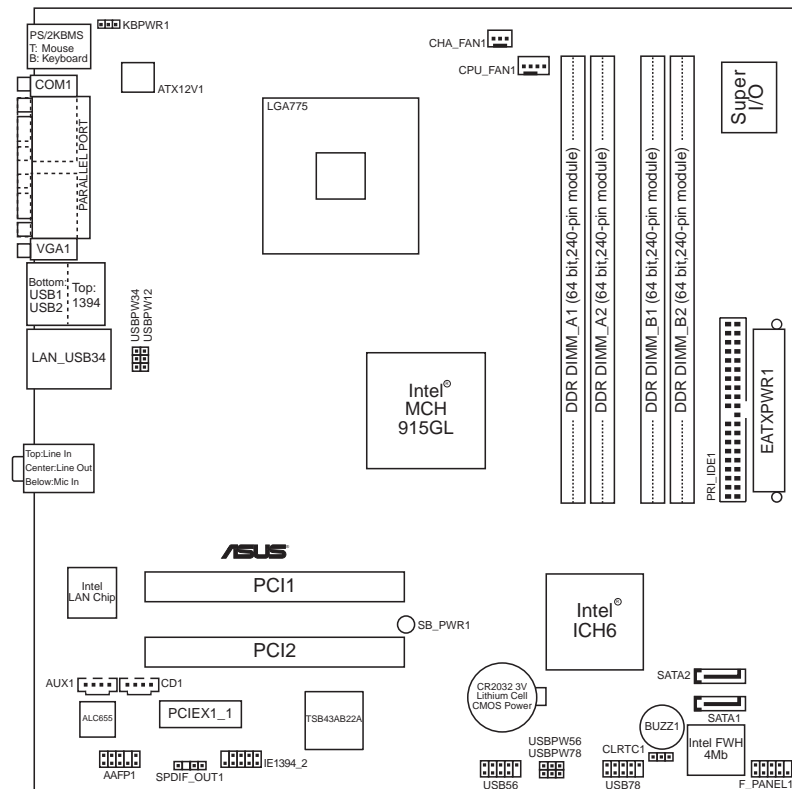

4.2 Jumpers

1. Clear RTC RAM (CLRRTC1)

This jumper allows you to clear the Real Time Clock (RTC) RAM in CMOS. You can clear the CMOS memory of date, time, and system setup parameters by erasing the CMOS RTC RAM data. The onboard button cell battery powers the RAM data in CMOS, which include system setup information such as system passwords.

To erase the RTC RAM:

1. Turn OFF the computer and unplug the power cord.
2. Remove the onboard battery.
3. Move the jumper cap from pins 1-2 (default) to pins 2-3. Keep the cap on pins 2-3 for about 5~10 seconds, then move the cap back to pins 1-2.
4. Reinstall the battery.
5. Plug the power cord and turn ON the computer.
6. Hold down the key during the boot process and enter BIOS setup to re-enter data.



Except when clearing the RTC RAM, never remove the cap on CLRRTC1 jumper default position. Removing the cap will cause system boot failure!

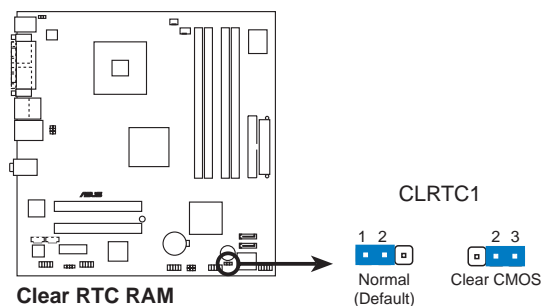

2. USB device wake-up (3-pin USBPW12, USBPW34, USBPW56, USBPW78)

Set these jumpers to +5V to wake up the computer from S1 sleep mode (CPU stopped, DRAM refreshed, system running in low power mode) using the connected USB devices. Set to +5VSB to wake up from S3 and S4 sleep modes (no power to CPU, DRAM in slow refresh, power supply in reduced power mode).

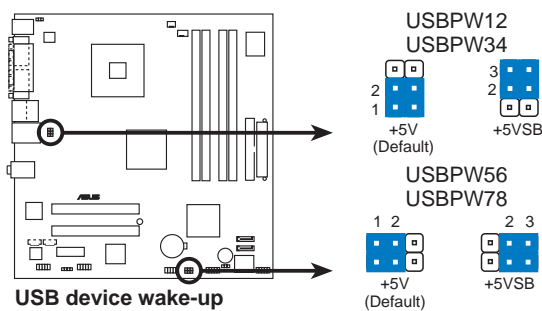

- The USB device wake-up feature requires a power supply that can provide 500mA on the +5VSB lead for each USB port; otherwise, the system will not power up.
- The total current consumed must NOT exceed the power supply capability (+5VSB) whether under normal condition or in sleep mode.

3. Keyboard power (3-pin KBPWR1)

This jumper allows you to enable or disable the keyboard wake-up feature. Default setting is 2-3. Set this jumper to pins 1-2 (+5V) if you do not want to wake up the computer when you press a key on the keyboard. This feature requires an ATX power supply that can supply at least 1A on the +5VSB lead, and a corresponding setting in the BIOS.

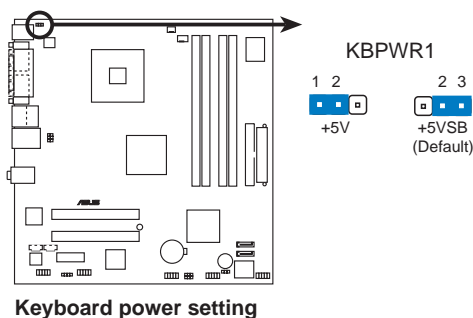

4.3 Connectors

4.3.1 Rear panel connectors

Refer to section “1.3 Rear panel” for a description of the rear panel I/O ports.

4.3.2 Internal connectors

1. Primary IDE connector (40-pin PRI_IDE1)

This connector is for an Ultra DMA 100/66/33 signal cable. The Ultra DMA 100/66/33 signal cable has three connectors: a blue connector for the primary IDE connector on the motherboard, a black connector for an Ultra DMA 100/66/33 IDE slave device (optical drive/hard disk drive), and a gray connector for an Ultra DMA 100/66/33 IDE master device (hard disk drive). If you install an optical drive and an IDE HDD, you must configure the optical drive as a slave device by setting its jumper accordingly. Refer to the optical drive or HDD documentation for the jumper settings.



- Pin 20 on the IDE connector is removed to match the covered hole on the Ultra DMA cable connector. This prevents incorrect insertion when you connect the IDE cable.
- Use the 80-conductor IDE cable for Ultra DMA 100/66/33 IDE devices.

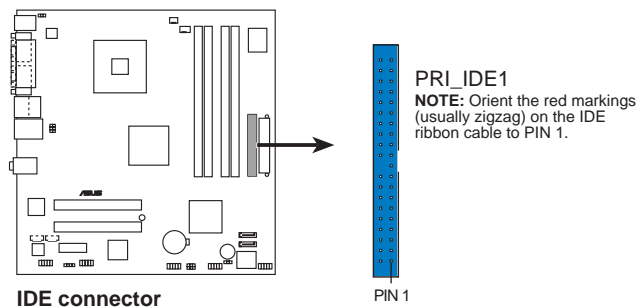

2. Serial ATA connectors (7-pin SATA1, SATA2)

These connectors are for the Serial ATA signal cables for Serial ATA hard disk drives.

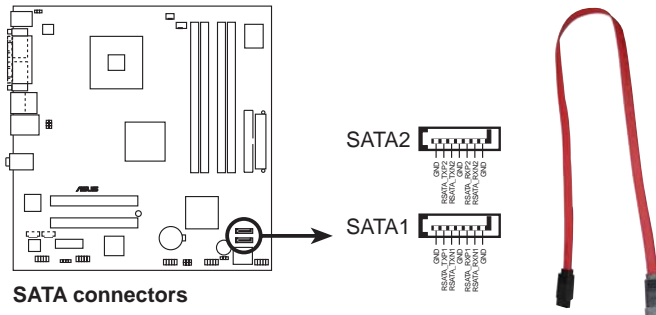

SATA connectors



Important notes on Serial ATA

- You must install Windows® 2000 Service Pack 4 or the Windows® XP Service Pack1 before using Serial ATA hard disk drives.
- When using the connectors in standard IDE mode, you can connect the primary (boot) hard disk drive to any of the SATA connectors.

3. CPU and Chassis fan connectors (4-pin CPU_FAN1, 3-pin CHA_FAN1)

The fan connectors support cooling fans of 350 mA~740 mA (8.88 W max.) or a total of 1 A~2.22 A (26.64 W max.) at +12V. Connect the fan cables to the fan connectors on the motherboard, making sure that the black wire of each cable matches the ground pin of the connector.



Do not forget to connect the fan cables to the fan connectors. Insufficient air flow inside the system may damage the motherboard components. These are not jumpers! Do not place jumper caps on the fan connectors!

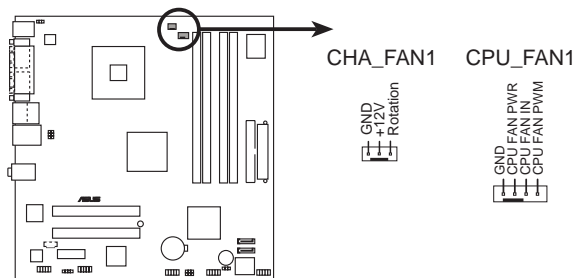

Fan connectors

4. USB connectors (10-1 pin USB56, USB78)

These connectors are for USB 2.0 ports. Connect the USB/GAME module cable to any of these connectors, then install the module to a slot opening at the back of the system chassis. These USB connectors comply with USB 2.0 specification that supports up to 480 Mbps connection speed.

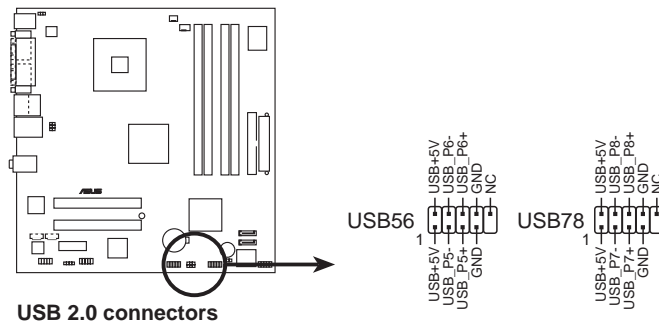

Pin 20 on the IDE connector is removed to match the covered hole on the Ultra DMA cable connector. This prevents incorrect insertion when you connect the IDE cable.



Never connect a 1394 cable to the USB connectors. Doing so will damage the motherboard!

5. Internal audio connectors (4-pin CD1, AUX1)

These connectors allow you to receive stereo audio input from audio sources such as an optical drive, TV tuner, or MPEG card.

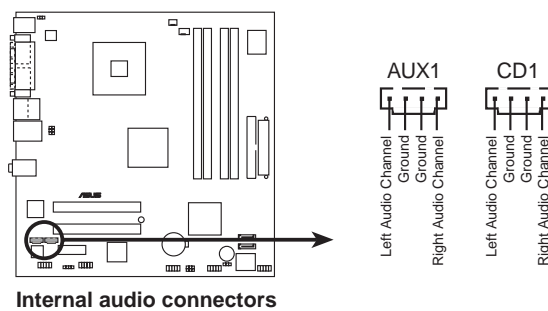

6. ATX power connectors (24-pin EATXPWR1, 4-pin ATX12V1)

These connectors are for ATX power supply plugs. The plugs from the power supply are pre-connected to these connectors. If you have disconnected them during installation, find the proper orientation and push down the plugs firmly to the connectors until they fit.

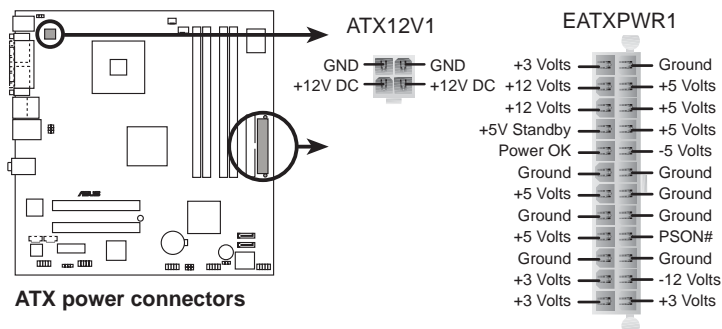

Important notes on the motherboard power requirements



- Do not forget to connect the 4-pin ATX +12 V power plug; otherwise, the system will not boot up.
- The system comes with a proprietary ATX 12 V Specification 2.0 power supply unit (PSU) with a minimum 275 W power rating.

7. Front panel audio connector (10-1 pin AAFP1)

This connector supports the front panel audio I/O ports with the legacy AC'97 audio standard.

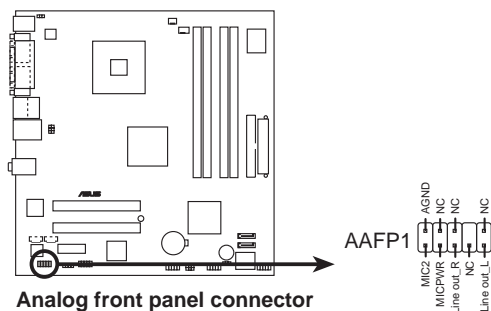

8. Digital audio connector (4-1 pin SPDIF_OUT1)

This connector supports the Line Out / S/PDIF Out port in the system front panel.

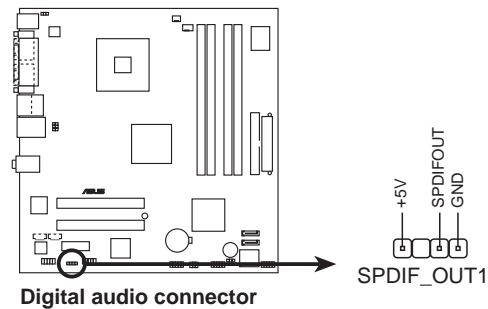

9. IEEE 1394a port connector (10-1 pin IE1394_2 [orange])

This connector supports the 4-pin IEEE 1394 port in the system front panel.

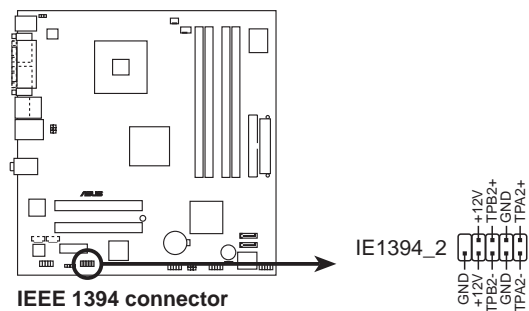

Never connect a **USB cable** to the IEEE 1394 connector. Doing so will damage the motherboard!

10. System panel connector (10-1 pin F_PANEL1)

This connector supports several chassis-mounted functions.

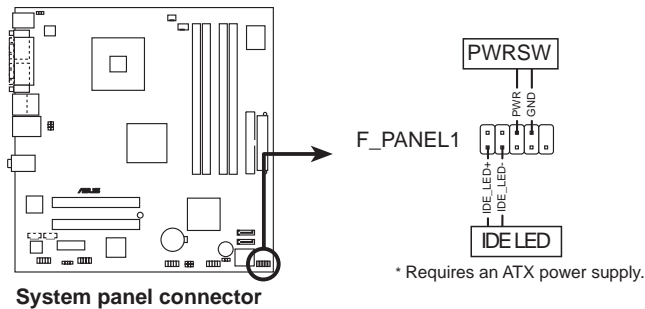

The system panel connector is color-coded for easy connection. Refer to the connector description below for details.

- **Hard disk drive activity LED (Red 2-pin IDELED)**
This 2-pin connector is for the HDD Activity LED. Connect the HDD Activity LED cable to this connector. The IDE LED lights up or flashes when data is read from or written to the HDD.
- **ATX power button/soft-off button (Yellow 2-pin PWRSW)**
This connector is for the system power button. Pressing the power button turns the system on or puts the system in sleep or soft-off mode depending on the BIOS settings. Pressing the power switch for more than four seconds while the system is ON turns the system OFF.

Chapter 5

This chapter tells how to change system settings through the BIOS Setup menus and describes the BIOS parameters.



ASUS Pundit-PE3

BIOS setup

5.1 Managing and updating your BIOS

The following utilities allow you to manage and update the motherboard Basic Input/Output System (BIOS) setup.

1. **ASUS CrashFree BIOS 2** (Updates the BIOS using the motherboard support CD when the BIOS file fails or gets corrupted.)
2. **ASUS Update** (Updates the BIOS in Windows® environment.)

Refer to the corresponding sections for details on these utilities.



Save a copy of the original motherboard BIOS file from the support CD to a USB floppy disk or flash disk in case you need to restore the BIOS in the future. You can copy the original motherboard BIOS using the ASUS Update or AFUDOS utilities.

5.1.1 ASUS CrashFree BIOS 2 utility

The ASUS CrashFree BIOS 2 is an auto recovery tool that allows you to restore the BIOS file when it fails or gets corrupted during the updating process. You can update a corrupted BIOS file using the motherboard support CD that contains the original or updated BIOS file.



Prepare the motherboard support CD containing the original or updated motherboard BIOS before using this utility.

Recovering the BIOS

To recover the BIOS:

1. Remove any floppy disk from the floppy disk drive, then turn on the system.
2. Insert the support CD to the optical drive.
3. The utility displays the following message and automatically checks the floppy disk for the original or updated BIOS file.

```
Bad BIOS checksum. Starting BIOS recovery...
Checking for floppy...
```

When no floppy disk is found, the utility automatically checks the optical drive for the original or updated BIOS file. The utility then updates the corrupted BIOS file.

```
Bad BIOS checksum. Starting BIOS recovery...
Checking for floppy...
Floppy not found!
Checking for CD-ROM...
CD-ROM found!
Reading file "P5GD1VML.ROM". Completed.
Start flashing...
```



DO NOT shut down or reset the system while updating the BIOS! Doing so can cause system boot failure!

- Restart the system after the utility recovers or updates the BIOS file.



The recovered BIOS may not be the latest BIOS version for this motherboard. Visit the ASUS website (www.asus.com) to download the latest BIOS file.

5.1.2 ASUS Update utility

The ASUS Update is a utility that allows you to manage, save, and update the motherboard BIOS in Windows® environment. The ASUS Update utility allows you to:

- Save the current BIOS file
- Download the latest BIOS file from the Internet
- Update the BIOS from an updated BIOS file
- Update the BIOS directly from the Internet, and
- View the BIOS version information.

This utility is available in the support CD that came with the system package.



ASUS Update requires an Internet connection either through a network or an Internet Service Provider (ISP).

Installing ASUS Update

To install ASUS Update:

- Place the support CD in the optical drive. The **Drivers** menu appears.
- Click the **Utilities** tab, then click **ASUS Update**. See page 3-4 for the **Utilities** screen menu.
- The ASUS Update utility is copied to your system.



Quit all Windows® applications before you update the BIOS using this utility.

Updating the BIOS through the Internet

To update the BIOS through the Internet:

1. Launch the ASUS Update utility from the Windows® desktop by clicking **Start > Programs > ASUS > ASUSUpdate > ASUSUpdate**. The ASUS Update main window appears.

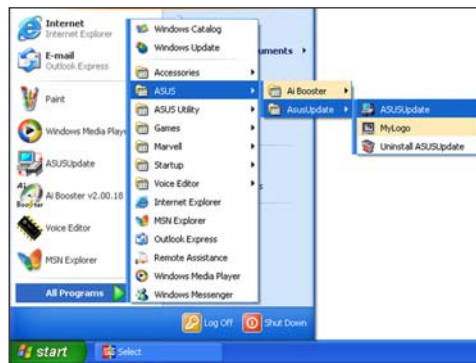

2. Select **Update BIOS from the Internet** option from the drop-down menu, then click **Next**.
3. Select the ASUS FTP site nearest you to avoid network traffic, or click **Auto Select**. Click **Next**.

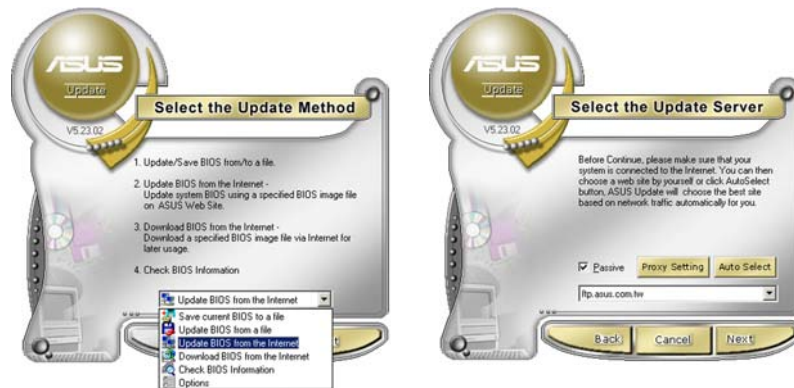

4. From the FTP site, select the BIOS version that you wish to download. Click **Next**.
5. Follow the screen instructions to complete the update process.



The ASUS Update utility is capable of updating itself through the Internet. Always update the utility to avail all its features.



Updating the BIOS through a BIOS file

To update the BIOS through a BIOS file:

1. Launch the ASUS Update utility from the Windows® desktop by clicking **Start > Programs > ASUS > ASUSUpdate > ASUSUpdate**. The ASUS Update main window appears.
2. Select **Update BIOS from a file** option from the drop-down menu, then click **Next**.

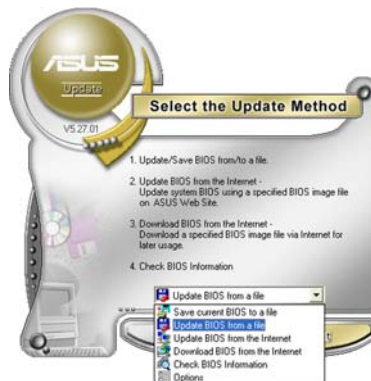

3. Locate the BIOS file from the **Open** window, then click **Save**.
4. Follow the screen instructions to complete the update process.

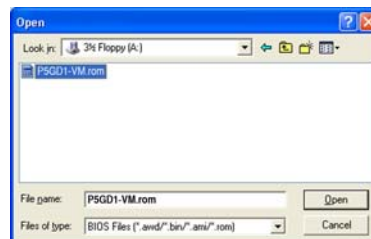

5.2 BIOS setup program

This motherboard supports a programmable firmware chip that you can update using the provided utility described in section “5.1 Managing and updating your BIOS.”

Use the BIOS Setup program when you are installing a motherboard, reconfiguring your system, or prompted to “Run Setup.” This section explains how to configure your system using this utility.

Even if you are not prompted to use the Setup program, you can change the configuration of your computer in the future. For example, you can enable the security password feature or change the power management settings. This requires you to reconfigure your system using the BIOS Setup program so that the computer can recognize these changes and record them in the CMOS RAM of the firmware hub.

The firmware hub on the motherboard stores the Setup utility. When you start up the computer, the system provides you with the opportunity to run this program. Press during the Power-On-Self-Test (POST) to enter the Setup utility; otherwise, POST continues with its test routines.

If you wish to enter Setup after POST, restart the system by pressing <Ctrl+Alt+Delete>, or by pressing the reset button on the system chassis. You can also restart by turning the system off and then back on. Do this last option only if the first two failed.

The Setup program is designed to make it as easy to use as possible. Being a menu-driven program, it lets you scroll through the various sub-menus and make your selections from the available options using the navigation keys.



- The default BIOS settings for this motherboard apply for most conditions to ensure optimum performance. If the system becomes unstable after changing any BIOS settings, load the default settings to ensure system compatibility and stability. Select the **Load Default Settings** item under the Exit Menu. See section “5.7 Exit Menu.”
- The BIOS setup screens shown in this section are for reference purposes only, and may not exactly match what you see on your screen.
- Visit the ASUS website (www.asus.com) to download the latest BIOS file for this motherboard.

5.2.1 BIOS menu screen

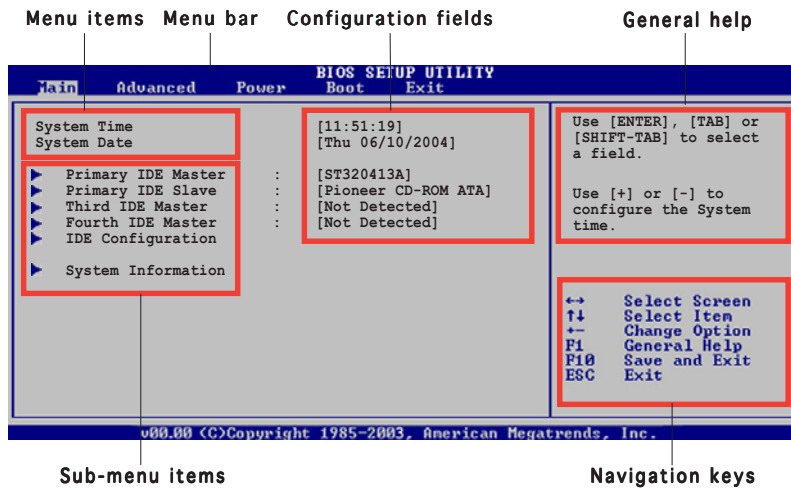

5.2.2 Menu bar

The menu bar on top of the screen has the following main items:

- Main** For changing the basic system configuration
- Advanced** For changing the advanced system settings
- Power** For changing the advanced power management (APM) configuration
- Boot** For changing the system boot configuration
- Exit** For selecting the exit options and loading default settings

To select an item on the menu bar, press the right or left arrow key on the keyboard until the desired item is highlighted.

5.2.3 Navigation keys

At the bottom right corner of a menu screen are the navigation keys for that particular menu. Use the navigation keys to select items in the menu and change the settings.



Some of the navigation keys differ from one screen to another.

5.2.4 Menu items

The highlighted item on the menu bar displays the specific items for that menu. For example, selecting **Main** shows the Main menu items.

The other items (Advanced, Power, Boot, and Exit) on the menu bar have their respective menu items.

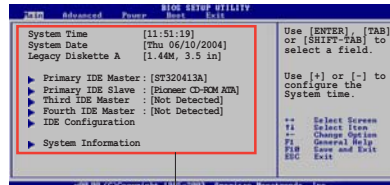

Main menu items

5.2.5 Sub-menu items

A solid triangle before each item on any menu screen means that the item has a sub-menu. To display the sub-menu, select the item and press <Enter>.

5.2.6 Configuration fields

These fields show the values for the menu items. If an item is user-configurable, you can change the value of the field opposite the item. You cannot select an item that is not user-configurable.

A configurable field is enclosed in brackets, and is highlighted when selected. To change the value of a field, select it then press <Enter> to display a list of options. Refer to “5.2.7 Pop-up window.”

5.2.7 Pop-up window

Select a menu item then press <Enter> to display a pop-up window with the configuration options for that item.

5.2.8 Scroll bar

A scroll bar appears on the right side of a menu screen when there are items that do not fit on the screen. Press the Up/Down arrow keys or <Page Up> / <Page Down> keys to display the other items on the screen.

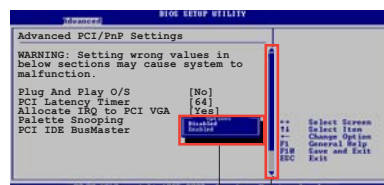

Pop-up window

Scroll bar

5.2.9 General help

At the top right corner of the menu screen is a brief description of the selected item.

5.3 Main menu

When you enter the BIOS Setup program, the Main menu screen appears, giving you an overview of the basic system information.



Refer to section “5.2.1 BIOS menu screen” for information on the menu screen items and how to navigate through them.

```
BIOS SETUP UTILITY
Main  Advanced  Power  Boot  Exit
-----
System Time          [11:51:19]
System Date          [Thu 06/10/2004]
Use [ENTER], [TAB] or
[SHIFT-TAB] to select a
field.

▶ Primary IDE Master : [ST320413A]
▶ Primary IDE Slave  : [Pioneer CD-ROM ATA]
▶ Third IDE Master   : [Not Detected]
▶ Fourth IDE Master  : [Not Detected]
▶ IDE Configuration

▶ System Information

Use [+] or [-] to
configure the System
time.

↔ Select Screen
↑↓ Select Item
+- Change Option
F1 General Help
F10 Save and Exit
ESC Exit

v00.00 (C)Copyright 1985-2003, American Megatrends, Inc.
```

5.3.1 System Time [xx:xx:xx]

Allows you to set the system time.

5.3.2 System Date [Day xx/xx/xxxx]

Allows you to set the system date.

5.3.3 Primary, Third, and Fourth IDE Master/Slave

While entering Setup, the BIOS automatically detects the presence of IDE devices. There is a separate sub-menu for each IDE device. Select a device item, then press <Enter> to display the IDE device information.

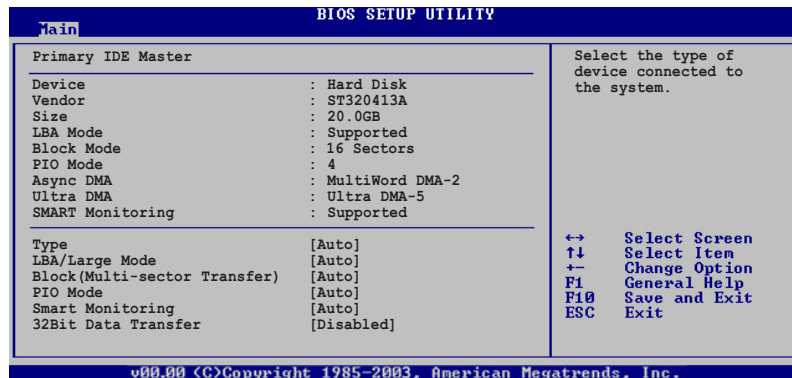

The BIOS automatically detects the values opposite the dimmed items (Device, Vendor, Size, LBA Mode, Block Mode, PIO Mode, Async DMA, Ultra DMA, and SMART monitoring). These values are not user-configurable. These items show N/A if no IDE device is installed in the system.

Type [Auto]

Selects the type of IDE drive. Setting to Auto allows automatic selection of the appropriate IDE device type. Select CDROM if you are specifically configuring a CD-ROM drive. Select ARMD (ATAPI Removable Media Device) if your device is either a ZIP, LS-120, or MO drive.

Configuration options: [Not Installed] [Auto] [CDROM] [ARMD]

LBA/Large Mode [Auto]

Enables or disables the LBA mode. Setting to Auto enables the LBA mode if the device supports this mode, and if the device was not previously formatted with LBA mode disabled. Configuration options: [Disabled] [Auto]

Block (Multi-sector Transfer) [Auto]

Enables or disables data multi-sectors transfers. When set to Auto, the data transfer from and to the device occurs multiple sectors at a time if the device supports multi-sector transfer feature. When set to [Disabled], the data transfer from and to the device occurs one sector at a time.

Configuration options: [Disabled] [Auto]

PIO Mode [4]

Selects the PIO mode.
Configuration options: [Auto] [0] [1] [2] [3] [4]

DMA Mode [Auto]

Selects the DMA mode. Configuration options: [Auto] [SWDMA0]
[SWDMA1] [SWDMA2] [MWDMA0] [MWDMA1] [MWDMA2] [UDMA0]
[UDMA1] [UDMA2] [UDMA3] [UDMA4] [UDMA5]

SMART Monitoring [Auto]

Sets the Smart Monitoring, Analysis, and Reporting Technology.
Configuration options: [Auto] [Disabled] [Enabled]

32Bit Data Transfer [Disabled]

Enables or disables 32-bit data transfer.
Configuration options: [Disabled] [Enabled]

5.3.4 IDE Configuration

The items in this menu allow you to set or change the configurations for the IDE devices installed in the system. Select an item then press <Enter> if you want to configure the item.

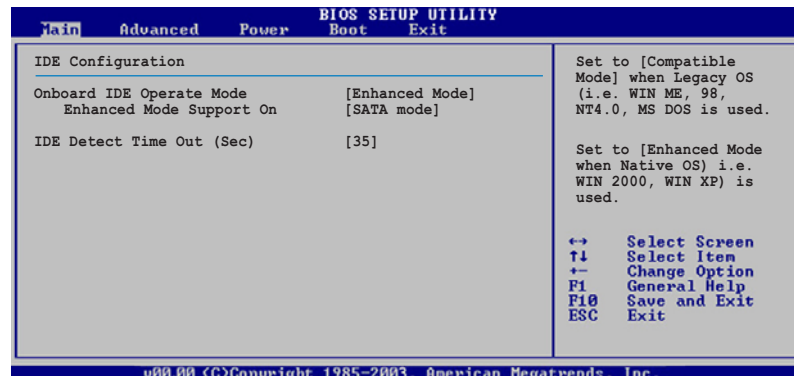

Onboard IDE Operate Mode [Enhanced Mode]

Allows selection of the IDE operation mode depending on the operating system (OS) that you installed. Set to Enhanced Mode if you are using native OS, such as Windows® 2000/XP. Configuration options: [Disabled] [Compatible Mode] [Enhanced Mode]

Enhanced Mode Support On [SATA mode]

The default setting SATA allows you to use native OS on Serial ATA and Parallel ATA ports. We recommend that you do not change the default setting for better OS compatibility. In this setting, you may use legacy OS on the Parallel ATA ports **only if** you did not install any Serial ATA device.

The P-ATA+S-ATA and P-ATA options are for advanced users only. If you set to any of these options and encounter problems, revert to the default setting **SATA**. Configuration options: [S-ATA+P-ATA] [SATA mode] [P-ATA]

IDE Detect Time Out [35]

Selects the time out value for detecting ATA/ATAPI devices.
Configuration options: [0] [5] [10] [15] [20] [25] [30] [35]

5.3.5 System Information

This menu gives you an overview of the general system specifications. The BIOS automatically detects the items in this menu.

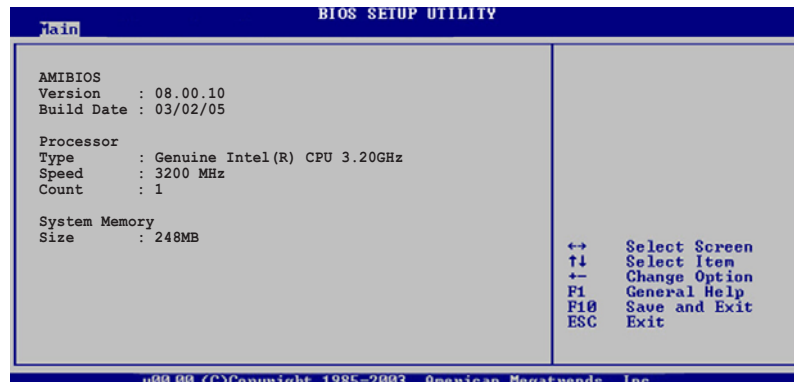

AMI BIOS

Displays the auto-detected BIOS information.

Processor

Displays the auto-detected CPU specification.

System Memory

Displays the auto-detected system memory.

5.4 Advanced menu

The Advanced menu items allow you to change the settings for the CPU and other system devices.



Take caution when changing the settings of the Advanced menu items. Incorrect field values can cause the system to malfunction.

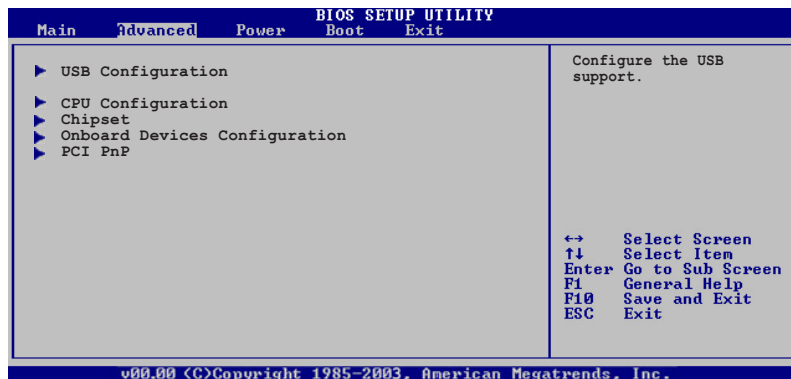

5.4.1 USB Configuration

The items in this menu allows you to change the USB-related features. Select an item then press <Enter> to display the configuration options.

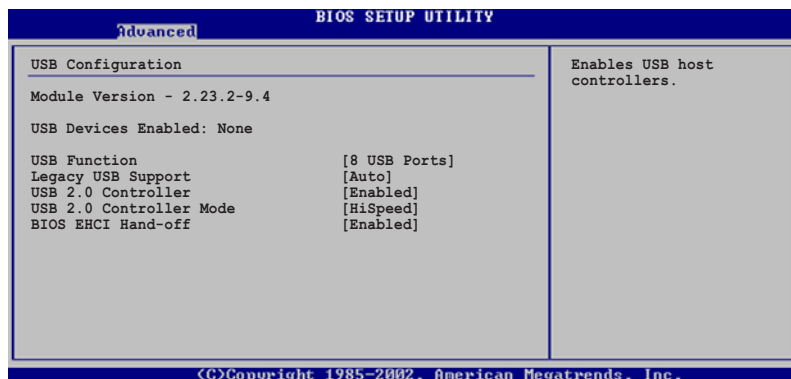

USB Function [8 USB Ports]

Allows you to enable or disable support for the USB ports and 6-in-1 card reader. Configuration options: [Disabled] [2 USB Ports] [4 USB Ports] [6 USB Ports] [8 USB Ports]

Legacy USB Support [Auto]

Allows you to enable or disable support for USB devices on legacy operating systems (OS). Setting to [Auto] allows the system to detect the presence of USB devices at startup. If detected, the USB controller legacy mode is enabled. If no USB device is detected, the legacy USB support is disabled. Configuration options: [Disabled] [Enabled] [Auto]

USB 2.0 Controller [Enabled]

Allows you to enable or disable the USB 2.0 controller. Configuration options: [Enabled] [Disabled]

USB 2.0 Controller Mode [HiSpeed]

Allows you to configure the USB 2.0 controller in HiSpeed (480 Mbps) or Full Speed (12 Mbps). Configuration options: [Full Speed] [HiSpeed]

BIOS EHCI Hand-Off [Disabled]

Allows you to enable support for operating systems without an EHCI hand-off feature. Configuration options: [Enabled] [Disabled]

5.4.2 CPU Configuration

The items in this menu show the CPU-related information that the BIOS automatically detects.

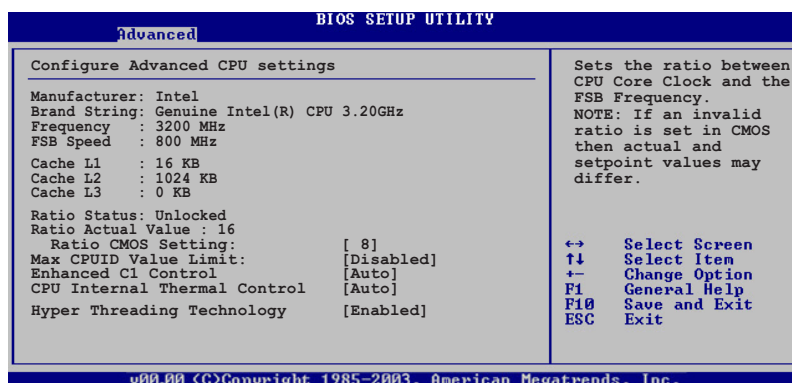

Ratio CMOS Setting [8]

Sets the ratio between the CPU Core Clock and the Front Side Bus frequency. The default value of this item is auto-detected by BIOS. Use the <+> or <-> keys to adjust the values.



Max CPUID Value Limit [Disabled]

Enable this item to boot legacy operating systems that cannot support CPUs with extended CPUID functions. Configuration options: [Disabled] [Enabled]

Enhanced C1 Control [Auto]

When set to [Auto], the BIOS will automatically check the CPU's capability to enable the C1E support. In C1E mode, the CPU power consumption is lower when idle. Configuration options: [Auto] [Disabled]

CPU Internal Thermal Control [Auto]

Disables or sets the CPU internal thermal control.
Configuration options: [Auto] [Disabled]

Hyper-Threading Technology [Enabled]

Allows you to enable or disable the processor Hyper-Threading Technology. Refer to the Appendix for more information on the Hyper-Threading Technology. Configuration options: [Disabled] [Enabled]

5.4.3 Advanced Chipset Settings

The Advanced Chipset Settings menu allows you to change the advanced chipset settings. Select an item then press <Enter> to display the sub-menu.

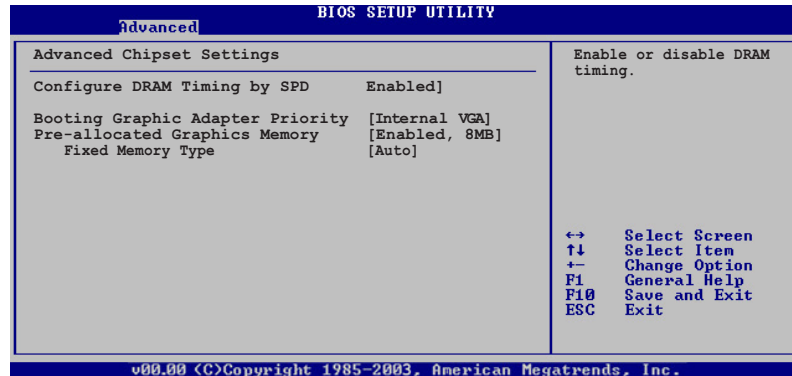

Configure DRAM Timing by SPD [Enabled]

When this item is enabled, the DRAM timing parameters are set according to the DRAM SPD (Serial Presence Detect). When disabled, you can manually set the DRAM timing parameters through the DRAM sub-items. The following sub-items appear when this item is Disabled. Configuration options: [Disabled] [Enabled]

DRAM CAS# Latency [3 Clocks]

Controls the latency between the SDRAM read command and the time the data actually becomes available.

Configuration options: [3 Clocks] [2.5 Clocks] [2 Clocks]

DRAM RAS# Precharge [4 Clocks]

Controls the idle clocks after issuing a precharge command to the DDR SDRAM. Configuration options: [2 Clocks] [3 Clocks] [4 Clocks] [5 Clocks]

DRAM RAS# to CAS# Delay [4 Clocks]

Controls the latency between the DDR SDRAM active command and the read/write command. Configuration options: [2 Clocks] [3 Clocks] [4 Clocks] [5 Clocks]

DRAM RAS# Activate to Precharge Delay [15 Clocks]

Configuration options: [4 Clocks] [5 Clocks] ~ [15 Clocks]

DRAM Burst Length [8]

Sets the DRAM Burst Length. Configuration options: [4] [8]

Booting Graphic Adapter Priority [PCI/PCI Express]

Allows selection of the graphics controller to use as primary boot device.
Configuration options: [Internal VGA] [PCI /Int-VGA]

Pre-allocated Graphics Memory [Enabled, 8MB]

Allows user to select the amount of system memory pre-allocated by the internal graphics device. Configuration options: [Disabled] [Enabled, 1MB] [Enabled, 4MB] [Enabled, 8MB] [Enabled, 16MB] [Enabled, 32MB]

Fixed Memory Type [Auto]

Allows you to set the type of fixed memory for the onboard VGA.
Configuration options: [Auto] [DVMT] [FIX] [DVMT+FIX]

5.4.4 Onboard Devices Configuration

Advanced		BIOS SETUP UTILITY	
Configure Win627EHF Super IO Chipset		Enable or disable AC97 controller.	
Onboard AC97 Controller	[Enabled]		
Onboard 1394 Controller	[Enabled]		
Onboard LAN	[Enabled]		
LAN Boot ROM	[Disabled]		
Serial Port1 Address	[3F8/IRQ4]		
Parallel Port Address	[378]		
Parallel Port Mode	[ECP]		
ECP Mode DMA Channel	[DMA3]		
Parallel Port IRQ	[IRQ7]		

©Copyright 1985-2002, American Megatrends, Inc.

Onboard AC97 Controller [Enabled]

Enables or disables the AC97 audio controller.
Configuration options: [Enabled] [Disabled]

Onboard 1394 Controller [Enabled]

Enables or disables the IEEE 1394 controller.
Configuration options: [Disabled] [Enabled]

OnBoard LAN [Enabled]

Enables or disables the onboard LAN controller.
Configuration options: [Disabled] [Enabled]

LAN Boot ROM [Disabled]

Allows you to enable or disable the LAN Boot ROM in the onboard LAN controller. This item appears only when the Onboard LAN item is set to Enabled. Configuration options: [Disabled] [Enabled]

Serial Port1 Address [3F8/IRQ4]

Allows you to select the Serial Port1 base address.

Configuration options: [Disabled] [3F8/IRQ4] [2F8/IRQ3] [3E8/IRQ4] [2E8/IRQ3]

Parallel Port Address [378]

Allows you to select the Parallel Port base addresses.

Configuration options: [Disabled] [378] [278] [3BC]

Parallel Port Mode [ECP]

Allows you to select the Parallel Port mode.

Configuration options: [Normal] [Bi-directional] [EPP] [ECP]

ECP Mode DMA Channel [DMA3]

Appears only when the Parallel Port Mode is set to [ECP]. This item allows you to set the Parallel Port ECP DMA.

Configuration options: [DMA0] [DMA1] [DMA3]

EPP Version [1.9]

Allows selection of the Parallel Port EPP version. This item appears only when the **Parallel Port Mode** is set to **EPP**.

Configuration options: [1.9] [1.7]

Parallel Port IRQ [IRQ7]

Allows selection of the Parallel Port IRQ.

Configuration options: [IRQ5] [IRQ7]

2.4.5 PCI PnP

The PCI PnP menu items allow you to change the advanced settings for PCI/PnP devices. The menu includes setting IRQ and DMA channel resources for either PCI/PnP or legacy ISA devices, and setting the memory size block for legacy ISA devices.



Take caution when changing the settings of the PCI PnP menu items. Incorrect field values can cause the system to malfunction.



Plug and Play O/S [No]

When set to [No], BIOS configures all the devices in the system. When set to [Yes] and if you install a Plug and Play operating system, the operating system configures the Plug and Play devices not required for boot. Configuration options: [No] [Yes]

PCI Latency Timer [64]

Allows you to select the value in units of PCI clocks for the PCI device latency timer register. Configuration options: [32] [64] [96] [128] [160] [192] [224] [248]

Allocate IRQ to PCI VGA [Yes]

When set to [Yes], BIOS assigns an IRQ to PCI VGA card if the card requests for an IRQ. When set to [No], BIOS does not assign an IRQ to the PCI VGA card even if requested. Configuration options: [No] [Yes]

Palette Snooping [Disabled]

When set to [Enabled], the palette snooping feature informs the PCI devices that an ISA graphics device is installed in the system so that the latter can function correctly. Configuration options: [Disabled] [Enabled]

IRQ-xx assigned to [PCI Device]

When set to [PCI Device], the specific IRQ is free for use of PCI/PnP devices. When set to [Reserved], the IRQ is reserved for legacy ISA devices. Configuration options: [PCI Device] [Reserved]

5.5 Power menu

The Power menu items allow you to change the settings for the Advanced Power Management (APM) and Advanced Configuration and Power Interface (ACPI). Select an item then press <Enter> to display the configuration options.

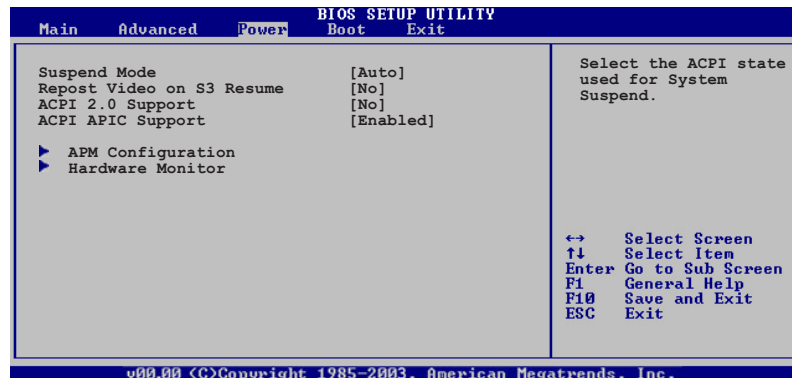

5.5.1 Suspend Mode [Auto]

Allows you to select the Advanced Configuration and Power Interface (ACPI) state to be used for system suspend.

Configuration options: [S1 (POS) Only] [S3 Only] [Auto]

5.5.2 Repost Video on S3 Resume [No]

Determines whether to invoke VGA BIOS post on S3/STR resume.

Configuration options: [No] [Yes]

5.5.3 ACPI 2.0 Support [No]

Allows you to add more tables for Advanced Configuration and Power Interface (ACPI) 2.0 specifications. Configuration options: [No] [Yes]

5.5.4 ACPI APIC Support [Enabled]

Allows you to enable or disable the Advanced Programmable Interrupt Controller (APIC) mode under Advanced Configuration and Power Interface (ACPI). When set to Enabled, the ACPI APIC table pointer is included in the RSDT pointer list. Configuration options: [Disabled] [Enabled]

5.5.5 APM Configuration

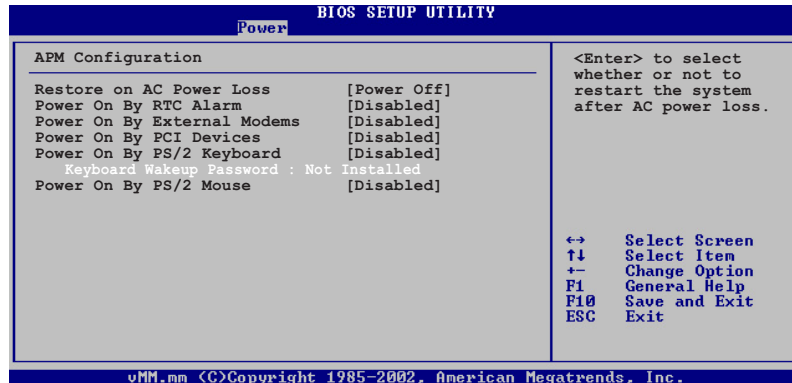

Restore on AC Power Loss [Power Off]

When set to Power Off, the system goes into off state after an AC power loss. When set to Power On, the system goes on after an AC power loss. When set to Last State, the system goes into either off or on state, whatever the system state was before the AC power loss.
Configuration options: [Power Off] [Power On] [Last State]

Power On By RTC Alarm [Disabled]

Allows you to enable or disable RTC to generate a wake event. When this item is set to Enabled, the items RTC Alarm Date, RTC Alarm Hour, RTC Alarm Minute, and RTC Alarm Second appear with set values. Configuration options: [Disabled] [Enabled]



The succeeding items appear when the **Power On By RTC Alarm** item is set to Enabled.

RTC Alarm Date

To set the alarm date, highlight this item and press the <+> or <-> key to make the selection. Configuration options: [Everyday] [1] [2] [3]... ~ [31]

RTC Alarm Hour

To set the alarm hour, highlight this item and press the <+> or <-> key to make the selection. Configuration options: [00] [1]... ~ [23]

RTC Alarm Minute

To set the alarm minute, highlight this item and press the <+> or <-> key to make the selection. Configuration options: [00] [1]... ~ [59]

RTC Alarm Second

To set the alarm second, highlight this item and press the <+> or <-> key to make the selection. Configuration options: [00] [1]... ~ [59]

Power On By External Modems [Disabled]

This allows either settings of [Enabled] or [Disabled] for powering up the computer when the external modem receives a call while the computer is in Soft-off mode. Configuration options: [Disabled] [Enabled]



The computer cannot receive or transmit data until the computer and applications are fully running. Thus, connection cannot be made on the first try. Turning an external modem off and then back on while the computer is off causes an initialization string that turns the system power on.

Power On By PCI Devices [Disabled]

When set to [Enabled], this parameter allows you to turn on the system through a PCI LAN or modem card. This feature requires an ATX power supply that provides at least 1A on the +5VSB lead. Configuration options: [Disabled] [Enabled]

Power On By PS/2 Keyboard [Disabled]

Allows you to use specific keys on the keyboard to turn on the system. This feature requires an ATX power supply that provides at least 1A on the +5VSB lead. Configuration options: [Disabled] [Enabled]

Keyboard Wakeup Password

This item appears only when the Power On By PS/2 Keyboard is set to Enabled. Select this item to set or change the keyboard wakeup password. The **Keyboard Wakeup Password** item that appears below shows the default **Not Installed**. After you have set a password, this item shows **Installed**.

Power On By PS/2 Mouse [Disabled]

When set to [Enabled], this parameter allows you to use the PS/2 mouse to turn on the system. This feature requires an ATX power supply that provides at least 1A on the +5VSB lead. Configuration options: [Disabled] [Enabled]

5.5.6 Hardware Monitor

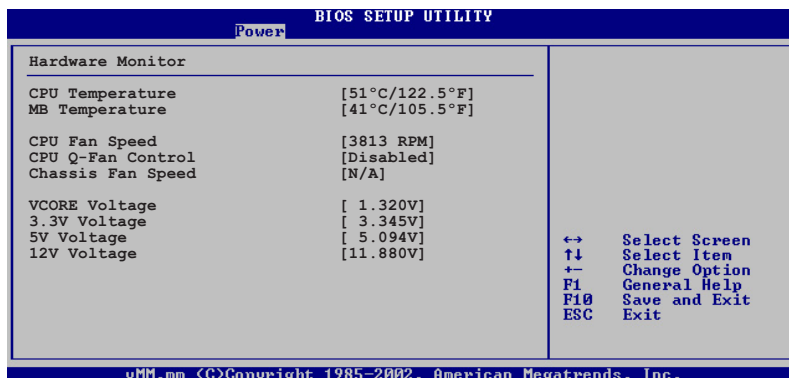

CPU Temperature [xxx°C/xxx°F]

MB Temperature [xxx°C/xxx°F]

The onboard hardware monitor automatically detects and displays the motherboard and CPU temperatures. Select Disabled if you do not wish to display the detected temperatures.

CPU Fan Speed [xxxxRPM] or [N/A]

The onboard hardware monitor automatically detects and displays the CPU fan speed in rotations per minute (RPM). If the fan is not connected to the motherboard, the field shows N/A.

CPU Q-Fan Control [Disabled]

Allows you to enable or disable the ASUS Q-Fan feature that smartly adjusts the fan speeds for more efficient system operation. When this field is set to [Enabled], the **CPU Fan Ratio** item appears to allow selection of the appropriate fan speed ratio. Configuration options: [Disabled] [Enabled]



The **CPU Fan Ratio** and **CPU Target Temperature** items appear only when the **CPU Q-Fan Control** item is set to Enabled.

CPU Fan Ratio [Auto]

Allows you to select the appropriate CPU fan speed ratio for the system. The default [Auto] automatically selects the fan speed ratio when operating a low CPU temperature. Select a higher ratio if you installed additional devices and the system requires more ventilation. Configuration options: [Auto] [90%] [80%] [70%] [60%]



CPU Target Temperature [xxx°C]

Allows you to set the CPU temperature threshold when the CPU fan speed is increased to lower the CPU temperature. Configuration options: [Auto] [53°C] [56°C] [59°C] [62°C] [65°C] [68°C] [71°C] [74°C] [77°C] [80°C] [83°C]

Chassis Fan Speed [xxxxRPM] or [N/A]

The onboard hardware monitor automatically detects and displays the chassis fan speed in rotations per minute (RPM). If the fan is not connected to the chassis, the specific field shows N/A.

VCORE Voltage, 3.3V Voltage, 5V Voltage, 12V Voltage

The onboard hardware monitor automatically detects the voltage output through the onboard voltage regulators.



5.6 Boot menu

The Boot menu items allow you to change the system boot options. Select an item then press <Enter> to display the sub-menu.

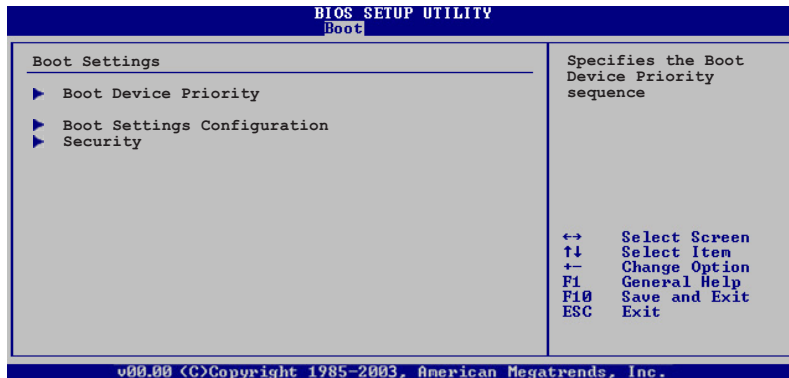

5.6.1 Boot Device Priority

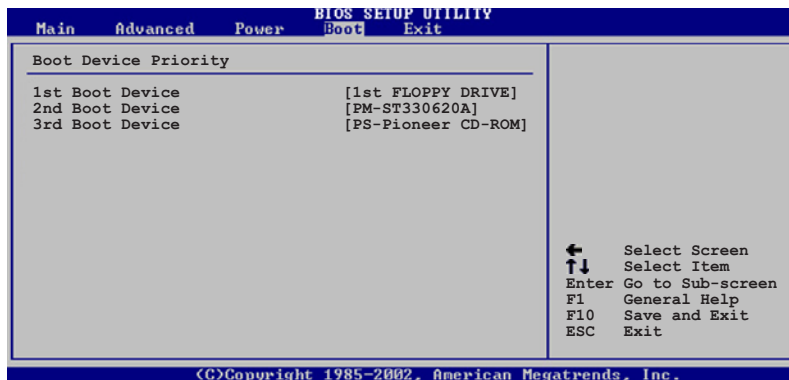

1st ~ 3rd Boot Device [1st Floppy Drive]

These items specify the boot device priority sequence from the available devices. The number of device items that appears on the screen depends on the number of devices installed in the system.

Configuration options: [xxxx Drive] [Disabled]

5.6.2 Boot Settings Configuration

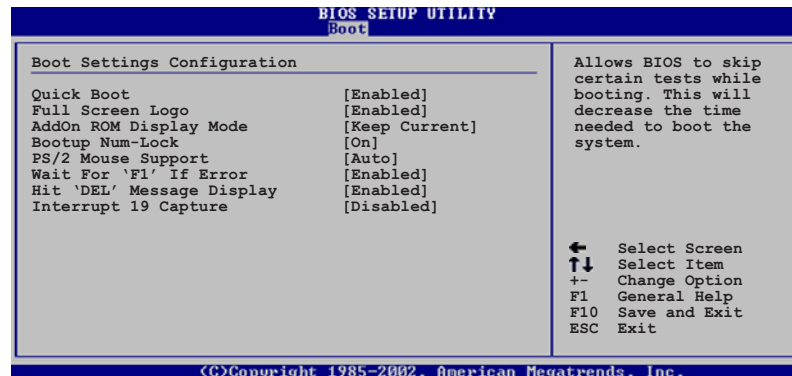

Quick Boot [Enabled]

Enabling this item allows the BIOS to skip some power on self tests (POST) while booting to decrease the time needed to boot the system. When set to [Disabled], BIOS performs all the POST items.

Configuration options: [Disabled] [Enabled]

Full Screen Logo [Enabled]

This allows you to enable or disable the full screen logo display feature.

Configuration options: [Disabled] [Enabled]



Set this item to [Enabled] to use the ASUS MyLogo™ feature.

Add On ROM Display Mode [Keep Current]

Sets the display mode for option ROM.

Configuration options: [Force BIOS] [Keep Current]

Bootup Num-Lock [On]

Allows you to select the power-on state for the NumLock.

Configuration options: [Off] [On]

PS/2 Mouse Support [Auto]

Allows you to enable or disable support for PS/2 mouse.

Configuration options: [Disabled] [Enabled] [Auto]

Wait for 'F1' If Error [Enabled]

When set to Enabled, the system waits for the F1 key to be pressed when error occurs. Configuration options: [Disabled] [Enabled]

Hit 'DEL' Message Display [Enabled]

When set to Enabled, the system displays the message "Press DEL to run Setup" during POST. Configuration options: [Disabled] [Enabled]

Interrupt 19 Capture [Disabled]

When set to [Enabled], this function allows the option ROMs to trap Interrupt 19. Configuration options: [Disabled] [Enabled]

5.6.3 Security

The Security menu items allow you to change the system security settings. Select an item then press <Enter> to display the configuration options.

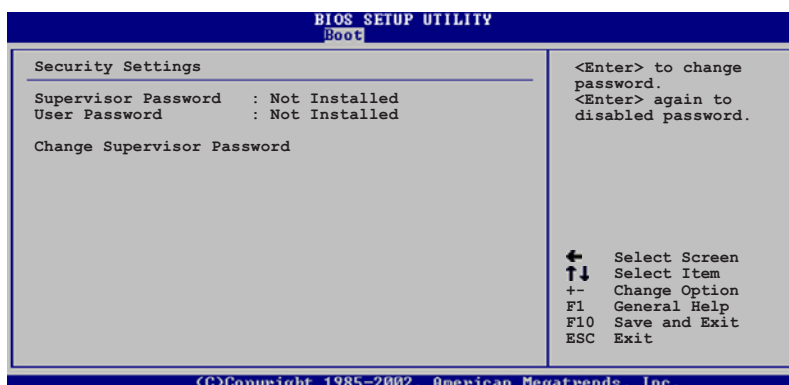

Change Supervisor Password

Select this item to set or change the supervisor password. The Supervisor Password item on top of the screen shows the default **Not Installed**. After you set a password, this item shows **Installed**.

To set a Supervisor Password:

1. Select the Change Supervisor Password item and press <Enter>.
2. From the password box, type a password composed of at least six letters and/or numbers, then press <Enter>.
3. Confirm the password when prompted.

The message "Password Installed" appears after you successfully set your password.

To change the supervisor password, follow the same steps as in setting a user password.

To clear the supervisor password, select the Change Supervisor Password then press <Enter>. The message "Password Uninstalled" appears.



If you forget your BIOS password, you clear it by erasing the CMOS Real Time Clock (RTC) RAM. See section “4.2 Jumpers” for information on how to erase the RTC RAM.

After you have set a supervisor password, the other items appear to allow you to change other security settings.



User Access Level (Full Access)

This item allows you to select the access restriction to the Setup items. Configuration options: [No Access] [View Only] [Limited] [Full Access]

No Access prevents user access to the Setup utility.

View Only allows access but does not allow change to any field.

Limited allows changes only to selected fields, such as Date and Time.

Full Access allows viewing and changing all the fields in the Setup utility.

Change User Password

Select this item to set or change the user password. The User Password item on top of the screen shows the default **Not Installed**. After you set a password, this item shows **Installed**.

To set a User Password:

1. Select the Change User Password item and press <Enter>.
2. On the password box that appears, type a password composed of at least six letters and/or numbers, then press <Enter>.
3. Confirm the password when prompted.

The message "Password Installed" appears after you set your password successfully.

To change the user password, follow the same steps as in setting a user password.

Clear User Password

Select this item to clear the user password.

Password Check [Setup]

When set to [Setup], BIOS checks for user password when accessing the Setup utility. When set to [Always], BIOS checks for user password both when accessing Setup and booting the system.

Configuration options: [Setup] [Always]

5.7 Exit menu

The Exit menu items allow you to load the optimal or failsafe default values for the BIOS items, and save or discard your changes to the BIOS items.

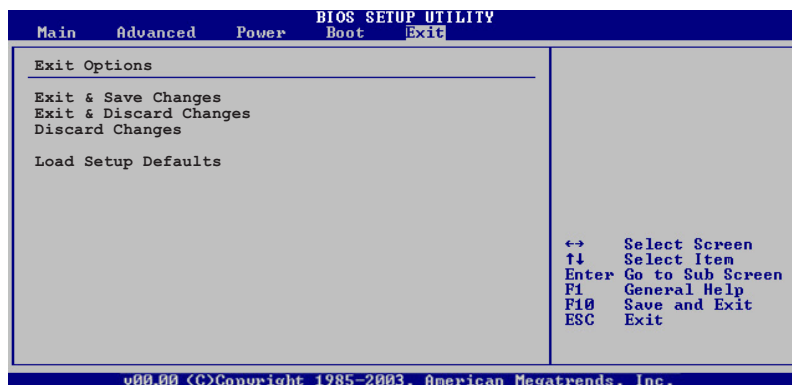

Pressing <Esc> does not immediately exit this menu. Select one of the options from this menu or <F10> from the legend bar to exit.

Exit & Save Changes

Once you are finished making your selections, choose this option from the Exit menu to ensure the values you selected are saved to the CMOS RAM. An onboard backup battery sustains the CMOS RAM so it stays on even when the PC is turned off. When you select this option, a confirmation window appears. Select **Yes** to save changes and exit.



If you attempt to exit the Setup program without saving your changes, the program prompts you with a message asking if you want to save your changes before exiting. Press <Enter> to save the changes while exiting.

Exit & Discard Changes

Select this option only if you do not want to save the changes that you made to the Setup program. If you made changes to fields other than System Date, System Time, and Password, the BIOS asks for a confirmation before exiting.

Discard Changes

This option allows you to discard the selections you made and restore the previously saved values. After selecting this option, a confirmation appears. Select **Yes** to discard any changes and load the previously saved values.



Load Setup Defaults

This option allows you to load the default values for each of the parameters on the Setup menus. When you select this option or if you press <F5>, a confirmation window appears. Select **Yes** to load default values. Select **Exit & Save Changes** or make other changes before saving the values to the non-volatile RAM.



