



Xonar DX

PCI Express Audio Card

Quick Installation Guide

1.1 Installation requirements

To ensure a successful installation of the Xonar DX audio card, your computer must meet the following requirements:

- One PCI Express 1.0 (or higher) compatible slot for the audio card
- One available 4-pin power cable from PC's power supply unit
- Microsoft® Windows® Vista/XP(32/64bit)/MCE2005
- Intel® Pentium® 4 1.4GHz or AMD Athlon 1400 CPU or faster CPU
- > 256 MB DRAM system memory
- > 60 MB available HDD space for driver installation package; > 200MB space available for Ableton Live and > 320MB for Cakewalk package
- CD-ROM drive (or DVD-ROM drive) for software installation
- High-quality headphones, powered analog speakers, or digital speakers with Dolby Digital decoder to enjoy the Ultra-High Fidelity sounds of the card

Before the installation, check your ASUS Xonar DX audio card package for the following items:

- ASUS Xonar DX audio card
- ASUS Xonar DX support CD (including Portable Music Processor™ Lite and RMAA V6.0.6 utilities)
- Additional low-profile bracket
- S/PDIF TOSLINK optical adaptor x1
- Quick Installation Guide

1.2 Card installation

To install the Xonar DX audio card:

1. Touch the metal back or side panel of the computer to avoid static electricity.
2. Power OFF the computer, the monitor, and all other peripheral devices connected to your computer.
3. Unplug the computer power cord from your computer and power outlet.
4. Remove the chassis cover.
5. Locate an empty PCIE slot on the motherboard.
6. Connect the power cable of the power supply to the power connector on the audio card.
7. Align and insert the audio card into the PCIE slot until it seats in place. Make sure the goldfingers are properly inserted to the slot.
8. Secure the bracket screw that holds the audio card in place. Refer to the picture below for the bracket screw hole.
9. Put back the chassis cover.
10. Reconnect all cables.
11. Plug the power cord to the computer and to a power outlet.
12. Power ON the computer.



The PCI Express high-quality audio card requires additional power from your computer. If the power cable is not connected properly, the audio card will not work at all.

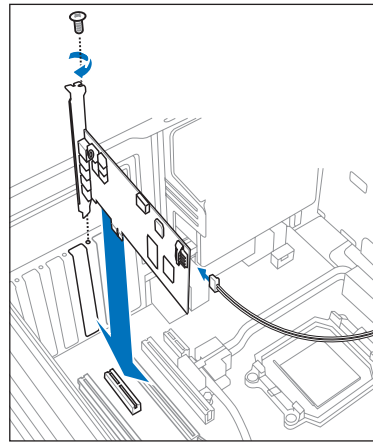

When removing the power cable from the Xonar DX audio card, make sure to pull outward the 4-pin header first, then unplug it from the power connector as the following pictures show. Do not forcefully remove the header from the power connector; doing so may pull up the power connector from the audio card and cause damage!

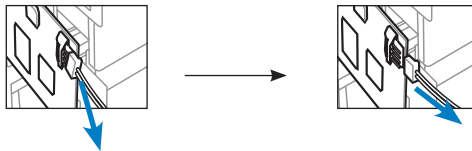

1.3 Driver installation

After installing the Xonar DX audio card on your computer, you need to install the device driver that enables the Xonar DX audio card to work with Windows operating system.



The version and content of the driver CD are subject to change without notice.

If you have already installed the ASUS Xonar DX audio card, the Found New Hardware Wizard window may pop up before or during driver installation. See figure below.



1.3.1 Installing the Audio Card Driver

To install the device driver:

1. Click **Cancel** from the **Found New Hardware wizard** window.
2. Insert the ASUS Xonar DX support CD into your optical drive.
If autorun is enabled, the ASUS Xonar Card Driver screen appears automatically. Go to step 5.
If Autorun is not enabled in your computer, perform step 3.
3. Click **My Computer** on your desktop and double-click the optical drive icon.
4. Double-click the **setup.exe** icon located on the optical drive.
5. Follow the on-screen instructions to complete the installation. Read the “**END USER LICENSE AGREEMENT**” in the process and make sure that you understand and accept it before continuing the installation.
6. When the installation finishes, you may be prompted to restart your computer. You can choose to restart the computer later if desired.

1.4 Connecting audio device

1.4.1 Back ports

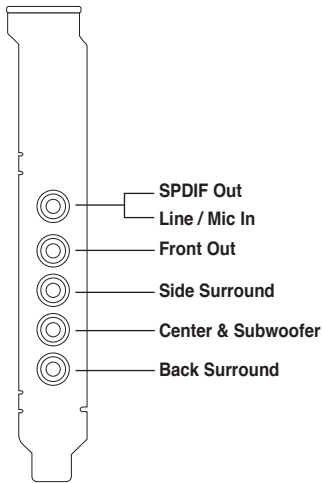

1.4.2 Connecting analog speakers

2 Speakers

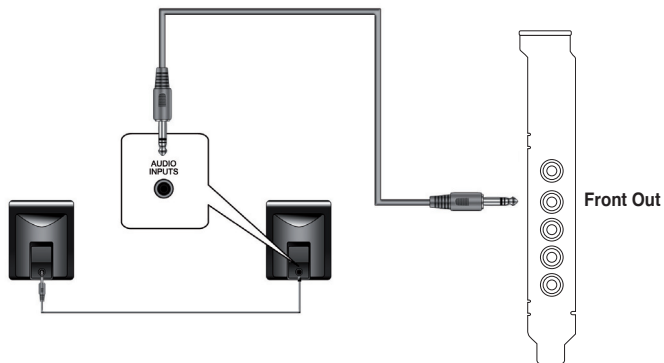

2.1 Speakers

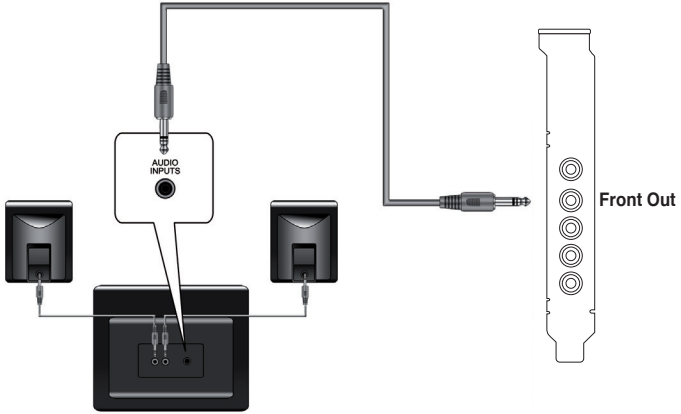

4 Speakers

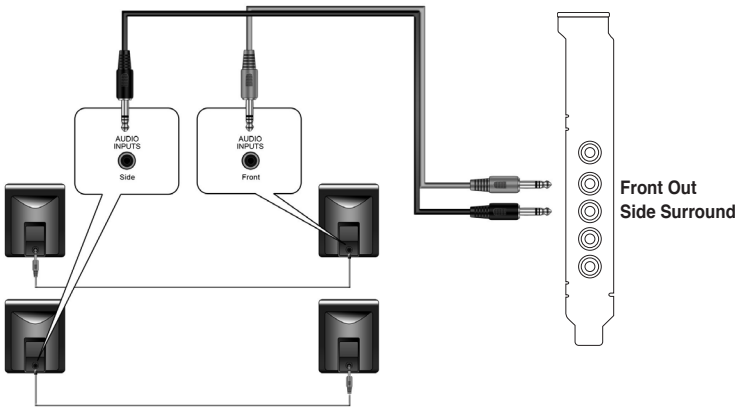

4.1 Speakers

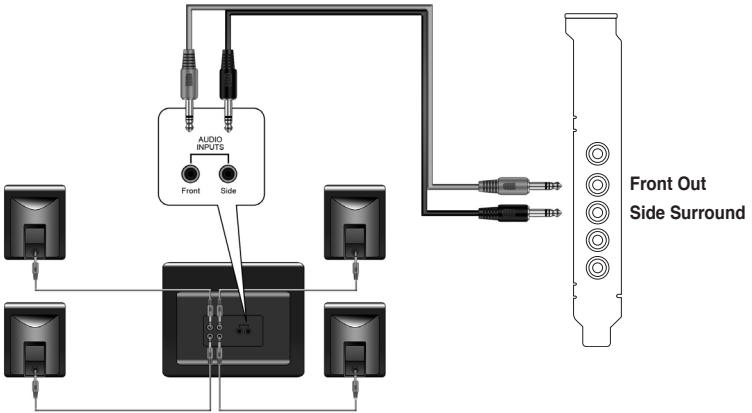

5.1 Speakers

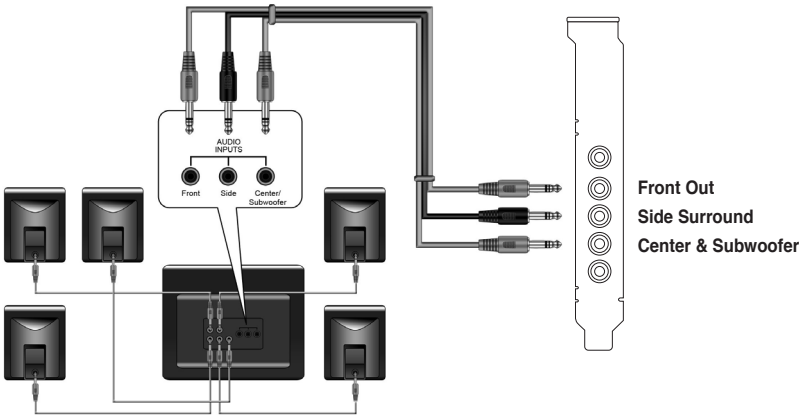

6.1 Speakers

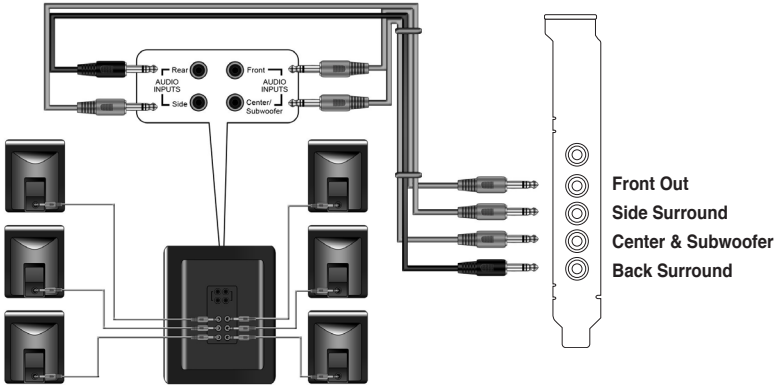

7.1 Speakers

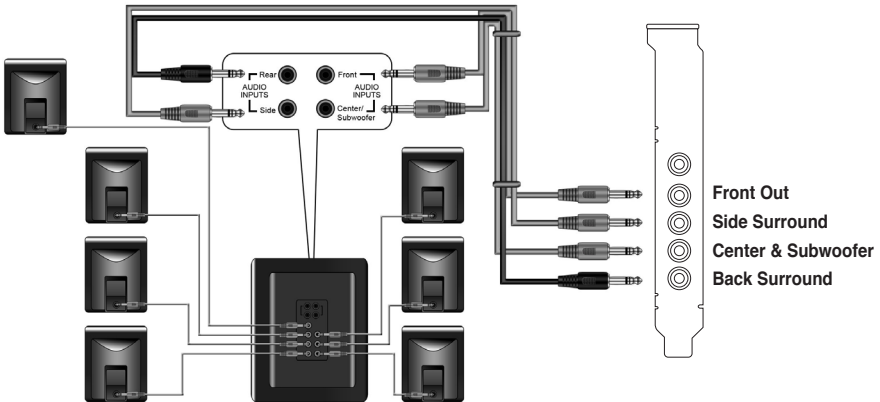

1.4.3 Connecting digital speakers

SPDIF Out

Plug the optical TOSLINK adaptor into the S/PDIF-Out combo connector. Then, connect your decoder's S/PDIF in port to the optical adaptor with the TOSLINK optical cable.



You can also use a coaxial cable for a S/PDIF connection. Just plug the coaxial RCA male connector to the S/PDIF-Out combo jack and connect the other end into the coaxial S/PDIF input on your decoder.

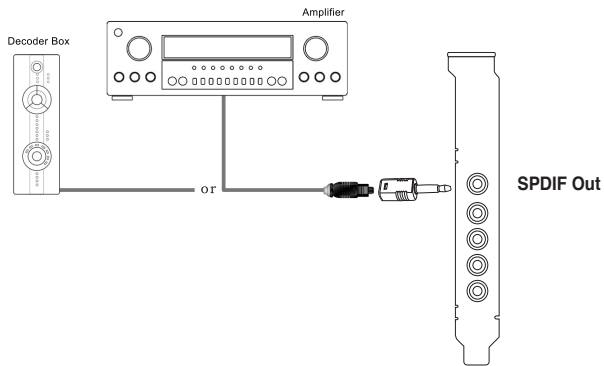

1.4.4 Connecting Line-In audio sources

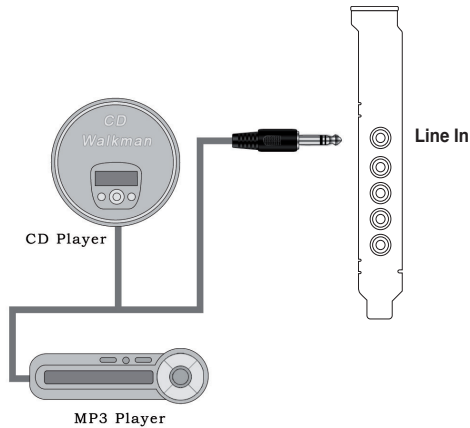

1.4.5 Connecting headphone / microphone

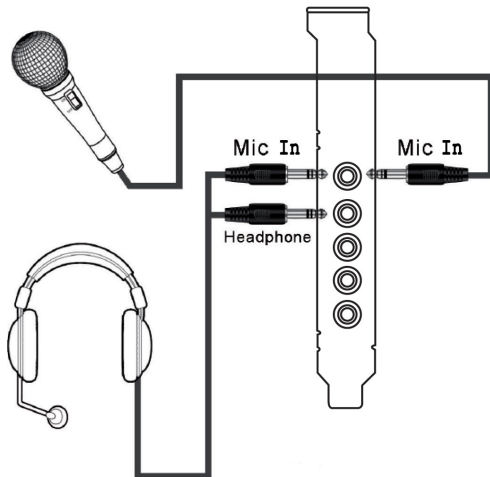



Xonar DX

Carte son PCI Express

Français

Guide d'installation rapide

1.1 Configuration requise

Avant d'installer la carte son Xonar DX, assurez-vous que votre ordinateur puisse satisfaire aux critères suivants:

- PC avec un slot PCI Express 1.0 (ou supérieur) disponible pour la carte son
- Un câble d'alimentation 4 broches disponible
- Microsoft® Windows® Vista/XP(32/64bits)/MCE2005
- Un processeur Intel® Pentium® 4 1.4GHz ou AMD Athlon 1400 ou supérieur
- > Mémoire DRAM supérieure à 256 Mo
- > Plus de 60 Mo d'espace disque disponible pour l'installation des pilotes; plus de 200 Mo d'espace disque disponible pour l'installation du pack Ableton Live et plus de 320 Mo pour l'installation du pack Cakewalk
- Un lecteur de CD-ROM (ou DVD-ROM) pour l'installation des logiciels
- Des écouteurs de haute qualité, des haut-parleurs analogiques ou numériques intégrant un décodeur Dolby Digital pour profiter pleinement de la qualité audio délivrée par la carte son

Avant l'installation, vérifiez que la boîte de votre carte son ASUS Xonar DX contient les éléments suivants:

- Carte son ASUS Xonar DX
- CD de support ASUS Xonar DX (incluant les utilitaires Portable Music Processor™ Lite et RMAA V6.0.6)
- Support demi-hauteur additionnel
- Adaptateur S/PDIF optique TOSLINK x1
- Guide d'installation rapide

1.2 Installation de la carte

Pour installer la carte son Xonar DX :

1. Touchez une des parties métalliques de votre châssis pour vous décharger de l'électricité statique.
2. Eteignez l'ordinateur, le moniteur, ainsi que tous les autres périphériques connectés à votre PC.
3. Débranchez le cordon d'alimentation de votre ordinateur et de la prise électrique.
4. Retirez le panneau latéral du châssis.
5. Localisez un slot PCI-Express libre sur la carte mère.
6. Connectez un des câbles du bloc d'alimentation au connecteur d'alimentation de la carte son.
7. Alignez et insérez la carte son sur le slot PCI-E jusqu'à ce qu'elle soit bien en place. Assurez-vous que les connecteurs dorés sont correctement insérés dans le slot.
8. Sécurisez la carte son au châssis à l'aide d'une vis. Référez-vous à l'illustration ci-dessous pour localiser le pas de vis.
8. Remplacez le panneau latéral du châssis.
9. Reconnectez tous les câbles.
10. Branchez une extrémité du cordon d'alimentation au bloc d'alimentation de votre ordinateur puis l'autre extrémité à une prise électrique.
11. Allumez l'ordinateur.



La carte son PCI Express nécessite une source d'alimentation. Si le câble d'alimentation n'est pas correctement connecté, la carte son ne pourra pas fonctionner.

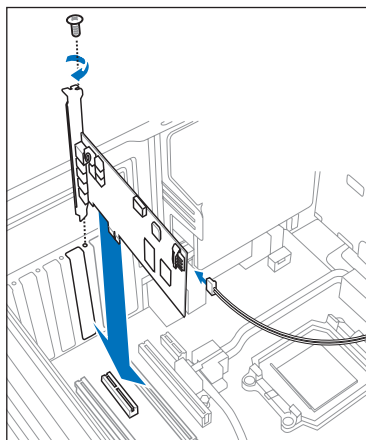

Lors de la déconnexion du câble d'alimentation de la carte son Xonar DX, assurez-vous de d'abord tirer vers vous le connecteur 4 broches tel qu'illustré ci-dessous. Ne forcez pas le connecteur hors du port d'alimentation de la carte; vous pourriez l'endommager.

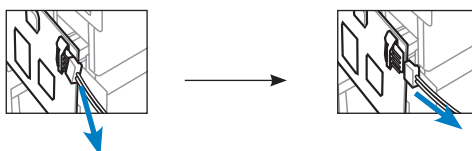

1.3 Installation des pilotes

Une fois la carte son Xonar DX installée sur votre ordinateur, vous devrez installer le pilote permettant à la carte son Xonar DX de fonctionner sous un système d'exploitation Windows.



La version et le contenu du CD des pilotes peuvent changer sans avertissement.

Si vous avez déjà installé la carte son ASUS Xonar DX, la fenêtre de l'Assistant Ajout de nouveau matériel détecté peut apparaître avant ou pendant le processus d'installation des pilotes. Voir la figure ci-dessous.



1.3.1 Installer le pilote de la carte son

Pour installer le pilote de la carte son:

1. Cliquez sur **Annuler** lors de l'apparition de la fenêtre de l'**Assistant ajout de nouveau matériel**.
2. Insérez le CD de support de la carte son ASUS Xonar DX dans votre lecteur optique.
Si l'Exécution automatique est activée, l'écran d'installation du pilote ASUS Xonar Card Driver apparaît automatiquement. Passez directement à l'étape 5.
Si l'Exécution automatique n'est pas activée sur votre PC, passez à l'étape 3.
3. Cliquez sur **Poste de travail** et double-cliquez sur l'icône de votre lecteur optique.
4. Double-cliquez sur l'icône **setup.exe** du CD de support.
5. Suivez les instructions apparaissant à l'écran pour terminer l'installation. Lisez le contrat de licence "**END USER LICENSE AGREEMENT**" et acceptez-le pour pouvoir continuer.
6. Une fois l'installation terminée, il peut vous être demandé de redémarrer votre ordinateur. Vous pouvez toutefois choisir de redémarrer ultérieurement.

1.4 Connecter un périphérique audio

1.4.1 Ports arrières

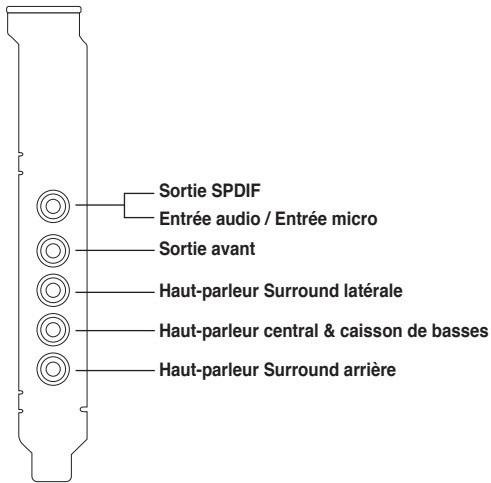

1.4.2 Connecter des haut-parleurs analogiques

Configuration à 2 haut-parleurs

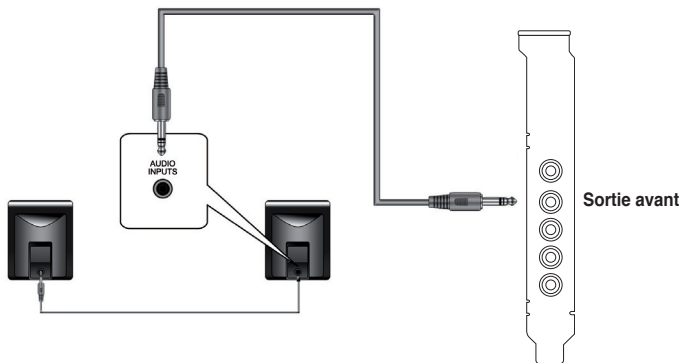

Configuration 2.1

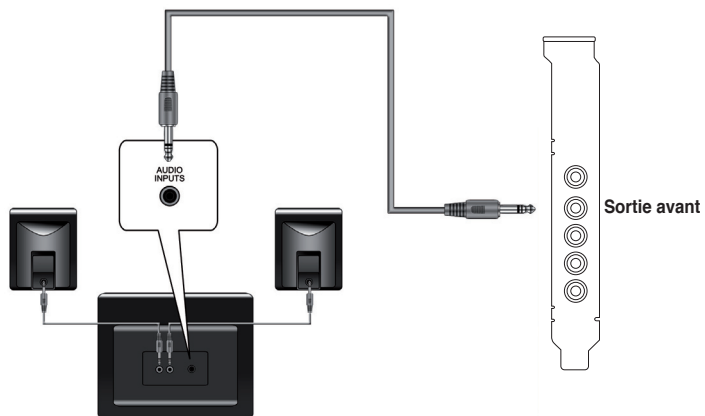

Configuration à 4 haut-parleurs

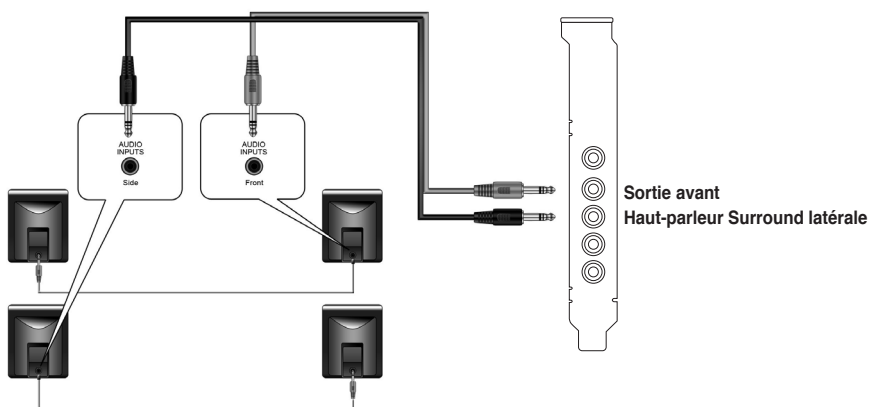

Configuration 4.1

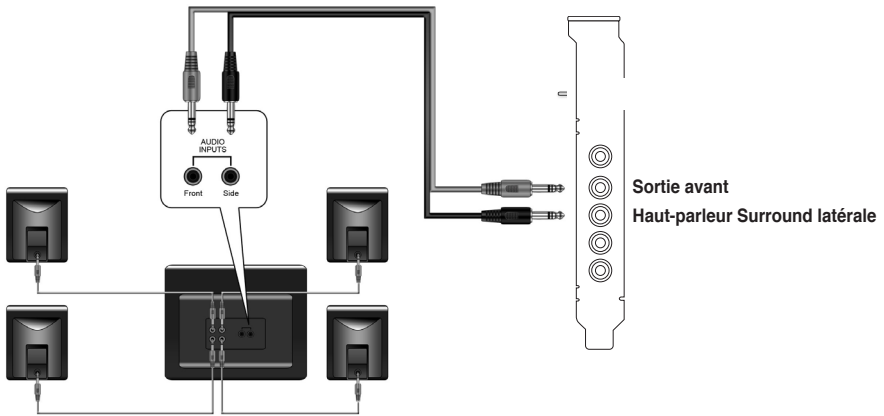

Français

Configuration 5.1

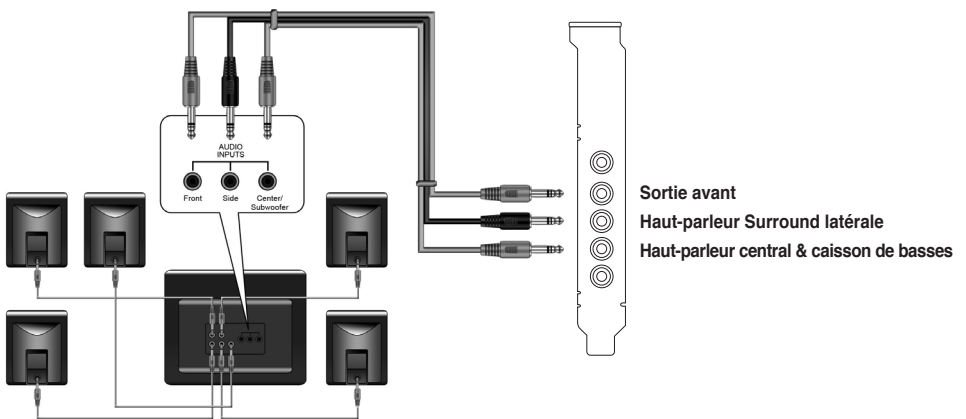

Configuration 6.1

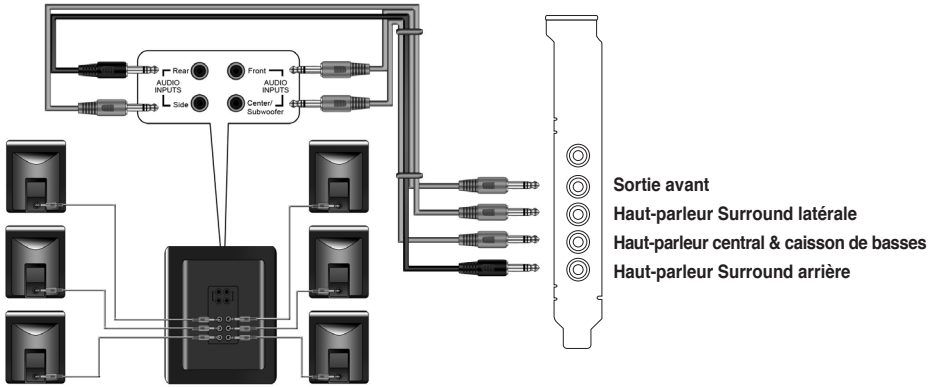

Configuration 7.1

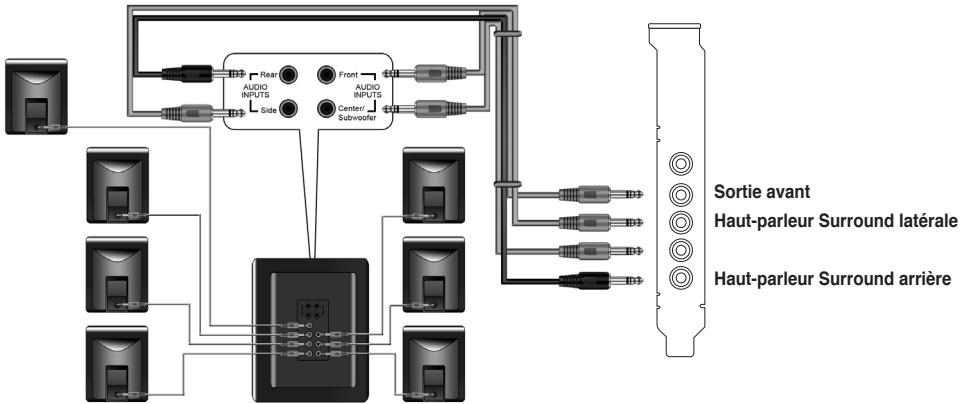

1.4.3 Connecter des haut-parleurs numériques

Sortie SPDIF

Branchez l'adaptateur TOSLINK optique sur le connecteur S/PDIF-Out. Puis, connectez le port d'entrée S/PDIF de votre lecteur MD/CD/DVD à l'adaptateur optique du câble TOSLINK.



Vous pouvez aussi utiliser un câble coaxial pour une connexion S/PDIF. Connectez simplement une extrémité du connecteur mâle RCA coaxial au connecteur S/PDIF-Out, puis l'autre extrémité au port d'entrée S/PDIF coaxial de votre lecteur.

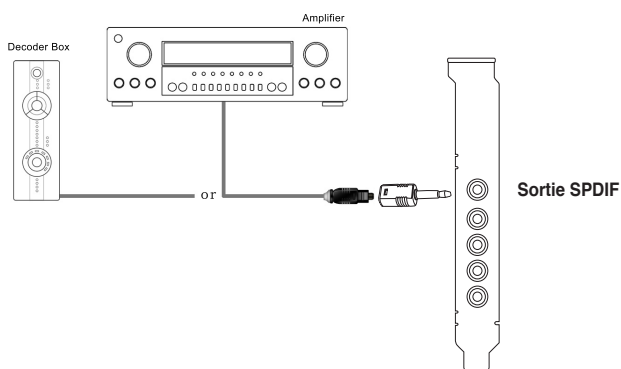

1.4.4 Connexion de sources audio entrantes

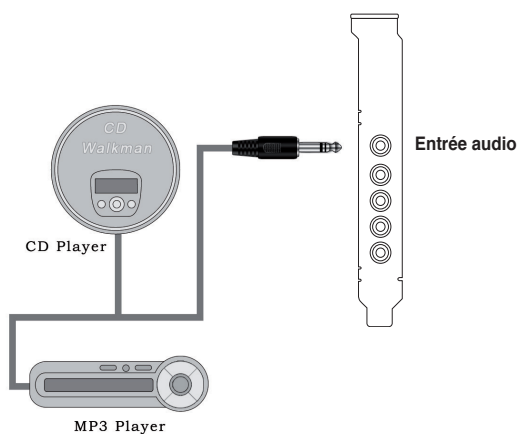

1.4.5 Connexion d'un casque / microphone

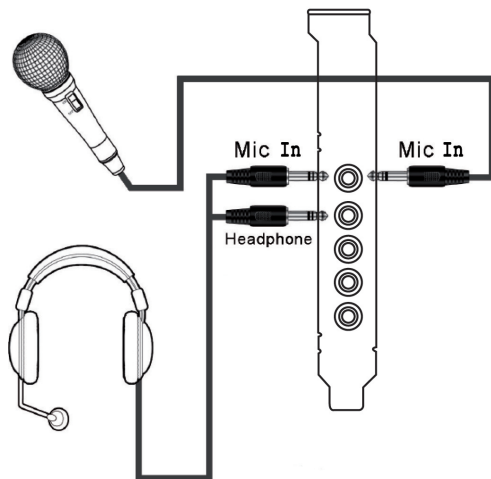



Xonar DX

PCI Express Audio- Karte

Deutsch

Schnellinstallationsanleitung

1.1 Installationsanforderungen

Um eine erfolgreiche Installation der Xonar DX Audio-Karte sicherzustellen muss Ihr Computer die folgenden Voraussetzungen erfüllen:

- 1x PCI Express 1.0 (oder höher) kompatibler Steckplatz für die Audio-Karte
- 1x verfügbares 4-pol. Stromversorgungskabel vom Netzteil
- Microsoft® Windows® Vista/XP(32/64Bit)/MCE2005
- Intel® Pentium® 4 1,4GHz oder AMD Athlon 1400 Prozessor oder höher
- > 256 MB DRAM Systemspeicher
- > 60 MB freier Festplattenspeicherplatz für die Treiberinstallationspack; > 200MB freier Festplattenspeicherplatz für Ableton Live und > 320MB für Cakewalk-Pack
- CD/DVD-ROM-Laufwerk für Software-Installation
- Hochqualitative Kopfhörer, aktive Analoglautsprecher oder digitale Lautsprecher mit Dolby Digital-Dekoder, um den Ultra-HiFi-Sound dieser Karte zu erleben

Vor der Installation überprüfen Sie Ihre ASUS Xonar DX Audio-Kartenverpackung auf folgenden Inhalt:

- ASUS Xonar DX Audio-Karte
- ASUS Xonar DX-Hilfs-CD (Eingeschlossen der Portable Music Processor™ Lite und RMAA V6.0.6-Hilfsprogramme)
- Zusätzliche flache Klammer
- S/PDIF TOSLINK optischer Adapter 1x
- Schnellinstallationsanleitung

1.2 Karteneinbau

So bauen Sie die Xonar DX Audio-Karte ein:

1. Berühren Sie die metallene Rückseite des Computers, um statische Aufladungen zu vermeiden.
2. Schalten Sie die Computer, den Monitor und alle Peripheriegeräte, die mit dem Computer verbunden sind, aus.
3. Ziehen Sie das Netzkabel des Computers aus der Steckdose und aus dem Computer heraus.
4. Entfernen Sie die Gehäuseabdeckung.
5. Suchen Sie einen leeren PCIE-Steckplatz auf dem Motherboard.
6. Verbinden Sie das Stromversorgungskabel vom Netzteil mit dem Stromanschluß der Audio-Karte.
7. Richten Sie die Audio-Karte im PCIE-Steckplatz aus und stecken Sie sie hinein, bis die Karte richtig sitzt. Vergewissern Sie sich, dass die Goldkontakte richtig im Steckplatz stecken.
8. Sichern Sie die Karte mit einer Schraube, siehe rechte Abbildung.
9. Schließen Sie die Gehäusabdeckung.
10. Schließen Sie alle Kabel wieder an.
11. Stecken Sie das Netzkabel wieder in die Steckdose und in den Computer.
12. Schalten Sie den Computer ein.



Die PCI Express High-Quality-Adio-Karte benötigt eine zusätzliche Stromversorgung von Ihrem Computer. Wenn das Stromversorgungskabel nicht richtig angeschlossen ist, wird die Karte nicht arbeiten.

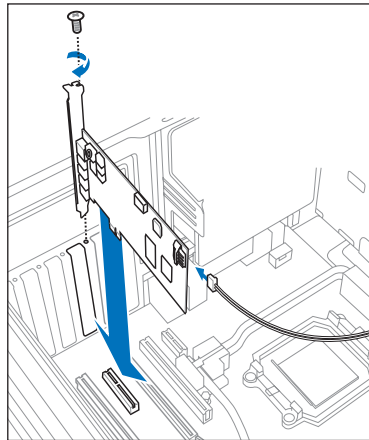

Wenn das Stromversorgungskabel von der Xonar DX Audio-Karte entfernt wird, vergewissern Sie sich, dass Sie den 4-pol. Stecker nach außen ziehen und danach das Kabel abziehen, so wie in den folgenden Abbildungen gezeigt. Entfernen Sie den Stecker nicht gewaltsam vom Anschluß, weil dabei der Anschluß für die Stromversorgung von der Audio-Karte abgerissen werden könnte und dieses beschädigt wird!

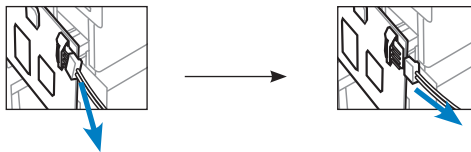

1.3 Treiberinstallation

Nach dem Einbau der Xonar DX Audio-Karte in Ihren Computer müssen Sie die Gerätetreiber installieren, damit die Xonar DX Audio-Karte mit dem Windows-Betriebssystem zusammenarbeiten kann.



Die Version und der Inhalt der Treiber-CD können ohne vorherige Ankündigung geändert werden.

Wenn Sie die ASUS Xonar DX Audio-Karte schon eingebaut haben, erscheint möglicherweise vor oder während der Treiberinstallation ein Fenster des Hardware-Assistenten (Neue Hardware gefunden). Siehe folgende Abbildung.

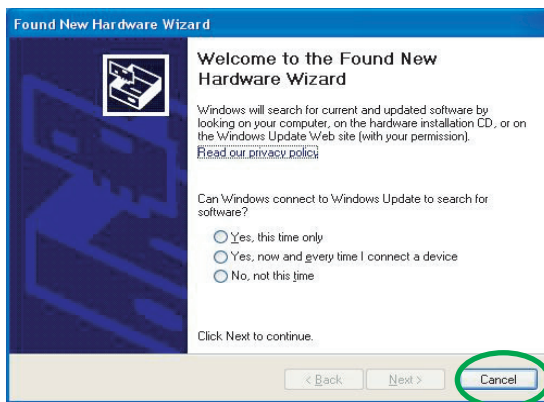

Deutsch

1.3.1 Installation der Audio-Kartentreiber

So installieren Sie die Gerätetreiber:

1. Klicken Sie im Fenster **Neue Hardware gefunden** auf **Abbrechen**.
2. Legen Sie die ASUS Xonar DX-Hilfs-CD in das optische Laufwerk ein. Wenn Autorun aktiviert ist, erscheint das Fenster für die ASUS Xonar-Kartentreiber automatisch und Sie können mit Schritt 5 fortfahren. Wenn Autorun nicht aktiviert ist fahren Sie mit Schritt 3 fort.
3. Klicken Sie auf Ihrem Bildschirm auf **Arbeitsplatz** und doppelklicken Sie auf das Symbol Ihres optischen Laufwerks.
4. Doppelklicken Sie auf das Symbol **setup.exe**, welches Sie auf der CD finden.
5. Folgen Sie den Bildschirmanweisungen, um die Installation fertigzustellen. Lesen Sie die **“Endbenutzer-Lizenzbestimmungen”** und vergewissern Sie sich, dass Sie alles verstanden haben. Akzeptieren Sie dann die bestimmungen, bevor Sie mit der Installation fortfahren.
6. Wenn die Installation beendet ist, werden Sie aufgefordert Ihren Computer neu zu starten. Sie können den Computer später neu starten, wenn gewünscht.

1.4 Audio-Gerät anschließen

1.4.1 Rückseitige Anschlüsse

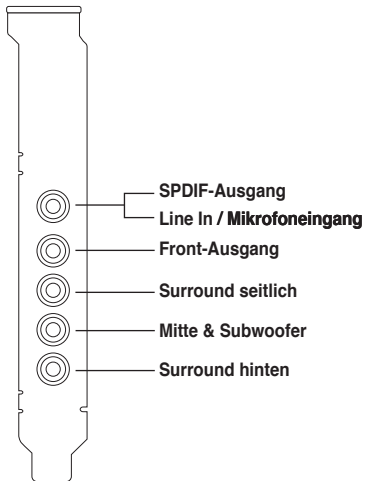

Deutsch

1.4.2 Analoge Lautsprecher anschließen

2 Lautsprecher

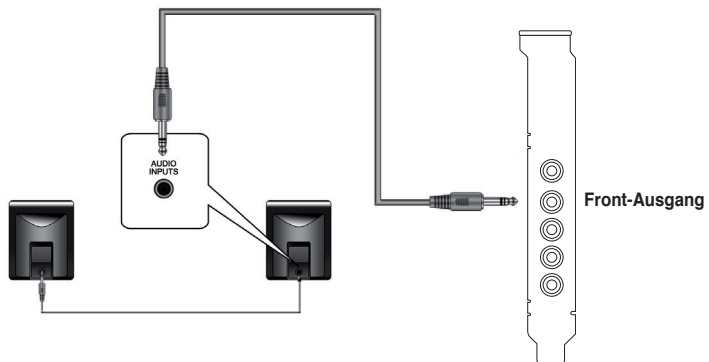

2.1 Lautsprecher

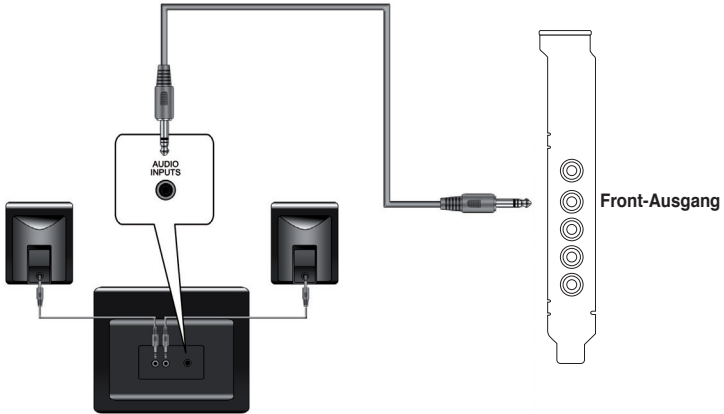

4 Lautsprecher

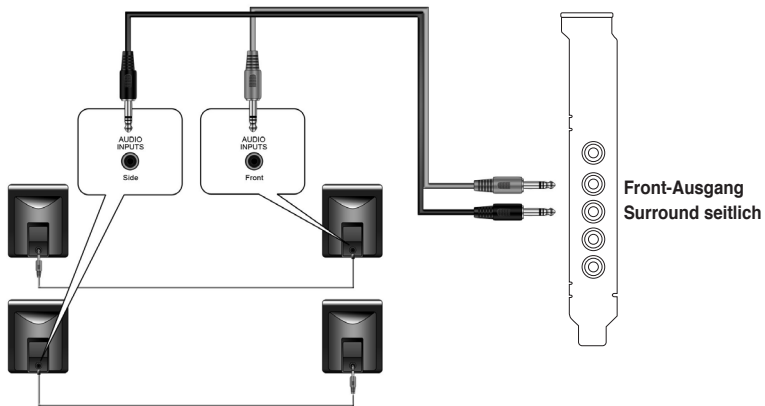

4.1 Lautsprecher

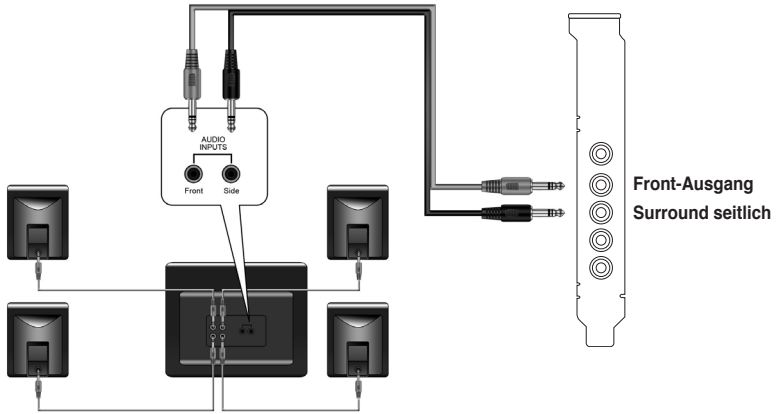

Deutsch

5.1 Lautsprecher

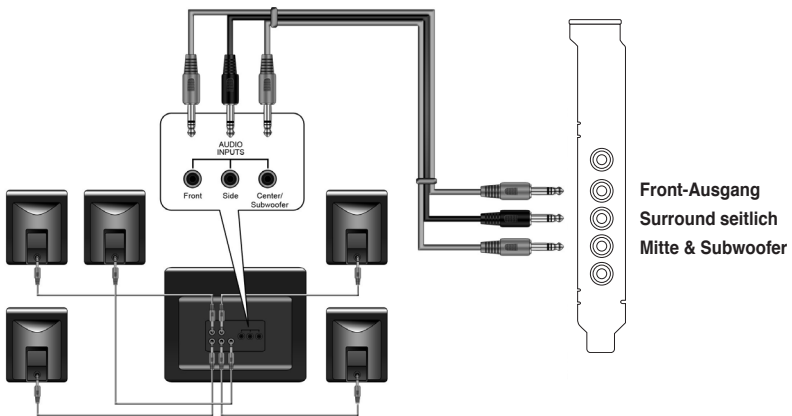

6.1 Lautsprecher

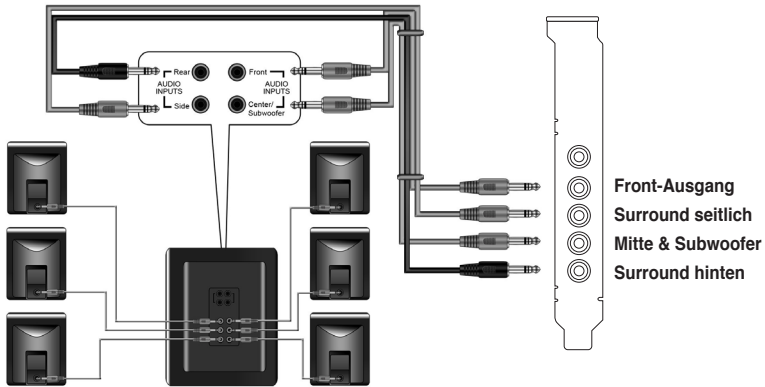

7.1 Lautsprecher

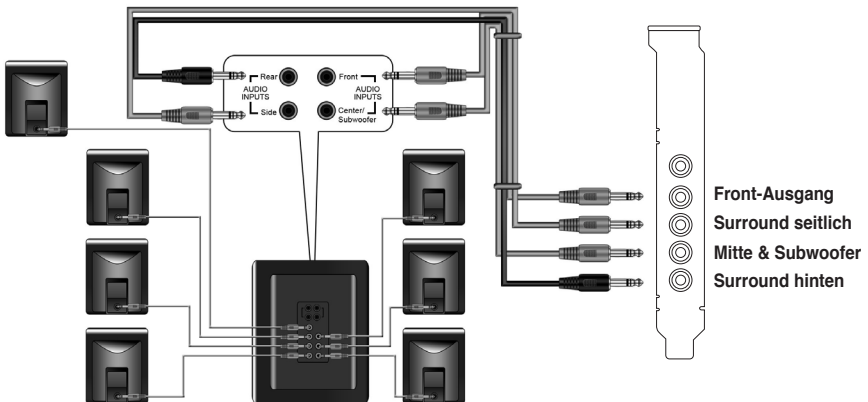

1.4.3 Digitale Lautsprecher anschließen

SPDIF-Ausgang

Stecken Sie den optischen TOSLINK-Adapter in den S/PDIF-Combo-Ausgang. Verbinden Sie dann den S/PDIF-Eingang Ihres Decoders mit dem TOSLINK-Kabel mit dem optischen Adapter.



Sie können auch ein Koaxialkabel für die S/PDIF-Verbindung benutzen. Stecken Sie einfach den Koaxial-RCA-Stecker in den S/PDIF-Combo-Ausgang und verbinden Sie das andere Ende mit dem S/PDIF-Koaxialeingang Ihres Decoders.

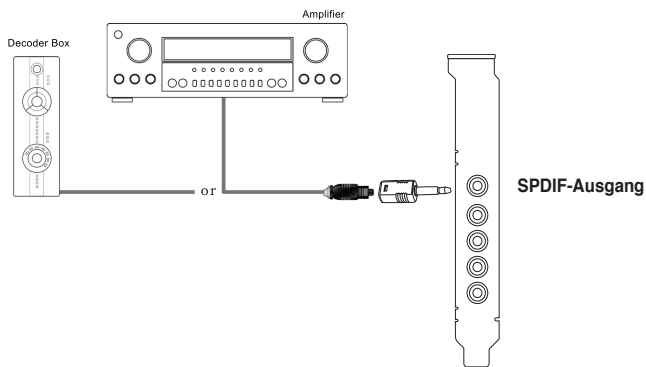

Deutsch

1.4.4 Line-In-Audio-Quellen anschließen

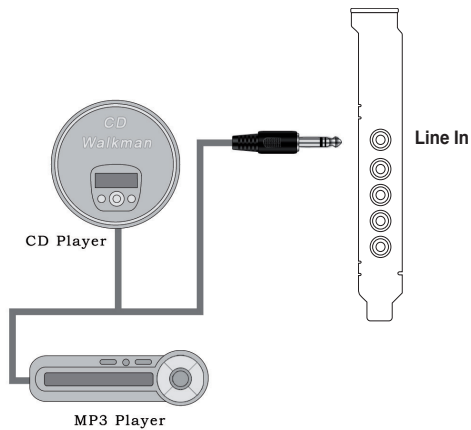

1.4.5 Anschluß von Kopfhörern/Mikrofon

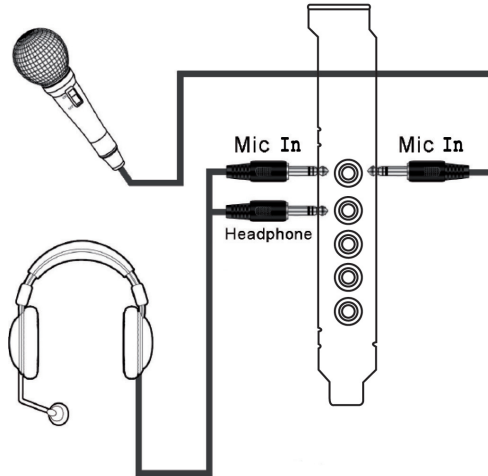

Deutsch



Xonar DX

Scheda Audio
PCI Express

Guida all'installazione rapida

italiano

1.1 Requisiti per l'installazione

Per assicurare la corretta installazione della scheda audio Xonar DX, il computer deve soddisfare i seguenti requisiti:

- Un alloggiamento compatibile PCI Express 1.0 (o superiore) per la scheda audio
- Un cavo d'alimentazione a 4 pin disponibile dall'alimentatore del PC
- Microsoft® Windows® Vista/XP (32/64bit)/MCE2005
- CPU Intel® Pentium® 4 1.4GHz o CPU AMD Athlon 1400 CPU o CPU più potente
- > 256 MB di memoria di sistema DRAM
- > 60 MB di spazio disponibile su HDD per l'installazione del pacchetto driver; > 200MB di spazio libero per Ableton Live e > 320MB il pacchetto Cakewalk
- Unità CD-ROM (o DVD-ROM) per l'installazione del driver
- Cuffie di alta qualità, con altoparlanti analogici o digitali e decodificatore Dolby Digital per un'ottima riproduzione del suono.

Prima dell'installazione, controllare che la confezione della scheda audio ASUS Xonar DX contenga i seguenti elementi:

- Scheda audio ASUS Xonar DX
- CD di supporto ASUS Xonar DX (compreso Portable Music Processor™ Lite e utilità RMAA V6.0.6)
- Staffa Aggiuntiva a Basso Profilo
- Adattatore Ottico S/PDIF TOSLINK x1
- Guida all'installazione rapida

1.2 Installazione della scheda

Per installare la scheda audio Xonar DX:

1. Toccare la staffa metallica o i pannelli laterali del computer per scaricare l'elettricità statica.
2. Spegnerne il computer, il monitor e tutte le altre periferiche collegate al computer.
3. Scollegare il cavo d'alimentazione dal computer e dalla presa di corrente.
4. Rimuovere la copertura del telaio.
5. Individuare un alloggiamento PCIE vuoto sulla scheda madre.
6. Collegare il cavo d'alimentazione dell'alimentatore al connettore d'alimentazione della scheda audio.
7. Allineare ed inserire la scheda audio nell'alloggiamento PCIE finché è introdotta completamente. Assicurarsi che i contatti dorati della scheda siano inseriti completamente nell'alloggio.
8. Fissare le viti che fissano la scheda audio. Fare riferimento all'immagine che segue per il rimando ai fori della staffa.
9. Rimettere la copertura del telaio.
10. Ricollegare tutti i cavi.
11. Collegare il cavo d'alimentazione al computer ed alla presa di corrente.
12. Accendere il computer.



La scheda PCI Express ad alta qualità richiede ulteriore corrente elettrica dal computer. Se il cavo d'alimentazione non è collegato in modo appropriato, la scheda audio non funzionerà.

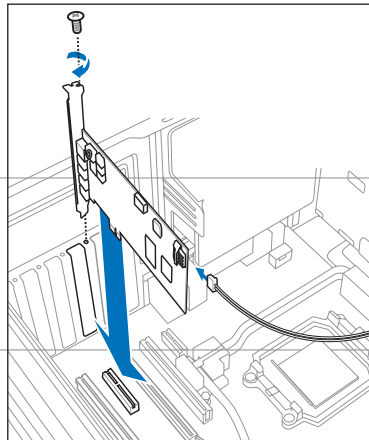

Italiano



Quando si rimuove il cavo d'alimentazione dalla scheda audio Xonar DX, assicurarsi di estrarre prima il collettore a 4 pin, poi scollegarlo dal connettore d'alimentazione come mostrato nelle immagini che seguono. Non esercitare forza quando si rimuove il collettore dal connettore d'alimentazione, diversamente si può staccare il connettore d'alimentazione dalla scheda audio e causare danni!

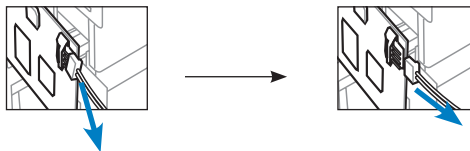

1.3 Installazione del driver

Dopo avere installato la stazione la scheda audio Xonar DX sul computer, è necessario installare il driver periferica che abilita la scheda audio Xonar DX a funzionare insieme al sistema operativo Windows.



La versione ed i contenuti del CD driver sono soggetti a modifica senza preavviso.

Se la scheda audio Xonar DX è già stata installata, prima o durante l'installazione del driver potrebbe apparire la finestra di dialogo Installazione guidata nuovo hardware. Fare riferimento alla figura che segue.



1.3.1 Installazione del driver scheda audio

Per installazione il driver della periferica:

1. Fare clic su **Annulla** nella finestra **Installazione guidata nuovo hardware**.
2. Inserire il CD di supporto ASUS Xonar DX nell'unità ottica.

Se la funzione d'esecuzione automatica è abilitata, la schermata ASUS Xonar Card Driver appare automaticamente. Andare al punto 5.

Se sul computer non è attivata la funzione d'esecuzione automatica, eseguire le istruzioni del punto 3.

3. Fare doppio clic sull'icona del desktop **Risorse del Computer** e fare doppio clic sull'icona dell'unità ottica.
4. Fare doppio clic sull'icona **setup.exe** dell'unità ottica.
5. Seguire le istruzioni su schermo per completare l'installazione. Leggere i contenuti di **"Contratto di licenza"** ed assicurarsi di capirlo e di accettarlo prima di continuare con l'installazione.
6. Al termine dell'installazione, potrebbe essere richiesto di riavviare il computer. Se voluto, si può scegliere di riavviare il sistema in un secondo tempo.

1.4 Connessione dei Dispositivi Audio

1.4.1 Porte Posteriori

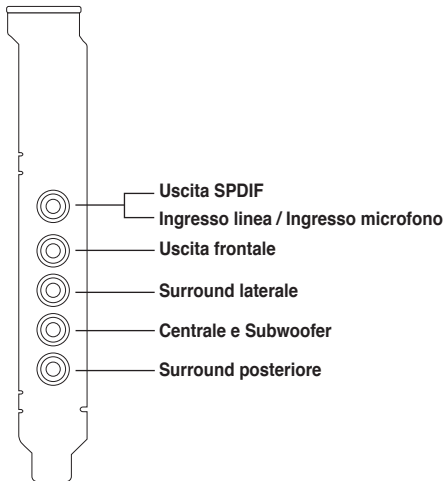

1.4.2 Connessione degli Altoparlanti Analogici

2 Casse

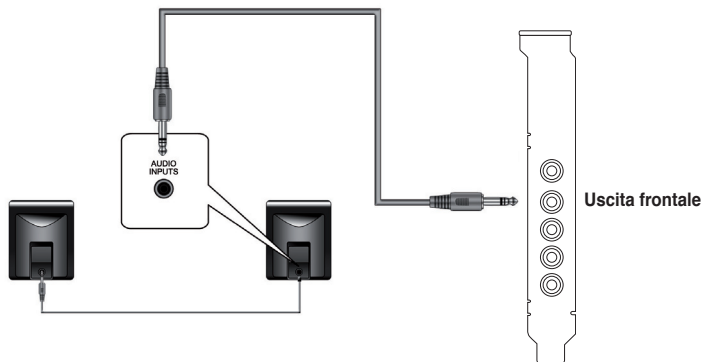

2.1 Casse

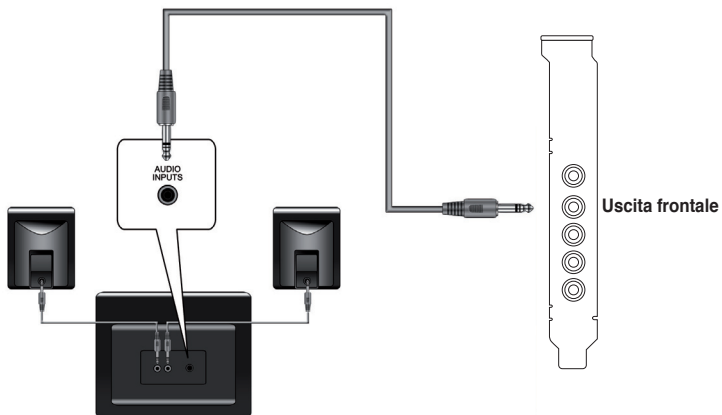

Italiano

4 Casse

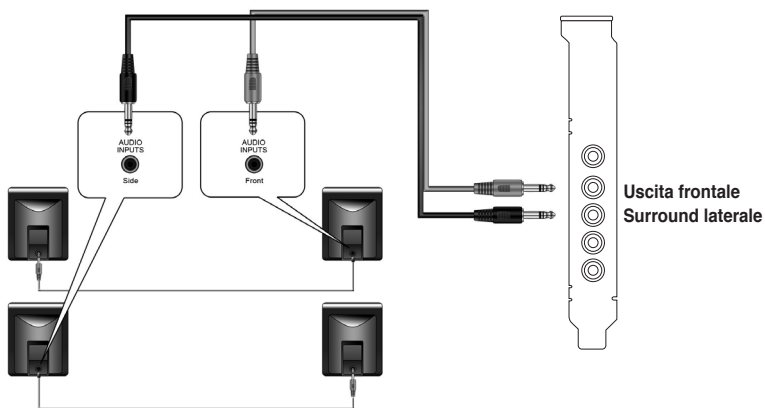

4.1 Casse

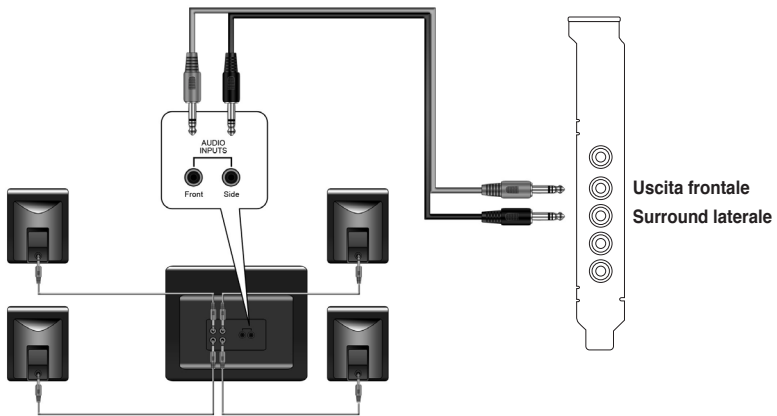

5.1 Casse

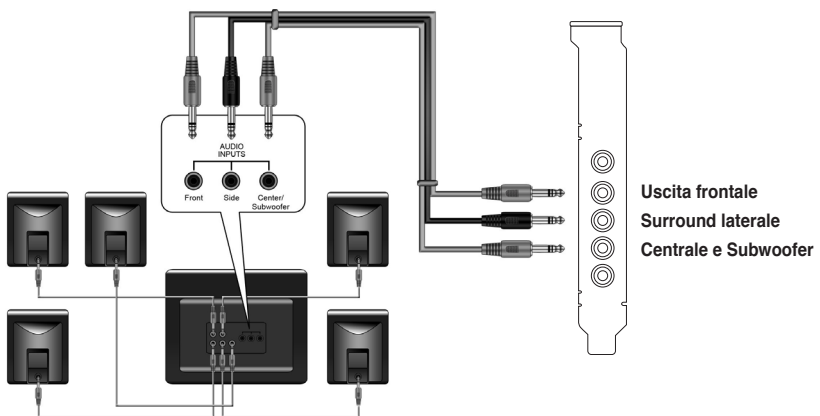

6.1 Casse

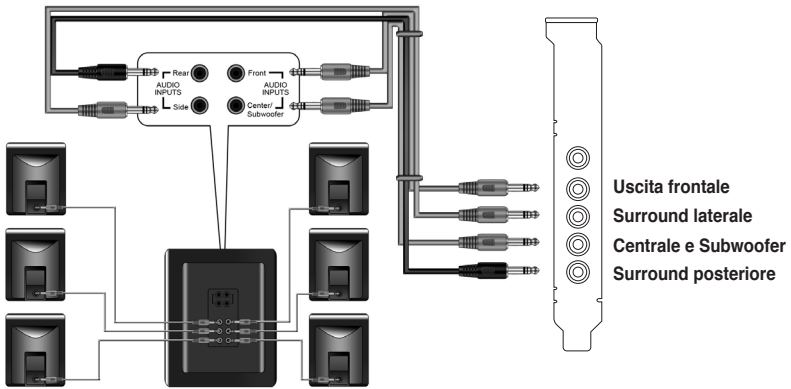

7.1 Casse

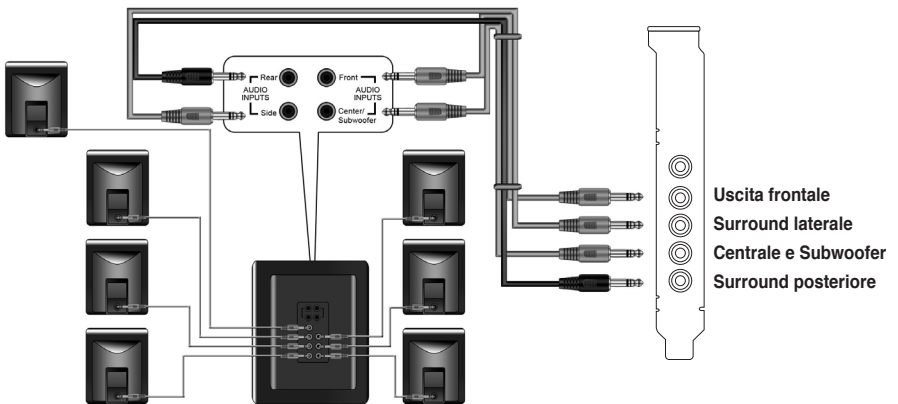

1.4.3 Connessione degli Altoparlanti Digitali

Uscita SPDIF

Collegare l'adattatore ottico TOSLINK al connettore combinato uscita S/PDIF. Poi, collegare la porta ingresso S/PDIF del decodificatore all'adattatore ottico usando un cavo ottico TOSLINK.



Si può anche usare un cavo coassiale per la connessione S/PDIF. Collegare il connettore maschio del cavo coassiale RCA al connettore combinato uscita S/PDIF-Out e collegare l'altra estremità all'input S/PDIF del decodificatore.

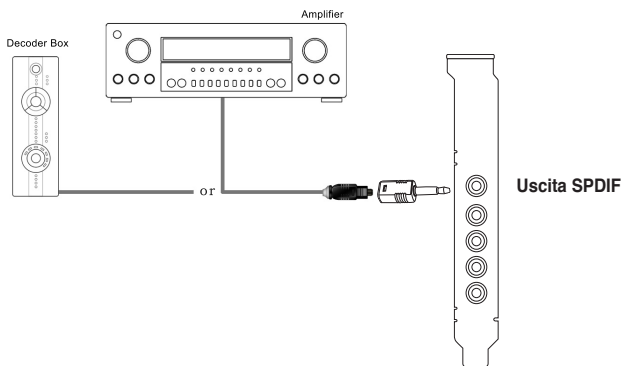

1.4.4 Connessione delle Sorgenti Audio Line-In

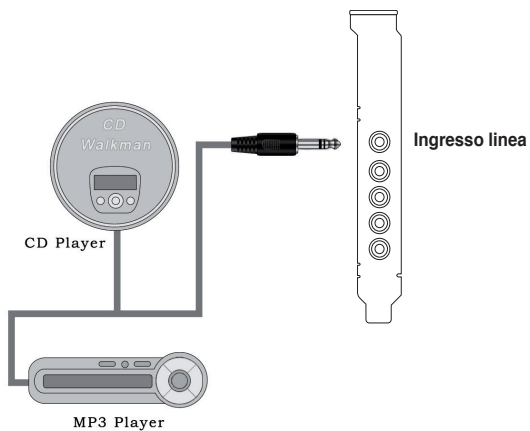

1.4.5 Collegamento delle cuffie / microfono

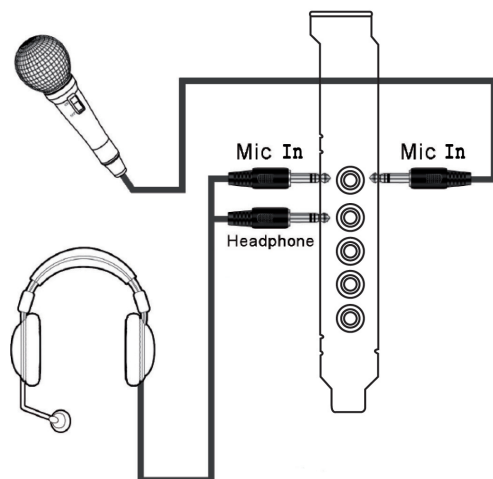



Xonar DX

Tarjeta de audio
PCI Express

Guía de instalación rápida

Español

1.1 Requisitos de instalación

Para garantizar la instalación correcta de la tarjeta de audio Xonar DX, su PC debe cumplir los siguientes requisitos:

- Tener una ranura compatible con PCI Express 1.0 (o superior) para la tarjeta de audio
- Disponer de un cable de alimentación de 4 contactos conectado a la fuente de alimentación de su PC
- Microsoft® Windows® Vista/XP (32 y 64 bits)/MCE2005
- Procesador Intel® Pentium® 4 a 1,4 GHz o AMD Athlon 1400, o un procesador más rápido
- Memoria de sistema DRAM de, al menos, 256 MB
- Espacio en disco duro de, al menos, 60 MB para el paquete de instalación del controlador; 200 MB como mínimo de espacio disponible para el programa Ableton Live y 320 MB como mínimo para el paquete Cakewalk
- Unidad de CD-ROM (o DVD-ROM) para instalar el software
- Auriculares de alta calidad, altavoces analógicos alimentados o altavoces digitales con decodificador Dolby Digital para disfrutar de los sonidos de muy alta fidelidad que proporciona la tarjeta

Antes de la instalación, compruebe que el paquete de la tarjeta de audio ASUS Xonar DX contiene los siguientes artículos:

- Tarjeta de audio ASUS Xonar DX
- CD de soporte ASUS Xonar DX (incluye las utilidades Portable Music Processor™ Lite y RMAA V6.0.6)
- Soporte de bajo perfil adicional
- Adaptador óptico TOSLINK S/PDIF x1•

Guía de instalación rápida

1.2 Instalación de la tarjeta

Para instalar la tarjeta de audio Xonar DX:

1. Toque el panel posterior o lateral metálico del equipo para descargar la electricidad estática.
2. APAGUE el equipo, el monitor y todos los dispositivos periféricos conectados al primero.
3. Desenchufe el cable de alimentación del equipo y de la toma de corriente eléctrica.
4. Retire la tapa del chasis.
5. Localice una ranura PCIE vacía en la placa base.
6. Conecte el cable de alimentación de la fuente de alimentación al conector de alimentación de la tarjeta de audio.
7. Alinee la tarjeta de audio e insértela en la ranura PCIW hasta que quede asentada en su lugar. Asegúrese de que los contactos alargados estén correctamente asentados en la ranura.
8. Asegure el tornillo del soporte que sujeta la tarjeta de audio en su lugar. Consulte la imagen siguiente para ver la ubicación del orificio del tornillo del soporte.
9. Vuelva a colocar la tapa del chasis.
10. Conecte de nuevo todos los cables.
11. Enchufe el cable de alimentación a su PC y a una toma de corriente eléctrica.
12. ENCIENDA el equipo.



La tarjeta de audio de alta calidad requiere alimentación adicional del equipo. Si el cable de alimentación no está correctamente conectado, la tarjeta de audio no funcionará.

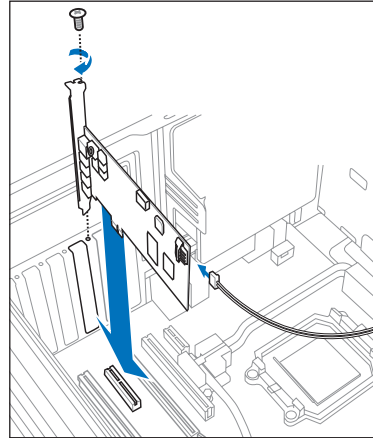

Cuando desenchufe el cable de alimentación de la tarjeta de audio Xonar DX, asegúrese de extraer primero la base de conexiones de 4 contactos y, a continuación, enchúfela desde el conector de alimentación tal y como se muestra en las imágenes siguientes. No retire la base de conexiones del conector de alimentación a la fuerza; si lo hace, ¡puede desprender dicho conector de la tarjeta de audio y dañarlo!

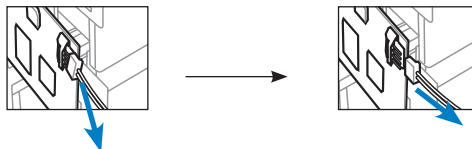

1.3 Instalación del controlador

Después de instalar la tarjeta de audio Xonar DX en el equipo, es necesario instalar el controlador del dispositivo que habilita a dicha tarjeta para trabajar con el sistema operativo Windows.



La versión y contenido del CD del controlador están sujetos a cambio sin previo aviso.

Si ya ha instalado la tarjeta de audio ASUS Xonar DX, puede aparecer la ventana Found New Hardware Wizard (Asistente para hardware nuevo encontrado) antes de la instalación del controlador o durante la misma. Consulte la figura siguiente.



1.3.1 Instalar el controlador de la tarjeta de audio

Para instalar el controlador del dispositivo:

1. En la ventana **Asistente para hardware nuevo encontrado**, haga clic en **Cancelar**.
2. Inserte el CD de soporte ASUS Xonar DX en la unidad óptica.
Si la función de ejecución automática está habilitada, aparecerá automáticamente la pantalla del controlador de la tarjeta ASUS Xonar. Siga con el paso 5.
Si la función de ejecución automática no está habilitada en el equipo, continúe con el paso 3.
3. Haga clic en **Mi PC** en el escritorio y, a continuación, doble clic en el icono de la unidad óptica.
4. Haga doble clic en el icono **setup.exe** ubicado en la unidad óptica.
5. Siga las instrucciones que aparezcan en la pantalla para completar la instalación. Lea el **“CONTRATO DE LICENCIA PARA EL USUARIO FINAL”** que aparecerá durante el proceso de instalación, asegúrese de que lo comprende y aceptelo antes de continuar.
6. Cuando la instalación finalice, se le puede pedir que reinicie el sistema. Si lo desea, puede reiniciar el sistema en otro momento.

1.4 Conectar dispositivos de audio

1.4.1 Puertos posteriores

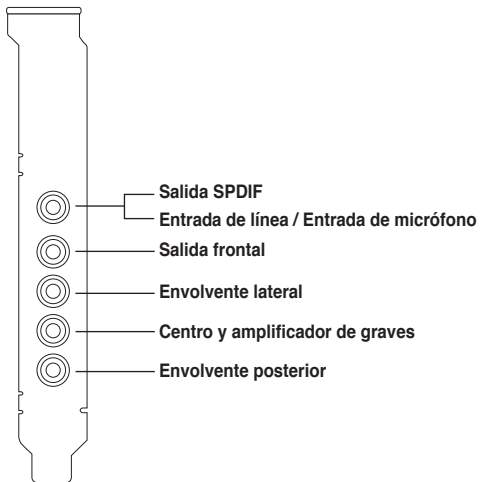

1.4.2 Conectar altavoces analógicos

2 altavoces

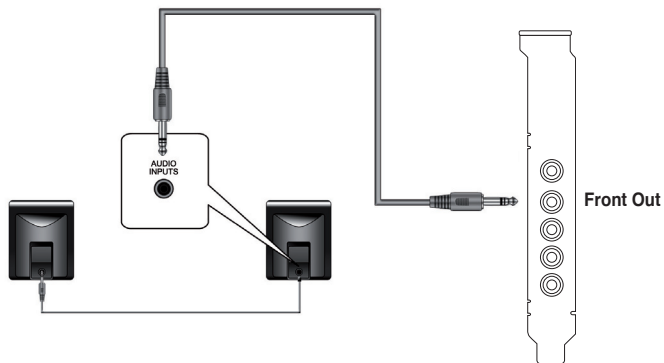

2.1 altavoces

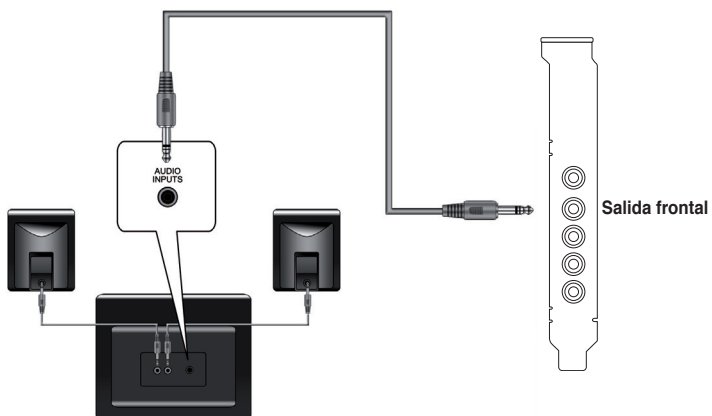

4 altavoces

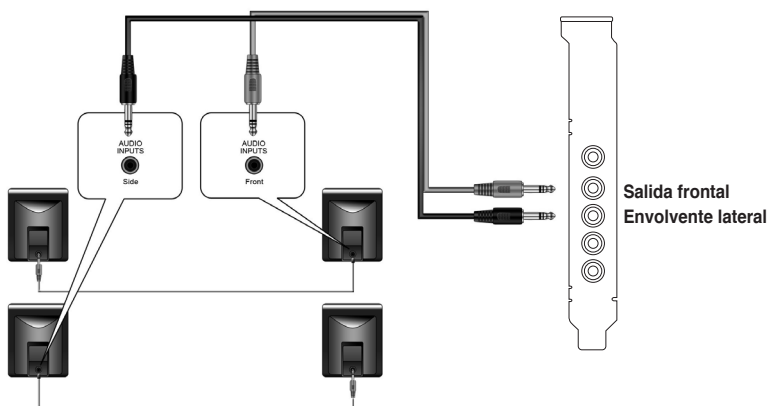

4.1 altavoces

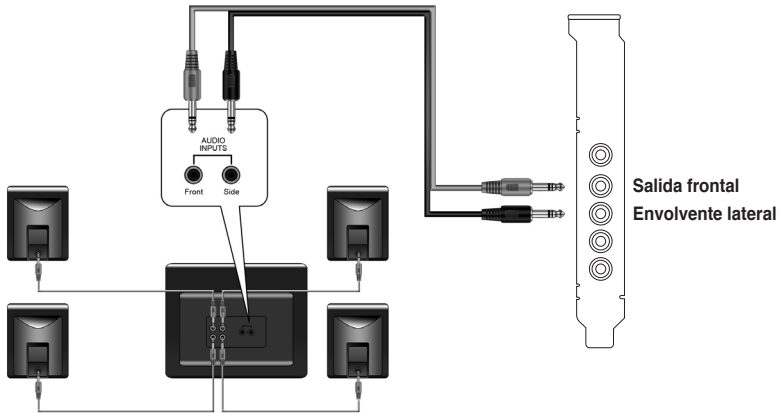

5.1 altavoces

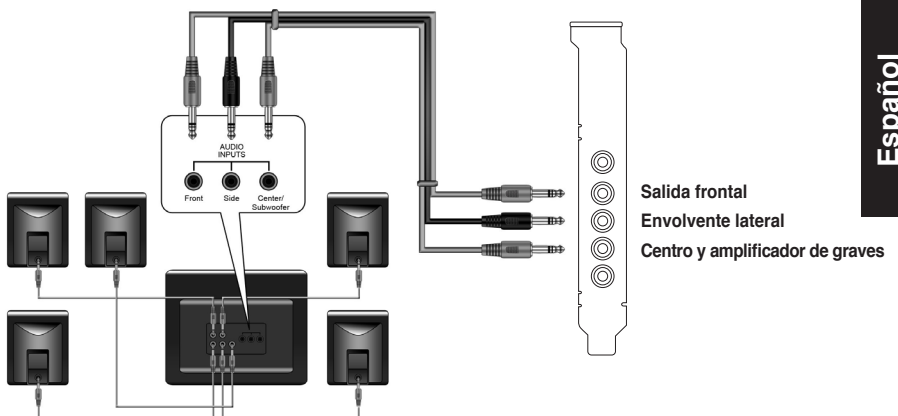

Español

6.1 altavoces

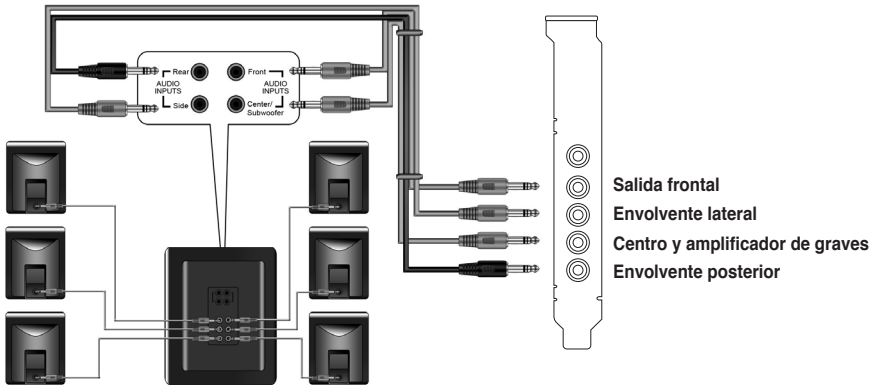

7.1 altavoces

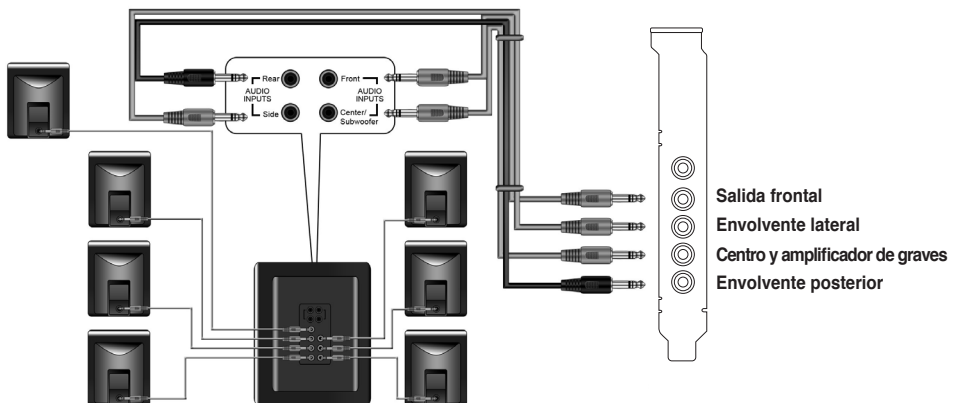

Español

1.4.3 Conectar altavoces digitales

Salida SPDIF

Enchufe el adaptador TOSLINK óptico en el conector combinado Salida S/PDIF. A continuación, conecte el puerto de entrada S/PDIF del descodificador al adaptador óptico con el cable óptico TOSLINK.



También puede usar un cable coaxial para una conexión S/PDIF. Simplemente enchufe el conector macho RCA coaxial en el conector combinado Salida S/PDIF y el otro extremo en la entrada S/PDIF coaxial del descodificador.

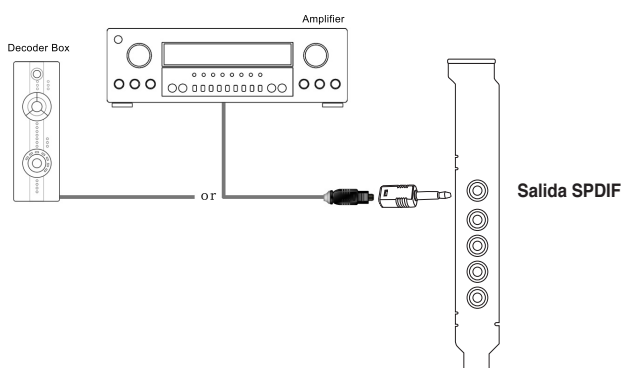

1.4.4 Conectar las fuentes de audio a la Entrada de línea

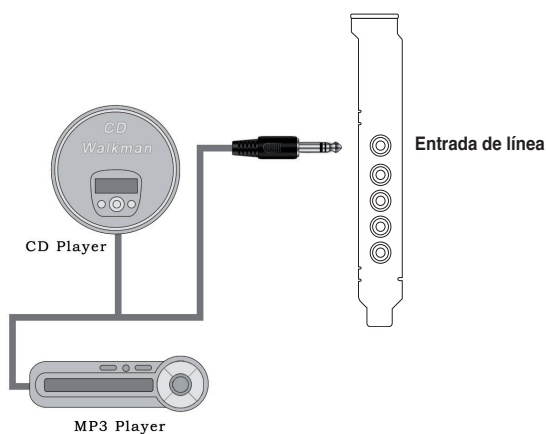

1.4.5 Conectar los auriculares y el micrófono

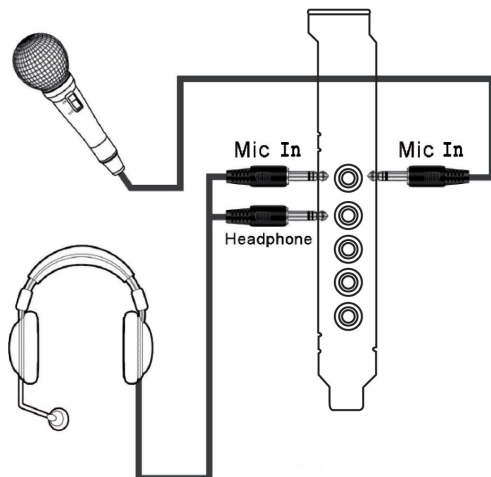



Xonar DX

Placa de áudio
PCI Express

Guia de instalação rápida

1.1 Requisitos para a instalação

Para garantir uma correcta instalação da placa de áudio Xonar DX, o seu computador deve satisfazer os seguintes requisitos:

- Uma ranhura PCI Express 1.0 (ou acima) compatível para a placa de áudio
- Um cabo de alimentação de 4 pinos para a fonte de alimentação do PC
- Microsoft® Windows® Vista/XP (32/64 bits)/MCE2005
- CPU Intel® Pentium® 4 de 1,4 GHz ou AMD Athlon 1400 ou acima
- > 256 MB de memória DRAM
- > 60 MB de espaço disponível no disco rígido para instalação do controlador; >200 MB de espaço disponível para o Ableton Live e >320 MB para o Cakewalk
- Unidade de CD-ROM (ou de DVD-ROM) para instalação do software
- Auscultadores de alta qualidade, altifalantes analógicos ou digitais com decodificadores Dolby Digital para poder desfrutar de um som de ultra alta fidelidade

Antes da instalação, verifique se os itens seguintes constam da embalagem da placa de áudio Xonar DX da ASUS:

- Placa de áudio Xonar DX da ASUS
- CD de suporte da placa de áudio Xonar DX da ASUS (incluindo os utilitários Portable Music Processor™ Lite e RMAA V6.0.6)
- Suporte adicional discreto
- Adaptador óptico S/PDIF TOSLINK x1
- Guia de instalação rápida

1.2 Instalação da placa

Para instalar a placa de áudio Xonar DX da ASUS:

1. Toque na parte metálica traseira ou no painel lateral do computador para evitar a electricidade estática.
2. Desligue o computador, o monitor e todos os outros periféricos ligados ao computador.
3. Desligue o cabo de alimentação do computador do próprio computador e da tomada eléctrica.
4. Remova a tampa do computador.
5. Na placa principal, procure uma ranhura PCIE disponível.
6. Ligue o cabo da fonte de alimentação ao conector de alimentação da placa de áudio.
7. Alinhe a placa de áudio com a ranhura PCIE e introduza-a na ranhura até ficar devidamente encaixada. Certifique-se de que os módulos do tipo “gold fingers” são devidamente introduzidos na ranhura.
8. Aperte o parafuso do suporte da placa de áudio para que esta fique devidamente posicionada. Consulte a imagem seguinte para saber onde fica o orifício do parafuso do suporte da placa.
9. Reponha a tampa do computador.
10. Volte a ligar todos os cabos.
11. Ligue o cabo de alimentação ao computador e à tomada eléctrica.
12. Ligue o computador.



A placa de áudio PCI Express requer alimentação adicional proveniente do seu computador. Se o cabo de alimentação não estiver correctamente ligado, a placa de áudio não funcionará.

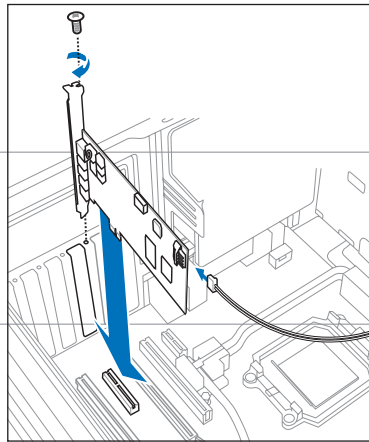

Ao remover o cabo de alimentação da placa de áudio Xonar DX, certifique-se de que puxa primeiro pelo conector de 4 pinos desligando-o depois do conector de alimentação tal como mostram as imagens seguintes. Não force a remoção do conector pois se o fizer pode danificar a placa de áudio!

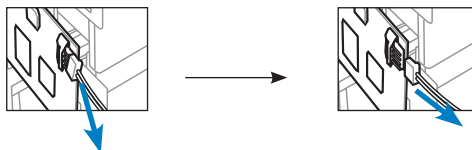

1.3 Instalação do controlador

Após a instalação da placa de áudio Xonar DX no computador, tem de instalar o controlador que permite à placa Xonar DX funcionar no sistema operativo Windows.



A versão e o conteúdo do CD do controlador estão sujeitos a alterações sem aviso prévio.

Caso tenha já instalado a placa de áudio Xonar DX da ASUS, a janela Assistente de novo hardware encontrado pode aparecer antes da ou durante a instalação do controlador. Consulte a figura em baixo.

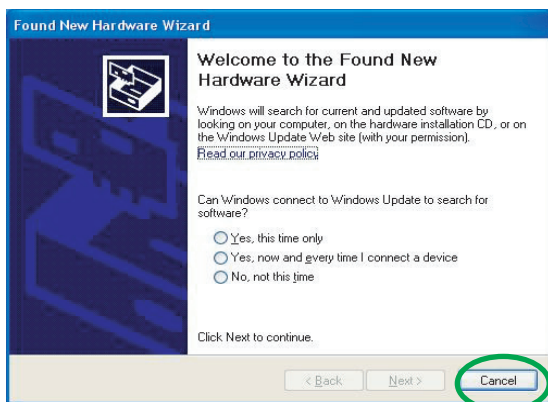

1.3.1 Instalação do controlador da placa de áudio

Para instalar o controlador da placa:

1. Clique em **Cancelar** na janela **Assistente de novo hardware encontrado**.
2. Introduza o CD de suporte da placa Xonar DX da ASUS na unidade óptica.
Se o modo de execução automática estiver activado, o ecrã Controlador da placa Xonar da ASUS é apresentado automaticamente. Passe para a etapa 5.
Se o modo de execução automática não estiver activado no computador, execute o procedimento descrito na etapa 3.
3. Clique sobre o ícone “**O meu computador**” existente no ambiente de trabalho e faça um duplo clique sobre o ícone da unidade óptica.
4. Faça um duplo clique sobre o ícone do ficheiro **setup.exe** na unidade óptica.
5. Siga as instruções no ecrã para concluir a instalação. Leia o documento “**Acordo de licença do utilizador final**” e certifique-se de que o compreende e aceita antes de prosseguir com a instalação.
6. Quando a instalação fica concluída, pode-lhe ser pedido para reiniciar o computador. Pode optar por reiniciar o computador mais tarde se assim o desejar.

1.4 Ligação do dispositivo de áudio

1.4.1 Portas traseiras

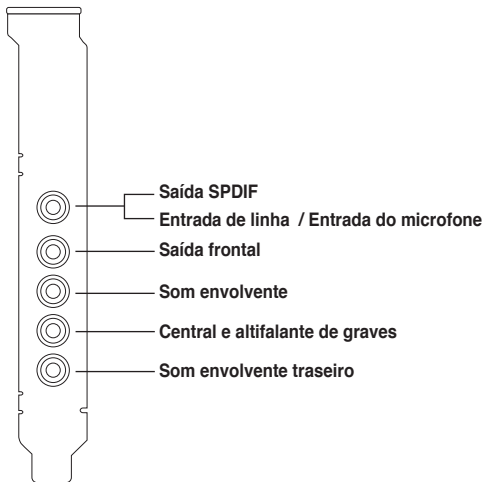

1.4.2 Ligação dos altifalantes analógicos

Altifalantes de canal 2

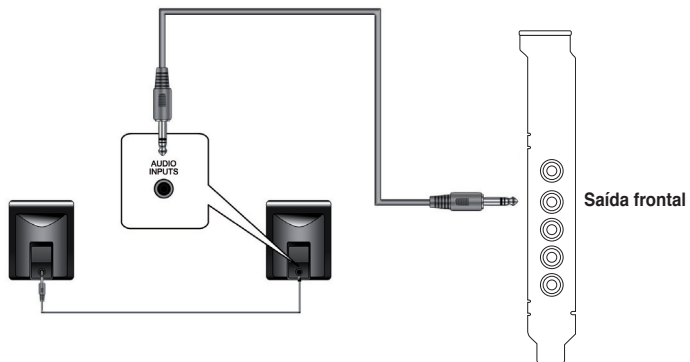

Altifalantes de canal 2.1

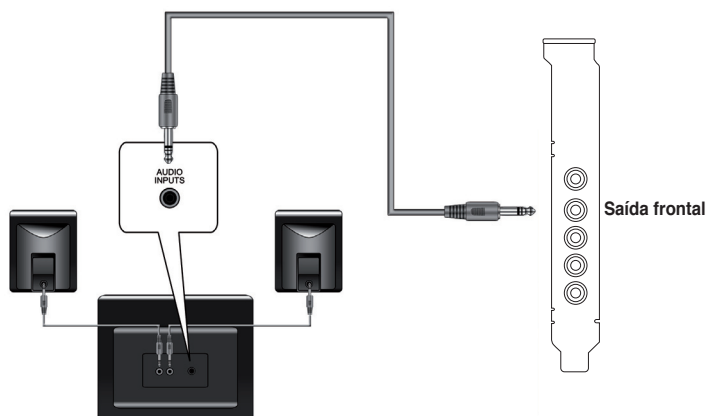

Altifalantes de canal 4

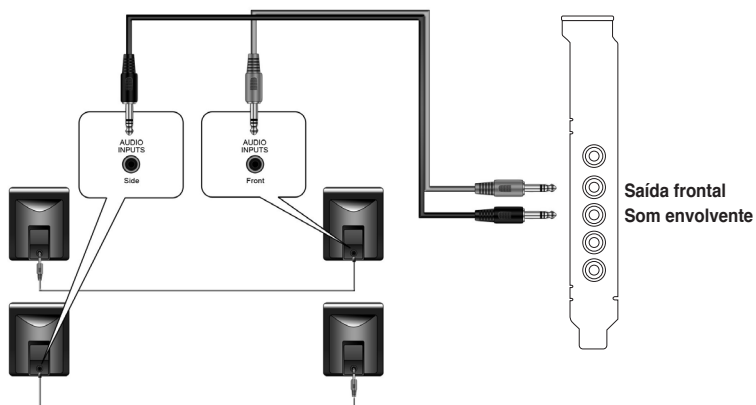

Altifalantes de canal 4.1

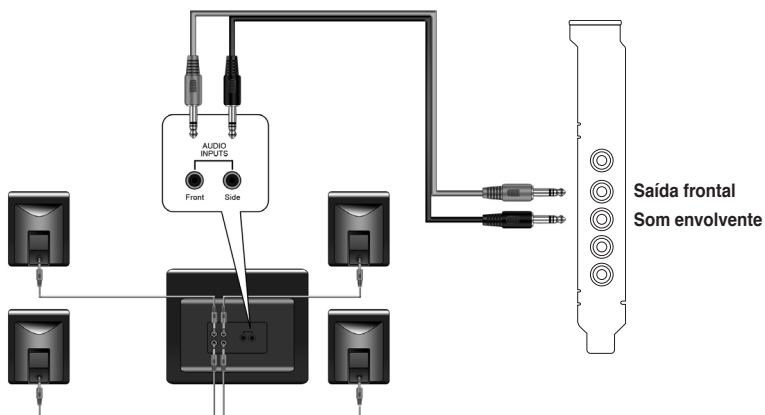

Altifalantes de canal 5.1

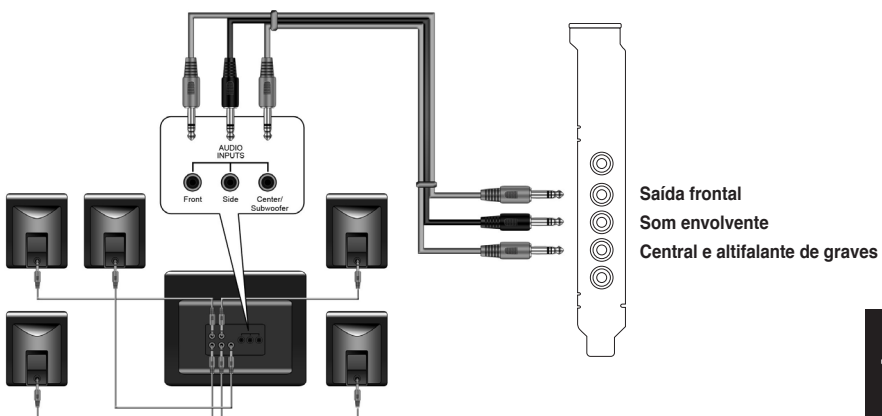

Altifalantes de canal 6.1

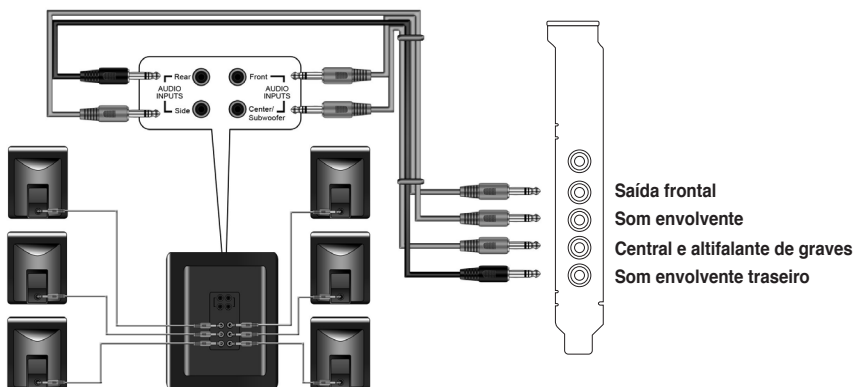

Altifalantes de canal 7.1

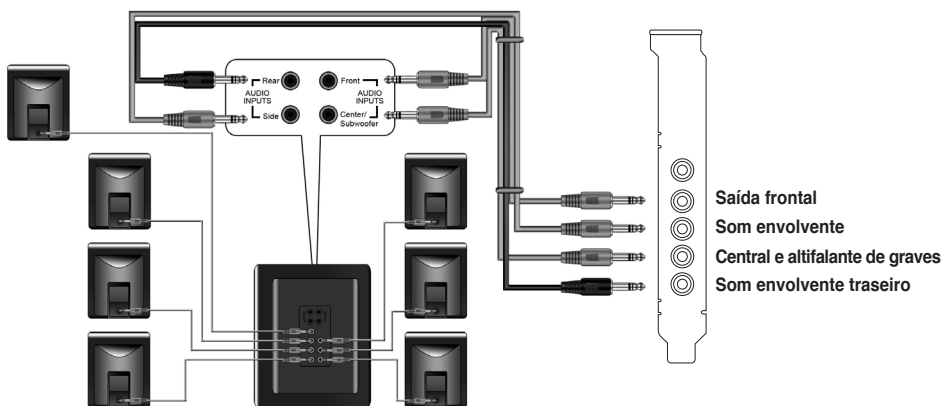

1.4.3 Ligação dos altifalantes digitais

Saída SPDIF

Ligue o adaptador óptico TOSLINK ao conector combinado de saída S/PDIF. Depois faça a ligação entre a porta de entrada S/PDIF e o adaptador óptico utilizando o cabo óptico TOSLINK.



Pode também utilizar um cabo coaxial para fazer a ligação S/PDIF. Basta ligar o conector RCA coaxial macho ao conector combinado de saída S/PDIF e ligar a outra extremidade à entrada S/PDIF coaxial existente no descodificador.

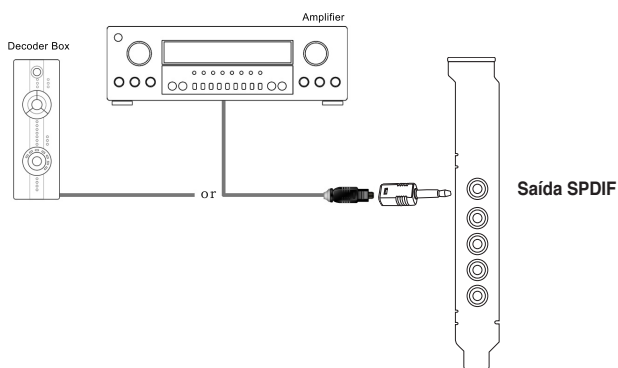

1.4.4 Ligação das origens de entrada de áudio

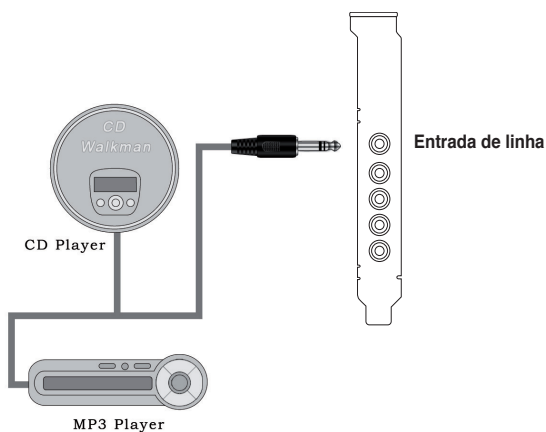

1.4.5 Ligação dos auscultadores / do microfone

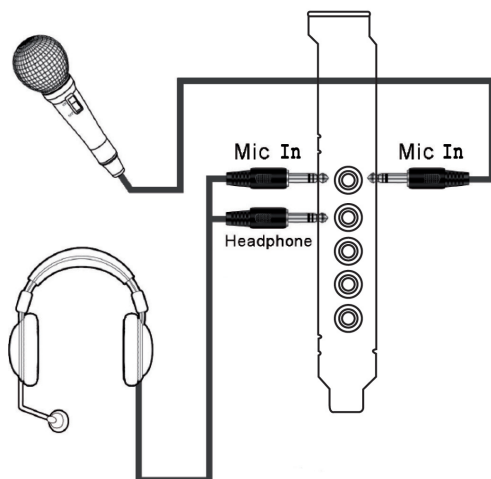



Хonar DX

PCI Express аудиокарта

Руководство по установке

1.1 Требования для установки

Для успешной установки аудиокарты Xonar D2, ваш компьютер должен соответствовать следующим требованиям:

- Один свободный слот PCI Express 1.0 (или выше)
- Один свободный 4-контактный кабель питания от блока питания ПК
- Microsoft® Windows® Vista/XP(32/64бит)/MCE2005
- Процессор Intel® Pentium® 4 1.4МГц или AMD K7 1400 или более быстрый
- Память более 256 Мб
- Более 60 Мб свободного дискового пространства для установки драйверов; Более 200Мб доступного пространства для Ableton Live и более 320Мб для пакета Cakewalk
- CD-ROM (DVD-ROM) привод для установки программного обеспечения
- Высококачественные наушники, мощные аналоговые колонки или цифровые колонки с декодером Dolby Digital для прослушивания звука

Перед установкой проверьте комплектность ASUS Xonar D2:

- Аудиокarta ASUS Xonar DX
- Компакт-диск ASUS Xonar DX (включая утилиты Portable Music Processor™ Lite и RMAA V6.0.6)
- **Дополнительный кнонштейн**
- S/PDIF TOSLINK оптический переходник x1 • **Руководство по установке**

1.2 Установка карты

Для установки аудиокарты ASUS Xonar выполните следующее:

1. Для сброса статического электричества коснитесь металлической задней или боковой стенки компьютера.
2. Выключите ваш ПК, монитор и все другие периферийные устройства, подключенные к вашему ПК.
3. Отключите шнур питания.
4. Снимите крышку корпуса.
5. Найдите свободный PCI-Express слот на материнской плате.
6. Подключите кабель от блока питания к разъему питания на аудиокарте
7. Совместите Xonar карту с разъемом и надавите, пока карта не встанет на место. Убедитесь, что карта надежно вставлена в слот.
8. Закрутите винт, крепящий аудиокарту Xonar D2. Для нахождения отверстия винта обратитесь к рисунку внизу.
9. Закройте крышку корпуса.
10. Подключите все кабели.
11. Подключите шнур питания к компьютеру и розетке
12. Включите компьютер.



PCI Express аудиокарте требуется дополнительное питание. Если кабель питания не подключен, аудиокарта не будет работать..

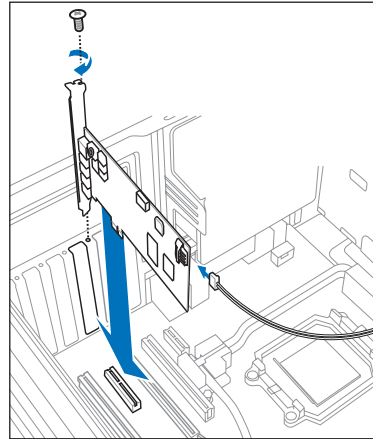

При отключении кабеля питания от аудиокарты Xonar DX audio card, сначала потяните 4-контактный разъем наружу, затем отключите его от разъема питания, как показано на рисунке. При отключении не применяйте чрезмерные усилия; поступая таким образом можно повредить разъем питания на аудиокарте!

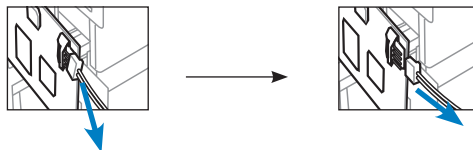

1.3 Установка драйверов

После установки аудиокарты Xonar D2 в ваш компьютер, вам нужно установить драйвера, которые позволят аудиокарте Xonar D2 работать в операционной системе Windows.



Версия и содержимое драйвера на компакт-диске изменяются без уведомления.

Если вы уже установили аудиокарту ASUS Xonar D2, перед установкой драйвера может появиться окно мастера нового оборудования. Смотрите рисунок внизу.



1.3.1 Установка драйверов аудиокарты

Для установки драйверов устройства выполните следующее:

1. В окне **Found New Hardware wizard** нажмите **Cancel**.
2. Вставьте компакт-диск ASUS Xonar D2 в оптический привод.
Если автозапуск включен, автоматически появится экран ASUS Xonar Card Driver. Перейдите к шагу 5.
Если автозапуск отключен на вашем компьютере, выполните шаг 3.
3. На рабочем столе щелкните **My Computer** и дважды щелкните на иконке оптического привода.
4. Дважды щелкните на файле **setup.exe** на компакт-диске.
5. Следуйте инструкциям на экране для завершения установки. В процессе установки прочитайте **“END USER LICENSE AGREEMENT”**, убедитесь, что вы понимаете и принимаете это перед продолжением установки.
6. При завершении установки, вас попросят перезагрузить ваш компьютер. Если желаете, вы можете перезагрузить компьютер позже.

1.4 Подключение аудиоустройств

1.4.1 Порты

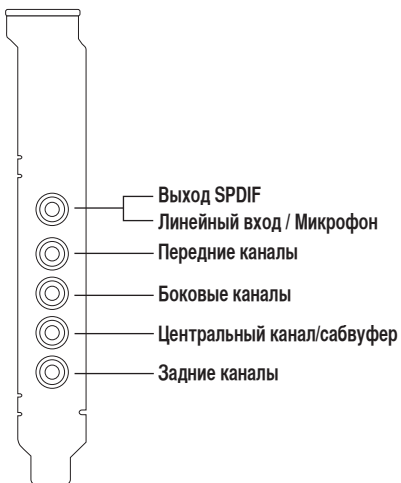

1.4.2 Подключение аналоговых колонок

2 колонки

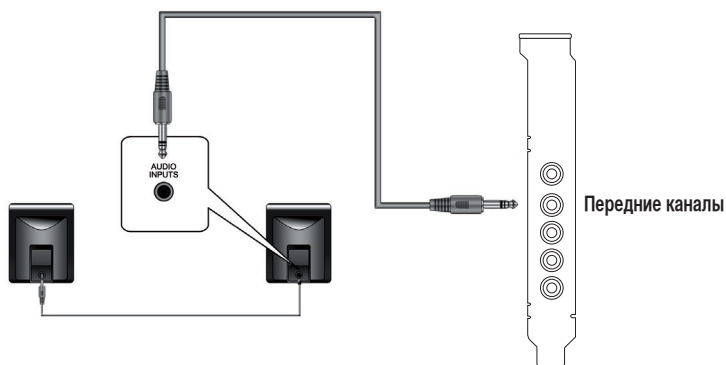

2.1 колонки

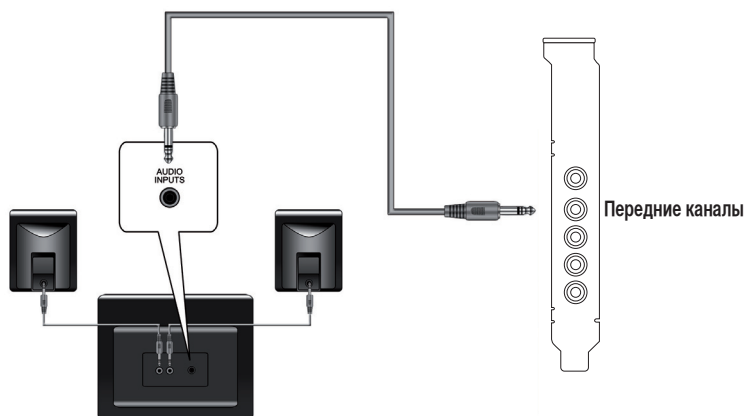

4 колонки

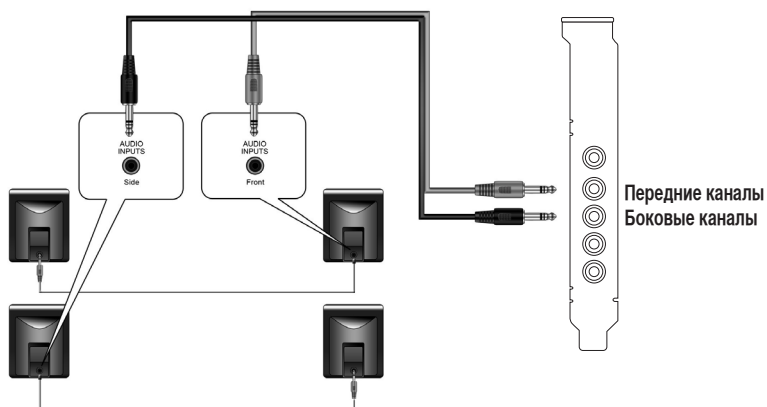

4.1 колонки

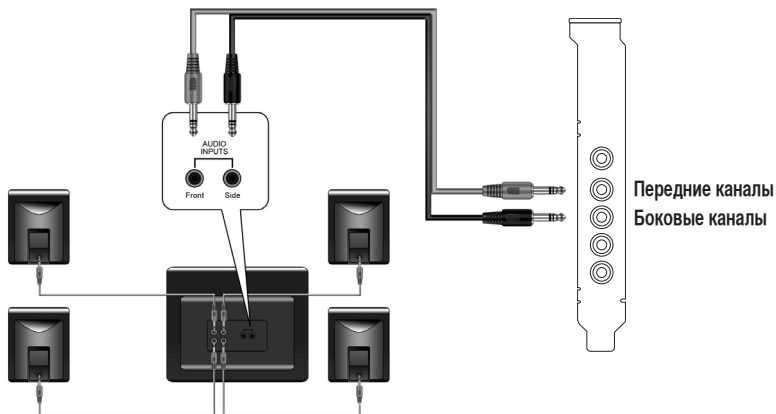

5.1 колонок

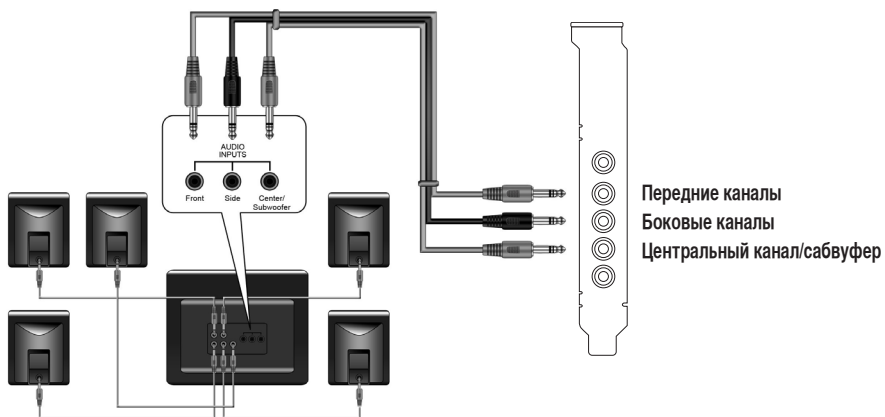

6.1 колонок

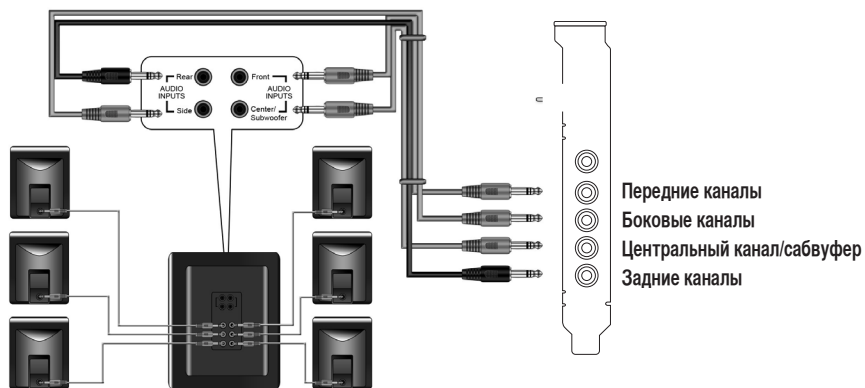

7.1 колонок

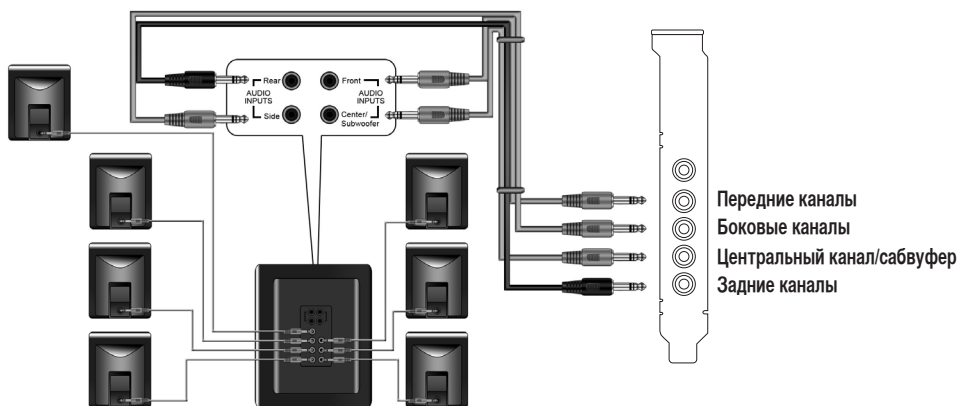

1.4.3 Подключение цифровых колонок

SPDIF Out

Подключите оптический адаптер TOSLINK к разъему combo S/PDIF-Out. Затем, подключите разъем S/PDIF-In вашего декодера к оптическому адаптеру TOSLINK с помощью оптического кабеля.



Также для соединения S/PDIF вы тоже можете использовать коаксиальный кабель. Просто подключите один конец коаксиального кабеля к разъему combo S/PDIF-Out и подключите другой конец к коаксиальному разъему S/PDIF-In вашего декодера.

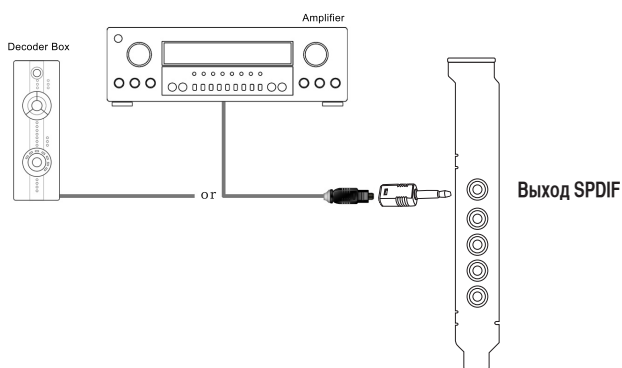

1.4.4 Подключение источника звука к линейному входу

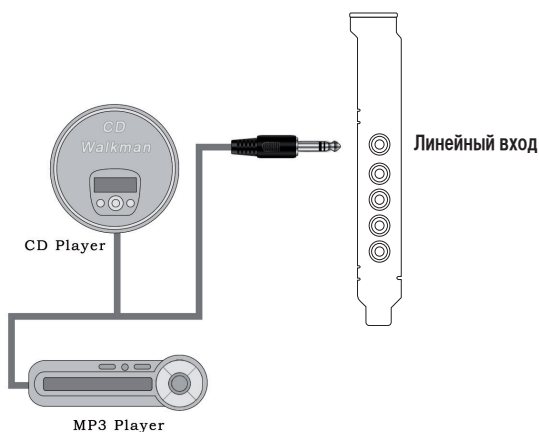

1.4.5 Подключение наушников / микрофона

